

Powered Loudspeaker Management™ System



PLM 20K44
PLM 12K44
PLM 5K44

Incorporating technologies from



1. Important safety instructions

Before using the device, be sure to carefully read the Safety Instructions. Keep this document with the device at all times.

1. Read these instructions.
2. Keep these instructions
3. Heed all warnings.
4. Follow all instructions.
5. Do not use this apparatus near water.
6. Clean only with a dry cloth.
7. Do not block any ventilation openings. Install in accordance with the manufacturer's instructions.
8. Do not install near any heat sources such as radiators, heat registers, stoves, or other apparatus (including amplifiers) that produce heat.
9. Do not defeat the safety purpose of the polarized or grounding-type plug. A polarized plug has two blades with one wider than the other. A grounding-type plug has two blades and a third grounding prong. The wide blade or the third prong is provided for your safety. If the provided plug does not fit into your outlet, consult an electrician for replacement of the obsolete outlet.
10. Protect the power cord from being walked on or pinched, particularly at plugs, convenience receptacles, and the point where they exit from the apparatus.
11. Only use attachments/accessories specified by the manufacturer.
12. Use only with a cart, stand, tripod, bracket, or table specified by the manufacturer, or sold with the apparatus. When a cart is used, use caution when moving the cart/apparatus combination to avoid injury from tip-over.
13. Unplug this apparatus during lightning storms or when unused for long periods of time.
14. Refer all servicing to qualified service personnel. Servicing is required when the apparatus has been damaged in any way, such as power-supply cord or plug is damaged, liquid has been spilled or objects have fallen into the apparatus, the apparatus has been exposed to rain or moisture, does not operate normally, or has been dropped.
15. Use the mains plug to disconnect the apparatus from the mains.
16. **WARNING:** To reduce the risk of fire or electric shock, do not expose this apparatus to rain or moisture.
17. Do not expose this equipment to dripping or splashing and ensure that no objects filled with liquids, such as vases, are placed on the equipment.
18. The mains plug of the power supply cord shall remain readily operable.
19. Do not connect the unit's output to any other voltage source such as battery, mains source, or power supply, regardless of whether the unit is turned on or off.
20. Do not remove the top (or bottom) cover. Removal of the cover will expose hazardous voltages. There are no user serviceable parts inside and removal may void the warranty.
21. An experienced user shall always supervise this professional audio equipment, especially if inexperienced adults or minors are using the equipment.
22. The US National Differences clause 16.3 requires that network cables must be flame rated VW-1.

1.1. Approvals



This equipment conforms to the requirements of the EMC Directive 2004/108/EC and the requirements of the Low Voltage Directive 2006/95/EC.

Standards applied: EMC Emission EN55103-1, E3
EMC Immunity EN55103-2, E3, with S/N below 1% at normal operation level.
Electrical Safety EN60065, Class I



This equipment is tested and listed according to the U.S. safety standard ANSI/UL 60065 and Canadian safety standard CSA C22.2 NO. 60065. Intertek made the tests and they are a Nationally Recognized Testing Laboratory (NRTL).

1.2. Warnings

1.2.1. Explanation of warning symbols



The lightning bolt triangle is used to alert the user to the presence of un-insulated "dangerous voltages" within the unit's chassis that may be of sufficient magnitude to constitute a risk of electric shock to humans.



The exclamation point triangle is used to alert the user to presence of important operating and service instructions in the literature accompanying the product.

1.2.2. Warnings

To prevent electric shock do not remove top or bottom covers. No user serviceable parts inside, refer servicing to qualified service personnel.

Français: À prévenir le choc électrique n'enlevez pas les couvercles. Il n'y a pas des parties serviceable à l'intérieur, tous reparations doit être faire par personnel qualifié seulement.



 To completely disconnect this equipment from the AC mains, disconnect the power supply cord plug from the AC receptacle. The mains plug of the power supply cord shall remain readily operable.

Français: Pour démonter complètement l'équipement de l'alimentation générale, démonter le câble d'alimentation de son réceptacle. La prise d'alimentation restera aisément fonctionnelle.

 To reduce risk of fire or electric shock, do not expose this apparatus to rain or moisture.

Français: Pour réduire les risques d'incendie ou de choc électrique, n'exposez pas l'appareil à la pluie ou à l'humidité.

 Do not expose this system/apparatus to dripping or splashing and ensure that no objects filled with liquids, such as vases, are placed on the apparatus.

Français: N'exposez pas ce système/appareil au ruissellement ni aux éclaboussures et assurez-vous qu'aucun objet contenant du liquide tel qu'un vase n'est placé sur l'appareil.

 This apparatus must be connected to a mains socket outlet with a protective earthing connection.

Français: Cet appareil doit être raccordé à une prise secteur avec terre de protection.

 The mains plug is used as a disconnect device and shall remain readily operable.

Français: Lorsque la prise du réseau d'alimentation est utilisée comme dispositif de déconnexion, ce dispositif doit demeurer aisément accessible.

1.2.3. Caution

 To reduce the risk of fire or electric shock, do not remove screws. No user-serviceable parts inside. Refer servicing to qualified service personnel.

Français: Pour réduire le risque d'incendie ou de choc électrique, ne pas retirer les vis. Aucune pièce réparable par l'utilisateur. Confier l'entretien à personnel qualifié.

1.2.4. User responsibility

Mains connection grounding

Your amplifier must be connected to a grounded socket outlet.

Speaker output hazard on amplifiers

Amplifiers are capable of producing hazardous output voltages. To avoid electrical shock, do not touch any exposed speaker wiring while the amplifier is operating. The external wiring connected to the speaker terminals shall be installed by a qualified person, or ready-made leads or cords of appropriate capacity shall be used.

As the power output channels on amplifiers produce high voltage, do not connect or disconnect speaker cables when the mains power is on.

Radio interference

A sample of this product has been tested and complies with the limits for the European Electro Magnetic Compatibility (EMC) directive. This equipment has also been tested and found to comply with the limits for a Class A digital device, pursuant to Part 15 of the FCC Rules. These limits are designed to provide reasonable protection against harmful interference from electrical equipment. This product uses radio frequency energy and if not used or installed in accordance with these operating instructions, may cause interference to other equipment, such as radio receivers.

This Class A digital apparatus complies with Canadian ICES-003.
Cet appareil numérique de la classe A est conforme à la norme NMB-003 du Canada.

However, there is no guarantee that interference will not occur in a particular installation. If this equipment does cause harmful interference to radio or television reception, which can be determined by turning the equipment on and off, the user is encouraged to try to correct the interference by one or more of the following measures:

- Reorient or relocate the antenna.
- Increase the separation between the equipment and receiver.
- Connect the equipment to an outlet on a circuit different from that to which the receiver is connected.
- Check if the affected unit complies with the EMC limits for immunity, (CE-labeled). If not, address the problem with the manufacturer or supplier. All electrical products sold in the EC must be approved for immunity against electromagnetic fields, high voltage flashes, and radio interference.
- Consult the dealer or an experienced radio/TV technician for help.

Speaker damage

Amplifier apparatus is very powerful and can be potentially dangerous to both loudspeakers and humans alike. Many loudspeakers can be easily damaged or destroyed by overpowering them. Always check the speaker's continuous and peak power capabilities. Although the amplifiers attenuators can be used to reduce the overall gain, an increase of the input signal can result in full output power, which may cause damage to connected speakers.

Maintenance

For safe and reliable operation, the dust filters on both sides of the front panel, behind the grilles, should be removed and cleaned regularly to ensure maximum airflow through the device.

If the dust filters are not maintained there will be safety risks; for example, high internal temperatures could ignite the dust and start a fire. There is also a risk that the unit will malfunction since it is dependent on constant airflow from front to rear. If the dust filters are not clean and the unit malfunctions, any resulting problems will not be covered by the warranty.

Table of Contents

1. Important safety instructions	2
1.1. Approvals	2
1.2. Warnings	2
2. Introduction	6
2.1. Welcome	6
2.2. Main Features	6
2.3. Additional Documentation	8
3. Installation	8
3.1. Unpacking	8
3.2. Mounting	8
3.3. Cooling	10
3.4. Operating Voltage	10
3.5. Grounding	11
4. Product Overview	12
4.1. Front Panel Overview	12
4.2. Rear panel	14
5. Operation and performance	16
5.1. Operation precautions	16
5.2. Power output performance	16
5.3. Amplifier and Load Protection Systems	18
5.4. Power Supply	24
5.5. LoadPilot Load Monitoring	25
5.6. Audio over Ethernet	27
6. Signal Flow and Lake® Processing	29
6.1. Signal Flow	29
6.2. Level Adjustments & Mute Points	30
6.3. Lake Processing and Control	31
6.4. Modules and Frames	31
6.5. Loudspeaker Processor Overview	32
6.6. Files and Presets	32
7. Front Panel Interface	33
7.1. Overview	33
7.2. Front Panel Key Lock	34
7.3. Power Button	34

7.4. Mute Enable Button	35
7.5. Meter Button	35
7.6. Menu Button	35
7.7. Exit Button	35
7.8. Dynamic Buttons, Controls and LEDs	36
7.9. Warning and Fault Indications	41
7.10. Meter Mode	43
7.11. Menu Mode	47
8. Back Panel Interface	61
8.1. Speaker Outputs	61
8.2. Analog Inputs	64
8.3. AES3 Digital Inputs	66
8.4. RJ45 etherCON Network Connections	66
8.5. Power Inlet	68
9. Appendix	69
9.1. Faults and Warnings Overview	69
9.2. Maintenance	72
9.3. Factory Default Settings	72
9.4. Current Draw and Thermal Dissipation Specifications	74
9.5. Glossary of Terms, Acronyms and Abbreviations	77
10. Application Guide	79
10.1. Rack I/O Panels	79
10.2. Gain Structure	79
10.3. Gain / Level Optimization	80
10.4. Speaker Configurations	83
10.5. Digital Audio Connections	84
10.6. Digital Clock Configuration	87
11. Technical Specifications	89
12. Warranty and Support	91
12.1. General	91
12.2. International Warranties	91
12.3. Technical Assistance and Service	91

2. Introduction

2.1. Welcome

Thank you for choosing the Lab.gruppen PLM+ Series of Powered Loudspeaker Management systems for your sound reinforcement needs. We are confident that you will be pleased with the performance, unique features, configuration flexibility, reliability, and long-term durability offered by this product.

For fast installation and use of this product, your welcome package includes a printed copy of the PLM+ Series Quick Start Guide which contains the information required to safely install the product and place it in service. Control and editing features are accessible via the front panel interface or via the included Lake Controller software.

It is recommended that the Quick Start Guide and all product documentation is reviewed to ensure familiarity with the various configuration and control options.

Thank you again for placing your confidence in Lab.gruppen products.

2.2. Main Features

The PLM+ Series incorporates a number of sophisticated technologies to ensure the best possible performance and many years of reliable operation. The following section summarizes the benefits of each feature.

2.2.1. Amplifier Platform

The PLM+ 20K44 and 12K44 amplifiers feature four channels of Lab.gruppen's unique and patented Class TD[®] output stages, and high-efficiency Intercooler[®] copper-finned cooling system. The PLM5K44 uses a newly developed Class D technology design with increased efficiency and sustained sonic performance. All models have a regulated Switch Mode Power Supply (R.SMPS[™]) with unparalleled Power Factor Correction (PFC) extremely close to one, and a full suite of protection features including the Breaker Emulation Limiter (BEL).

The PLM+ Series also incorporates Lab.gruppen's exclusive Rational Power Management (RPM), which allows exceptional flexibility in allocating power output across each channel for the most efficient use of amplifier inventory. Any channel in either model is capable of delivering higher outputs than the average 25% of the total power.

RPM works in conjunction with the new CAFÉ (Configuring Amplifiers For the Environment) software/firmware package, which includes ESP[™] (Equipment Specification Predictor) which assists in optimizing amplifier requirements for touring loudspeaker systems.

2.2.2. Amplifier DSP (Digital Signal Processor)

Various features of PLM+ Series devices are controlled by the on-board DSP, some of which are summarized in this section.

2.2.2.1. Amplifier Gain

Amplifier Gain is set in the digital domain for PLM+ Series devices, and may be controlled via the Lake Controller software or front-panel interface.

2.2.2.2. ISVPL™

The Inter-Sample Voltage Peak Limiter (ISVPL) tailors each power output to the characteristics of the connected load. Please refer to section 5.3.1 for further information.

2.2.2.3. Load Verification & Performance Monitoring

A comprehensive set of proprietary DSP-based tools are provided for load verification and real-time performance monitoring. These functions utilize Fingerprint files available for some loudspeaker presets in the Lake LoadLibrary. The LoadLibrary compiles a comprehensive database for each loudspeaker component of the connected load, usually one or more band-limited drivers in a multi-way system.

2.2.3. Lake Processing and Controller

PLM+ Series devices integrate seamlessly into the Lake Processing environment and are accessible via the Lake Controller software. Processing modules offer precise settings for gain, delay, crossover settings, equalization and limiting. Lake processing features incorporated in each module include Raised Cosine Equalization™, linear phase crossovers, and LimiterMax™ loudspeaker protection. Please refer to the Lake Controller Operation Manual for further information.

2.2.4. Analyzer Plug-in

Lake Controller software provides integration with third-party real-time analyzers, providing simultaneous measurement display and EQ adjustment via the Lake Controller. Approved analyzers include Rational Acoustics Smaart 7, SysTune from AMFG, and WaveCapture Live-Capture Light or Live-Capture Pro; additional third-party analyzers may be approved in the future.

Please refer to the Lake Controller Operation Manual for further information regarding the Analyzer plug-in and associated functionality.

2.2.5. Dante™ Audio Network

PLM+ Series devices include Dante digital audio networking as standard. Utilizing the latest advances in Ethernet technology, Dante offers simplified system configuration and extremely low latency while delivering very high quality uncompressed digital audio across the Lake network. The Zen™ automatic configuration feature enables plug-and-play setup without third-party DHCP or DNS servers. Dante is compatible with high-bandwidth networks, allowing large numbers of audio channels to be distributed alongside control and analyzer data. It also supports AES67, a new open standard, making it easier to connect and share audio between different products over standard IT networks.

2.3. Additional Documentation

This document, the PLM+ Operation Manual, serves as the primary reference source for detailed information on the installation and operation of PLM+ Series Powered Loudspeaker Management systems. It also provides detailed information on set-up and configuration using the front-panel interface.

For complete information on DSP configuration and operation using Lake Controller, please refer to the Lake Controller Manual, available online at www.labgruppen.com/support.

For detailed information on configuration and operation of the power platform using CAFÉ, please refer to the guide embedded in the software or to the CAFÉ Coach video series available on the Lab.gruppen YouTube channel or via a link on www.labgruppen.com.

3. Installation

3.1. Unpacking

Carefully open the shipping carton and check for any damage to the device or the supplied accessories. Every Lab.gruppen product is tested and inspected before leaving the factory and should arrive in perfect condition. If any damage is discovered, please notify the shipping company immediately. Only the consignee may initiate a claim with the carrier or their insurers for damage incurred during shipping. Save the carton and packing materials for the carrier's inspection.

In addition to the PLM+ Series device, the shipping carton includes the following items:

- PLM+ Series Quick Start & Field Reference Guide
- AC mains lead (power cable) with Neutrik® powerCON® connector
- Rear brackets for additional rack support (pair) along with associated mounting hardware

Please keep the original carton and associated packaging to facilitate shipping of the device should the need arise.

3.2. Mounting

Airflow for cooling the device is from front panel (intake) to rear panel (exit). Please ensure that no objects, such as rack doors or lids, are placed at the front or rear of the rack to ensure that airflow is maximized. This device has no top or bottom vents and therefore PLM+ units may be stacked directly on top of each other.

Sufficient space should be available at the front of the rack to accommodate the handles, and at the rear to accommodate connectors and cables; allowance must be made for cable or loom bends within a rack.

3.2.1. Rear Mounting

Two rear support brackets along with associated mounting hardware are included with the PLM+, as shown in Figure 3.1; it is recommended that these are used wherever possible. Fit the brackets to the vertical rails at the rear of the rack. Figure 3.2 and Figure 3.3 show the fitting options for fixed and removable installation.

The support brackets are reversible and may be fitted to point either to the front or rear of the rack; the orientation used depends on the rack depth and position of the rear rack rails.

Two mounting methods are possible; note that the method shown in Figure 3.2 additionally provides extra security against unauthorized removal. For situations where rapid removal and replacement is required, the method shown in Figure 3.3 should be used.

Fig 3.1: Rear support bracket with mounting hardware

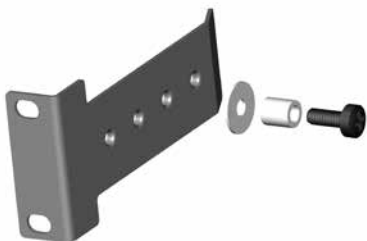

Fig 3.2: Rear support bracket mounted for fixed installation and bracket pointing forward

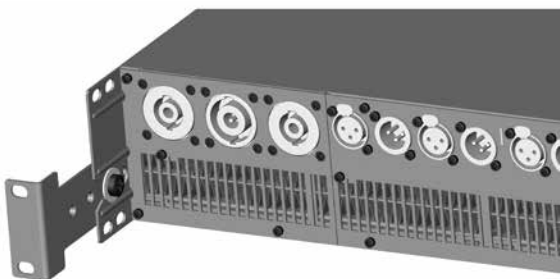



Fig 3.3: Rear support bracket mounted for removable installation and bracket pointing back



3.3. Cooling

3.3.1. Overview

The PLM+ Series devices use a forced-air cooling system with airflow from front to rear, allowing high continuous power levels without thermal problems. Front-to-rear airflow is preferable as air at the front of a rack is cooler than that at the rear in nearly all situations; never attempt to reverse the airflow. The operation of the PLM+'s cooling system is dependent on front-to-rear airflow; it will not function effectively with external airflow in the opposite direction.

 Make sure an adequate air supply is provided in front of the PLM+, and that the rear of the PLM+ has sufficient space to allow air to escape. If the PLM+ is rack-mounted, never operate the unit with any front or rear rack doors or covers in position. It is recommended to keep the ambient temperature around the PLM+ as cool as possible. An increased temperature can have a significant negative impact on the expected lifetime on the components inside the PLM+.



NOTE: Fit solid blanks (not ventilation blanks) to unused rack spaces to ensure effective air circulation. Leaving gaps in between items of equipment degrades the effectiveness of forced-air cooling.

 If installing one or more PLM+ Series devices in a rack with other fan-cooled equipment, be sure that all the other equipment also uses front-to-rear airflow for cooling. If this precaution is not observed, there is a risk of overheating, as units with the reverse airflow will be drawing in air which has already been heated by the PLM+s.

3.3.2. Temperature Sensing and Protection

The PLM+ is equipped with a sophisticated temperature sensing system which protects it from any overheating which may occur as a result of inadequate ventilation.



NOTE: Always ensure the dust filters behind the detachable front panel are clean to ensure maximum possible airflow.

3.4. Operating Voltage

 The label adjacent to the mains (AC) input connector indicates the AC mains voltage for which the device is wired and approved. All PLM+ models incorporate a universal power supply operating from 65 V to 265 V, but with UVL (Under Voltage Limiting) active below 80 V. Only connect the mains cable (AC cord) to an AC source of the voltage shown on the label.

The PLM+ uses primary switching, which means the mains power is rectified on the primary side of the transformer. This makes the power supply insensitive to mains frequency variation, and it will operate normally on line frequencies from 45 to 75 Hz.

If the mains plug (AC plug) fitted to the mains cable (AC cord) is not appropriate for your country, it can be removed and a locally-sourced one fitted instead, observing the color coding in the table below:

powerCON pin	230 V Cable	115 V Cable
L	Brown	Black
N	Blue	White
	Green/Yellow	Green

Table 3.1: AC Plug Configuration

 If you are not 100% confident of your competence to replace the mains plug (AC plug), the task should be carried out by qualified personnel.

Once a suitable AC power supply is connected, the device can be turned on using the front panel power button. When the device is turned on, the power button LED changes from red (Standby) to green (Active).



NOTE: In-rush current is controlled and limited during the soft-start sequence. This enables multiple PLM+ units on the same AC mains circuit to be turned on simultaneously

3.5. Grounding

Analog inputs feature Iso-Float™ ground isolation, a technology which combines the benefits of transformer coupled isolation with the advantages of clean, direct-coupled inputs.

The audio converters are galvanically isolated, and not connected to mains ground. High-speed transformers and opto-isolators create a barrier between the device and the outside electrical environment.



NOTE: The Iso-Float feature is activated by default, but may be disabled via the Lake Controller software, or via the front panel menu.

Use correctly-shielded balanced audio input connections to minimise hum and interference. Please refer to section 8.2.4 for further information.

 NEVER disconnect the earth (ground) pin on the mains cable (AC power cord).

4. Product Overview

4.1. Front Panel Overview

The front panel presents the following amplifier status indicators:



The front panel controls are clustered around a daylight readable LCD **3**, allowing adjustment and monitoring of the majority parameters and meters. The two clusters of controls on either side of the LCD include five dedicated function buttons **4 5 6 7 12**, eight dynamic function buttons with embedded LEDs **8 9** and a rotary data encoder **11**.

1 Handles – Two sturdy cast aluminium handles are integrated into the front panel. The handles should be used when carrying the device, and when fitting into or removing from a rack. Ensure that any door or removable rack front cover has sufficient depth to clear the handles.

2 Dust Filters – Two dust filters are fitted behind metal covers. To remove the covers, loosen the thumbscrews located behind the handles. Once detached, the dust filter elements can be removed for cleaning; please refer to section 9.2 for further information.



NOTE: NEVER operate this device without the dust filters in place.

3 Display – The display illuminates when the device is on, except when screen saver is active. The LCD, function buttons, and the rotary encoder provide real-time control and monitoring of most parameters. The LEDs embedded in the function buttons indicate available menu options, provide confirmation of Controller communication, and indicate various faults and warnings. The display automatically returns to Home view if no activity within two minutes.

The brightness and contrast of the display and front panel LEDs can be adjusted via the front panel menu. A screensaver will turn off the display when the unit is left without any action or with very low power output signal for 30 minutes. It will light up again at the push of any button, when the Lake Controller communicates with any frame or when signal reaches above -20 dB on any power output. Please refer to Section 7 for further details.

4 Standby – PLM+ Series devices are powered on and to standby using the top-left button, or via the Lake Controller.

⑤ **Mute Enable** – Select MUTE ENABLE to allow the dynamic function buttons to operate as mute controls for the Module inputs and power output channels. The MUTE ENABLE button flashes when the mode is selected; a subsequent press deselects this mode. If left activated, MUTE ENABLE mode will automatically disable two minutes after the last mute action.

⑥ **Meter** – The METER button scrolls through various meter views including the default Home View, Amplifier Meters View, Temperature Meters View, Input Meters View and Module Meters View. Pressing METER from Menu Mode returns the screen to Meter Mode with the Home View displayed. Please refer to section 7.5 for further details.

⑦ **Menu** – After pressing the MENU button, the LCD will display the top level menu. In Menu Mode the dynamic function buttons enable access to various information and functionality. Please refer to section 7.6 for further details.

⑧ **Dynamic Function Buttons with LEDs (Left of LCD)** – The function of these buttons change according to the currently selected view or menu.

- In Menu Mode they are used for menu navigation and for parameter selection
- In Meter Mode they provide Module input mute/unmute functionality in conjunction MUTE ENABLE

The left buttons provide Module input mute functionality, mute indication and faults and warning indications relating to the individual PLM+ inputs. All four LEDs will flash simultaneously when indicating frame faults (red) or warnings (yellow). Please refer to section 9 for further details.

⑨ **Dynamic Function Buttons with LEDs (Right of LCD)** – The function of these buttons change according to the currently selected view or menu.

- In Menu Mode they are used for menu navigation and for parameter selection
- In Meter Mode they provide PLM+ output mute/unmute functionality in conjunction MUTE ENABLE

All LEDs provide individual mute, clip, fault and warning indications for the PLM+ power outputs channels. Please refer to section 7 for further details.

⑩ **Communication LED** – The high-intensity white LED illuminates white to indicate that the Module/Frame is selected in the Lake Controller; it flashes white to indicate communication with the Lake Controller.

The brightness of the LCD and communications LED can be adjusted in the Frame page of the Main Menu on the front panel.

⑪ **Rotary Encoder** – The rotary encoder is used to modify various parameters (e.g. input level) via the menu. When a menu item is selected that permits adjustment of parameter values, the ring around the rotary encoder illuminates. In Home View the encoder can be used to scroll through the Meter Views.

⑫ **Exit** – The EXIT button is used primarily while navigating the menu system in Menu Mode; pressing EXIT will return the menu up one level. In Meter Mode, pressing EXIT returns the metering display to the default Home View.

4.2. Rear panel

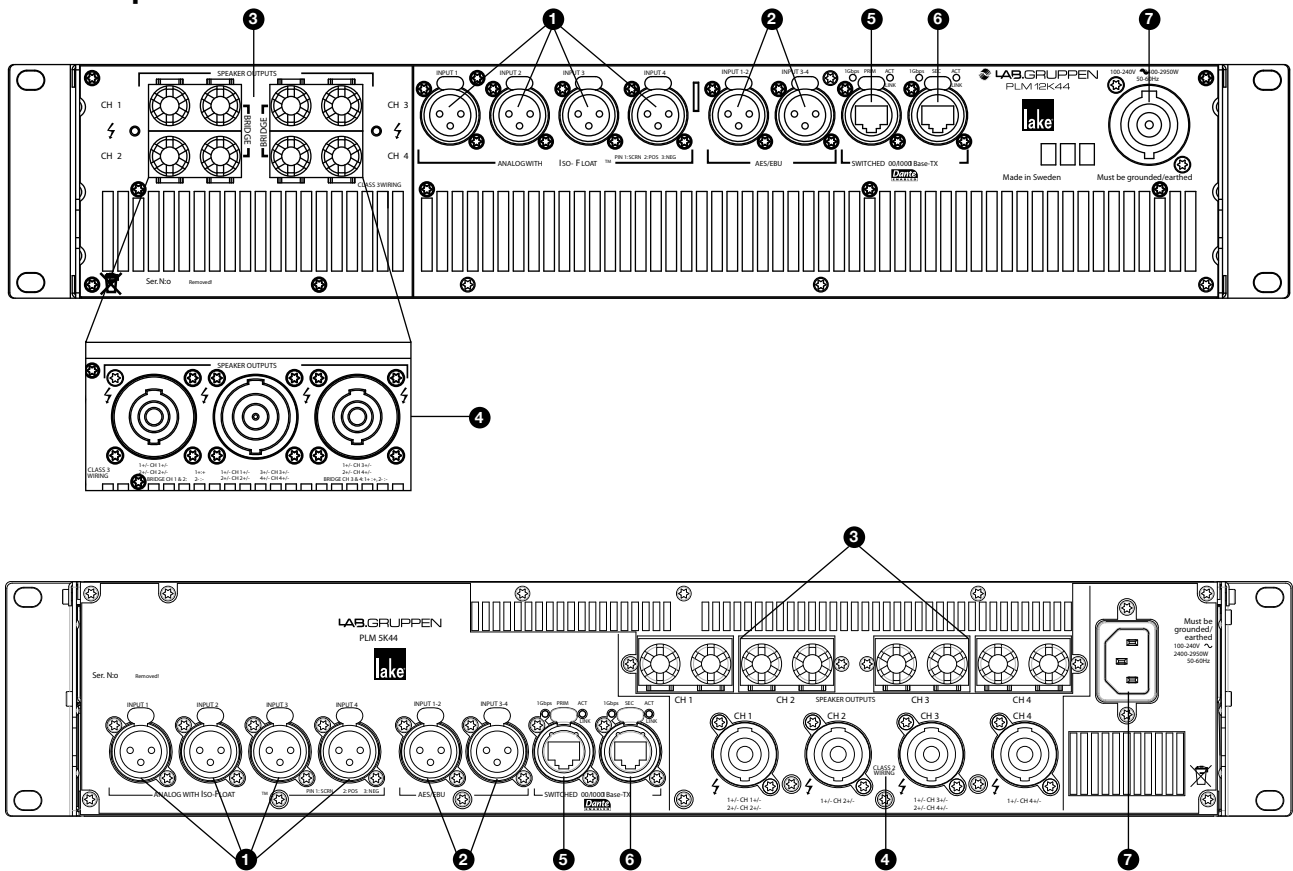

Input Connectors

- ❶ **Analog Inputs** – Four analog inputs are available on standard XLR-3F connectors, electronically balanced and featuring Lake Iso-Float circuitry. Impedance is 20 kohms; maximum input level is +26 dBu.
- ❷ **AES3 Inputs** – Two latching XLR-3F connectors accept four channels of AES3 digital audio. Input impedance is 110 ohms; ensure that 110 ohm digital audio cables are used.

Output Connectors

The PLM20K44 and PLM12K44 are Your device will be equipped with one of the two output connector options. Both options allow for Bridge Mode operation, which is activated in the Lake Controller software. Please refer to the Lake Controller Operation Manual for more information. The PLM5K44 is equipped with both binding posts and speakON connectors, and does not support Bridge Mode operation.

- ❸ **Binding Posts** – Power outputs are available on four separate pairs of fully enclosed binding posts.
- ❹ **speakON connectors** – Power outputs are available simultaneously on a single 8-pole connector (PLM20K44 and PLM12K44 only) and on two 4-pole connectors. The four-pole connectors carry outputs for channels 1&2 and 3&4 respectively. For PLM5K44, connector 1 carries output channels 1 and 2, connector 2 carries channel 2, connector 3 carries channel 3 and 4, and connector 4 carries channel 4.

Ethernet and Power Connectors

⑤ **Primary Network Connector** – The primary Neutrik RJ45 etherCON® connection provides integration into an Ethernet control network which may include other Lake Processors and the Lake Controller software. Network connection permits full control of all functions along with real-time metering from a remote position. This device supports the Dante audio networking protocol for multichannel, high-definition digital audio over the same Ethernet connection. It also supports AES67 audio flows.

Use the primary connector when using a star network topology, consisting of individual Cat-5e connections between the devices and an Ethernet switch. Alternatively, this connection can be used to daisy chain directly to another Lake Processor. The daisy chain topology should not be used with Dante.



Note: Do not create a closed loop when configuring multiple devices in an Ethernet network; this will cause a network malfunction.

⑥ **Secondary Network Connector** – The secondary network connector can be used to daisy-chain multiple PLM+ Series devices. Alternatively, a Dante dual-network topology can be created by connecting all secondary network connectors to a separate Ethernet switch, ensuring full redundancy in the event of a network component failure. If the device has Dual Redundancy enabled, any AES67 audio must be on the Primary network (i.e. AES67 cannot be transmitted or received on the Secondary connector).

⑦ **Mains Power Connector** – AC mains input for the PLM20K44 and PLM12K44 is via a Neutrik powerCON connector, rated at 32A. Connector mates with supplied AC mains cable. PLM5K44 uses a standard IEC locking connector. See previous section on Operating Voltage for more information.

5. Operation and performance

5.1. Operation precautions

Make sure that the Standby button on the unit's front panel is either unlit (OFF), or red (STANDBY), before making any input or output connections. Ensure the AC voltage is within the range printed on the label adjacent to the AC mains connector. Ensure no input signal is present when powering on the unit to reduce the risk of any inadvertent bursts of high level audio.

5.2. Power output performance

The PLM20K44 and PLM12K44 use Lab.gruppen's patented Class TD technology (Tracking Class D) in the output stages, which couples the efficiency of Class D topologies to the sonic purity of Class A/B designs. The primary benefit is that Lab.gruppen's Class TD works perfectly under all load conditions. The output maintains its flat frequency response even into complex loads with very low nominal impedances. Reliability is very high, and there is no interference with nearby RF equipment. Superior efficiency allows greater power density while minimizing cooling requirements, yet sound quality matches that of the best Class A/B designs. The PLM5K44 uses a newly developed Class D technology design with increased efficiency and sustained sonic performance.

5.2.1. Symmetrical Power

The PLM+ models can deliver power as shown in Table 5.1 when all channels are driven equally.

Load Impedance (ohms)	2 ohms (per channel)	2.67 ohms (per channel)	4 ohms (per channel)	8 ohms (per channel)	16 ohms (per channel)
PLM 5K44	900 W	1250 W	1250 W	1250 W	700 W
PLM 12K44	3000 W	3000 W	3000 W	1900 W	950 W
PLM 20K44	4400 W	5000 W	4400 W	2300 W	1150 W

Table 5.1: Symmetrical Load Power Ratings

5.2.2. Rational Power Management™

Rational Power Management™ (RPM) is a unique Lab.gruppen feature that allows for flexible allocation of power across channels of the PLM+ unit. Power that is not used by one output channel is free for use by another output channel with greater demands. Unique to this range is also that the smaller models in the range have amplifier channels that can produce the maximum channel power of the largest model. Hence, by using RPM, it is possible to significantly scale up a channel from its average, which is 25% of the total available power in the frame. RPM allocates power up to the total limits of the specific amplifier model.

Desired power can be specified in several domains: burst and peak power; peak and RMS voltage; and also the speaker's AES power rating. By specifying the nominal impedance of the load, the RPM algorithms have all input data required to calculate resulting RPM settings. If the desired RPM settings taken together allow total output higher than the capabilities of the amplifier, RPM will reduce actual RPM configuration evenly based on a proportional reduction in dB. Once applied, the RPM functionality will ensure that the channel is not delivering more power than specified. The ISVPL limiter algorithm performs the actual limitation. As default, the smaller models in the range have an RPM configuration detailing an equal shared power allocation cross the channels at a voltage (default voltage limitation) given in the specification sheet. To prevent the risk of over allocating the power supply for varying or incorrect load impedances, RPM has a limitation for the smaller models in the range of the number of channels that can be lifted above the default voltage limitation. RPM can be configured in two modes.

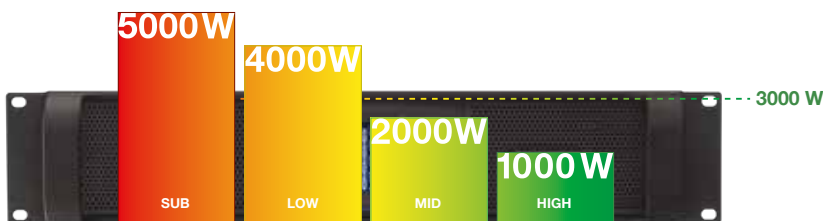

Figure 5.2: Amp channels power adjusted to match the loudspeaker requirements

Auto RPM: The frame will automatically allocate power per output channel according to the ISVPL settings in the speaker preset (per module output) in Lake Controller. Auto RPM assumes a nominal impedance of the Load and applies an approximate power allocation. Auto RPM is default for PLM+.



Custom RPM: The CAFÉ software allows users to create an advanced custom power allocation scheme. Switching to Custom mode disables the Automatic mode. Additional information is available in documentation supplied with the CAFÉ software download.

CAFÉ with ESP: CAFÉ (Configuring Amplifiers For the Environment) is a dedicated software application for Windows and OSX that provides tools for system planning, specification and commissioning. CAFÉ incorporates the Equipment Specification Predictor (ESP), a software module that examines SPL and speaker requirements for a project and generates requirements for output power on an amplifier and system level. ESP will generate a custom RPM configuration optimizing the power allocation within the frame. For more information on CAFÉ and ESP, please consult the documentation supplied with the CAFÉ software download.

5.3. Amplifier and Load Protection Systems

The PLM+ is equipped with a comprehensive set of protection circuits. If operating conditions become sufficiently extreme that any of these circuits become active, indication is provided by amber or red LEDs on the front panel, and by text notifications in the Lake Controller and CAFÉ software. Refer to section 9.1 for more information on warnings and faults.

5.3.1. Inter-Sample Voltage Peak Limiter (ISVPL)

The ISVPL is a high quality voltage limiter that can deliver seamless signal limiting to any desired level. It ensures that the voltage at the output terminals never exceeds the defined threshold. It operates on these principles:

- The signal is delayed slightly to allow the ISVPL to look-ahead and reduce the gain before voltage in excess of the threshold can appear at the output. This results in zero voltage overshoot at the output with a rounded limitation up to the threshold.
- The amplitude of the output signal between digital samples is predicted which permits the ISVPL to respond to analog peaks that may occur at the digital to analog converter.
- The release time of gain reduction is adaptive depending on the dynamics of the signal. It is possible to select different ISVPL profiles for limiting optimization for a specific frequency band and personal preference. The profiles are divided into two categories, with one category optimized for low distortion and the other focusing on producing high sound pressure level (SPL). Within each category there are profiles optimized for the different frequency bands.

5.3.1.1. Low Distortion Profiles

- Universal – The universal profile is a soft limiter that can be used for all frequencies and is conservative in its action upon VCL and CPL.
- Sub/LF – The Sub/LF profile is tuned for frequency bands below 600 Hz. It has longer attack and release times and is less conservative when it comes to acting upon VCL and CPL.

5.3.1.2. High SPL Profiles

High SPL profiles do not use the adaptive release time feature. High SPL profiles optimized for high frequencies use less of the look-ahead delay peak-rounding feature; this feature is used most in the Sub profile and least the HF profile.

- Sub – The Sub profile is optimized for frequencies between 20 – 200 Hz
- LF – The LF profile is optimized for frequencies between 20 – 1200 Hz
- MF – The MF profile is optimized for frequencies between 300 – 6000 Hz
- HF – The HF profile is optimized for frequencies above 1 kHz

Table 5.3 shows the theoretical maximum output power for a given load impedance and ISVPL setting.

Max. Sinewave Burst Power (Watts)					
Load Impedance (ohms)	2	2.67	4	8	16
ISVPL SETTING (V peak)					
194	4489	5993	4705	2352	1176
193	4489	5993	4656	2328	1164
181	4489	5993	4095	2048	1024
167	4489	5223	3486	1743	872
153	4489	4384	2926	1463	732
121	3660	2742	1830	915	458
101	2550	1910	1275	638	319
83	1722	1290	861	431	215
70	1225	918	613	306	153
56	784	587	392	196	98
47	552	414	276	138	69
38	361	270	181	90	45
17.8	79	59	40	20	10

Table 5.3: ISVPL-to-output examples

The ISVPL threshold may be set at any level between 17.8 V and 600 V in the Lake Controller software. For further details, please refer to the Lake Controller User Manual.

Lake-enabled amplifier devices (D Series Lake, PLM+, PLM) that have a smaller peak output voltage capability still allow ISVPL speaker threshold settings up to 600 V. When a threshold is set above the current maximum capability of a power output channel, the actual ISVPL will automatically be set to the maximum ISVPL for that channel. channel and displayed in []. Therefore, the ISVPL threshold can be set at the Module for the speakers's maximum capability, and the Module file remains cross-compatible with all Lake-enabled amplifier devices.

5.3.2. Current Peak Limiter (CPL)

The output Current Peak Limiter (CPL) ensures that the power output section will not be damaged by forcing it to deliver current levels at the outputs that exceed the maximum current ratings of the output transistors. The CPL keeps the output transistors within their Safe Operating Area (SOA). The CPL is non-adjustable.

This condition indicates an attempt to draw excessive current at the output. The output is attenuated until the output current falls below the maximum current rating. Limiting is performed by the ISVPL limiter in conjunction with the selected ISVPL profile.

CPL activity is shown by red indication on the Power channel LED of the affected output channel and a corresponding text description on the front panel in Lake Controller and CAFÉ software programs. Refer to section 9.1 for more information on warnings and faults.



NOTE: If excessive current is indicated, check the output cables and examine the loudspeaker. If impedance appears normal, you may rectify the condition by altering the ISVPL settings or lowering input levels. CPL indication can be triggered by excessively low output impedance, possibly the result of too many loudspeaker cabinets connected in parallel.

5.3.3. Power Average Limiter (PAL)

The Power Average Limiter Active warning (PAL Active) will be displayed when the power supply's maximum rated design parameters are reached. When this warning is displayed, gain limiting is being applied to the output signal and the ISVPL threshold is lowered accordingly.

PAL activity is shown by flashing yellow on the frame LEDs and a corresponding text description on the front and in Lake Controller and CAFÉ software programs. Refer to section 9.1 for more information on warnings and faults.

5.3.4. Breaker Emulation Limiter (BEL™)

PLM+ amplifiers are powerful devices that can draw a considerable amount of current from the mains supply. The BEL models the temperature in the external breaker and limits the mains current to prevent the breaker from tripping. The BEL can be configured with both a breaker profile and a nominal current value. The nominal current value can be set from 1 to 32 Arms, though the PLM 12K44 will automatically limit at between 5-25 and the PLM 5K44 between 2-15 Arms. Just as with ISVPL, the actual value is displayed in []. The different models have different maximum current capabilities as specifies in the specification sheet. Also, the smaller models can be configured all the way up to maximum user range. When the nominal current is set above the model's capabilities, the actual current is set to the maximum capabilities of the unit. Therefore, the nominal current can be set for the application and the configuration remains cross-compatible with all the models. There are three different profiles available for selection:

- Conservative – The conservative profile allows no momentary current above the configured threshold.
- Fast – The fast profile models the time constant of the trip–curve corresponding to a fast breaker. It momentarily allows current above the threshold to pass for a short time, leading to an increased modeled temperature. For the limiter to disengage, the current must reduce below the threshold to enable the breaker to cool down.
- Universal – The universal profile models the time constant of the trip–curve corresponding to a slow breaker. It momentarily allows current above the threshold for a longer time, leading to an increased modeled temperature. For the limiter to disengage, the current has to reduce below the configured current for the breaker to cool down.

The BEL is configured manually from the front panel with the Lake Controller or CAFÉ software. CAFÉ's ESP design aid can also predict the current consumption, with the exact speaker requirements, and propose a safeguarding BEL configuration

BEL activity is shown by flashing yellow on the frame LEDs and a corresponding text description on the front panel, in Lake Controller and CAFÉ software programs. Refer to section 9.1 for more information on warnings and faults.

5.3.5. Under Voltage Limiter (UVL™)

PLM+ devices are equipped with an under voltage limiter. With multiple, powerful devices on a mains distribution line, heavy current loads risk the reduction of voltage below that required for devices to function. The UVL reduces the mains current draw when voltage drops below 80 V. The amount of reduction applied increases as mains voltage drops towards 65 V; at 65 V the power supply is shut down. The mains supply is continually monitored and when sufficient voltage returns the power supply automatically restarts.

UVL activity is shown by flashing yellow on the frame LEDs and a corresponding text description on the front panel, in Lake Controller and CAFÉ software programs. Refer to section 9.1 for more information on warnings and faults.

5.3.6. Current Average Limiter (CAL™)

The Current Average Limiter (CAL) monitors the RMS current drawn from each power output channel to ensure that the power output stages are not overloaded. When activated, it regulates the current to a safe level to protect the channel. The CAL should not be activated in normal usage. CAL activity is shown by red indication on the affected Power channel and a corresponding text description on the front panel, in Lake Controller and CAFÉ software programs. Refer to section 9.1 for more information on warnings and faults.

5.3.6.1. PLM5K44

For the PLM5K44, the CAL threshold is calculated per Power channel based on the actual ISVPL setting. A high ISVPL setting results in a lower average current, whereas a lower ISVPL setting allows for a higher average current.



NOTE: For **PLM5K44**, to optimize the CAL's behavior when playing into a low impedance load - manually set the desired ISVPL to reflect the real peak Voltage output to allow for a higher average current.

5.3.7. Voltage Clip Limiter (VCL)

If current draw from the unit's power supply is too high, the PSU's regulation capability may be exceeded and the internal voltage rails may drop and cause clipping. If this occurs, the VCL acts rapidly to prevent clipping on the subsequent peaks. Limiting is performed by the ISVPL limiter in conjunction with the selected ISVPL profile. Voltage Clip is shown by red indication on the affected Power channel and a corresponding text description on the front panel, in Lake Controller and CAFÉ software programs. Refer to section 9.1 for more information on warnings and faults.

5.3.8. Temperature Protection

5.3.8.1. Overview

PLM+ devices are equipped with a sophisticated temperature sensing system that provides protection from overheating which may occur as a result of inadequate ventilation or excessive power output. Thermal measurements are made at several points within each power output channel along with measurements in the power supply and DSP areas. The temperature protection scheme is designed to let the amplifier to operate continuously, with the highest possible output, and prevent shutting down. If temperature in any area reaches a critical level, a warning is displayed. The warning is issued at approximately 80% of the maximum allowable temperature. If the temperature continues to increase, a limiter is engaged that limits signal peaks to reduce further heat accumulation. Limiting is accomplished by gradual reduction of the ISVPL thresholds. In the extreme case where the limiter cannot reduce heat accumulation and temperature reaches a dangerous level, a fault is displayed and audio is muted.

Each power output channel, the power supply, and DSP area have separate indications. For all temperature faults, temperature monitoring will continue at 0.5 second intervals, with the output remaining muted. When the area has cooled below the dangerous threshold, the fault condition is cleared and audio is restored.

5.3.8.2. Power Output Channels

A Power output channel temperature warning or fault is shown by yellow or red indication on the affected Power channel and a corresponding text description on the front panel, in Lake Controller and CAFÉ software programs. Refer to section 9.1 for more information on warnings and faults.

5. Operation and performance

When an amplifier output channel reaches the temperature warning threshold, the Amp channel Temperature Limiter (ATL) is engaged, reducing power output to avoid amp channel protection (muting). Limiting is removed when temperature falls below the warning threshold.

5.3.8.3. Power Supply / DSP

A power supply (PSU) or DSP temperature warning or fault is indicated by flashing Frame LEDs.

- A warning is indicated by flashing yellow LEDs
- Power supply Temperature Limit (PTL) is indicated by flashing yellow LED
- A fault is indicated with flashing red LEDs

When the power supply reaches the temperature warning threshold, the Power supply Temperature Limiter (PTL) is engaged. Total amplifier output power is reduced to avoid power supply fault protection (muting of all channels). Limiting is removed when the temperature falls below the warning threshold.

5.3.9. DC Protection

DC protection is implemented on each power output to prevent damage to connected loudspeakers or any PLM+ components. DC present at the output will cause the unit's power output module breaker to blow, causing a permanent hardware fault that prevents signal throughput. In this instance the channel's LED will illuminate red and a service channel fault will be visible on the display and registered in the Lake Controller and CAFÉ status views on the PLM 12K44 and PLM 20K44. For the PLM 5K44, there is no fault displayed in this instance, but no signal will be present on the output. For all models, the device will need to be sent in for service.



NOTE: A blown breaker in the power output module is not a user serviceable fault condition and the unit should be returned for repair.

5.3.10. VHF Protection

The PLM+ includes protection circuits that detect Very High Frequency (VHF) content in the output signal. The detection is amplitude-, frequency- and time-dependent. If continuous VHF signals are detected above the threshold for more than the attack time, the output will (for 20K44 and 12K44 only) attenuate the signal until it is below the VHF threshold. When this is done, a VHF Warning is displayed. If the signal is above the VHF threshold and the maximum of -12 dB of gain reduction is not enough to take the signal below the VHF threshold, the signal will go into mute after 15 seconds and a VHF Fault is displayed. VHF Fault will release the mute again after approximately 6 seconds. For a 5K44, the VHF threshold will directly go to VHF Fault and mute the signal for approximately 6 seconds before release and test again. When continuous VHF signal stops, the amplifier returns to normal operation.

This protection system recognizes only continuous VHF signals at high levels that will not appear in speech or music. Any such content can therefore be considered as a fault condition. VHF protection is essential to avoid damage to HF drivers. VHF protection is dependent on a combination of output power level and frequency. Figure 11.4 shows a decreasing power threshold, from approximately 10 kHz upwards, which illustrates increasing sensitivity of the protection system with frequency. When continuous output power above the threshold line is detected, VHF protection becomes active.

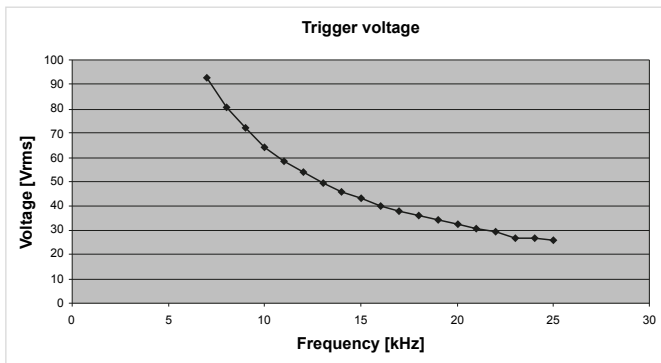

Fig 5.4: VHF Protection Frequency Sensitivity

The attack time of the VHF protection circuitry also changes with frequency, becoming shorter at higher frequencies. This is shown in Figure 5.5.

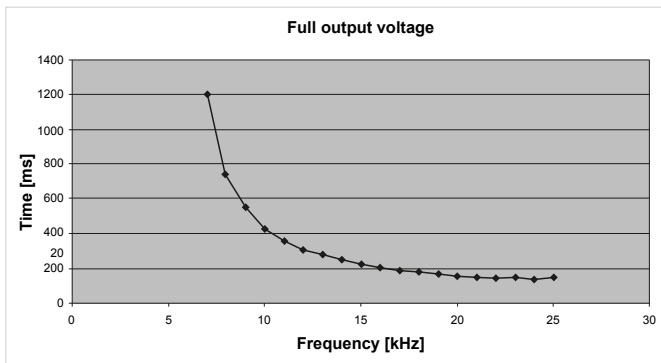

Fig 5.5: VHF Protection Attack Time Variations

The VHF protection circuit does not alter the amplifier's frequency response. It is implemented solely to detect continuous VHF content. HF content of normal music or speech signals at peak levels will be passed in full. Operation of the VHF protection circuits is indicated by the Power channel's LED that will illuminate yellow and display VHF Warning when the maximum -12 dB gain reduction is applied (20K44 and 12K44 only). The Power channel LED will light red for VHF Fault. Both of these will be registered in the Lake Controller and CAFÉ status views.

5.3.11. Short Circuit Protection

A low impedance or short circuit at the power output terminals is detected when the output current is high (Current Peak Limiter is active) and, simultaneously, the peak output voltage is below a predetermined threshold. When this situation occurs, the output stage is muted to protect it from damage.

Operation of the short circuit protection system is indicated by red indication on the affected Power channel and a corresponding text description on the front panel, in Lake Controller and CAFÉ software programs. Refer to section 9.1 for more information on warnings and faults.

The presence of a short circuit (or low impedance) is re-tested every six seconds, and the output remains muted until the fault clears.

5.3.12. Power supply protection

The power supply is very advanced and has several internal control and monitoring functions. Should any of these fail, the power supply will shut down to prevent damage or limit severity of the failure. Power supply faults, or power supply needs service faults, are indicated by flashing red on the frame LEDs and a corresponding text description on the front panel, in Lake Controller and CAFÉ software programs. Refer to section 9.1 for more information on warnings and faults.

In the extreme event of simultaneous low mains voltage supply and high power demand, the amount of incoming energy may not be sufficient for continued operation. The power supply will then be forced to shut down. This condition is a power protect fault, indicated with a red LED and associated error messages registered in Lake Controller and CAFÉ software programs.

5.3.13. Mains anomaly protection

PLM+ Series amplifiers incorporate several features to ensure continuous operation in case of irregularities in the AC mains service.

Over-voltage – If the power supply detects mains voltage above 400 V peak or 270 V RMS, it will enter protective shut down mode. The amplifier will auto-restart if the condition clears. Will be indicated by flashing red on the frame LEDs and a corresponding text description on the front panel, in Lake Controller and CAFÉ software programs. Refer to section 9.1 for more information on warnings and faults.

Under-voltage – If the power supply detects mains voltage of less than 65 V, it will enter protective shut down mode. The amplifier will auto-restart if the condition clears. Will be indicated by flashing red on the frame LEDs and a corresponding text description on the front panel, in Lake Controller and CAFÉ software programs. Refer to section 9.1 for more information on warnings and faults.

Mains instability – If the power supply detects protracted instability in the AC mains, it will enter protective shut down mode. The amplifier will auto-restart if the condition clears. Will be indicated by flashing red on the frame LEDs and a corresponding text description on the front panel, in Lake Controller and CAFÉ software programs. Refer to section 9.1 for more information on warnings and faults.

Mains glitch – If the power supply detects a momentary mains glitch (missing cycles) at the AC inlet, a warning indication will be reported with flashing yellow on the frame LEDs and a corresponding text description on the front panel, in Lake Controller and CAFÉ software programs. The power supply and product continue operation throughout a mains glitch.

Power protect – In the extreme event of simultaneous low mains voltage supply and high power demand, the amount of incoming energy may not be sufficient for continued operation. The power supply will then be forced to shut down. This condition is a power protect fault, indicated with flashing red on the frame LEDs and a corresponding text description on the front panel, in Lake Controller and CAFÉ software programs. Refer to section 9.1 for more information on warnings and faults.

5.4. Power Supply

The R.SMPS (Regulated Switch Mode Power Supply) is designed to keep supply voltage rails at optimum levels. Thus the R.SMPS can deliver full rail voltage to the output stage at all times, allowing the amplifier to exhibit consistent transient response and a clean LF response.

The PLM+ features a universal power supply with power factor correction (PFC). The device can accept any mains voltage, from 65 V to 265 V, allowing it to function worldwide in many different configurations. The PFC reduces current peaks on the lines and reduces the requirements placed on the mains distribution system. PLM+ units offer an unparalleled power factor extremely close to one.

5.4.1. Low Inrush Current

High power amplifiers with inadequate inrush current limiting can draw considerable current from the mains at turn-on, sometimes tripping a fast-acting mains breaker. The PLM+, however, has very low inrush current to prevent tripping of breakers. Several units can, under normal conditions, be powered up simultaneously. If you do experience problems powering up multiple units simultaneously, they must either be turned on manually in an ordered manner, or sequenced remotely using the Lake Controller software's Global Control feature. Alternatively, the capacity of the mains supply should be increased.



NOTE: If insufficient power is available to allow simultaneous power-up, then there is probably insufficient capacity for full power output during operation. It is recommended that additional capacity is added to the mains power distribution system.

5.5. LoadPilot Load Monitoring

5.5.1. Introduction

LoadPilot is a feature in PLM+ amplifiers that can continually monitor the integrity of loudspeakers and cables connected to the outputs to ensure that they are functioning properly and free from major anomalies or faults. By implementing LoadPilot, systems incorporating PLM+ amplifiers can be certified in compliance with voice evacuation standards such as EN54-16 and NFPA72.

LoadPilot functions by automatically superimposing low-level pilot tones on the input signal (if any present) to the amplifier. One tone is below the range of human hearing (approximately 10–20 Hz) and the other above (24 kHz), so the activity of LoadPilot is inaudible regardless of whether the system is currently reproducing program content. High-resolution current sensing on the outputs can calculate the impedance of the load at the frequency of the tones. Hence a stable measurement of the impedance of the load can be obtained and potential anomalies or faults can be detected that would indicate impaired loudspeaker function or total inoperability due to failure of the loudspeaker or faults in connected wiring. The superimposition of pilot tones and analysis is interleaved across the amplifier's output channels with a maximum total cycle time of around 20 seconds.

LoadPilot is implemented and configured in the CAFÉ software. Monitoring status and fault indication are displayed on the front panel and both in CAFÉ and Lake Controller.

LoadPilot may be configured with the automatic calibration or through a manual advanced mode, depending on monitoring requirements and characteristics of the connected loudspeaker loads.

5.5.2. Automatic calibration

5.5.2.1 Functional description

Automatic calibration is suitable for the following applications and requirements for error detection:

- If one or two low-impedance loudspeakers are connected; if two in parallel is default, it will warn if one is missing.

5. Operation and performance

- If there are one or two “spurs” with 70V loudspeakers connected; if two in parallel is default, it will warn if one is missing.
- If there is a short circuit in the load.
- If there is an open circuit (all loudspeakers missing).
- For passive 2– and 3–way loudspeakers, if one or two LF drivers are connected and working; if two in parallel is default, it will warn if one is missing.
- For some passive 2–way designs, if one HF driver is disconnected. (However, with some loudspeakers the HF impedance is dominated by a passive component i.e. crossover filter and the anomaly will not be detected.)



NOTE: LoadPilot is enabled only when the amplifier is On. It does not function while the amplifier is in Standby.

5.5.3. Manual configuration

5.5.3.1. Functional description

Manual configuration can be used in special cases where proper functioning requires setting of custom measurement frequencies, custom measurement levels, custom warning thresholds, or combinations of the three. Manual configuration addresses the following issues:

High noise levels – To obtain accurate impedance measurements, it is necessary to drive a current sufficiently above the noise floor. However, it is important to keep the level low in order to prevent audible artifacts from cone travel. At very high impedances, the drive current may be insufficient. In the automatic mode, level is set around 60 mV which produces usable results for impedance up to 660 ohms.

Inductance in loudspeaker cables – Loudspeaker cable inductance at higher frequencies is very high relative to passive resistance, and the inductance increases linearly with length. Consequently, monitoring at the 24 kHz pilot tone frequency can be problematic with very long cables. The automatic mode will estimate cable impedance for 24 kHz and allow it to be used as long as it is less than 33% of total impedance presented by the load and as long as the total impedance is below about 440 ohms.

DC blocking capacitors in loudspeakers – Some loudspeakers incorporate a capacitor designed to block damaging voltages at very low frequencies. This may inhibit accurate measurements when using the 10 Hz pilot tone. In automatic mode, LoadPilot will disable the 10 Hz tone if total impedance is above about 440 ohms.

Constant voltage loudspeakers – Loudspeakers driven via transformers in 70V/100V solutions are more likely to exhibit wide variations in measured impedance as music and/or pilot tones are reproduced by the system. Also, most constant voltage systems operate more than two loudspeakers in parallel. Therefore, in addition to manual configuration of LoadPilot, additional step may be required. These include:

- Insertion of a series capacitor in each loudspeaker to block the 10 Hz LF tone – This will defeat measuring the loudspeakers with the LF tone, but will allow the LF tone to propagate through the entire cable run.
- Insertion of EOL (end-of-line) resistors – This enables LoadPilot to detect cable faults in a spur of the system.
- Insertion of EOL (end-of-line) inductor – This is not mandatory, but it will avoid the loss of level at mid and high frequencies due to the EOL resistor.



NOTE: Manual configuration of LoadPilot is implemented in CAFÉ versions 1.1.0. and later. For detailed information on manual configuration of LoadPilot, please refer to the integrated guide in the software program and to the CAFÉ Coach videos posted on the Lab.gruppen web site and on the Lab.gruppen channel on YouTube.

5.5.4. Indication

The LoadPilot feature constantly monitors the impedances at the two given pilot tone frequencies and compares to the measured thresholds. The following faults and warnings can be triggered.

- Speaker shorted warning – Both tones below lower threshold. Corresponds to a distant short circuit that can either be in the cabling or in the speaker.
- Speaker damaged warning – One of the tones is below or above thresholds. Corresponds to an unexpected impedance deviation of one of the tones, most likely a damage to the speaker.
- Under speaker count warning – Both tones above upper threshold. Corresponds to an impedance increase across the impedance response and most likely a loss of speaker(s) in a parallel speaker connection.
- No load fault – At least one tone above measurable area or significantly above upper threshold. Most likely corresponding to loss of the load.
- Short circuit fault – LoadPilot analysis below short circuit threshold.

5.6. Audio over Ethernet

The PLM+ Series Lake devices include Dante and AES67 digital audio networking as standard, utilizing the latest advances in Ethernet technology. Dante offers simplified system configuration and extremely low latency while delivering very high quality uncompressed digital audio across the Lake network. The Zen™ automatic configuration feature enables plug-and-play setup without third-party DHCP or DNS servers. Dante is compatible with high-bandwidth networks, allowing large numbers of audio channels to be distributed alongside control and analyzer data.

AES67 is a new open standard making it possible connect more devices together and share audio.

The PLM+ also have a feature to convert between AES67 and Dante, and can accordingly work as a bridge between the two different network protocols. It can input 8 channels of AES67 and transmit them out again as 8 Dante channels or vice versa and in any combination of Dante and AES67 channels.

The PLM+ support 8x8 inputs and outputs on Dante/AES67. The networked audio channels' inputs are routed to the Dante receivers and are shared between both Dante and AES67. Therefore, the total number of networked audio inputs can be 8 (Dante + AES67).

On the output side, the device has 8 channels in total – and it is possible to configure the channel as Dante only (Unicast or Multicast) or as an AES67 flow as well. Up to 8 channels can be included in a AES67 transmit flow.

In order for the device to be able to input networked audio, “Dante” must be enabled in Lake Controller. See Lake Controller Operation Manual for further details.

5.6.1. Dante

The PLM+ support dual redundant inputs and outputs on Dante, in either 48 or 96 kHz, with receive latency as low as 0.25 ms and up to 5 ms.

Dante devices and channels can be given “friendly” names, meaning audio can be routed without having to use or remember complex numbers.

Dante channels can be routed in Dante Controller or in Lake Controller.

5.6.2. AES67

When the device is in AES67 enable mode, the device is in 48 kHz only (also for Dante subscriptions/transmissions). The receiver latency for AES67 subscriptions are 2 ms. Transmission flows are Multicast only.

AES67 subscriptions can only be configured in Dante Controller. The AES67 transmitter must support the SAP (Session Announcement Protocol). This is one of four device discovery methods referenced in the AES67 standard. Check if the transmitting non-Dante AES67 device supports SAP. Otherwise Dante Controller cannot discover the audio flows coming from the device. Dante devices support SAP if their AES67 mode is enabled.

Multicast IP addresses must be in the range of 239.69.0.0 - 239.69.255.255.

If dual redundancy is enabled on the device, the AES67 flow only works on the primary network. It is still possible to utilize Dante on primary and secondary networks at the same time as a AES67 flow is present on the primary.

6. Signal Flow and Lake® Processing

6.1. Signal Flow

The figures below depict the audio signal flow for a PLM+ Series device. It is worth noting that this sophisticated device provides seven points in the signal chain where the signal level can be adjusted, muted or disconnected. The blue sections represent Frame data, and the red sections represent Module data - please refer to the Lake Controller Operation Manual for further information.

Important information regarding correct setting of the gain structure can be found in section 10.2.

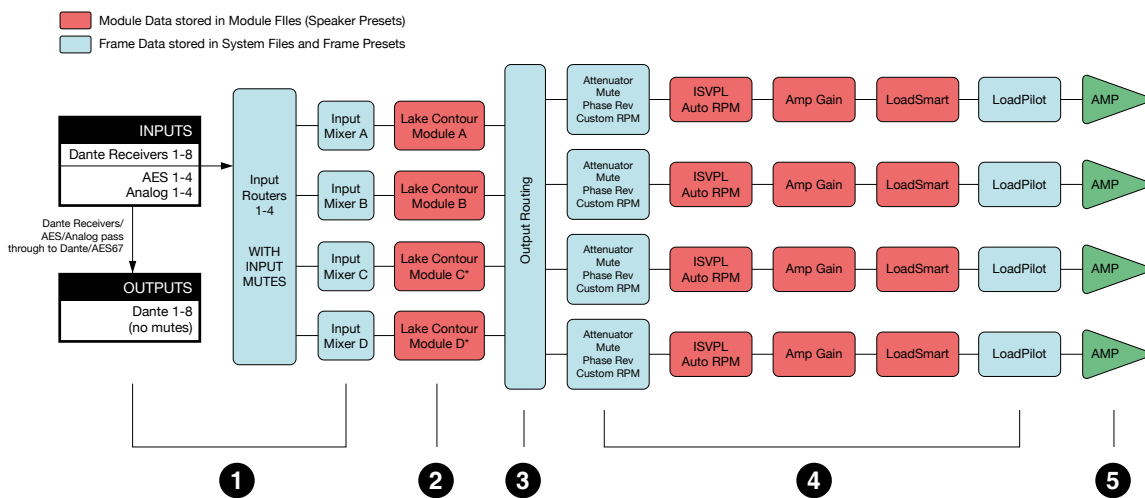

Figure 6.1: PLM+ Signal Flow Diagram

- ❶ The input section (inputs, input router and input mixer) allows for mixing capabilities as well as redundant and prioritized inputs with automatic switch-over in case of signal failure.
- ❷ Up to four Lake Processing modules provide user EQ and loudspeaker processing, including LimiterMax limiting.
- ❸ The Output router allows free routing between module outputs and power output channels.
- ❹ Each power output channel provides individual channel processing, including ISVPL limiter, RPM and load monitoring.
- ❺ Power Amplifier

6.2. Level Adjustments & Mute Points

- 1 Input Router Stage** Input selection and MUTE
- 2 Input Mixer Stage** Router on /off connection to mixer and gain settings
- 3 Module Input Stage** Mute (N/A for LM Series Mesa Mode) and gain settings
- 4 Module Output Stage** Mute and gain settings
- 5 Output Router Stage** Output on /off routing connections
- 6 Attenuation Stage** Power output channel mute and attenuation settings
- 7 Amp Gain Stage** Amplifier gain control



NOTE: If the required audio signal is not passing correctly, verify the connection, mute and gain settings at all seven stages.

6.2.1. Power Output Section: Limiting and Sensitivity

The Current Peak Limiter (CPL) dynamically limits the drive to the power stage based on three parameters: sensed output current level, feedback from the output stage, and sensed voltage clip from the ISVPL. This ensures that power output is maintained within the design limits of the PLM+.

The adjustable Inter-Sample Voltage Peak Limiter (ISVPL) sets the PLM+'s maximum output voltage and therefore also the maximum output power. The ISVPL setting is made via MENU > MODULE > LIMITERS > ISVPL, and can also be set from the Lake Controller software.

The sophisticated output section monitors faults and generates warnings when appropriate; warnings are displayed on the front panel of the PLM+ and also sent as messages over the control network. In the rare event that maximum ratings are significantly exceeded, the PLM+ will mute until the condition has been rectified or the incorrect setting has been readjusted. Sensing circuits also transmit local output power stage temperature, processor card temperature, and PSU temperature to the appropriate protection circuits. Please refer to section 5.3 further details.

Table 6.2 lists PLM+ Series analog input sensitivity in dBu and Vrms for various Amp Gain settings and maximum/minimum ISVPL settings, assuming an analog input headroom of 26 dBu.

Input Sensitivity				
ISVPL SETTING	194 V		17.8 V	
GAIN (dB)				
+44	+1.0	0.87	-19.8	0.08
+41	+4.0	1.22	-16.8	0.11
+38	+7.0	1.73	-13.8	0.16
+35	+10.0	2.44	-10.8	0.22
+32	+13.0	3.45	-7.8	0.32
+29	+16.0	4.87	-4.8	0.45
+26	+19.0	6.88	-1.8	0.63
+22	+23.0	10.90	+2.2	1.00

Table 6.2: Analog Input Sensitivity in dBu and Vrms

6.3. Lake Processing and Control

As outlined in section 2.2.3, this device integrates seamlessly into the Lake Processing environment, providing all features, functionality and connectivity associated with all Lake Processors. The internal Lake Processing includes programmable crossovers, EQ, dynamics and other functions, and can be fully controlled via the Lake Controller software with a version number of 6.3 or later. Additionally, many functions can be controlled or accessed directly via the front panel.

Visit <http://labgruppen.com> to download the latest software, firmware and documentation for your devices.

6.4. Modules and Frames

6.4.1. Overview

A Frame represents one physical Lake Processor device (e.g. PLM 12K44). A maximum of four Modules are contained within each Frame; these are referred to as Module A, B, C and D. The number of Modules shown in a given Frame is dependent upon the signal processing configuration of that Frame.

Each Module can be configured as a Classic Crossover (Bessel, Butterworth, Linkwitz-Riley), as a Linear Phase Crossover, or as multiple full bandwidth Auxiliary Outputs. The default configuration for the PLM+ is 4 x Contour Classic 1 Way (CL1-Way) Output Modules, providing a total of twelve Module outputs that can be routed to any of the four power outputs.

Please refer to the Lake Controller Operation Manual for further information.

6.4.2. LoadLibrary™ and Fingerprints

In addition to the standard loudspeaker presets (Module files), the Lake Controller also includes a set of enhanced Module files specifically for use with the PLM and PLM+ Series.

These supplementary PLM+ Module files, known as the LoadLibrary, incorporate both Lake DSP parameters along with PLM+ specific data; LoadLibrary Module files include parameter settings for the Amplifier Gain and ISVPL limiter. Additionally, LoadLibrary loudspeaker types may also include data relating to the electrical characteristics of a particular loudspeaker.

Electrical characteristic data is used to enable load verification (LoadSmart) to be performed on the PLM+. This data set is termed a Fingerprint. When a PLM+-specific loudspeaker type is loaded, its Fingerprint load characteristics are included. These load characteristics are stored in a file with a “.mdl” suffix and are loaded simultaneously with the module file.

6.5. Loudspeaker Processor Overview

The Lake Processing system within PLM+ Series devices may be configured with up to four processing Modules containing a total of up to twelve processing Module outputs, that can be routed to any of the four power output channels.

Each set of processing elements is referred to as a Module and can be configured as crossovers, full bandwidth auxiliary outputs, or a combination of the two. The relationship between inputs and outputs is defined via the Lake Controller or via the front panel Input Config Menu.

The Lake Processing system provides two distinct categories of crossovers:

- Infinite Impulse Response filters (IIR) such as the classic Bessel, Butterworth or Linkwitz-Riley types; these are available with slopes ranging from 6 dB/octave to 48 dB/octave.
- Finite Impulse Response filters (FIR) providing zero phase shift with steep transition slopes at the crossover frequencies. These are also referred to as Linear Phase Crossovers.

6.6. Files and Presets

The Lake system provides various methods for storing and recalling Module, Frame, or system-wide data. An overview is provided below; for further information please refer to the Lake Controller Operation Manual.

6.6.1. Module, System and Sub-System Configuration Files

Module, System and Sub-System Configuration files are stored on the Lake Controller PC, and data is passed across the network when recalling or storing these type of files.

- A Module file is the smallest set of data that can be stored and recalled; it contains crossover, gain, delay, and limiter information for an individual loudspeaker (see Figure 6.1).
A Module file may be recalled into other Lake devices. It is not possible to store a Module File directly on the hardware device.
- A System or Sub-System Configuration File contains a set of Module file information in addition to Frame related information such Group data and I/O configuration (see Figure 6.1).

6.6.2. Frame and System Presets

The entire processor configuration can be stored as a Frame Preset on this hardware device. Presets can be recalled via the front panel (refer to section 7.11.7) or via the Lake Controller software or Preset Manager utility; presets can be stored using the Lake Controller software or Preset Manager utility.

A maximum of 100 Frame Presets can be stored on this device. The data within a Frame Preset includes the configurations of all Modules in the Frame, including levels, crossover, EQ, input mixer, routing, and all other parameters. As Frame Presets are stored in the hardware device, recall is available without using a PC.

Using the System Presets function in the Lake Controller, entire system configurations can be stored and recalled across a network of LM, PLM and PLM+ Series devices. This enables fast retrieval and switching of entire system configurations as minimal data is being sent between the Controller and Processors.

7. Front Panel Interface

An overview of the front panel interface is provided in section 4.1. This chapter describes each cluster of controls as shown in the diagram below.



7.1. Overview

The front panel interface is framed by two sturdy cast aluminium handles ❶ and metal grill protecting the air intake and dust filters ❷. The majority of PLM+ functions can be controlled and/or monitored via the frontpanel LCD display screen ❸, power button ❹, function buttons ❺ ❻ ❼ ❽ ❾ ❿ and rotary encoder ⓫.

7.1.1. Operating Modes

The front panel has two basic modes: Meter Mode and Menu Mode.

- Meter Mode provides the following views: Home view, Amplifier Meters view / LoadPilot view, Temperature Meters view, Input Meters view and Module Meters view. To navigate through these views, press the METER button or turn the rotary encoder button. Please refer to section 7.10 for further information on Meter Mode.
- Menu Mode provides various menus for viewing and editing parameters and is selected by pressing the MENU button. Select the required submenu by pressing the associated button.

7.1.2. Warning, Fault and Mute Indications

Fault or warning conditions are indicated via the LEDs embedded in the dynamic function buttons; a simultaneous description is shown adjacent to the button, on the LCD. The LEDs to the left of the LCD indicate problems with the PLM+ or its inputs, while those to the right indicate problems with the power output channels.

Please note that the same LEDs also indicate the mute status of inputs (left) and outputs (right). Further information on faults and warnings can be found in section 9.1.

7.1.3. Selecting a Module in the Lake Controller software via the Front Panel

It is sometimes useful to identify which Module icon/s in the Lake Controller software are associated with a particular hardware Frame. To highlight the module in the Lake Controller software:

1. Ensure Meter Mode is selected and in Module view.
2. Press the button adjacent to the Module description on the left LCD. The corresponding module will show highlighted text on the Lake Controller screen.

If the Frame is online, but the Module is not in the work area, the selected Module will be centered on the Module scroll bar (assuming the Modules Menu is selected in the Lake Controller).

7.2. Front Panel Key Lock

It is possible to lock the front panel buttons for security purposes. When this function is active, all front panel controls (except power state) are disabled and all adjustment must be made via the network. To lock controls, press and hold button **A** then simultaneously press button **B** as shown in Figure 7.2; repeat this process to unlock.

1. Press + Hold **A**



2. Press **B**

Figure 7.2: Locking / Unlocking Front Panel Controls



NOTE: A key icon will appear at the top of the display when the Front Panel is locked.

7.3. Power Button

The unit is powered on by pressing the top-left button on the front panel, labelled **4** in Figure 7.1. It has a bi-color power symbol which illuminates red when connected to the AC mains and the unit is in standby mode. It turns green when the button is pressed to turn the unit on. A subsequent press of this button returns the unit to standby mode.

7.4. Mute Enable Button

The dynamic function buttons to the immediate left and right of the LCD are used as MUTE buttons only when the MUTE ENABLE button **5** is activated (flashing).

When MUTE ENABLE is activated the MUTE ENABLE button will flash and the four buttons on the left act as Module or Input Router mute controls (depending on active view) and the four buttons on the right enable muting/unmuting of the Amplifier Channel (power outputs).

In Meter Mode > Home View with MUTE ENABLE activated, text on the LCD adjacent to each button indicates when a Module input or Amplifier Channel power output has been muted. Meter Mode must be selected for MUTE ENABLE to be activated; MUTE ENABLE is not available in Menu Mode.

To exit MUTE ENABLE mode, press the flashing MUTE ENABLE button. If no mute activity occurs for two minutes, MUTE ENABLE mode will automatically be disabled.

7.5. Meter Button

The front panel display has two main operating modes, Meter Mode (default) and Menu Mode. In normal operation, the display will be in Meter Mode.

The following views are available in Meter Mode: Home View (default), Amplifier View / LoadPilot View, Temperature View, Input View and Module View. Pressing the METER **6** button scrolls through these views. Pressing the METER button when in Menu Mode will return the system to Meter Mode, with the Home View displayed.

7.6. Menu Button

Menu Mode is selected by pressing the MENU button **7**. The screen displays the top level menu with various submenu options. Press the button adjacent to the required submenu to select it.

Pressing the MENU button while in Menu Mode will display the previous menu level.

Menu Mode is used for processor configuration, or for editing a parameter. Please refer to section 7.11 for further details.

7.7. Exit Button

In Menu Mode, pressing the EXIT button **12** returns back one menu level. In Meter Mode, pressing EXIT returns the display to the Home View.

7.8. Dynamic Buttons, Controls and LEDs

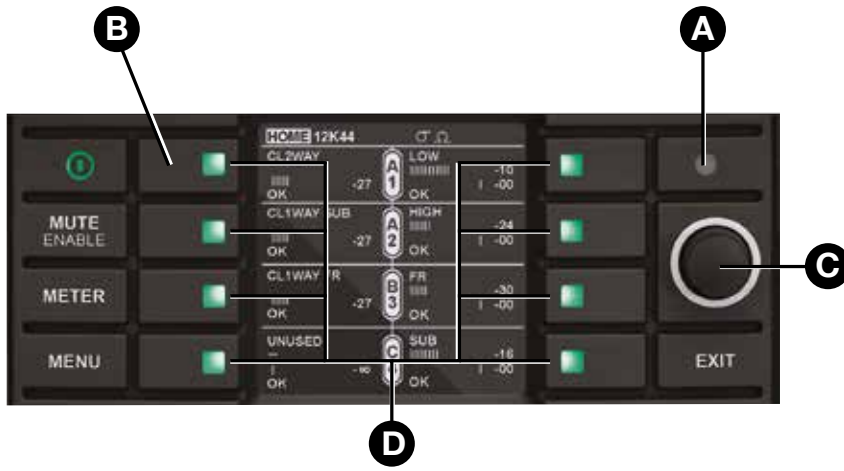

Figure 7.3: LCD with Dynamic Buttons, Controls and LEDs

7.8.1. Communication LED **A**

This bright white LED signifies selection in the Lake Controller, or Controller communication providing visual confirmation of:

1. Network communication between the Lake Controller and the Lake Processor (Flashing LED).
2. Selection of the Lake Processor in the Lake Controller software (Steady LED).



NOTE: The Communication LED can be dimmed via the front panel by selecting Frame menu, and then Front > Dimming. Dimming affects all LEDs as well as the backlight of the display.

7.8.2. Frame Faults and Warnings LED **B**

All four LEDs on the left flash/off red to indicate a Frame fault and flash yellow/mute state to indicate a Frame warning. Additional clarification of the current fault or warning is displayed in the bar of the LCD. All mute, fault and warning states displayed on the front panel are summarized in section 9.1.

Additional faults and warnings are reported in the Event Log of the Lake Controller only. All faults and warnings recorded in the Event Log are listed in section 9.1 along with scenarios that may have arisen to cause them.

7.8.3. Rotary Encoder

The rotary encoder is used to adjust parameters in conjunction with the selection made via the dynamic function buttons and LCD menus. The ring around the rotary encoder illuminates when a selected parameter is available for adjustment.

Turn the encoder clockwise to increase the selected parameter, or counter-clockwise to decrease the value. Parameters with only two states (e.g. ON, OFF) are toggled by turning clockwise or counter-clockwise. Some parameters enable simultaneous adjustment of a combination of input and output channels.

To select which channels are adjusted:

1. Press the associated soft button/s to select the parameter/s for editing. A selected parameter is indicated by inverse text and background color.
2. Use the rotary encoder to change the value.

It is possible to select multiple parameters for simultaneous editing even if the values are different on each channel. Turning the rotary encoder will adjust each parameter by the same increment. When in Meter Mode, the rotary encoder allows the user to change between the available meter views.



NOTE: Some menus permit parameters to be adjusted across multiple channels simultaneously by default.

7.8.4. Dynamic Function Buttons

The buttons surrounding the display are unlabeled because their functions change according to the currently selected menu or display.

In Meter Mode with MUTE ENABLE activated, these dynamic function buttons are used to mute or unmute the Module Inputs and power output channels.

In Menu Mode these buttons are used to navigate the menu structure. This is indicated by a thin line on the display closest to the button used. During menu navigation, the color of the embedded LEDs continues to indicate the mute status, clips, or faults and warnings relevant to the associated input or output channel on the PLM+.



NOTE: Each button contains a tricolor LED which conveys fault and warning indications in addition to the mute status. The LED color does not necessarily correspond to the currently selected function.

7.8.4.1. Mute Functions

The PLM+ provides mute functions at several different points in its audio chain. Please refer to section 6.1 for further information. The four types of mute are:

1. PLM+ Input Router Mute
2. Module Input Mute
3. Module Output Mute
4. Power Output Mute

With the exception of Module output mutes, all types may be controlled from the PLM+ front panel in Meter Mode by activating MUTE ENABLE and selecting the associated input or output Meter View using the METER button. Module Output Mute is available in Menu mode Module > Mute.



NOTE: Module input and output mutes can be controlled in Menu Mode via the MENU button. All mutes can also be controlled from the Lake Controller.

7.8.4.2. PLM+ Input Router Mute

The PLM+ Input Router mute provides the ability to simultaneously mute/unmute all modules or outputs that are sourced from the PLM+ input. To mute or unmute the PLM+ inputs:

1. Press METER until the Input Meter View is displayed
2. Press MUTE ENABLE
3. Use the associated dynamic function buttons to mute / unmute the PLM+ input router to the left.



NOTE: The PLM+ Input Router Mute is within the Lake Processing system, post input type selection, and pre input mixing and routing.

Please refer to the Lake Controller User Manual for details of mute selection via the software.

7.8.4.3. Module Input Mute

The Module input mute provides the ability to mute/unmute the audio signal at the module level. Therefore, the PLM+ Input Router (described in section 7.8.4.2) remains unmuted and can be used by another module. To mute or unmute a Module input:

1. Press METER until Home View is displayed
2. Press MUTE ENABLE
3. Use the associated dynamic function buttons to mute / unmute the Module inputs

Once the Module input is muted, the LED turns red and MOD. IN MUTE is displayed on the LCD. When unmuted, the LED turns green (unless any other output warning conditions are active).



NOTE: Fault condition LED indications take priority over mute status indications. If a fault condition occurs, the LED will indicate the fault by flashing and will note the mute status. When a Frame fault is active the audio on all channels is muted.

Module Input Mutes may also be controlled in Menu Mode.

Please refer to the Lake Controller User Manual for details of mute selection via the software.

7.8.4.4. Module Output Mute

Module Output Mute is part of the Lake Processing system, at the crossover outputs. It is post Module output EQ and level adjustment, pre PLM+'s protection circuitry.

Muting of the Module outputs is available via MUTE ENABLE in Module Meters view, as the PLM+ power output mutes are assigned in this mode (see section 7.8.4.5). However, Module output mute status and control are also available in Menu Mode and may also be viewed and controlled from the Lake Controller software.

Please refer to section 7.11.2.7 for details of selecting Module Output Mute in Menu Mode.

Refer to the Lake Controller User Manual for details of mute selection via the software.

7.8.4.5. Power Channel Mute

The four dynamic function buttons to the right of the LCD control the Power Output Mutes of output channels 1-4. These mutes are located within the PLM+'s power output stage.

When a PLM+ power output is muted, the LED turns red and the text AMP CH. MUTE is displayed on the LCD. When unmuted, the LED turns green (unless any other output warning conditions are active).



NOTE: Fault condition LED indications take priority over mute status indications. If a fault condition occurs, the LED will indicate the fault and not the mute status.

7.8.5. LED Fault, Warning and Clip Indication **B** **D**

A tricolor LED is embedded inside each of the eight dynamic function buttons. The LEDs convey a variety of status indications including faults and warnings, signal clip indications, Module input mute, Module output mute and Power Output mute. Table 7.4 summarizes the meaning of the LED indications.

LED Color	Indication
Green	Status Good / Unmuted
Yellow	Warning
Red	Fault / Muted
Flashing Red	Clip

Table 7.4: LED Fault and Warning Indications



NOTE: An unlit output LED indicates either the channel is not available for the model in use, or that the power output channel is not routed to a Module output channel.

7.8.5.1. Clip Indication

The front panel LEDs also indicate input and output clip or pre-clip conditions that can occur within the PLM+.

Input Clip

Input clipping is monitored at two stages in the signal path:

- Analog Input Stage: If the input signal exceeds either +26 dBu, a clip indication is displayed.
 - A warning is displayed at +24 dBu (i.e. 2 dB from Clip)
- Module Input Stage: If the signal level at this point exceeds +21 dBu, a clip indication is displayed.

Input clipping is indicated by the affected Module LED flashing red and INPUT CLIP displayed on the LCD. If a subsequent input clip within 400 ms is detected, the LED remains lit for a longer period.

Output Clip

All output channels are monitored by a suite of protection circuits that include a Current Peak Limiter (CPL) and an Inter-Sample Voltage Peak Limiter (ISVPL).

The ISVPL will indicate clip only when exceeding the amplifier's maximum output voltage. If the ISVPL is set so as to limit the output below maximum voltage, then clip indication will not occur when reaching the ISVPL threshold. Please refer to section 5.3 for further information.

If CPL protection is active, or a voltage clip occurs, then the associated Power Output Channel LED will flash red and a text warning will be displayed on the screen.

7.8.5.2. Warning or Fault Indications

If certain parameters within the PLM+ approach or exceed preset limits, a warning condition or fault condition may arise. One or more LEDs provide a visual indication of the problem, along with an on-screen description of the condition displayed adjacent to the LED/s.

- A green LED confirms inputs or outputs are unmuted and operating normally
- A yellow LED signifies a warning of potential problems in the PLM+ amplifier stages
- A red LED indicates a fault, clip or mute

An Event Log file lists all warnings with date and time stamps; please refer to the Lake Controller Operation Manual for further information the Event Log.

Please refer to Table 9.1 for a detailed description of faults and warnings.

7.9. Warning and Fault Indications

Table 7.5 lists the warning conditions signified by a yellow LED; Table 7.6 lists the fault conditions signified by a red LED.

On Screen Warning Text	Type	LED No.	Warning	Event Log Text
ATL ACTIVE	Frame	1	Amp Temp Limit	N/A
CLOCK SLIPPING	Module	1	AES Clock Slipping	AES Clock Slipping
TEMP WARN:CH	Channel	5-8	Amp Temp Warning	Temp Warning: Amp Channel
BEL ACTIVE	Frame	1	BEL Active	N/A
CTRL OFFLINE	Frame	1	Controller Offline	N/A
NAME CONFLICT	Frame	1	Device Name Conflict	Dante Device Name Conflict
OFFLINE	-	1	Frame Offline	Frame Offline
LOAD NOT VER	Module Channel	2+3 5-8	Load Not Verified	LoadSmart: Load Not Verified
UNCERTAIN LOAD	Channel	5-8	Load Uncertain	Uncertain About Load Type
MAINS GLITCH	Frame	1	PSU Mains Glitch	Glitch on Mains Voltage Detected
PAL ACTIVE	Frame	1	PSU Power Limit	N/A
PTL ACTIVE	Frame	1	PSU Temp Limit	N/A
TEMP WARN:PSU	Frame	1	PSU Temp Warning	Temp Warning: Power Supply Unit
SENSE FAULT	Frame	1	Sense Fault	Frame Warning: Sense Fault
SPKR SHORTED	Channel	5-8	Speaker / Cable Shorted	Speaker / Cable Shorted
OVER SPKR CNT	Channel	5-8	Speaker Over Count	Over Speaker Count
UNDER SPKR CNT	Channel	5-8	Speaker Under Count	Under Speaker Count
SPKR DAMAGED	Channel	5-8	Speaker Damaged	Speaker Component Damaged
SPKSAFE INACT	Channel	5-8	SpeakerSafe Not Started	SpeakerSafe Not Started
LM PREC. LOW	Channel	5-8	SpeakerSafe Precision Low	Speaker Precision Low
UVL ACTIVE	Frame	1	Under Voltage Limit	N/A
VHF WARNING	Channel	5-8	Gain reduction activated	VHF Warning

Table 7.5: Warning Conditions (Yellow LED)

On Screen Warning Text	Type	LED No.	Warning	Event Log Text
AMP CH. MUTE	Channel	5-8	Fault/Clip Mute	Amp Channel Mute
TEMP FLT:CH	Channel	5-8	Amp Temp Fault	Temp Fault: Amp Channel
CHECK AC MAINS	Frame	1	Check AC Mains	Frame Fault: Check AC Mains
CAL ACTIVE	Channel	5-8	Current Average Limiter	N/A
CURRENT CLIP	Channel	5-8	Current Protection Limiter	N/A
TEMP FLT:DSP	Frame	1	DSP Area Temp Fault	Temp Fault: DSP Area
INPUT MUTE	Inp.Mix	2+3	Input Channel Mute	Input Mute
AUDIO FAULT	Frame	1	Internal Audio Interface Fault	Frame Fault: Audio Interface
MOD. IN MUTE	Module	2+3	Module Input Mute	Module Input Mute
MOD. CLIP	Module	2+3	Module Output Clip	N/A
MOD. OUT MUTE	Channel	5-8	Module Output Mute	Module Output Mute
NO INPUT	Module	2+3	No Input Source Available	No Input Source
NO LOAD	Channel	5-8	No Load Detected at Output	Channel Fault: No Load Detected
INPUT CLIP	Module	2+3	Physical Input Clip	N/A
SERVICE CH.	Channel	5-8	Power Channel Failure	Channel Fault: Unit Needs Service
TEMP FLT:PSU	Frame	1	PSU Area Temp Fault	Temp Fault: Power Supply Unit
MAINS > 400 VPK	Frame	1	PSU Mains Over Voltage Peak	Frame Fault: PSU Mains > 400 VPK
MAINS > 270 V	Frame	1	PSU Mains Over Voltage RMS	Frame Fault: PSU Mains > 270 V
MAINS < 65 V	Frame	1	PSU Mains Under Voltage	Frame Fault: PSU Mains < 65 V
NEEDS SERVICE: 1	Frame	1	PSU Needs Service 1	Frame Fault: Needs Service: 1
NEEDS SERVICE: 2	Frame	1	PSU Needs Service: 2	Frame Fault: Needs Service: 2
NEEDS SERVICE: 3	Frame	1	PSU Needs Service 3	Frame Fault: Needs Service: 3
NEEDS SERVICE: 4	Frame	1	PSU Needs Service: 4	Frame Fault: Needs Service: 4
NEEDS SERVICE: 5	Frame	1	PSU Needs Service 5	Frame Fault: Needs Service: 5
NEEDS SERVICE: 6	Frame	1	PSU Needs Service: 6	Frame Fault: Needs Service: 6
NEEDS SERVICE: 7	Frame	1	PSU Needs Service 7	Frame Fault: Needs Service: 7
NEEDS SERVICE: 8	Frame	1	PSU Needs Service: 8	Frame Fault: Needs Service: 8
PSU POWER PROT	Frame	1	PSU Rail Protect	Frame Fault: PSU Power Protect
SHORT CIRCUIT	Channel	5-8	Short Circuit Protection	Channel Fault: Short Circuit Protection
VHF FAULT	Channel	5-8	VHF Protection	Channel Fault: Very High Frequency
VOLTAGE CLIP	Channel	5-8	Voltage Peak Limiter	N/A
WRONG LOAD	Channel	5-8	Wrong Type of Speaker	Load Type / Routing Mismatch

Table 7.6: Fault Conditions (Red LED)

7.10. Meter Mode

7.10.1. Home View

The default view when powering on the device is Meter Mode > Home View as shown in Figure 7.7.



Figure 7.7: Meter Mode > Home View

Home View provides a summary of Module I/O gain level and limiter gain reduction, along with frame, module and channel labeling information. The example in Figure 7.7 shows a mono 2-way, with Module A feeding power output channels 1 & 2, and Module B configured as CL1-way feeding a subwoofer on power output channel 3. Module C is configured for driving a full-range loudspeaker on power output 4. Module D is unused in this example.

- ❶ Module A label, input gain meter, faults, warnings, clips & mutes.
- ❷ Module B label, input gain meter, faults, warnings, clips & mutes.
- ❸ Module A label, input gain meter, faults, warnings, clips & mutes.
- ❹ Module D label, input gain meter, faults, warnings, clips & mutes.
- ❺ Module output label for Power channel 1, gain & sum of Lake MAX-Peak, MAX-RMS and ISVPL gain reduction faults, warnings, clips & mutes.
- ❻ Module output label for Power channel 2, gain & sum of Lake MAX-Peak, MAX-RMS and ISVPL gain reduction faults, warnings, clips & mutes.
- ❼ Module output label for Power channel 3, gain & sum of Lake MAX-Peak, MAX-RMS and ISVPL gain reduction faults, warnings, clips & mutes.
- ❽ Module output label for Power channel 4, gain & sum of Lake MAX-Peak, MAX-RMS and ISVPL gain reduction faults, warnings, clips & mutes.
- ❾ Menu Bar: Current View title & Frame label, Frame faults and warnings. The menu bar is located by default at the top of the display, but can be configured in the front panel menu for placement at the bottom. The following indications, as active or applicable, also are shown on the menu bar.

Ω - AES3 Input Terminated (no icon = Unterminated)

⊥ - Analog Inputs Iso-Float Grounded (no icon = Floating)

⌚ - Dante Clock Master (no icon = Dante Slave or Dante Disabled)

⌚ - Dante Slave Only (no icon = device may be used as Dante Clock Master)

REDUNDANT - Dual Redundancy networking enabled. (No icon = configured for switch mode)

Please refer to Table 7.5 and Table 7.6 for full details on the faults and warnings that could be displayed in any of the above locations.



Note: Output limiter (gain reduction) meters take into account the sum of PLM+ ISVPL and Lake LimiterMax.

⑩ The icons in the center of the LCD indicate the amplifier channel to which each module output is routed. When two amplifier channels are Bridged, both channels will be displayed.

The type of icon used in the center of the screen confirms whether the PLM+ outputs are configured in Standard mode or Bridge Mode, as shown in Figure 7.8 For further information on Bridge Mode, please refer to section 8.1.1.



Figure 7.8: Standard and Bridge Mode Front Panel Icons (only for PLM 12K44 and PLM 20K44)

Bridge Mode is visible via this icon notation on the PLM+ Front Panel in Home View, however, the Lake Controller must be used to configure Bridge Mode; please refer to the Lake Controller Operation Manual for further information.

Home View looks similar for most configurations, with slight variations dependent on the PLM+ model and processor configuration.

7.10.2. Amplifier Meters View

Amplifier Meters View provides further signal level information in the form of additional power output meters as shown in Figure 7.9.



Figure 7.9: Meter Mode > Amplifier Meters View

- ① Output 1: V - Voltage Meter I - Current Meter P - Power Meter L - Gain Reduction Meter
- ② Output 2: V - Voltage Meter I - Current Meter P - Power Meter L - Gain Reduction Meter
- ③ Output 3: V - Voltage Meter I - Current Meter P - Power Meter L - Gain Reduction Meter
- ④ Output 4: V - Voltage Meter I - Current Meter P - Power Meter L - Gain Reduction Meter
- ⑤ LoadPilot Status: 1. High Freq Pilot tone Enabled/Disabled, 2. Low Freq Pilot tone Enabled/Disabled, Status

- ⑥ LoadPilot Status: 1. High Freq Pilot tone Enabled/Disabled, 2. Low Freq Pilot tone Enabled/Disabled, Status
 - ⑦ LoadPilot Status: 1. High Freq Pilot tone Enabled/Disabled, 2. Low Freq Pilot tone Enabled/Disabled, Status
 - ⑧ LoadPilot Status: 1. High Freq Pilot tone Enabled/Disabled, 2. Low Freq Pilot tone Enabled/Disabled, Status
 - ⑨ Current View title & Frame label, Frame faults and warnings
- The Voltage Meter (V) indicates the power output stage voltage relative to its clip level
 - The Current Meter (I) indicates the current the power output stage is driving into its load, relative to the maximum permissible current the fixed CPL allows
 - The Power Meter (P) indicates the instantaneous output power being developed in the load relative to the PLM+s maximum output power capability.
 - The Gain Reduction Meter (L) indicates the degree of limiting being applied by the PLM+ ISVPL and/or the Lake LimiterMax.

7.10.3. Temperature View

Temperature View provides information about the current operating temperatures within the PLM+. Selected fuse type, as well as Mains Voltage and Current draw.



Figure 7.10: Meter Mode > Temperature View

- ① Current View title. Power supply temp (PSU) & Lake processor temp (DSP) as percentage of maximum
- ② Unused in Temperature View
- ③ Unused in Temperature View
- ④ Breaker Emulation Limiter; selected Fuse type - Mains Voltage - Mains Current Draw
- ⑤ Output 1: AMP - Temp of power output as percentage of maximum
- ⑥ Output 2: AMP - Temp of power output as percentage of maximum
- ⑦ Output 3: AMP - Temp of power output as percentage of maximum
- ⑧ Output 4: AMP - Temp of power output as percentage of maximum
- ⑨ Current View title & Frame label, Frame faults and warnings

7.10.4. Input Meters View

Input View enables inspection of the source selected to each input router; input signal level before the input mixer (i.e. prior to the Home View Module input meters); Module Input Mixer Routing; as well as Input Connection status.



Figure 7.11: Meter Mode > Input Meters View

- ❶ Input Router 1: Selected input type, input gain level (relative to clip), router fault/warning/clip
- ❷ Input Router 2: Selected input type, input gain level (relative to clip), router fault/warning/clip
- ❸ Input Router 3: Selected input type, input gain level (relative to clip), router fault/warning/clip
- ❹ Input Router 4: Selected input type, input gain level (relative to clip), router fault/warning/clip
- ❺ Module A Input Mixer, Module A input level meter, Input 1 Connection Status
- ❻ Module B Input Mixer, Module A input level meter, Input 1 Connection Status
- ❼ Module C Input Mixer, Module A input level meter, Input 1 Connection Status
- ❽ Module D Input Mixer, Module A input level meter, Input 1 Connection Status
- ❾ Current View title & Frame label, Frame faults and warnings

7.10.5. Module Meters View

Module View provides further signal level information in the form of additional power output meters as shown in Figure 7.12.



Figure 7.12: Meter Mode > Module Meters View

- ❶ Module A label and input gain meter
- ❷ Module B label and input gain meter
- ❸ Module C label and input gain meter
- ❹ Module D label and input gain meter

- 5 Output 1: Output Label - Output Gain Meter - Lx: Sum of Lake MAX-Peak and MAX-RMS gain reduction
- 6 Output 2: Output Label - Output Gain Meter - Lx: Sum of Lake MAX-Peak and MAX-RMS gain reduction
- 7 Output 3: Output Label - Output Gain Meter - Lx: Sum of Lake MAX-Peak and MAX-RMS gain reduction
- 8 Output 4: Output Label - Output Gain Meter - Lx: Sum of Lake MAX-Peak and MAX-RMS gain reduction
- 9 Current View title & Frame label, Frame faults and warnings

7.11. Menu Mode

7.11.1. Overview

The majority of functions can be accessed via Menu Mode on the front panel. These functions include the adjustment of gain, delay, limiters, input and output routing, and the ability to recall Frame Presets. Menu Mode can be accessed at any time by pressing the MENU button.

After pressing the MENU button, various submenu options are displayed as shown in the figure below.



Figure 7.13: Menu Mode > Main Menu

Press the illuminated button adjacent to the required option to display an associated submenu. When parameter level is reached, individual parameters may be selected for adjustment by pressing the adjacent button. The selected parameter value/s are highlighted, and are adjustable using the rotary encoder.

A parameter may be adjusted simultaneously across multiple channels by selecting all values to be adjusted; any current value offsets are retained. Some parameters default to multiple selections, with all inputs or outputs adjusted simultaneously. Changes are effected in real-time and are stored without further confirmation. Pressing EXIT returns to the previous menu level, automatically retaining any parameter changes.



Note: All parameters are also editable via the Lake Controller unless specified otherwise.

7.11.1.1. Parameters with Individual Values and Group Totals

The following parameters display two values:

- MODULE > GAIN
- MODULE > DELAY
- MODULE > LIMITERS > MAXRMS LEVEL
- MODULE > LIMITERS > MAXPEAK LEVEL

The Module parameter can be adjusted using the rotary encoder. The Group total (shown in brackets) is only adjustable using the Groups function in the Lake Controller.

The Group total is the sum of the individual Module value plus any values for this parameter on all Groups to which the Module is assigned. Please refer to the Lake Controller Operation Manual for further information on Groups.

7.11.1.2. Menu Structure Overview

From the Main Menu, the following submenus are available, as shown in Figure 7.13 and described in the following sections.

- MODULE (See section 7.11.2)
 - Input Mixer
 - Gain
 - Delay
 - Polarity
 - Amp Gain
 - Limiters
 - Mute
- INPUT/OUTPUT CONFIGURATION (See section 7.11.3)
 - Input Router 1 - 4
 - AES Termination
 - Iso-Float
 - Output Router
- ATTENUATION (See section 7.11.4)
- FRAME (See section 7.11.5)
 - Frame Information
 - Frame Reset
 - BEL Configuration
 - Network
 - Latency Match
 - Front Panel
- FRAME PRESETS (See section 7.11.7)
 - Preset Recall

- LOAD MONITOR (See section 7.11.8)
 - Configure No. of Cabinets in Parallel
 - LoadSmart Verification
 - Estimated No. of Cabinets

7.11.2. Module Submenu

Only module output channels for routed Power channels are displayed. This applies to all module output configurations described below.

MENU > MODULE

After selecting the Module Menu, the screen shown in Figure 7.14 is displayed. Press the illuminated button adjacent to the required option to view or edit the associated parameters.



Figure 7.14: Module Submenu

7.11.2.1. Input Mixer

MENU > MODULE > INPUT MIXER

Press the illuminated button next to Input Mixers A – D. Selected mixer will show four Routers (1-4) adjacent to the right-hand buttons. Use buttons to select Router(s) and use the rotary encoder to change level values within defined limits to configure the mixer. Multiple Routers may be selected simultaneously.



Figure 7.15: Input Mixer

7.11.2.2. Gain

MENU > MODULE > GAIN



Figure 7.16: Module Gain Edit Screen

Press the illuminated button next to the module input/s and/or output/s for adjustment, and use the rotary encoder to change the value(s). Multiple gain values may be adjusted simultaneously in 0.1 dB increments, subject to defined level limits.

7.11.2.3 Delay

MENU > MODULE > DELAY

Press the illuminated button next to the input/s and/or output/s for adjustment, and use the rotary encoder to change the value/s. Multiple delay values may be adjusted simultaneously in 0.1 ms increments, subject to defined level limits.

The audio signal may be delayed (typically for reasons of driver or delay subsystem alignment) at either the Module inputs or on individual outputs. Delay added at the inputs affects all outputs equally, and will be generally be introduced to time-align arrays of loudspeakers at different locations. Delaying individual outputs may be desirable to time-align drivers in the same cabinet or array.

7.11.2.4. Phase (Polarity)

MENU > MODULE > PHASE

Press the illuminated button next to the input/s and/or output/s to be adjusted, and use the rotary encoder to change the value/s. Phase may be changed on one input or output at a time.

Audio phase reversal is available at the inputs to Modules A - D, and also individually on the four output channels. The LCD displays 'Positive' for normal operation and 'Negative' when the phase is inverted.

7.11.2.5. Amp Gain

MENU > MODULE > AMP GAIN

By default, all outputs are selected; use the rotary encoder to change the gain of all power outputs or press the associated output button to deselect one or more outputs.

Amp Gain adjusts the gain of the PLM+'s power output stage for each output channel. The default setting is 35 dB, variable in 0.1 dB increments from 22 dB to 44 dB. Care should be taken in altering Amp Gain, which should be adjusted in conjunction with the Gain controls and limiter thresholds.

7.11.2.6. Limiters

MENU > MODULE > LIMITERS

Various parameters of the PLM+'s Inter-Sample Voltage Peak Limiter (ISVPL) and the Lake LimiterMax can be adjusted via this submenu. By default, simultaneous adjustment of most limiter parameters across all output channels is selected, although channels may be adjusted individually if required. Attack and Release times must be adjusted individually per module DSP channel.

Inter-Sample Voltage Peak Limiter Threshold (ISVPL Threshold)

The ISVPL prevents the voltage of the PLM+ outputs from exceeding a pre-determined value. The ISVPL Threshold can be adjusted between 17.8 V to 600 V, which represents the instantaneous peak voltage, not the RMS value of the output signal. The actual value is displayed in brackets and can be limited by the maximum voltage a particular PLM+ Series model can produce and/or by the RPM Power allocation algorithm. In the ISVPL menu, the default voltage is displayed. To see the Amplifier Maximum with RPM, please refer to the technical data sheet. If the voltage shown is above the default voltage, then RPM is enabled on that channel.

Inter-Sample Voltage Peak Limiter Profile (ISVPL Profile)

Selecting the ISVPL Profile will optimize the ISVPL limiting for the specific frequency band. ISVPL Profile permits individual adjustments per channel between six profiles, providing appropriate attack and release times for the ISVPL Limiter and Voltage Clip feedback to either minimize distortion or maximize SPL as described below.

1. Universal – Inter Sample, Optimized for low distortion, usable for all frequencies
2. Sub/LF – Inter Sample, Optimized for higher SPL below 600 Hz, usable for all frequencies
3. Sub – Optimized for high SPL, 20 - 200 Hz
4. LF – Optimized for high SPL, 20 - 1200 Hz
5. MF – Optimized for high SPL, 300 - 6000 Hz
6. HF – Optimized for high SPL, > 1 kHz

The default ISVPL Profile is UNIVERSAL.

MaxPeak Level (MaxPeakLvl)

This sets the maximum peak signal level at the Module outputs. It is adjustable from -30 dBu to +30 dBu in 0.1 dB increments, subject to user-defined level limits. The Group total is displayed (in brackets) for each channel.

MaxRMS Level (MaxRMSLv)

This sets the maximum RMS signal level at the Module outputs. It is adjustable from -30 dBu to +30 dBu in 0.1 dB increments, subject to user-defined level limits. The Group total is displayed (in brackets) for each channel.

MaxRMS Corner (MaxRMSCor)

A soft-knee or hard-knee corner may be applied to the RMS Limiter. A soft-knee corner gently increases limiting as the signal approaches the threshold; a hard-knee corner applies full limiting to any signal exceeding the threshold by any amount, but none to signals below the threshold.

The Corner parameter is adjustable in 0.1 dB increments, subject to defined level limits. This figure represents the level below the limiter threshold at which compression commences; the larger this negative value, the softer the knee. A setting of 0 dB implies a hard-knee characteristic.



Note: LimiterMax provides peak and RMS limiting features, referred to as MaxPeak and MaxRMS respectively. Full details regarding LimiterMax can be found in the Lake Controller Operation Manual.

MaxRMS Attack

The attack time may be set for the RMS Limiter. Limiter release values are set separately for each of the four outputs in 0.10 ms increments.

MaxRMS Release

The release time may be set for the RMS Limiter. Limiter release values are set separately for each of the four outputs in 0.10 ms increments.

7.11.2.7. Mutes

MENU > MODULE > MUTES

In Meter Mode, Module inputs and PLM+ power output channels can be muted using the MUTE ENABLE function. The MUTE menu also provides mute status and control of the Module input mutes, but instead of the PLM+ power output channel mutes, it provides the ability to mute the Lake Module outputs.

Press the associated dynamic function button/s to select the Module input/s and/or Module output/s to be adjusted. Use the rotary encoder to toggle between the MUTED and UNMUTED states.

7.11.3. I/O Configuration

MENU > I/O CONFIG



Figure 7.17: I/O Configuration Sub Menu

This menu provides configuration options for input routing, along with settings for AES Termination and Iso-Float as described in the following sections.

7.11.3.1. Input Router Configuration

MENU > I/O CONFIG > ROUTER



Figure 7.18: Input Router 1

The signal flow diagrams in section 6 highlight that there are four Input Routers available on PLM+ Series devices. The input that is selected within the router can be used by the Input Mixer for any of the modules.

Each router has four priority levels allowing any input to be placed in a sequence providing automatic input signal fail over. Dante and AES3 inputs have priority over analog inputs.



Note: Only one analog input is allowed in each router, and the analog input must be at the lowest priority level in relation to any other inputs.

Two modes of input selection are available, Auto Select and Forced Selection. The selected setting is also visible from the I/O STATUS screen on the front panel, and via the Lake Controller.

In Auto Select mode, Priority 1 is checked for a valid input signal; if no signal is found, Priority 2 is checked, and so on until a valid signal is located; this process occurs if the currently selected input fails. In Forced Selection mode, one of the four priorities is fixed regardless of whether a valid signal is present.

7. Front Panel Interface

With a router selected on the front panel, press the middle button on the left of the LCD to activate this parameter for editing. Use the illuminated rotary encoder to scroll through the following options:

- Auto Select (default)
- Force Priority 1
- Force Priority 2
- Force Priority 3
- Force Priority 4

Assignment of Input Priority

Factory default settings assign Dante 1-4 to Priority 1, Dante 5-8 to Priority 2, AES3 1-4 to Priority 3 and Analog 1-4 to Priority 4. For example, for Input Router 1 Dante 1 on Prio1, Dante 5 on Prio2, AES3 ch1 on Prio 3 and Analog 1 on Prio 4

To change these settings via the front panel, select Priority slot number to be changed and use the rotary encoder to scroll through the available options. Due to the signal hierarchy it is not possible to assign an analog source to a higher priority than a digital source.

Analog Input Sensitivity and Digital Gain Offset

Press a dynamic function to the right of the LCD to toggle the selection of input source and input sensitivity/digital gain offset then use the rotary encoder to change the parameter.

The maximum input level accepted by the analog input pre-amplifiers without clipping is 26 dBu. Digital gain offset may be applied to Dante or AES3 digital input signals in 0.1 dB increments from -100 dB to +15 dB.

7.11.3.2. AES3 Input Termination

MENU > I/O CONFIG > AES TERM



Figure 7.19: AES Termination

To adjust the AES3 Input Termination, select AES TERM from the Input Config menu then use the rotary encoder to toggle the value. An icon is displayed in the bottom left of the display in Meter Mode when AES is set to 'Terminated'.

For fault-free operation when using AES3 digital audio as an input source, inputs must be correctly terminated with the characteristic impedance of 110 ohm. The Input Termination setting is determined by the method used to distribute the AES3 signals.

The PLM+ device at the end of a distribution line should be set to TERMINATED; all other PLM+ devices should be set to UNTERMINATED. If an AES3 distribution amplifier (DA) is being used to distribute the digital audio signals, with one DA output per processor, then all terminations should be on. However, if the AES3 is daisy-chained, only terminate the last PLM+ device in the chain.

7.11.3.3. Iso-Float

MENU > I/O CONFIG > ISO-FLOAT



Figure 7.20: Iso-Float

To change the Iso-Float setting, adjust the value using the rotary encoder. The current settings are also displayed on the front panel I/O STATUS screen.

The analog inputs utilize Iso-Float transformerless electronic balancing circuitry. This provides electrical isolation from an analog source comparable to that achieved with transformer-based designs. However, pin 1 of the XLR input connector may be connected to ground within the device if desired. This option is selected by using the rotary encoder to toggle between FLOATING and GROUNDED.

It may be necessary to change this setting to resolve ground loop problems when using analog inputs.

7.11.3.4. Output Router

MENU > I/O CONFIG > OUTPUT RTR

With PLM+ Series, Module output routing to Power outputs as well as AES or Analog to Dante output routing is accessible through the Front panel interface.

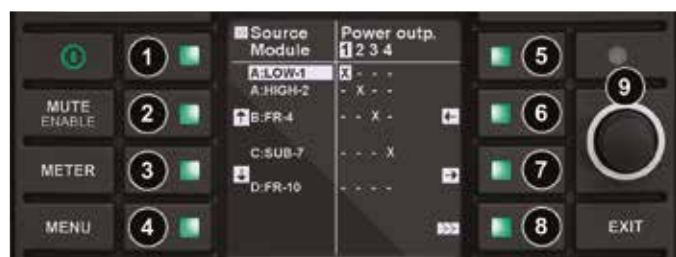

Figure 7.21: Output Router

7. Front Panel Interface

- ❶ Toggle the Source from which you want to route the channels (Module, Analog, AES) (NOTE: that this also may affect the destination, as only AES3 and analog can be routed to Dante).
- ❷ Toggle up among the available source channels
- ❸ Toggle down among the available source channels
- ❹ Unused
- ❺ Unused
- ❻ Toggle left among the available outputs
- ❼ Toggle right among the available outputs
- ❽ Disconnect all assignments
- ❾ Turn Right to Route / Turn Left to Un-route

Use the arrows visible on the display (2-3, 6-7) to toggle between available sources and outputs. Use the rotary encoder to select the output you want to connect to (power outputs or Dante). Selected output is marked with an “X” when routed and “O” when not routed.

Selecting 8 brings up a warning screen.

7.11.4. Attenuation Submenu

MENU > ATTENUATION

The default setting of 0.00 dB (i.e. no attenuation) is adjustable in 0.25 dB increments down to -100 dB. Adjustment of attenuation at the input to the PLM+ power stage is available on a per-channel basis. This adjustment is the PLM+ equivalent of a conventional amplifier level control. The power output channels may be turned down using these parameters before powering on or off. Please refer to the signal flow diagram in Figure 6.2.

By default, all channels are deselected. Press the SEL ALL button to select/deselect all channel, or, press a single button on the right to adjust a channel individually.



Note: Only ONE channel or ALL channels may be adjusted. It is not possible to adjust only two or three channels.

7.11.5. Frame Submenu

MENU > FRAME

The Frame Menu provides information and options relating to the device PLM+ as a physical unit. It is referred to as a Frame for consistency with Lake Controller terminology.

The Frame Label as defined in the Lake Controller is displayed in this menu. It is also displayed at the top-left of the screen in Meter Mode, Home View.

7.11.5.1. Frame Info

MENU > FRAME > FRAME INFO

Frame Info provides information about the device settings and configuration. All data in this front panel menu is read-only; some parameters are fixed, and some can be changed only via the Lake Controller software.

Firmware Version (FW Version)

The firmware version numbers are displayed on left side of screen. This information can be used to verify that the latest firmware is installed and is useful if a technical issue arises.

Further internal version numbers are displayed on right side of screen; Bundle, DSP, FPGA and Safe Image version.

Serial Number (Serial No.)

The printed serial number on the back panel of the PLM+ is also electronically embedded in the hardware, and therefore cannot be removed or altered if stolen.

Default Output Voltage (DefOutVolt)

Displays the default output voltage per channel that can exist across the PLM+'s output terminals. This is the absolute maximum, only the voltage defined by the ISVPL setting. The voltage can go higher with RPM; see the technical data sheet for actual maximum voltage.



Note: When Bridge Mode is activated, double the channel output voltage is available.

Max Output Current (MaxOutCurr)

Displays the maximum output current that can be delivered by the PLM+, summed across all output channels.

7.11.5.2. Frame Reset and Configuration

MENU > FRAME > RESET

Use this option to display a further menu with options to reset all parameters back to their original factory default values. See section 9.3 for a full list of the default factory reset parameter values. Two types of reset are provided: Factory Reset and Soft Reset.

Factory Reset

A Factory Reset will reset all settings and parameters to the original factory-defined default values. This includes the deletion of any Frame Presets stored within the device. It also resets the IP Address and all network related settings including the Dual Redundancy setting; a hard power cycle is required to complete this reset.

Soft Reset

A Soft Reset will reset all settings and parameters to the original factory-defined default values, but retains Frame Preset information and IP / Network configuration. A power cycle is not required to complete this type of reset.

7.11.5.3. Breaker Emulation Limiter

MENU > FRAME > BEL CONF

The Breaker Emulation Limiter (BEL) provides Ampere selection (5-32 A) and breaker type selection (CONSERVATIVE, FAST and UNIVERSAL). Select by pressing the adjacent button then use the rotary encoder to change the parameter.

The maximum RMS input current varies, and therefore a desired value is configured and the actual value is displayed within brackets.

7.11.5.4. Network

MENU > FRAME > NETWORK

Pressing the NETWORK button displays a further screen containing network configuration information. All parameters (except Redundancy) are view-only on the front panel and are either not editable, or can only be adjusted via the Lake Controller.

A summary at the top right of the screen confirms whether a valid connection is present for both Ethernet ports, and whether the Lake Controller is online.

- IP Addr: Displays the Internet Protocol address for the selected unit and can only be changed via the Lake Controller software. Please refer to the Lake Controller Operation Manual for further details.
- MAC: Displays the unique Media Access Control Ethernet address for the processor. This value cannot be changed.
- Frame ID: Displays the Frame ID, a unique Lake product identifier that cannot be changed.
- Primary and Secondary network connection status as well as Lake Controller connection status
- Mask: Displays the IP address subnet mask for the selected unit and can only be changed via the Lake Controller software. Please refer to the Lake Controller Operation Manual for further details.
- IP Config: Displays the IP configuration of the device (Auto - Zero Conf, Auto - DHCP or Fixed IP)
- Redundancy: Displays the dual redundancy status for the Frame (ON/OFF) This mode can be changed by pressing the adjacent button and confirming on the following dialog screen. Changing redundancy mode requires a power cycle to activate.

7.11.5.5. Latency Match

To turn Latency Match on or off, select the parameter using the adjacent button then change the status using the rotary encoder.

By default, PLM+ products exhibit the exact same input-to-output latency as the PLM and D Series products. However, the PLM+, PLM and D Series products have a greater latency compared to the Lake processors of LM Series. By enabling the Latency Match feature, the LM Series will add delay to match overall processing delay of the PLM, PLM+, and D Series. This regards Analog and AES only. Dante is not part of Latency match.

Exception: Latency match will not function correctly when running 48k based AES input using the primary clock domain.

7.11.6. Front Panel Display Controls

MENU > FRAME > FRONT

Contrast

To adjust the front panel LCD contrast, select this option then use the rotary encoder to change the value.

Dimming

To adjust the front panel LCD & LED brightness, select this option then use the rotary encoder to change the value.

Channel Order

To adjust the order in which both inputs and outputs are displayed on the front panel in all views, select this option then use the rotary encoder to change the value between TOP-DOWN (default) and BOTTOM-UP.

7.11.7. Frame Preset Menu

MENU > FRAME PRST

To recall an existing Frame Preset, use the rotary encoder to select the required Preset then press the RECALL button to overwrite the current configuration.



Note: Frame Presets must initially be created in the Lake Controller, and stored as a Preset using the Lake Controller or the PLM+ Series Preset Manager.

Up to 100 Frame Presets can be stored in the device. The data within a Frame Preset includes the configuration of all Modules in the Frame including levels, crossovers, EQ, input mixer, and output routing. (Note that Network settings and the Dual Redundancy setting are not part of Frame Presets.)

As Frame Presets are stored within the device, complete processor configurations can be recalled without connecting the device to a PC.

7.11.8. Load Monitor Menu (LoadSmart)

MENU > LOAD MON



Figure 7.22: LoadSmart Verification Results Screen

7.11.8.1. Configure # of Cabinets in Parallel

This option allows selection of the number of speaker cabinets connected to each PLM+ output channel. Select individual or multiple outputs and use the rotary encoder to set the value from 1 to 4. This value is used by LoadSmart to confirm the correct connection and status of the speakers connected to each PLM+ channel.

7.11.8.2. LoadSmart Verification

Select this option to initiate LoadSmart verification, then select YES to continue. LoadSmart performs a rapid test of all output channels, and displays the results on the LCD a few seconds later.



Figure 7.23: LoadSmart Verification Results Screen

The Load Results page provides three items of information per output channel:

- Confirmation that the speaker connected matches the speaker fingerprint assigned to the channel. If no Fingerprint is assigned, NO MODEL will be displayed. If the wrong speaker is connected; “Wrong Speaker” will be displayed
- Result of speaker cabinet count; this will either be OK or WRONG.
- Estimated number of speakers connected to the channel.

8. Back Panel Interface

An overview of the back panel interface is provided in section 4.2. This chapter describes each cluster of connections as shown in Figure 8.1.

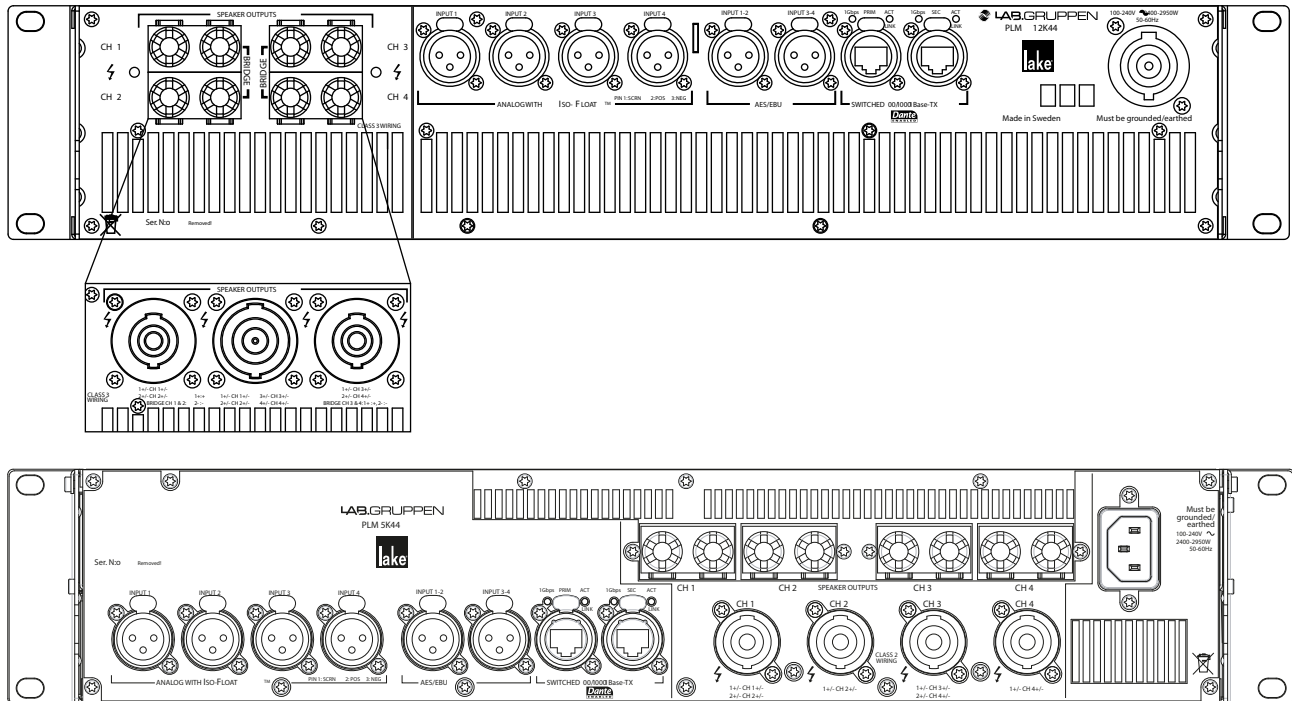

Figure 8.1: Back Panel Interface

8.1. Speaker Outputs

The PLM+ is available with either 4 mm binding posts or Neutrik speakON connectors for the outputs.

The outputs of the PLM+ can produce a high voltage. Do not connect or disconnect loudspeaker/s while the PLM+ is powered on. Never operate the PLM+ with any portion of bare loudspeaker wire exposed.

For speakON connector versions, do not use mating plugs without the rear covers in place.

8.1.1. Bridge Mode

Power outputs may be bridged on PLM 12K44 and 20K44 models by following the configuration instruction in the Lake Controller Operation Manual (I/O CONFIG > OUTPUT CONFIGURATION) and the wiring instructions in this chapter. Bridge Mode can only be activated/deactivated using the Lake Controller software.



NOTE: When Bridge Mode is activated, CLASS 3 wiring is required.

8.1.2. speakON Connectors

Power outputs are available simultaneously on a single 8-pole connector (PLM 20K44 and PLM 12K44 only) and on two 4-pole connectors. The four-pole connectors carry outputs for channels 1&2 and 3&4 respectively. For PLM 5K44, connector 1 carries output channels 1 and 2, connector 2 carries channel 2, connector 3 carries channel 3 and 4, and connector 4 carries channel 4.

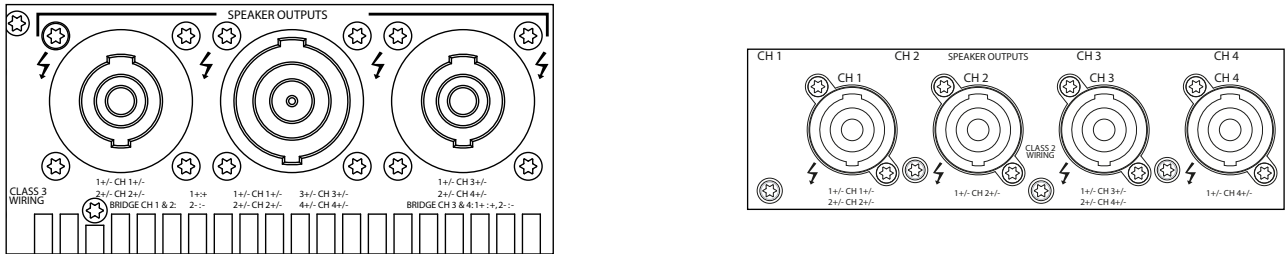

Figure 8.2: speakON Connections

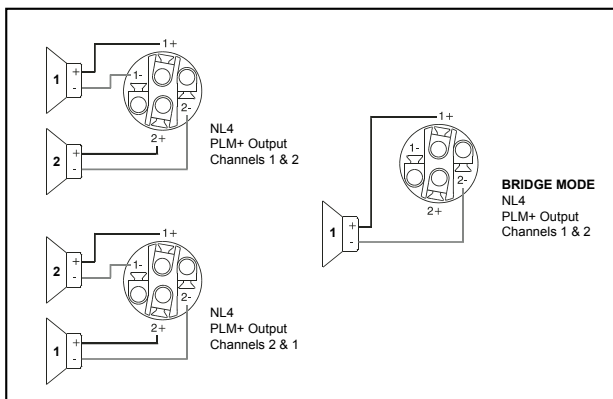
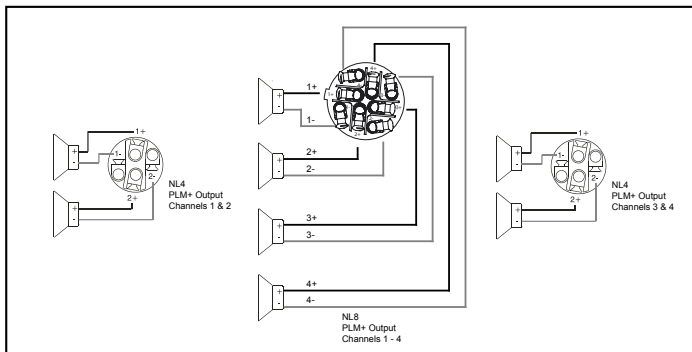

Figure 8.3: speakON wiring and pinouts (Bridge Mode)

PLM 12K44 and PLM 20K44



PLM 5K44

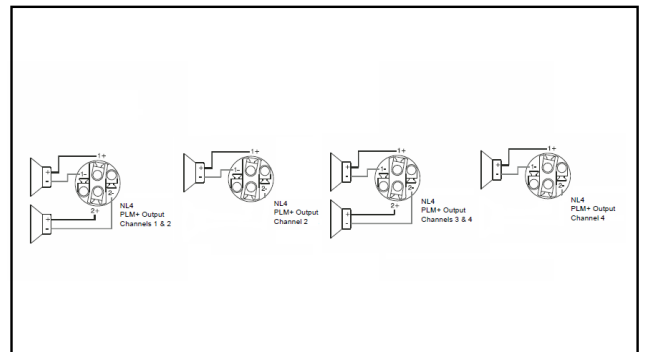

Figure 8.4: speakON NL4/NL8 Configuration

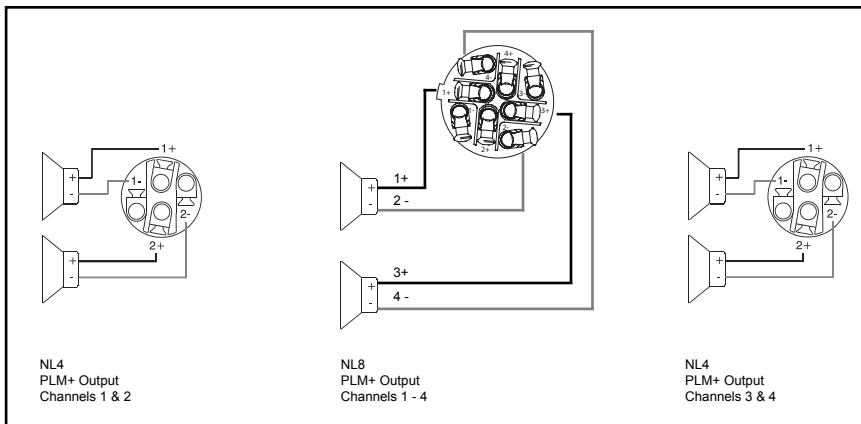

Figure 8.5: speakON NL4/NL8 Configuration

8.1.3. Binding Post Connectors

Binding post versions of the PLM+ are fitted with four pairs of black and red 4 mm binding posts.

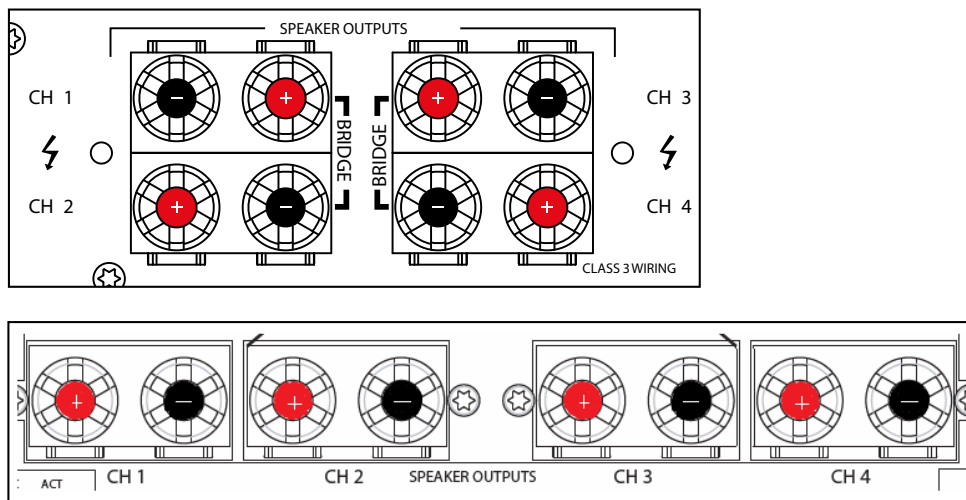

Figure 8.6: Binding Post Configuration

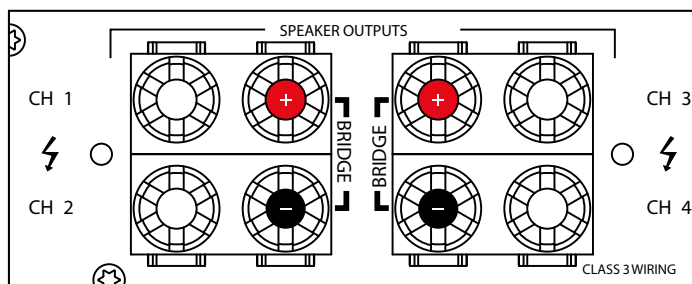

Figure 8.7: Binding Post Configuration (Bridge Mode)

8. Back Panel Interface

Connect the '+' loudspeaker terminals to the red binding posts and the '-' terminals to the black binding posts. There are three methods of connecting speaker cables to the binding posts.

1. Solder 4 mm banana-plugs to the ends of the speaker wires and plug into the center of the turrets.
2. Thread the stripped ends of the wires through the holes in the posts. Enter the wires for output channels 1 and 3 from above and for channels 2 and 4 from below. Tighten the plastic turrets by finger only, being careful not to overtighten.
3. Crimp 4 mm insulated spade terminals onto the ends of the wires and push into the binding post assembly from above (Ch. 1 & 3) or below (Ch. 2 & 4). The hole in the post is ignored. Hand tighten plastic turrets, being careful not to overtighten.

8.2. Analog Inputs

8.2.1. Analog Input XLR Connections

Four electronically balanced analog inputs are provided via latching XLR3F connectors.

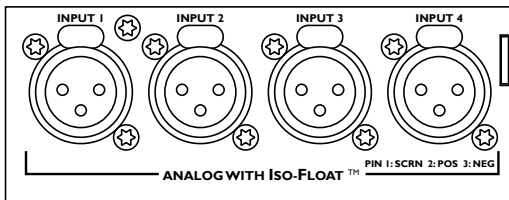

Figure 8.8: Analog Input XLR Connections

8.2.2. Analog & AES3 XLR Wiring and Pin Out

All XLR connections are wired to IEC268 as shown in Figure 8.9.

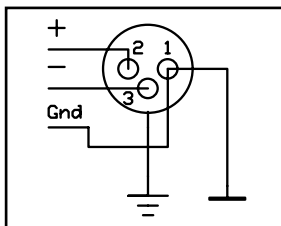

Figure 8.9: IEC268 XLR Wiring and Pin Out

Pin 1: Ground / Shield

Pin 2: Hot (+)

Pin 3: Cold (-)

8.2.3. Unbalanced Operation

Balanced connections are recommended where possible. However, if it is necessary to drive the device from equipment with an unbalanced output, wire the inputs as shown in Figure 8.10.

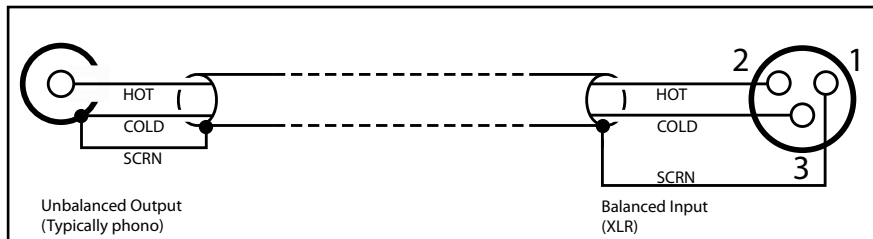

Figure 8.10: Balanced to Unbalanced Analog Wiring and Pin Out

The method shown in Figure 8.10 uses twin-and-screen (balanced) cable and standard XLR pin connections at the PLM+ Series device end, with the cold wire and the cable screen connected to the signal ground of the equipment at the source end.

This usually provides better noise and hum rejection than the more common method of joining pins 1 and 3 together in the XLR. However, if only a single-core (unbalanced) cable is available, the method shown in Figure 8.15 may be used.

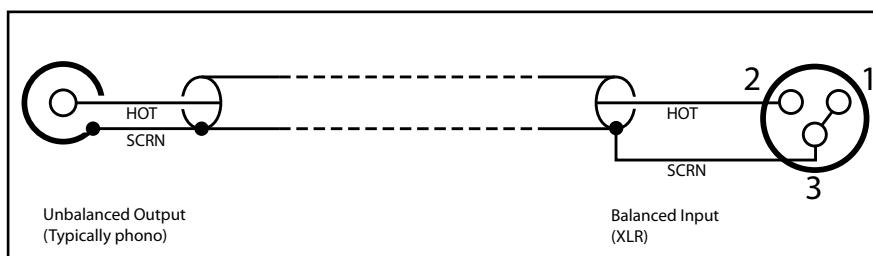

Figure 8.11: Unbalanced Analog Wiring and Pin Out

8.2.4. Iso-Float Electronic Balancing

The analog input electronic balancing circuits use the Lake Iso-Float system.

The Iso-Float technology combines the benefits of transformer-coupled isolation with the advantages of clean, direct-coupled inputs. The audio converters are galvanically isolated, and not connected to the main ground. High-quality transformers and opto-isolators create a barrier between the device and possible grounding aberrations from the outside electrical environment.

Iso-Float settings are adjustable via the front panel menu or the Lake Controller software.

8.3. AES3 Digital Inputs

8.3.1. AES3 XLR Connector

AES3 digital audio input is via two XLR3F connectors. Connectors are provided for Inputs 1 & 2 and Inputs 3 & 4. Wiring of this connector follows the same standard as for analog XLR connections as shown section 8.2.2.

The AES3 signal format carries two channels of audio and associated data on a single cable/connector. Selection of input channels is performed within the digital processing section of the PLM+ and is controlled from the menu system. Please refer to section 7.10.3.1 for further details.

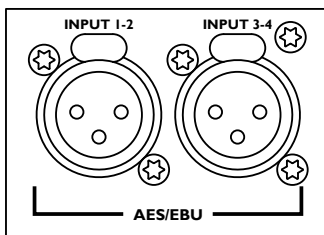

Figure 8.12: AES Inputs

8.4. RJ45 etherCON Network Connections

Two RJ45 etherCON style network connections are provided as shown in Figure 8.13.

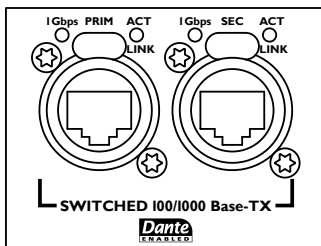

Figure 8.13: etherCON Network Connectors

The switched 100/1000 Base-T network connections auto-sense whether standard or crossover Cat-5e cables are in use. The green ACT LED illuminates (flashes) to show network activity, and when a 100 Mbps connection is present; the orange LED illuminates (static) to indicate a 1000 Mbps connection.

Pre-made cables with moulded RJ45 plugs are recommended. If it is necessary to make up custom Cat-5e network cables, use pinout described in Table 8.14.

Pin No.	Color
1	Brown
2	Brown + White
3	Green
4	Blue + White
5	Blue
6	Green + White
7	Orange
8	Orange + White

Table 8.14: RJ45 Wiring & Pin Out Description

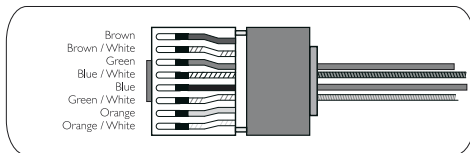

Figure 8.15: RJ45 Wiring & Pin Out Diagram

When the device is connected to an active network, the yellow LINK LED illuminates above the connector in use. Data activity on the network is indicated by illumination of the green ACT LED. It is normal for the ACT LED to flicker either sporadically or continuously.

8.4.1. Primary Network Connection

The Primary Network connection is used for Lake Controller connectivity, Dante and AES67 digital audio. Please refer to section 4.2 for additional information.

8.4.2. Secondary Network Connection

The Secondary Network connection may be used for a redundant Dante digital audio network. Please refer to section 4.2 for additional information.

8.5. Power Inlet

8.5.1 Power Connector

A Neutrik NAC3 Series powerCON connector rated at 32 A is fitted to the rear of the PLM+ for AC mains input. The power cable (AC cord) supplied with the PLM+ has the mating connector ready-fitted, but may require a mains (AC) plug specific to your country to be fitted to the other end. The wiring and pinout details are shown in Table 8.2.

powerCON pin	230 V Cable	115 V Cable
L	Brown	Black
N	Blue	White
	Green/Yellow	Green

Table 8.16: powerCON Connector Wiring and Pinout

9. Appendix

9.1. Faults and Warnings Overview

Category/Type	Name	On screen text	Description	Action
FRAME				
Warning	Lake Controller offline	CTRL OFFLINE	Frame unable to find Lake controller on the network	Check network cabling/ network if controller expected on the network
Warning	AES clock slipping	CLOCK SLIPPING	Frame not able to lock to incoming AES stream	Check AES sender and clock configuration
Warning	Dante device name conflict	NAME CONFLICT	Two or more devices on the network with the same Dante name	Review Dante configuration
Warning	Dante module not detected	DANTE NEEDS SERVICE	Lake cannot detect a functioning Dante module	Restart device; if not cleared it needs service to operate Dante
Warning	Dante module with incompatible firmware	DANTE FW INVALID	Dante module not loaded with correct FW	Retry updating the firmware with LakeUpdate
Warning	Audio Fault	AUDIO FAULT	Internal audio interface not functioning	Restart device; if not cleared it needs service
Warning	Sense fault DSP	SENS FLT:DSP	Voltage and current sensing on amplifier output faulty. Audio continues but protection might be compromised. No load monitoring	Restart device; if not cleared it needs service
Fault	A/D converter power supply fault	A/D PSU FAULT	Voltage supply to the analog input converters faulty	Restart device; if not cleared it needs service for analog input to work
TEMP				
Warning	Temperature warning power supply	TEMP WARN:PSU	Power supply temperature approaching critical levels	Improve cooling or reduce output power to avoid temperature becoming critical
Warning	Temperature warning DSP area	TEMP WARN:DSP	DSP area temperature approaching critical levels	Improve cooling or reduce output power to avoid temperature becoming critical
Warning	Power supply Temperature Limit	PTL ACTIVE	Amplifier is reducing output power to avoid power supply temp fault protection	Improve cooling or reduce output power to avoid limiting
Warning	Amp channel Temperature Limit	ATL ACTIVE	Amplifier channel is reducing output power to avoid amplifier channel temp fault protection	Improve cooling or reduce output power to avoid limiting
Fault	Temperature fault power supply	TEMP FLT:PSU	Power supply temperature reached internal protection limit	Automatically restarts when cooled down
Fault	Temperature fault DSP area	TEMP FLT:DSP	DSP area reached critical temperature	Improve cooling or reduce power

Category/Type	Name	On screen text	Description	Action
PSU				
Warning	Under Voltage Limit	UVL ACTIVE	The Under Voltage limiter is active as the mains supply is approaching the lower end of the device's operational voltage. Output power is decreased to ensure mains distribution does not collapse	Increase mains distribution stiffness or reduce output power to avoid limiting
Warning	Power Average Limit	PAL ACTIVE	Amplifier is reducing output power due to average power or mains current draw is above safe operating levels	Reduce output power to avoid limiting
Warning	Breaker Emulation Limit	BEL ACTIVE	Power supply is reducing mains current draw to stay within BEL configured nominal current and profile	Improve mains distribution and update BEL configuration or reduce output power to avoid limiting
Warning	Mains supply glitch	MAINS GLITCH	Mains glitch (missing cycles) was detected on the mains inlet	Check mains distribution/ connection
Fault	Need service	NEED SERVICE:1-8	Power supply internal error	Restart device; if not cleared it needs service
Fault	Mains voltage above 400 volt peak	MAINS>400 VPK	Power supply detects mains voltage above 400 volt peak. Protective shut down, auto restart attempt	Check mains distribution/ connection
Fault	Mains voltage above 270 V	MAINS>270 V	Power supply detects mains voltage above operation voltage. Protective shut down, auto restart attempt	Check mains distribution/ connection
Fault	Mains voltage below 65 V	Mains<65 V	Power supply detects mains voltage below operation voltage. Protective shut down, auto restart attempt	Check mains distribution/ connection
Fault	Power supply fault	PSU FAULT	Internal power supply fault	Check mains distribution/ connection. Restart device; if not cleared it needs service
Fault	Check mains	CHECK MAINS	Power supply detects unstable mains supply. Protective shut down, auto restart attempt	Check mains distribution/ connection
Fault	Power supply power protect	PSU POWER PROT	Too high output power for too low mains supply voltage. Protective shut down, auto restart attempt	Improve mains supply voltage or reduce output power
LOAD				
Warning	Speaker short	SPKR SHORT	Both LoadPilot tones below thresholds	Check load or calibration
Warning	Speaker damaged	SPKR DAMAGED	One LoadPilot tone is above or below threshold	Check load or calibration
Warning	Under speaker count	UNDER SPKR CNT	Both LoadPilot tones above thresholds or LoadSmart detected fewer speakers than expected	Check load and cabling alibration

Category/Type	Name	On screen text	Description	Action
Warning	More speakers	OVR SPKR COUNT	LoadSmart detected more speakers than expected	Check load and cabling or fingerprint
Warning	Uncertain about load	UNCERTAIN LOAD	LoadSmart uncertain about load	Check load and cabling or fingerprint
Warning	Load not verified	LOAD NOT VER	LoadSmart not verified	Perform LoadSmart verification
Fault	No load	NO LOAD	At least one LoadPilot tone above measurable area or significantly above thresholds	Check load or calibration
Fault	Wrong load	WRONG LOAD	LoadSmart detected impedance response output model	Check load and cabling or fingerprint
Fault	Short circuit	SHORT CIRCUIT	LoadPilot or full frequency analysis below short threshold or hardware short protection	Check load and cabling
AMP				
Warning	Temp warning amplifier channel	TEMP WARN	Amplifier channel is approaching critical temperature	Improve cooling or reduce output power to avoid temperature becoming critical
Fault	Temp Fault amplifier channel	TEMP FAULT	Amplifier channel has reached internal protection limit	Automatically unmutes when cooled down
Fault	Service channel	SERVICE CH.	Amplifier channel is damaged	Restart device; if not cleared it needs service
Fault	Very high frequency fault	VHF FAULT	Amplifier channel protection	Check input signal or reduce output. With a maximum of -12 dB of gain reduction in the VHF warning, VHF Fault will trigger after 15 seconds
Warning	Very high frequency warning	VHF WARNING (PLM20K/12K44 only)	Amplifier channel gain reduction due to VHF content	Check input signal
Clip	Current average limiter	CAL ACTIVE	Average current on amplifier above safe operating level	Reduce output power to avoid limiting
Clip	Current clip	CURRENT CLIP	Amplifier channel reached current limit	Reduce output power to avoid limiting
Clip	Voltage clip	VOLTAGE CLIP	Amplifier reached voltage limit	Reduce output power to avoid limiting
Clip	Module clip	MOD. CLIP	Module output signal clipped	Review gain structure. Module gain vs AmpGain
SIGNAL				
Fault	No input source	NO INPUT	Input router has no valid input source	Review input router settings/connections
Clip	Analog/AES input clip	INPUT CLIP	The signal on the analog/AES input is above inputs capability	Lower the signal on the feed to the amplifier

Table 9.1: Warning, Fault and Mute Indications (alphabetical by LCD Text / Event Log Text)

9.2. Maintenance

During normal operation this devices provides trouble-free service. If the LCD or front panel display requires cleaning, use a soft cloth only; do not use solvent cleaners. The dust filters on both sides of the front panel, behind the grilles, should occasionally be removed and cleaned to ensure maximum airflow through the device.

Disconnect the unit from mains power prior to removing dust the filter, and ensure the dust filter is replace prior to turning the unit back on.

Do not use sharp or metal objects to remove the dust filter, and be careful that the implement used to remove the filter does not enter the device.

In extreme cases it may be necessary to clean the inside of the device. This procedure should only be carried out by qualified service personnel. This may be necessary if the device has had prolonged operation in an extreme environment such as one where cracked oil smoke machines are in use. If the device is used in extreme conditions, it is recommended to have it serviced every three years as a preventative measure.

9.3. Factory Default Settings

9.3.1. Module Defaults

Module Type:	4 x CL1-Way	
Mod Input Mute:	On	
Mod Output Mutes:	Off	
Gain:	0 dB (unity)	
Delay:	0 ms	
Polarity:	Positive (In phase)	
MaxRMS:	20 dB	
MaxPeak:	21 dB	
Amp Gain:	35 dB	
ISVPL:	20K44	194 V
	12K44	175 V
	5K44	147 V
Input & Output EQ:	Flat	

9.3.2. Input and Router Defaults

Autoselect: On
 Input sensitivity: +26 dBu
 Dante: Disabled
 AES3: Terminated
 Iso-Float: Enabled

Router 1: Priority 1 = Dante Receiver (Ch.1)
 Priority 2 = Dante Receiver (Ch.5)
 Priority 3 = AES1 (Ch.1)
 Priority 4 = Analog 1

Router 2: Priority 1 = Dante Receiver (Ch.2)
 Priority 2 = Dante Receiver (Ch.6)
 Priority 3 = AES1 (Ch.2)
 Priority 4 = Analog 2

Router 3: Priority 1 = Dante Receiver (Ch.3)
 Priority 2 = Dante Receiver (Ch.7)
 Priority 3 = AES1 (Ch.3)
 Priority 4 = Analog 3

Router 4: Priority 1 = Dante Receiver (Ch.4)
 Priority 2 = Dante Receiver (Ch.8)
 Priority 3 = AES1 (Ch.4)
 Priority 4 = Analog 4

9.3.3. Amplifier and Device Defaults

Attenuation: 0 dB
 Polarity: Positive (In phase)
 Mutes: Unmuted
 Load Model: No Load Model
 Breaker Emulation Limiter: 20K44 - 32A
 12K44 - 25A
 5K44 - 15A
 IP Configuration: Auto Zero Conf. (Auto IP)
 Dual Redundancy: Disabled
 Dante Slave Only: Enabled

9.4. Current Draw and Thermal Dissipation Specifications

The tables in this section provide measured current consumption and calculated heat dissipation for five different operating conditions for each PLM+ Series device.

1. Standby Mode
2. Power On (Idle - No Signal)
3. Power On (Normal Operation - Pink Noise 1/8 of Rated Power)
4. Power On (Heavy Duty Operation - Pink Noise Max Power)
5. Power On (Pilot Tone Operation - 20 kHz Sine Wave)

PLM5K44								
Level	Load	Rated power per channel	Line Current (A)	Measured Power (W)			Thermal Dissipation	
				In	Out	Dissipated	BTU/hr	kCal/hr
Mains Voltage 100 VAC								
Standby			0.2	7	0	7	24	6
Power on, Idling, Green Mode			0.6	59	0	59	201	51
Power on, Idling, Performance Mode			0.8	78	0	78	267	67
Pink Pseudo Noise	16 Ω/ Ch.	700 x 4	5.1	501	350	151	515	130
	8 Ω/ Ch.	1250 x 4	8.9	881	625	256	872	220
	4 Ω/ Ch.	1250 x 4	9.3	915	625	290	990	249
	2 Ω/ Ch.	900 x 4	7.8	771	450	321	1097	276
	100V/ Ch.	1250 x 4	8.9	880	625	255	870	219
70V/ Ch.	1250 x 4	10.0	982	650	332	1133	285	
Mains Voltage 120 VAC								
Standby			0.3	7	0	7	24	6
Power on, Idling, Green Mode			0.5	59	0	59	200	50
Power on, Idling, Performance Mode			0.7	77	0	77	263	66
Pink Pseudo Noise	16 Ω/ Ch.	700 x 4	4.2	498	350	148	506	127
	8 Ω/ Ch.	1250 x 4	7.3	856	625	231	788	199
	4 Ω/ Ch.	1250 x 4	7.7	909	625	284	969	244
	2 Ω/ Ch.	900 x 4	6.4	751	450	301	1027	259
	100V/ Ch.	1250 x 4	7.3	857	625	232	793	200
70V/ Ch.	1250 x 4	8.0	949	650	299	1019	257	
Mains Voltage 208 VAC								
Standby			0.3	7	0	7	25	6
Power on, Idling, Green Mode			0.5	58	0	58	198	50
Power on, Idling, Performance Mode			0.5	77	0	77	263	66
Pink Pseudo Noise	16 Ω/ Ch.	700 x 4	2.4	481	350	131	447	113
	8 Ω/ Ch.	1250 x 4	4.1	831	625	206	703	177
	4 Ω/ Ch.	1250 x 4	4.4	883	625	258	881	222
	2 Ω/ Ch.	900 x 4	3.7	734	450	284	969	244
	100V/ Ch.	1250 x 4	4.1	832	625	207	707	178
70V/ Ch.	1250 x 4	4.6	920	650	270	922	232	
Mains Voltage 230 VAC								
Standby			0.3	7	0	7	25	6
Power on, Idling, Green Mode			0.4	58	0	58	197	50
Power on, Idling, Performance Mode			0.5	77	0	77	263	66
Pink Pseudo Noise	16 Ω/ Ch.	700 x 4	2.2	474	350	124	435	109
	8 Ω/ Ch.	1250 x 4	3.7	817	625	192	625	165
	4 Ω/ Ch.	1250 x 4	3.9	869	625	244	833	210
	2 Ω/ Ch.	900 x 4	3.3	724	450	274	936	236
	100V/ Ch.	1250 x 4	3.7	822	625	197	544	137
70V/ Ch.	1250 x 4	4.1	908	650	258	881	222	

Table 9.2: PLM5K44 Current Draw and Dissipation Specifications

PLM12K44									
Level	Load	Rated power per channel	Line Current	Power Factor	Measured Power (W)			Thermal Dissipation	
					(A)	(%)	In	Out	Dissipated
Mains Voltage 100 VAC, 30 A									
Standby			0.3	43	12	0	12	40	10
Power on, Idling			2.3	98	219	0	219	749	189
Pink Pseudo Noise	16 Ω / Ch.	950	10.8	99	1059	475	584	1994	503
	8 Ω / Ch.	1900	19.2	99	1868	949	919	3136	791
	4 Ω / Ch.	3000	24.6	99	2389	1200	1189	4057	1023
	2.67 Ω / Ch.	3000	25.7	99	2551	1151	1400	4776	1204
	2 Ω / Ch.	3000	25.8	99	2576	1113	1463	4992	1259
LoadPilot Sine 20 kHz	8 Ω / Ch.		2.4	98	231	0	231	789	199
Mains Voltage 120 VAC, 30 A									
Standby			0.3	36	11	0	11	39	10
Power on, Idling			1.9	98	215	0	215	734	185
Pink Pseudo Noise	16 Ω / Ch.	950	8.8	99	1035	475	560	1910	482
	8 Ω / Ch.	1900	15.1	99	1765	949	815	2783	702
	4 Ω / Ch.	3000	24.0	99	2817	1502	1315	4487	1131
	2.67 Ω / Ch.	3000	24.5	99	2894	1437	1456	4969	1253
	2 Ω / Ch.	3000	25.1	99	2980	1361	1619	5524	1393
LoadPilot Sine 20 kHz	8 Ω / Ch.		2.0	97	226	0	226	773	195
Mains Voltage 208 VAC, 17.3 A									
Standby			0.3	18	12	0	12	42	11
Power on, Idling			1.1	91	211	0	211	720	182
Pink Pseudo Noise	16 Ω / Ch.	950	4.9	99	1001	475	526	1795	453
	8 Ω / Ch.	1900	8.7	99	1766	949	816	2786	702
	4 Ω / Ch.	3000	13.3	99	2687	1501	1186	4046	1020
	2.67 Ω / Ch.	3000	14.0	99	2847	1500	1346	4594	1158
	2 Ω / Ch.	3000	14.8	99	3046	1500	1546	5276	1330
LoadPilot Sine 20 kHz	8 Ω / Ch.		1.2	93	221	0	221	754	190
Mains Voltage 230 VAC, 16 A									
Standby			0.3	18	12	0	12	42	11
Power on, Idling			1.1	91	211	0	211	720	182
Pink Pseudo Noise	16 Ω / Ch.	950	4.9	99	1001	475	526	1795	453
	8 Ω / Ch.	1900	8.7	99	1766	949	816	2786	702
	4 Ω / Ch.	3000	13.3	99	2687	1501	1186	4046	1020
	2.67 Ω / Ch.	3000	14.0	99	2847	1500	1346	4594	1158
	2 Ω / Ch.	3000	14.8	99	3046	1500	1546	5276	1330
LoadPilot Sine 20 kHz	8 Ω / Ch.		1.2	93	221	0	221	754	190

Table 9.3: PLM12K44 Current Draw and Dissipation Specifications

PLM20K44									
Level	Load	Rated power per channel	Line Current	Power Factor	Measured Power (W)			Thermal Dissipation	
			(A)	(%)	In	Out	Dissipated	BTU/hr	kCal/hr
Mains Voltage 100 VAC, 30 A									
Standby			0.3	52	17	0	17	58	15
Power on, Idling			2.4	97	235	0	235	802	202
Pink Pseudo Noise	16 Ω / Ch.	1150	12.1	99	1192	588	604	2061	520
	8 Ω / Ch.	2300	22.3	99	2198	1174	1024	3493	881
	4 Ω / Ch.	4400	29.2	99	2853	1478	1375	4691	1183
	2.67 Ω / Ch.	5000	29.2	99	2862	1399	1463	4991	1259
	2 Ω / Ch.	4400	29.1	99	2826	1355	1472	5022	1266
LoadPilot Sine 20 kHz	8 Ω / Ch.		2.5	97	236	0	236	807	203
Mains Voltage 120 VAC, 30 A									
Standby			0.3	48	17	0	17	58	15
Power on, Idling			2.0	97	227	0	227	775	195
Pink Pseudo Noise	16 Ω / Ch.	1150	12.0	99	1180	588	593	2023	510
	8 Ω / Ch.	2300	18.4	99	2144	1174	970	3310	835
	4 Ω / Ch.	4400	30.0	99	3457	1896	1561	5326	1343
	2.67 Ω / Ch.	5000	29.5	99	3439	1752	1687	5756	1451
	2 Ω / Ch.	4400	29.9	99	3495	1665	1830	6245	1575
LoadPilot Sine 20 kHz	8 Ω / Ch.		2.0	97	232	0	232	790	199
Mains Voltage 208 VAC, 17.3 A									
Standby			0.3	27	18	0	18	60	15
Power on, Idling			1.2	92	222	0	222	757	191
Pink Pseudo Noise	16 Ω / Ch.	1150	5.7	99	1151	588	564	1923	485
	8 Ω / Ch.	2300	10.2	99	2055	1174	881	3005	758
	4 Ω / Ch.	4400	16.2	99	3286	1948	1338	4565	1151
	2.67 Ω / Ch.	5000	15.6	99	3171	1752	1419	4843	1221
	2 Ω / Ch.	4400	16.0	99	3253	1665	1589	5420	1367
LoadPilot Sine 20 kHz	8 Ω / Ch.		1.2	92	229	0	229	780	197
Mains Voltage 230 VAC, 16 A									
Standby			0.3	23	18	0	18	61	15
Power on, Idling			1.2	92	222	0	222	757	191
Pink Pseudo Noise	16 Ω / Ch.	1150	5.1	98	1134	588	546	1863	470
	8 Ω / Ch.	2300	9.2	99	2053	1174	879	2999	756
	4 Ω / Ch.	4400	15.9	99	3529	2109	1420	4845	1222
	2.67 Ω / Ch.	5000	16.0	99	3564	1935	1630	5561	1402
	2 Ω / Ch.	4400	16.0	99	3577	1856	1722	5875	1481
LoadPilot Sine 20 kHz	8 Ω / Ch.		1.1	90	228	0	228	777	196

Table 9.4: PLM20K44 Current Draw and Dissipation Specifications

9.5. Glossary of Terms, Acronyms and Abbreviations

The explanations given in Table 9.5 below are based on the specific use of each term in this manual. The definitions are not intended to be exhaustive and many of these terms have wider meanings.

Term	Description
Floating	An analog balanced input or output is said to be floating when full electrical isolation exists between that input or output and the equipment connected to it. Transformer-coupled inputs and outputs are inherently floating. Electronically balanced inputs and outputs can never be truly floating, though better designs – such as that found in the PLM+ – do mimic the characteristics of transformer-coupled designs to a high degree.
Frame	Lake terminology for a physical unit containing a Lake processing system, i.e. a single LM 26, PLM, PLM+ or legacy Lake Processor.
Frame ID	An electronic identification 'label' which can be given to each Frame in an amplification system. Naming Frames in a large system is desirable as it simplifies identification in the Lake Controller.
Frame Preset	Frame Presets are a class of Presets within the Lake processing system. Up to 100 can be stored in the hardware device, and each holds the complete configuration of all Modules and the Modules' internal settings.
Gigabit Ethernet	Describes the speed of Ethernet data transfer for devices that transmit Ethernet frames at a rate of a gigabit per second, as defined by the IEEE 802.3-2008 standard.
Hub	A type of network interface device with multiple Ethernet ports. Data arriving at any port is sent to all others. Hubs have been largely replaced by Switches.
In-Rush Current	When power is applied to a piece of electronic equipment, the initial current taken by the PSU can be very high as the various capacitors in the circuitry charge up; this is called the in-rush current. In the case of power amplifiers, which contain numerous very large capacitors, the in-rush current can be enough to blow mains breakers. The PLM+'s PSU contains circuitry to control the in-rush current to prevent this.
Input Level	The amplitude of an audio signal at the point where it is applied to the input of the device, or at the input of an intermediate stage within it. An analog input signal level will be expressed in dBu's, while a digital input signal level in dBFS (dBs below digital clip level; FS = full-scale)
IP Address	Every item of equipment connected to an Ethernet network has a unique address called the IP address, so that data gets to the correct place. IP addresses are written as four groups of three decimal numbers between 0 and 255. In a system consisting of Lake Processors and a Lake Controller they are assigned and detected automatically.
IP Subnet Mask	IP subnet masks are required in all IP networks. The subnet is determined by the size and type of network being used. For small networks (less than 254 addresses) a subnet mask of 255.255.255.0 can be used. (A Class C network).
Iso-Float	Iso-Float is Lake's proprietary method of electronic balancing, which provides a particularly high level of isolation and immunity from ground loops.
ISVPL	ISVPL is an abbreviation for Inter-Sample Voltage Peak Limiter, a proprietary Lab.gruppen technique for ensuring that voltage at the output terminals of a PLM+ does not exceed a pre-determined level. Eight ISVPL profiles provide the ability to configure for low distortion or high SPL specific to certain frequency ranges, or for universal use.
Lake Controller	The Lake Controller is the software application used to control LM 26 Processors, PLM+ Series and other Lake devices. This software application provides additional functionality and allows various grouping functions for simultaneous control of multiple Lake Processing enabled devices.
Latency	The small but finite delay incurred by audio signals when they are transformed into the digital domain, processed digitally and then converted back into analog signals. In the Lake system, latency is assured to be constant.
Legacy Lake Device	This term refers to older Lake audio equipment which may form part of an audio system (i.e. Lake Contour Pro 26, Lake Mesa Quad EQ and the Dolby Lake Processor). The Lake Controller has the capability to control all Lake legacy products.
LimiterMax	LimiterMax is the name given to Lake's proprietary package of dynamics control which forms part of the Lake Processing system.
Line Driver	An analog audio amplifier, usually with zero gain, having very low output impedance and high drive capability. They are used for transmitting balanced analog audio over very long cables.
Linear Phase Crossover	See FIR Filters.
Load Library	The Lake Controller includes LoadLibrary, a set of Module files specific to the PLM+ Series. These Modules include a database of the electrical characteristics of various popular loudspeakers in addition to the standard Module data. The PLM+ uses the load data when verifying and monitoring amplifier loads. See Fingerprint, LoadSmart and SpeakerSafe.
Load, equal/unequal	The PLM+ draws different current levels from the AC supply, and thus has different power ratings according to whether all channels of the amplifier are driving into the same load impedance, or if there are different impedances on different channels.
LoadSmart	LoadSmart is a load verification procedure within the PLM+ which allows the operator to confirm that each PLM+ output has the correct quantity and type of speaker connected to it. It is intended to be used pre-performance prior to running SpeakerSafe.
Loop-Thru	This term refers to the Link connectors provided on the PLM+ for daisy-chaining further amplifiers or other equipment. The use of these to connect further devices is termed a loop-thru.
MAC Address	In addition to an IP address, every device on an Ethernet network has a MAC address. This address is fixed at the time of manufacture, and is effectively the permanent identifier of the physical unit. MAC stands for Media Access Control
MaxPeak	Lake's LimiterMax provides independent dynamics control over signal peaks (MaxPeak) and the average signal level (MaxRMS).
Module	The term used in the Lake Controller to describe the virtual set of signal processing that routes an audio input to the various frequency weighted outputs of a crossover. The processing system within the device allows for two Modules, each of which may be assigned a range of crossover configurations, input sources, etc.
Module Preset	A class of Preset within the Lake processing system. A Module Preset (Module file) contains all the configuration data and settings for one Module, and is saved in the Lake Controller software, not in the hardware device.

Term	Description
Offline	A device on an Ethernet network which is not communicating with the rest of the network either due to a fault or intentionally is said to be offline.
Online	A device on an Ethernet network which is fully operational and communicating with the rest of the network is said to be online.
PAL	An abbreviation for Power Average Limiter, PAL is proprietary Lab.gruppen circuit which provides additional amplifier protection. The PAL ensures that the power drawn by the PSU from the AC mains does not exceed the mains breaker ratings.
Parallel	Two or more e.g. inputs which are wired together so that all inputs are connected to the same source are said to be paralleled. Signal levels will be reduced if too many inputs are paralleled; in the case of AES3, this may result in a complete loss of audio.
Parameter	Any control function which can be adjusted by the user to one of several different values is termed a parameter. For example, input level, gain, delay, and limiter threshold are all parameters.
Pass-Through Cable	See Straight network cable.
PFC	Power Factor Correction. PFC reduces current peaks on the lines and reduces the requirements placed on the mains distribution system.
Ping	Ping is a term coined by the IT industry to the procedure of sending a command over a network to a particular Ethernet device asking it to confirm its identity and possibly reply with additional information. Thus an Lake device on the network can be pinged from the Lake Controller; on receipt of the 'ping', the hi-intensity white LED on the front panel illuminates. Reverse ping is also possible, whereby the ping is instigated from Lake hardware device and a visual identification of the processor registers in the Lake Controller software.
Preset	A complete frame configuration that is stored in the device hardware.
Primary Ethernet Port	The Primary Ethernet port on the is the means of connecting the device to a network. See also Secondary Ethernet Port.
PSU	Abbreviation of Power Supply Unit. The PSU in any item of electronic equipment converts the AC mains into a set of internal DC voltages which run the electronic assemblies themselves.
RJ45	RJ45 connections are the industry-standard connectors for Ethernet ports.
Router	As far as networks of the type discussed in this manual are concerned, see Switch.
Secondary Ethernet Port	The Secondary Ethernet port can be used either as a daisy-chain output, repeating the network connection at the Primary port, or for the connection of a separate second network for full redundancy.
Short Circuit Protection	A Lab.gruppen proprietary protective circuit designed to mute a channel when a short circuit is detected at its output terminals to prevent damage to the device.
SpeakerSafe	Once activated, SpeakerSafe constantly monitors the voltage and current at the PLM+'s outputs. Using Fingerprint data, the software then calculates parameters such as voice coil and magnet temperatures, providing the operator with real-time performance monitoring. See LoadLibrary.
speakON	An industrial-quality loudspeaker connector manufactured by Neutrik. 4-pole (2 speakers) and 8-pole (4 speakers) versions are fitted to various versions of the PLM+.
Star Topology	A network topology which uses a network switch to connect to individual Lake devices. Each device connects to one port on the switch with its own cable, thus the network looks like a star when drawn as a diagram with the switch at the centre.
Straight Network Cable	A Cat-5/6 network cable with full pin-to-pin connections is called a straight network cable. Lake devices can connect to a network using either straight or crossed network cables.
Subsystem	It is possible when working with large networked systems to store selected components of the system into a Subsystem. This is useful if working on a tour that encompasses both large and mid-sized venues. The same core Lake Controller data can then be used for a reduced number of Lake devices.
Super Module	A Super Module is a virtual construct that can be realized within the Lake Controller, allowing a set of Modules in different Frames to be treated as a single Module.
Switch (Ethernet)	An Ethernet switch allows several Ethernet devices to be connected to a network using a star topology. More intelligent than the earlier hubs which they now largely replace, they route packets of data only to the units for which they are intended, and also perform other system housekeeping and control functions.
System Preset	A class of Preset within the Lake Processing system, System Presets allow Module or Frame configurations and settings to be stored for the entire network of LM 26 Processors, PLM Series, PLM+ Series and other legacy Lake devices.
Tablet PC	A compact PC which uses a touchscreen instead of keyboard and mouse. The Lake Controller has been optimized for use on Tablet PCs.
Termination	AES3 digital audio interconnections must be correctly terminated for reliable operation. The 110 ohm terminations must be set 'on' at the beginning and end of a set of daisy-chained digital audio equipment, and 'off' at any intermediate ones.
Topology	A mathematical word for "arrangement" or "configuration". The topology of a network is a means of visualizing the overall configuration of the network.
Universal Power Supply	A power supply that operates in all countries, without the need for manual adjustment, as long as the voltage falls within the specified range for the device.
VHF Protection	VHF protection is another amplifier safety circuit developed by Lab.gruppen. The presence of continuous HF audio can easily damage loudspeakers, so the protection circuit monitors the output this, muting the power output channel if necessary
V peak	Indicates the peak voltage of an audio signal. For a sinusoidal signal, the peak voltage = 1.414 x the RMS voltage, Vrms. Not to be confused with peak-to-peak voltage (written V pk-pk), which = V peak x 2.
Vrms	The RMS voltage of a signal. See RMS.
Wireless Access Point	A device used to connect a computer to an Ethernet network without cables; a radio transmitter/receiver for data.
Wireless Network	An Ethernet network where some or all cabled connections are replaced by wireless links.

Table 9.5: Glossary of Terms, Acronyms and Abbreviations

10. Application Guide

This chapter describes the practical application and use of PLM+ Series devices.

10.1. Rack I/O Panels

For fast and simple system connection, pre-wired racks using connection panels can be used. With an I/O connector panel fitted to the front of the rack, all audio, loudspeaker, network and power cables can be plugged in at one position, without requiring rear panel access.

10.2. Gain Structure

The PLM+ Series architecture provides gain adjustments at various points in the signal path for enabling muting and level adjustment. Each mute or gain adjustment point serves a different purpose. The signal flow diagrams in chapter 6 provide a useful reference for the signal path. The following sections describe the various adjustment points, all of which are available via the Lake Controller software.

10.2.1. Input Headroom (Analog Inputs Only)

Input Headroom should be set to 12 dBu if the source can be limited to 12 dBu; otherwise it should be set to 26 dBu. This setting does not affect the other gain stages, or the overall noise floor; it allows control of the appropriate headroom at the input stage only.

To adjust, navigate to I/O CONFIG > INPUT CONFIGURATION in the Lake Controller. Please refer to the Lake Controller Operation Manual for further details.

10.2.2. Input Mixer

Input Mixer gains can remain at 0.00 dB for most configurations; if only one input channel is used per Module, the other can be set to -INF.

To adjust, navigate to I/O CONFIG and tap the Input Mixer blocks for the Module in the Lake Controller. Please refer to the Lake Controller Operation Manual for further details.

10.2.3. Module Input Gain

Input Gain is used to adjust the level between different speaker cabinets in the system. This gain can remain at 0.00 dB unless a lower level is required for the cabinet/s driven by this Module.

To adjust, navigate to MODULES > EQ/LEVELS > LEVELS in the Lake Controller. Please refer to the Lake Controller Operation Manual for further details.

10.2.4. Module Output Gain

Factory and User Gain are provided for each Module output. These two stages provide a level of security and control for the system designer (Factory) and a further level of adjustment for the user (User), both of which combine to balance the level between frequency bands in a multi-way crossover (Contour configuration) or the Module output level (Mesa configuration).

1. Factory Gain is set by the system designer and can be hidden within the Module file. The Factory Gain parameter is only accessible when the Module is unlocked and the Lake Controller is in Designer Mode. Adjust via **MODULES > LEVELS > METER OPTIONS > ADJUST FACTORY**.
2. User Gain is editable by a user unless the system designer has locked away the parameter; adjust via **MODULES > LEVELS**.

Generally, output gain values are configured within a Module / loudspeaker preset file and should not need to be adjusted further.

10.2.5. Attenuator

An attenuator gain adjustment is provided for each power output channel in the PLM+. This control replaces the traditional volume control found on conventional amplifiers and should typically be left at 0 dB during use.

To adjust, navigate to **I/O CONFIG > EVENTS & CONTROL > STATUS** in the Lake Controller. Please refer to the Lake Controller Operation Manual for further details.

10.2.6. Amp Gain

The Amp Gain corresponds to the gain adjustment in a conventional separate loudspeaker processor and amplifier system. When using a pre-defined Module loudspeaker preset file, the Amp Gain settings will normally remain as defined in the file. The limiter and output gain settings of the Module were configured with this gain setting and will not be automatically compensated if changes are made. This configuration scheme, though unusual, allows for compatibility with other Lake products, assuming the amplifier gain is set as specified in the speaker preset.

When creating a loudspeaker preset Module file, adjust by navigating to **I/O CONFIG > EVENTS & CONTROL > CONTROL** in the Lake Controller. Please refer to the Lake Controller Operation Manual for further details.

10.3. Gain / Level Optimization

10.3.1. Maximize Volume Capability

To maximize the volume capability of the device, ensure there is sufficient headroom in the signal path to avoid clipping before the limiters engage. It must be possible to achieve enough gain through the device to engage the limiters and realize a high average SPL. As an optimal setting, allow for a headroom of 10 dB or more for all channels; the simplest way to accomplish this is to increase the Module input gain.

10.3.2. Minimize Noise

To help provide the best volume to noise ratio, use an AES or Dante digital input signal wherever possible. If using analog inputs, ensure that unused or unnecessarily high headroom is not introduced at the input to the device. If full or high average power is not required, the Module input gain may be reduced.

10.3.3. Gain Optimization Examples

This section provides examples on performance effects resulting from changes to the PLM+ gain structure

10.3.3.1. Digital Input Gain Structure Examples

Figure 10.2 illustrates the recommended configuration of the PLM+ when using an AES or Dante digital input.

- Input Clip: 0 dBFS
- Amp Gain: 35 dB
- SNR: 114.2 dB
- Absolute Noise Floor: -71.3 dBu

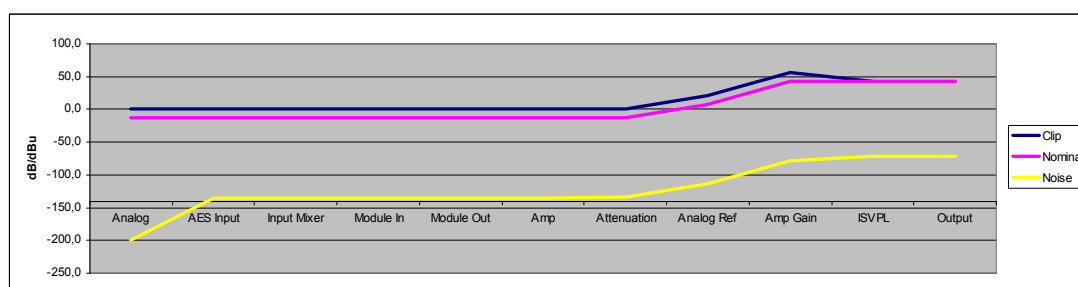

Table 10.2: Digital Input: Low Noise with Good Headroom (High Input / High SPL)

Figure 10.3 illustrates how to achieve the lowest possible output noise, although this is not a recommended configuration.

- Input Clip: 0 dBFS
- Amp Gain: 22 dB
- SNR: 114.8 dB
- Absolute Noise Floor: -71.9 dBu

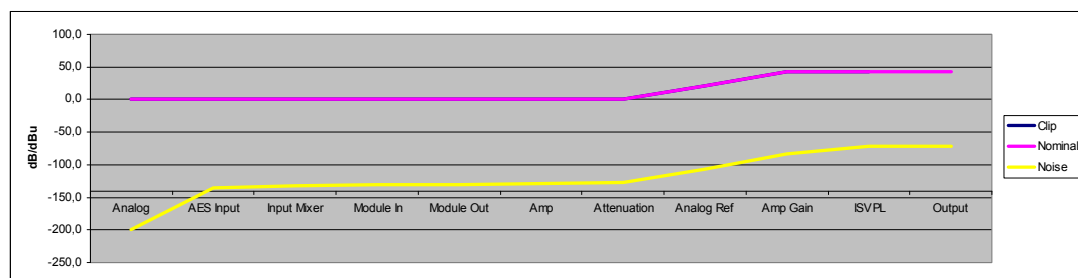

Table 10.3: Digital Input Optimized for Minimum Noise - Not Recommended

The improvement in noise performance (at the cost of losing headroom and compression features) is only 0.6 dB; it is therefore not recommended to optimize performance in this manner.

10.3.3.2. Analog Input Gain Structure Examples

Figure 10.4 illustrates how to minimize absolute noise while limiting the available SPL. Input Clip: 12 dBu

- Amp Gain: 22 dB
- SNR: 105.5 dB
- Absolute Noise Floor: -71.5 dBu
- SPL is limited to -8.9 dB relative to clip in this minimum absolute noise level example

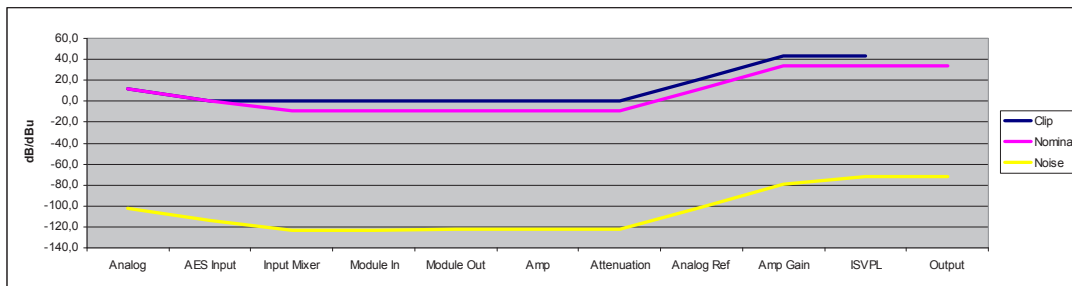

Table 10.4: Analog: Low Noise with Limited Output (Low Input / Low SPL)

Figure 10.5 illustrates how to minimize absolute noise while achieving full power. In this illustration it can be seen that there is no available headroom.

- Input Clip: 12 dBu
- Amp Gain: 30.9 dB
- SNR: 111.3 dB
- Absolute Noise Floor: -68.4 dBu

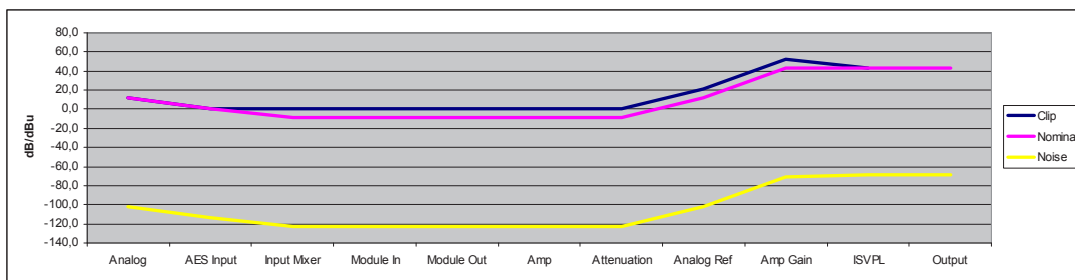

Table 10.5: Analog: Low Noise with Full Output Power (Low Input / High SPL)

Figure 10.6 illustrates how moderate noise with extreme SPL can be achieved. SPL is extremely high in this example as maximum headroom is available at the input and within the processing stage. This makes it possible to increase the average SPL by utilizing internal compression capabilities.

- Input Clip: 0 dBFS
- Amp Gain: 35 dB
- SNR: 114.2 dB
- Absolute Noise Floor: -71.3 dBu

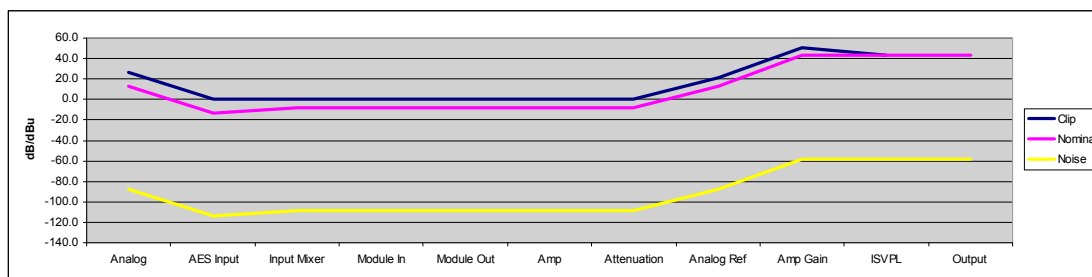

Table 10.6: Analog Input: Moderate Noise with Very High Output (Very High SPL)

10.4. Speaker Configurations

Connecting two speakers in parallel to a PLM+ power output presents a load to the amplifier which is half the impedance of that presented by one speaker. Therefore, the current that two speakers will attempt to draw from the output stage is double that for one speaker, and this higher current may be sufficient to cause the Current Peak Limiter to become active. The more speakers connected to an output in parallel, the lower the impedance and the higher the current draw.

Multiple loudspeakers may be driven by a PLM+ power output more satisfactorily if a series-parallel wiring configuration is adopted. Please ensure care is taken to match polarity correctly.

When using series-parallel wiring, the nominal impedance is the same as with one speaker; however, the principle of power sharing still applies, and it is not possible to get the amplifier section to deliver more than its rated power.



NOTE: Nominal loads as low as 2 ohms are supported by the PLM+. However, a 2 ohm nominal load has impedance dips at its resonances below 2 ohms; in such cases it is likely that the resulting higher current will cause CPL to activate.

10.5. Digital Audio Connections

Whenever possible, it is preferable to connect a digital rather than analog input signal to the device. This is particularly relevant if the source signal is already in the digital domain, such as the source from a digital mixing console or digital distribution system. The primary cause of signal distortion and signal delay (latency) is the digital-to-analog and analog-to-digital conversion process. Therefore, using digital inputs normally provides higher quality audio with lower latency.

Two types of digital audio inputs are available: Dante networked multi-channel digital audio, and 2-channel digital audio via the AES3. Dante-based system configurations and interconnections are explained in a separate document, the Lake Network Configuration Guide.

The information in this section is supplied for users unfamiliar with AES3. Users already familiar with AES3 will find that the device conforms to established conventions.

10.5.1. AES3 Digital Audio

The original AES/EBU digital audio interface standard was developed by the Audio Engineering Society in conjunction with the European Broadcast Union. Originally published in 1985, it was revised in 1992 and 2003, and in its current iteration it is properly designated the AES3 standard.

AES3 is a serial transmission format for linearly represented (uncompressed) digital audio data. It describes a method for carrying two channels of periodically sampled and uniformly quantized audio signals on a single twisted-pair cable.

The data format allows for auxiliary data which can be used for information on signal characteristics as well as the sampled audio data. The physical interconnection, as defined by IEC 60958 Type I, specifies three-conductor 110-ohm twisted pair cabling terminated by an XLR connector. Please refer to section 8.3 for wiring details. AES3 provides for multiple sampling rates and resolutions of up to 24 bits; this device accepts sample rates from 44.1 to 192 kHz.

10.5.2. System Latency and Delay Compensation

All types of digital audio processing inherently involves a small processing delay referred to as latency. If the processing chain does not involve analog-to-digital or digital-to-analog conversion, the amount of latency is usually very small and often may be disregarded.

However, in complex systems involving multiple digital audio components and connections, enough delay may be generated to cause audio phasing problems. Therefore, the lowest latency is always preferred, and it is always important to consider system latency delays when calculating and adjusting overall delay for time-aligning multiple loudspeaker systems.

10.5.3. Connections and Cabling

10.5.3.1. AES Input Connectors

Two AES-3 input signals (each carrying two audio channels) are connected to the XLR3F connectors labelled INPUT 1-2 and INPUT 3-4 in the AES/EBU (AES-3) input section on the rear panel. Note that the Input connector types are identical for the analog and digital inputs, so care must be taken when connecting audio, particularly when analog inputs are used as a backup signal source. Connectors should be clearly labeled to prevent any confusion.



NOTE: Never connect a digital signal source to an analog input or an analog signal source to a digital input.

10.5.3.2. Interconnection of Multiple Units

The AES implementation in PLM+ is designed to be able to daisy-chain AES signals using passive Y-Split cables. The PLM+ device at the end of a distribution line should be set to TERMINATED; all other PLM+ devices should be set to UNTERMINATED. If an AES3 distribution amplifier (DA) is being used to distribute the digital audio signals, with one DA output per processor, then all terminations should be on. However, if the AES3 is daisy-chained, only terminate the last processor in the chain.

Please refer to section 10.5.4 for further information.

10.5.3.3. Cable Types and Distance Limitations

All digital connections should be made with 100 ohm balanced cables wired according to the AES3 standard (see section 8.2.2). Although standard analog microphone cabling may function in limited circumstances, the potential for problems is greatly increased. AES3 contains a high-speed data stream, and requires an effective bandwidth of up to 12 MHz, far beyond the 20 kHz required for analog audio.

The distance allowed between a signal source and the PLM+ is dependent on both cable quality and the sampling rate used. At a 96 kHz sampling rate, any good quality AES3 cable should allow a cable run of 100 meters with no data losses beyond the capability of internal error correction. The best cables may allow longer cable runs, though careful trials are recommended before use in the field. Sampling rate also governs allowed cable length; a 100 meter length at 96 kHz might extend to 200 meters at 48 kHz, but be cut to 50 meters at 192 kHz.

10.5.3.4. Signal Degradation and Loss

A weak or degraded AES3 signal will exhibit no audible loss of quality as long as the robustness of the data stream remains above the threshold required for internal error correction. As degradation approaches the threshold, audible artifacts may be heard, including pops, clicks and momentary dropouts. Any such indications require immediate attention, as often the window of acceptable data loss between artifacts and complete audio loss can be very narrow.

As a precautionary measure for touring applications, it is advisable to configure all digital audio wiring prior to use. It is recommended that all cables be tested for error-free performance at lengths 20% to 25% greater than lengths to be used in the field in order to provide a comfortable margin of safety.

10.5.4. External Signal Distribution Hardware

10.5.4.1. Distribution Amplifiers

Dedicated distribution amplifiers for AES3 signals are available from several manufacturers. The most common format is one input and six outputs. Digital distribution amplifiers are designed to refresh or reconstruct the signal as well making up for line losses.

One type of distribution amplifier is a simple repeater, which restores the waveform shape and brings the signal amplitude back up to the required level. Some distribution amplifiers also offer a re-clocking feature, which also re-times the signal to prevent signal degradation from clocking errors known as jitter.

Distribution amplifiers that offer re-clocking often make the feature optional as using re-clocking can introduce small additional amounts of latency, so should not be used unless necessary.

10.5.4.2. Passive splitters

One single AES3 input may be split into more signals using a simple passive splitter. Splitters provide a convenient and low cost solution when only a few additional signals are required, and in situations where cable lengths are short. Attenuation is minimal, but there is no refreshing of the signal.

10.5.5. Additional Reference Material

Complete technical information on the AES/EBU (AES3) standard can be downloaded from the AES web site at <http://www.aes.org/publications/standards/>.

10.6. Digital Clock Configuration

10.6.1. Digital Clock Overview

In order to provide a flexible and robust audio processing system, the device is equipped with a configurable digital clocking system. The digital clock can generate various independent internal sample rates, or can sync to an incoming AES3 signal. Figure 10.7 shows the various sample rates and options available.

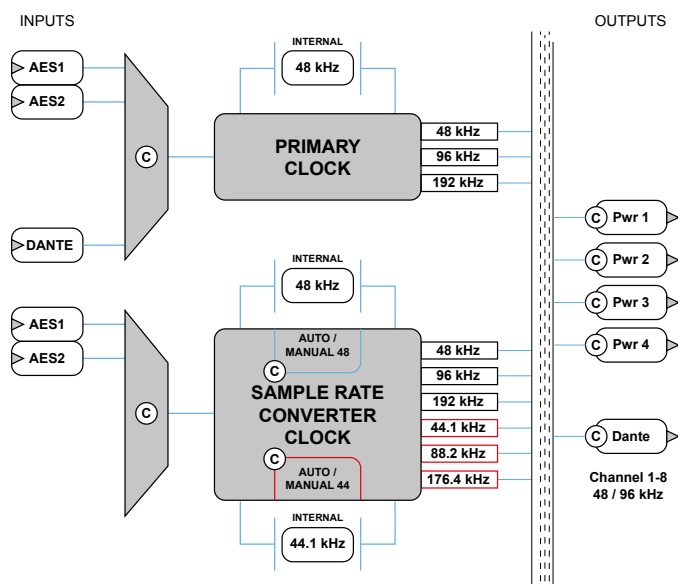

Table 10.7: Digital Clocking System

In Figure 10.7, each circled C represents a choice point. A choice point is a user-interface control that can be configured using the Lake Controller software. Please refer to the Lake Controller Operation Manual for further information.



NOTE: Figure 10.7 indicates internally generated clocks with base-rate multiples of 44.1 kHz or 48 kHz. This should not be confused with the internal DSP sample rate of 96 kHz.

The PLM+ digital clocking system can either generate its own internal clock, or synchronize to an incoming external clock source via the AES3 digital input.

10.6.2. Clock Source Priorities

There are two options for clock source configuration: Manual Configuration or Automatic Detection.

For Manual Configuration, the selected internal or external clock source remains fixed regardless of whether a compatible clock signal is preset.

For Automatic Detection, the most appropriate clock matching the selected base-rate is automatically selected according to the following priorities.

1. AES1 (Input 1+2)
2. Internal Clock

When using automatic detection, the AES3 digital input is monitored and will switch the clock source back and forth depending on the availability of an AES3 signal. Please refer to the Lake Controller Operation Manual for additional information.

10.6.3. Dante Clock Configuration

Dante uses its own digital clocking technology across the Ethernet network to ensure that all Dante devices are synchronized. As part of this logic, an order of priority is defined to identify which device becomes the Dante Master. A Dante-capable device set as Preferred Clock Master is chosen as the highest priority, followed by a device with a valid AES3 signal, then an internally generated clock.

Dante only operates at 48 kHz or 96 kHz, with the PLM+ digital clock on all Dante Slaves being overridden by the Dante Clock. When AES67 mode is enabled, the device only operates at 48 kHz (also for Dante). The PLM+ can work as Clock Master on both a Dante and AES67 audio network.

The front panel Input View indicates if that device is selected as Dante Clock Master. Confirmation of Dante Master / Slave status is also displayed in the Lake Controller. The Dante Preferred Master setting can be set from the Lake Controller I/O Configuration screen, or via the Dante Controller. For further information on Digital Clock configuration and the Lake Controller user interface, please refer to the Lake Controller Operation Manual.

11. Technical Specifications

	PLM 5K44	PLM 12K44	PLM 20K44
General			
Processing / Network	Lake / Dante		
Numbers of amplifier channels	4		
Total burst power all channels (share among channels with RPM)	5000 W	12000 W	20000 W
Max. Output Power (all ch.'s driven) ¹⁾			
2 ohms	900 W	3000 W	4400 W
2.67 ohms	1250 W	3000 W	5000 W
4 ohms	1250 W	3000 W	4400 W
8 ohms	1250 W	1900 W	2300 W
16 ohms	700 W	950 W	1150 W
Hi-Z 70 V	1300 W	3000 W	3300 W
Hi-Z 100 V	1250 W	3000 W	4700 W
Max output power single channel ¹⁾			
2 ohms	900 W	4400 W	4400 W
2.67 ohms	1250 W	5900 W	5900 W
4 ohms	1750 W	4600 W	4600 W
8 ohms	1350 W	2300 W	2300 W
16 ohms	700 W	1150 W	1150 W
Hi-Z 70 V	1450 W	3300 W	3300 W
Hi-Z 100 V	2000 W	4700 W	4700 W
Amplifier output modules (all models, all channels)			
Peak output voltage	150 V	194 V	194 V
Max output current	30 A	67 A	67 A
Rational Power Management (RPM)	Any channel has potential to deliver the max single channel output power		
Default voltage limitation (can be lifted with RPM configuration)	147 V	175 V	194 V
Protection features	Current Average Limiter (CAL), Very High Frequency Protection (VHF), Direct Current Protection (DC), Short Circuit Protection, Current-Clip Limiter, Voltage Clip Limiter, Temperature protection		
Audio Performance (Amplifier platform with digital input)			
THD + N 20 Hz - 20 kHz for 1 W	< 0.05 %	< 0.05 %	< 0.05 %
THD + N at 1 kHz and 1 dB below clipping	< 0.04 %	< 0.04 %	< 0.04 %
Dynamic range	> 112 dB	> 114 dB	> 114 dB
Channel separation (Crosstalk) at 1 kHz	> 70 dB	> 70 dB	> 70 dB
Frequency response (1 W into 8 ohm, 20 Hz - 20 kHz)	+/- 0.05 dB	+/- 0.05 dB	+/- 0.05 dB
Internal sample rate / Data path	96 KHz / 32 bit floating point	96 KHz / 32 bit floating point	96 KHz / 32 bit floating point
Product propagation delay AES 96 kHz / analog input	1.61 / 1.68 ms	1.61 / 1.68 ms	1.61 / 1.68 ms
Lake processing			
Loudspeaker processing	Up to 4 modules of Classic/linear-phase/FIR cross-over, EQ, delay, LimiterMax™ - peak and RMS limiters		
System tuning	Group control with Raised Cosine™ MESA EG™ asymmetric filters		
Input redundancy / Matrix	Automatic 4 level input redundancy / 4 input mixers		
System integration	Comprehensive 3rd party protocol over UDP Ethernet		
Measurement & Analysis			
Pilot tone generation and analysis	Yes		
Load impedance analysis	Yes		
Real Time Analyzer (RTA), 3rd party integration	Yes		
Dante Audio Network			
Dante I/O	8 X 8 (shared with AES67)		
Network topology / redundancy	Flexible topology / Supports daisy-chained and Dual redundant networks		
Sample rates / transport	48, 96 kHz / Uni + Multicast		
Network latency	0.25, 0.5, 1.0, 2.0, 5.0 ms		
AES67 Audio Network			
I/O	8 X 8 (shared with Dante)		
Network topology / redundancy	Flexible topology / Supports daisy-chained networks		
Sample rates / transport	48 kHz / Multicast		
Network latency	2 ms		
Device Presets			
Local memory locations for the settings of the product	100		
AES Inputs			
Inputs	4 AES inputs		
Supported sample rates/ resolution	44.1, 48, 88.2, 96, 176.4, 192 kHz / up to 24 bits		
Sample rate conversion THD + N 20 Hz - 20 kHz unweighted	0.00003 %		
Analog Inputs			
Inputs	4 high quality inputs with Iso-Float™ ground isolation		
Maximum input / digital reference	+ 26 dBu / +21 dBu		
Sampling rate / resolution	96 kHz / 24 bit		
Input impedance balanced / unbalanced	20 k / 10 k ohm		
THD + N (typical at 1 kHz unweighted)	0.00022 %		
THD + N (typical at 20 Hz and 20 kHz unweighted)	0.00033 %		
Limiters			
Adjustable Inter-Sample Voltage Peak Limiter (ISVPL)	17.8 - 150 V, step size 0.1 V	17.8 - 194 V, step size 0.1 V	17.8 - 194 V, step size 0.1 V
Current Peak Limiter < 300 ms	30 A peak	67 A peak	67 A peak
Current Average Limiter (CAL) > 300 ms	15 Arms	33 Arms	33 Arms

11. Technical Specifications

	PLM 5K44	PLM 12K44	PLM 20K44
Amplifier gain	22 - 44 dB, step size 0.1 dB		
Digital attenuator	- Inf to 0 dB, step size 0.25 dB		
Rear-panel interface			
Analog inputs	4 x 3 pin XLR, electronically balanced		
AES inputs	2 x 3 pin XLR		
Output connectors	Neutrik speakON (4 x NLT4) and 4 binding posts (pairs)	Neutrik speakON (1 x NLT8, 2 x NLT4) or 4 binding posts (pairs)	
Auto 100/1000, Auto Uplink	2 x RJ45 etherCON		
Control and monitoring interface	Via Ethernet for Lake Controller software, or DLM (the 3rd party protocol)		
Detachable mains cord	Detachable locking 3-pin IEC rated at 250 V / 16A	Neutrik powerCON 32 A	Neutrik powerCON 32 A
Cooling	Four fans front-to-rear airflow temperature controlled speed	Three fans front-to-rear airflow, temperature controlled speed	
Front-panel interface			
Display	2.5 inch, Black / white, daylight readable LCD		
Fault / Warning / Limit / Clip indicators	RGB LEDs and detailed fault description on display		
Mute and soft function buttons	8 provided		
Standby Power button	On / Standby		
Mute Enable button	Enables muting of outputs and inputs via soft-button keypad		
Meter button	Toggles through meter views		
Menu button	Provides a menu driven interface for full function front panel control		
Rotary Encoder	Yes		
Exit button	Provides a "back" function		
Mains power			
Nominal voltage	100 - 240 V AC 50- 60 Hz	100 - 240 V AC 45- 66 Hz	100 - 240 V AC 45- 66 Hz
Operating voltage	70 - 265 V AC		
Mains wall plug	Selectable order CEE 7/7 "Schuko" 230 V / 16 A, NEMA 5-15 125 V / 15 A, BS1363-A 250 V / 13 A, IA16A3 250 V / 16 A, AU/NZ 250 V / 10 A, JP 125 V / 15 A, CPCS-CCC 250 V / 10 A	NEMA L5-30 "Twist lock" 125 V / 30 A, and CEE 7/7 "Schuko" 230 V / 16 A	NEMA L5-30 "Twist lock" 125 V / 30 A, and CEE 7/7 "Schuko" 230 V / 16 A
Power supply features			
Soft start / Inrush power	Yes		
Power Factor Correction (PFC)	>0.98 for mains power > 300 W	>0.98 for mains power > 400 W	
Regulated switch mode power supply	Yes		
Breaker Emulation Limiter (BEL)	Configurable current threshold and breaker profile		
BEL max current threshold	15 A	25 A	32 A
Power Average Limiter (PAL)	Yes		
Under Voltage Limiter (UVL)	Yes		
Mains under voltage and overvoltage protection and mains glitch tolerance	Yes		
Dimensions			
Rack rail to rear panel	W: 483 mm (19"), H: 88 mm (2 U), D: 424 mm (16.7")		
Overall depth including handles and rear support	D: 498 mm (19.6")		
Weight			
Finish	11.4 kg (25.1 lbs)	16.5 kg (36 lbs)	17 kg (37 lbs)
Black painted steel chassis with black painted steel / aluminium front			
Approvals			
	CE, ANSI / UL 60065 (ETL), CSA C22.2 NO. 60065, PSE, RCM, FCC and CCC	CE, ANSI / UL 60065 (ETL), CSA C22.2 NO. 60065, PSE, RCM, FCC and BIS India	

Note 1): Lab.gruppen burst power (1 kHz, 25 ms burst power @ 150 BPM, 12 dB Crest factor)

All specifications are subject to change without notice.

Intercooler, Class TD and Lake are national and/or international registered trademarks of Lab.gruppen AB. PLM, Powered Loudspeaker Management, R.SMPS, LoadLibrary, LoadSmart, SpeakerSafe, BEL, UVL and ISVPL are trademarks of Lab.gruppen AB. Dolby and the double-D symbol are registered trademarks of Dolby Laboratories. Contour, Mesa Quad EQ, Mesa Parametric EQ, Raised Cosine Equalization, LimiterMax and Iso-Float are trademarks of Dolby Laboratories. Audinate is a registered trademark of Audinate Pty Ltd. Dante and Zen are trademarks of Audinate Pty Ltd. All other trademarks remain the property of their respective owners.

Copyright © 2018 MUSIC Tribe Innovation Sweden AB.

All rights reserved.

12. Warranty and support

12.1. General

This product is manufactured by Lab.gruppen, and it is warranted to be free from any defects caused by components or factory workmanship, under normal use and service, for a period of ten (10) years from date of purchase from an authorized Lab.gruppen dealer. If the product fails to perform as specified during the warranty period, Lab.gruppen will undertake to repair, or at its option, replace this product at no charge to its owner, provided the unit is returned undamaged, shipping prepaid, to an authorized service facility or to the factory. This warranty shall be null and void if the product is subjected to: repair work or alteration by a person other than those authorized by us; mechanical damage including shipping accidents; war, civil insurrection, misuse, abuse, operation with incorrect AC voltage; incorrect connections or accessories; operation with faulty associated equipment; or exposure to inclement weather conditions. Damage due to normal wear and tear is not covered by the warranty. Units on which the serial number has been removed or defaced will not be eligible for warranty service. Lab.gruppen shall not be responsible for any incidental or consequential damages. Lab.gruppen's responsibility is limited to the product itself. Lab.gruppen takes no responsibility for any loss due to cancellation of any events, or rent of replacement equipment or costs due to a third party's or customer's loss of profit, or any other indirect cost or losses however incurred. Lab.gruppen reserves the right to make changes or improvements in design or manufacturing without assuming any obligation to change or improve products previously manufactured. This warranty is exclusive, and no other warranty is expressed or implied. This warranty does not affect the customer's statutory rights.

International Warranties

Please contact your supplier or distributor for this information, as rights and disclaimers may vary from country to country.

12.2. Technical assistance and service

12.2.1. International service

If your Lab.gruppen product requires repair, contact your Lab.gruppen dealer or distributor, visit <http://labgruppen.com/support> or contact Lab.gruppen by phone or email to obtain details for the nearest authorized service center.

12.3.2. Factory Service

In the event a Lab.gruppen product requires factory service, you may contact Lab.gruppen's service department for return instructions and a Return Authorization number.

Please note for product return:

1. Use the original packing.
2. Include a copy of the sales receipt, your name, return address, phone and fax number, email address and description of the defect.
3. Mark the Return Authorization number on the outside of the packing.
4. Ship the product prepaid to:

Lab.gruppen
Faktorvägen 1
SE-434 37 Kungsbacka
SWEDEN

Phone: +46 300 56 28 00

service@labgruppen.com
www.labgruppen.com

labgruppen.com

Intercooler, Class TD and Lake are national and/or international registered trademarks of Lab.gruppen AB. PLM+, Powered Loudspeaker Management, R.SMPS, LoadLibrary, LoadSmart, SpeakerSafe, ISVPL, BEL, UVL and CAL are trademarks of Lab.gruppen AB. Dolby is a registered trademark of Dolby Laboratories. Raised Cosine Equalization, LimiterMax and Iso-Float are trademarks of Dolby Laboratories. Audinate is a registered trademark of Audinate Pty Ltd. Dante and Zen are trademarks of Audinate Pty Ltd. All other trademarks remain the property of their respective owners.

Copyright © 2018 MUSIC Tribe Brands Sweden AB. All rights reserved.

Item no. OM-PLM+