

VFR89i Specifications



FEATURES

- Two-way, full range loudspeaker
- Beamwidth-matching crossover point
- User-rotatable horn for optimized pattern control
- Easy lift handles (Black version only)

DESCRIPTION

The new VFR "i" revision brings the VF concept more fully into the EAW product line. VFR "i" Series black versions provide a handle designed into the rear of the cabinet. An installation only white version comes without handles or a pole mount cup.

The VFR89i two-way, full range loudspeaker system includes a direct-radiating, vented, 8-in LF cone transducer and a 1-in exit / 1.25-in voice coil HF compression driver loaded with a large, square, user-rotatable 90x50 coverage pattern horn built on the classic MK Series horns. These horns deliver exceptional high frequency dispersion, and their square shape lets users "rotate the enclosure around the horn" to maintain directivity in a horizontal configuration.

Because VF Series full range systems (VFR/VFM) use HF sections similar to those developed for the MK Series, EAW engineers could employ the same revolutionary "beamwidth-matching" internal passive crossover/filter networks that set the MK Series apart from all other two-way systems. If powered by an EAW-specified amplifier or via a UX Series digital signal processor, the VFR89i can enjoy the benefits of EAW Focusing, a technology that eliminates the anomalies inherent in the time domain of any loudspeaker.

The VFR89i black version includes traditional portable features such as a pole-mount cup, parallel NL4 4-terminal connectors, barrier strip connectors, an optional transformer and handles that accept accessory covers for permanent installation. The white, installation-only versions omit handles and the pole-mount cup but include NL4 connector, barrier strip connector, an optional transformer, and multiple mounting points. The new design leaves the enclosure sides completely smooth and attractive.

Six year warranty.

2-WAY FULL-RANGE LOUDSPEAKER 90° × 50°

See *NOTES TABULAR DATA* for details

CONFIGURATION

Subsystem:

	<i>Transducer</i>	<i>Loading</i>
LF	1× 8-in cone	Vented
HF	1× 1-in exit, 1.25-in voice coil compression driver	Horn-loaded

Operating Mode:

	<i>Amplifier Channels</i>	<i>External Signal Processing</i>
Single-amp	LF/HF	High pass filter

PERFORMANCE

Operating Range: 70 Hz to 20 kHz

Nominal Beamwidth: (rotatable)

Horz 90°

Vert 50°

Axial Sensitivity (whole space SPL):

LF/HF 92 dB 70 Hz to 20 kHz

Input Impedance (ohms):

	<i>Nominal</i>	<i>Minimum</i>
LF/HF	8	6.7 @ 197 Hz

Input Taps (With ACC-TXVFR Transformer installed):

	<i>70V</i>	<i>100V</i>
LF/HF	128W / 64W / 32W / 16W	128W / 64W / 32W

High Pass Filter: High Pass =>65 Hz, 12 dB/octave Butterworth

Accelerated Life Test:

LF/HF 51 V 325 W @ 8 ohm

Calculated Axial Output Limit (whole space SPL):

	<i>Average</i>	<i>Peak</i>
LF/HF	118 dB	124 dB

ORDERING DATA

Description	Part Number
EAW VFR89i Black	2041020-90
EAW VFR89i White	2041036-90
Optional Accessories	
EAW ACC TX VFR [ACC-TXVFR]	2039034
Eye Bolt Forged Shoulder M10 X 1.5 X 37mm	0029818
EAW U-Bracket V8U BLK [UBKT-V8U]	2039250
EAW U-Bracket V8U WHT [UBKT-V8U]	2039251



VFR89i Specifications

ENCLOSURE

Material Hardwood plywood
 Finish Wear resistant textured black paint
 Grille Powder-coated perforated steel

VFR89i BLACK

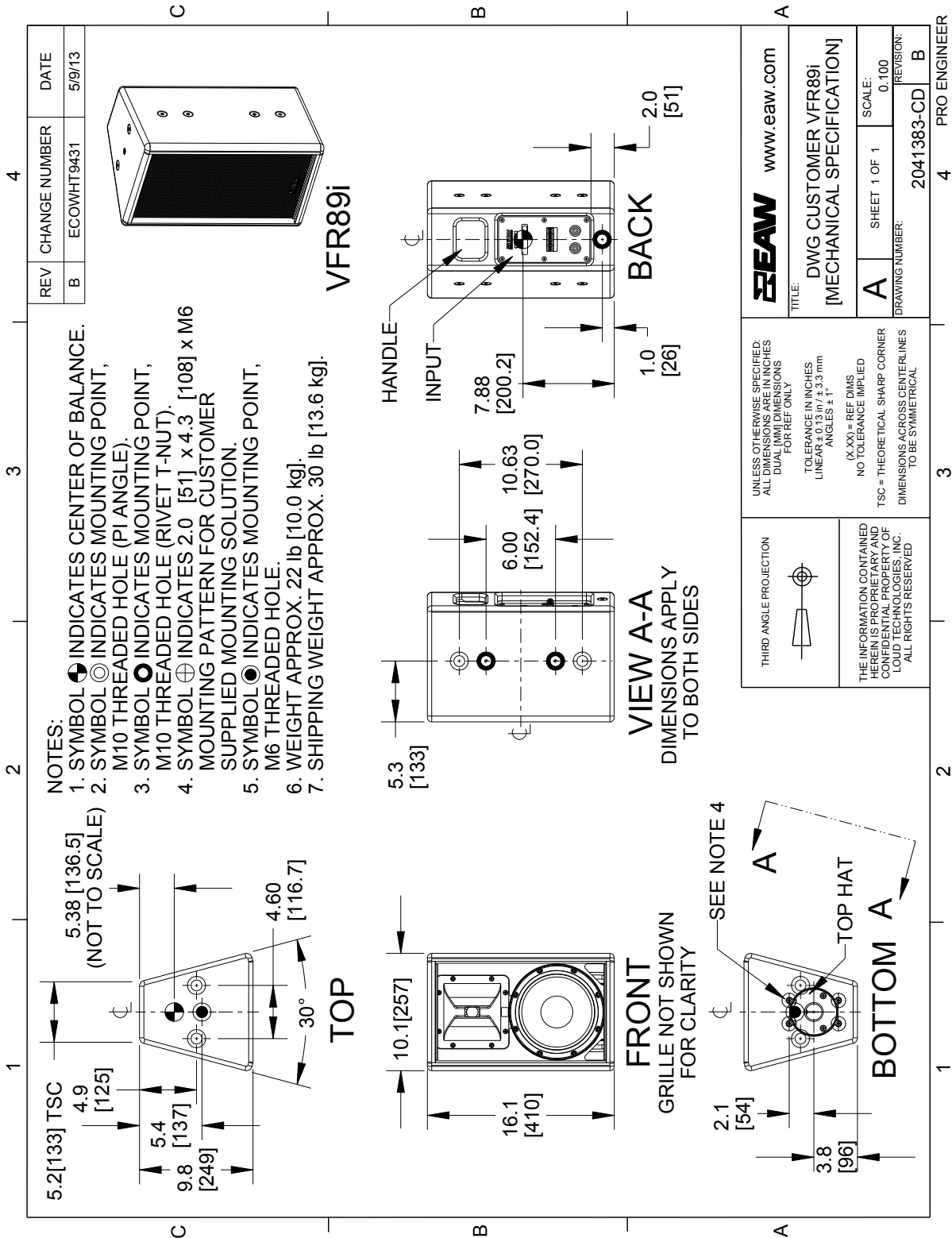

NOTE: This drawing has been reduced. Do not scale.

VFR89i Specifications

ENCLOSURE

Material	Hardwood plywood
Finish	Wear resistant textured white paint
Grille	Powder-coated perforated steel

VFR89i WHITE

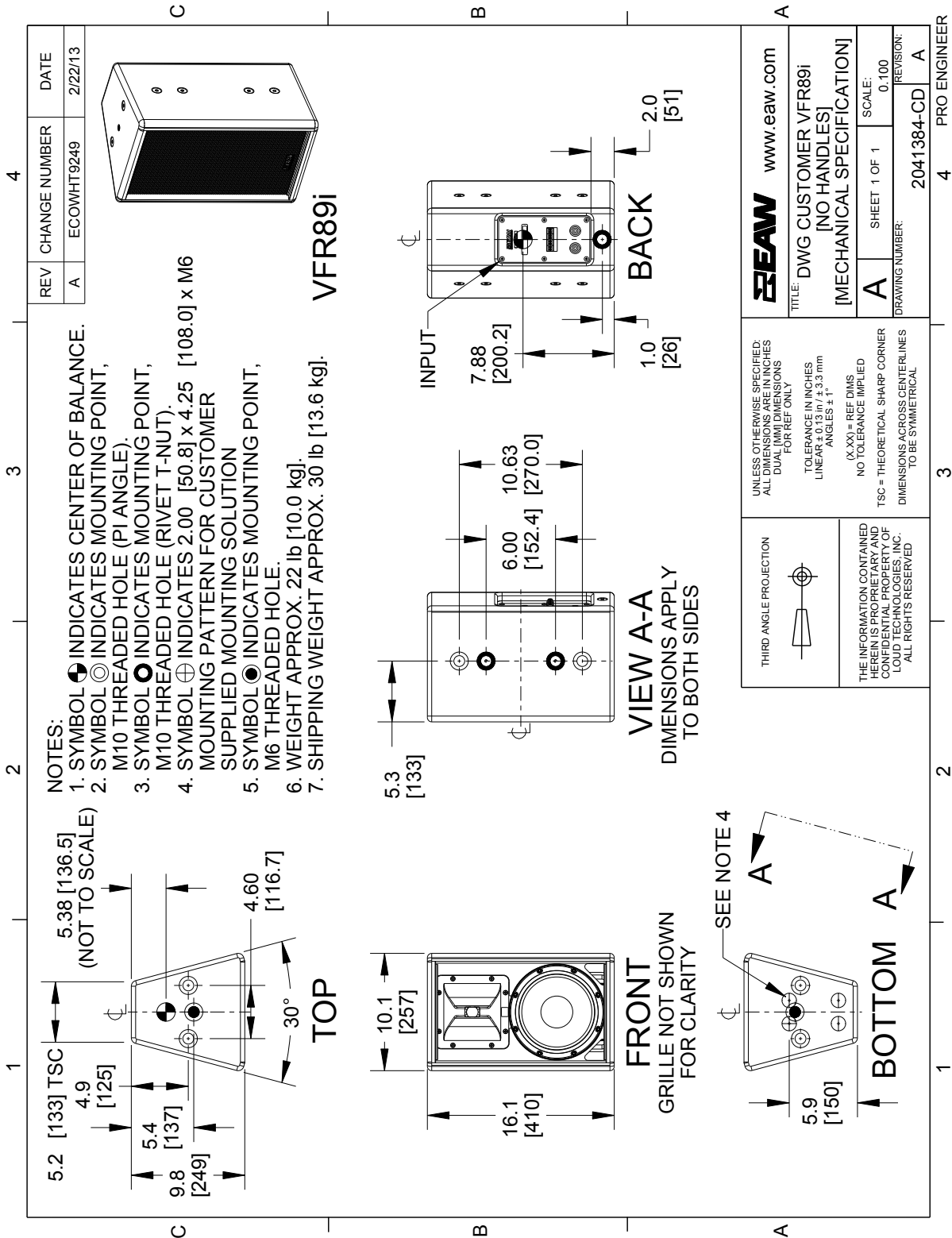

NOTE: This drawing has been reduced. Do not scale.

VFR89i Specifications

PERFORMANCE DATA

See *NOTES GRAPHIC DATA* for details

Frequency Response: Processed

Complete = blue

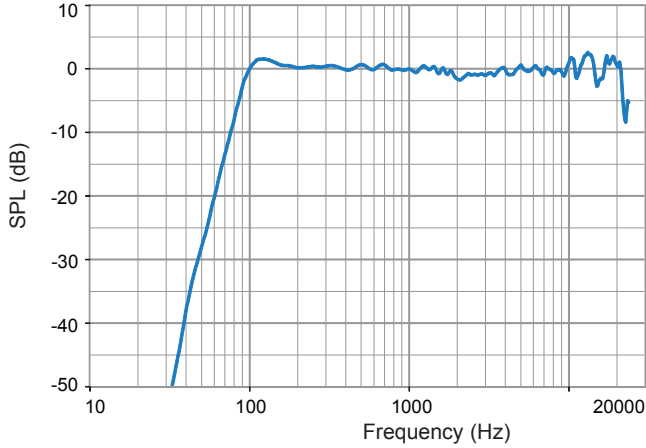

Frequency Response: Unprocessed

Complete = blue

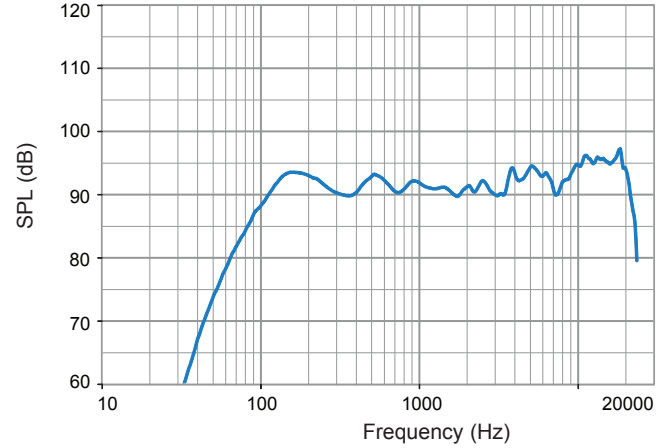

Impedance

Complete = blue

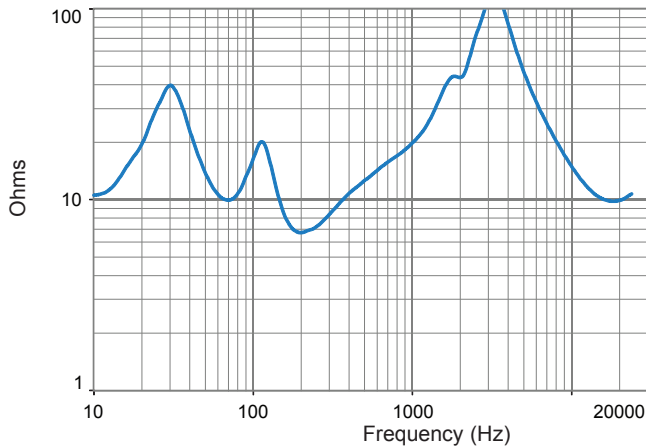

Phase Linearity

Complete = blue

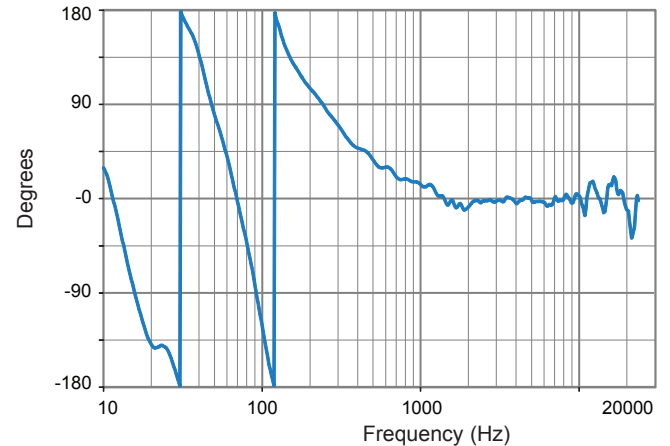

Beamwidth

Horizontal = orange Vertical = black

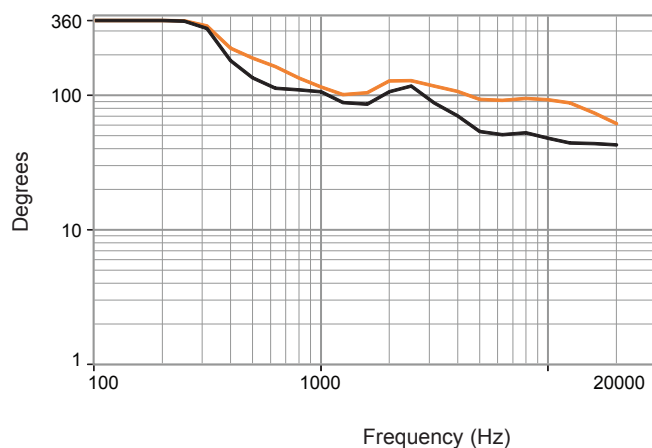

VFR89i Specifications

HORIZONTAL POLAR DATA

See *NOTES GRAPHIC DATA* for details

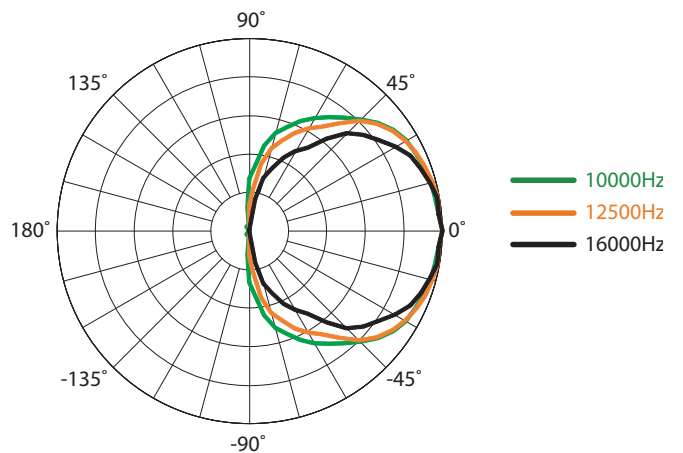
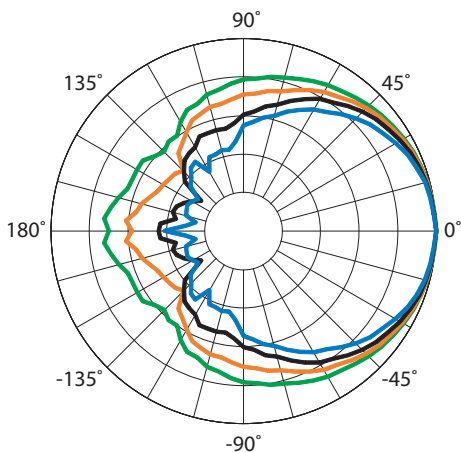
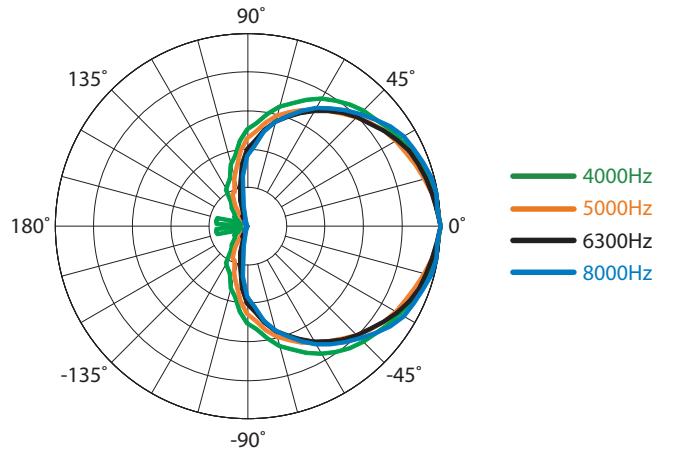
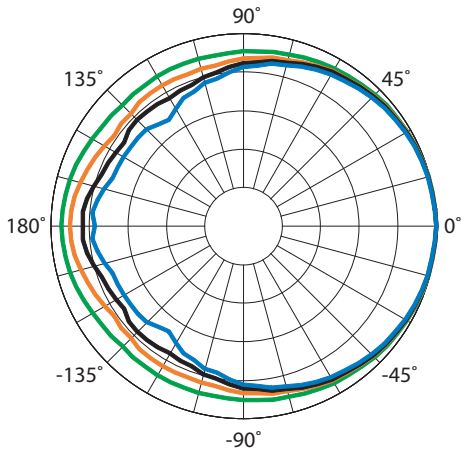
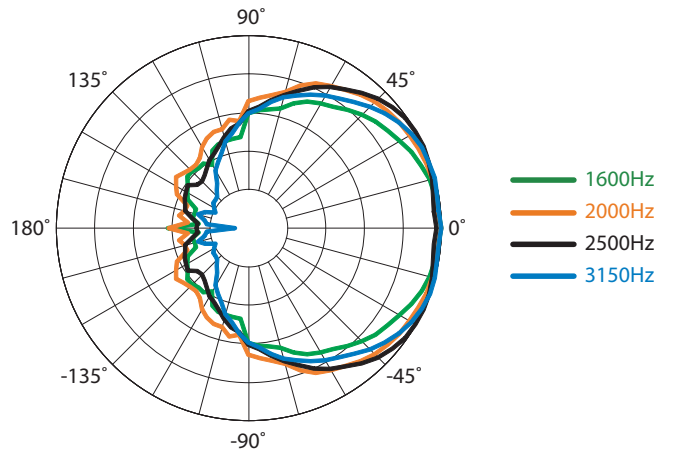
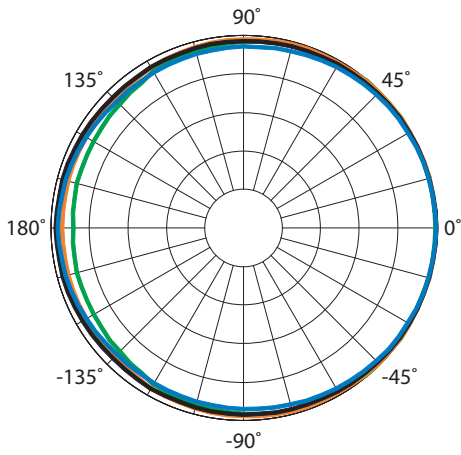

VERTICAL POLAR DATA

See *NOTES GRAPHIC DATA* for details

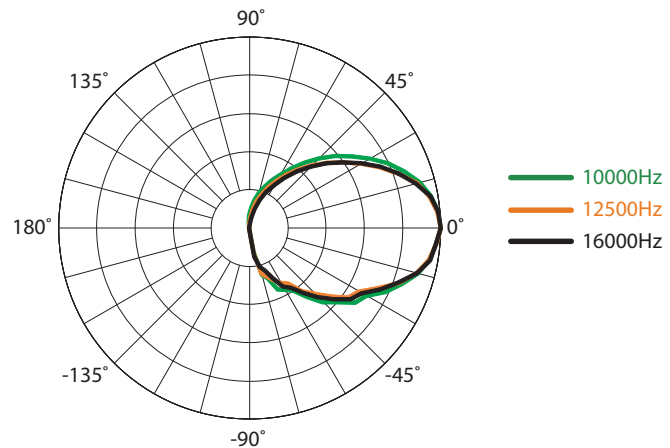
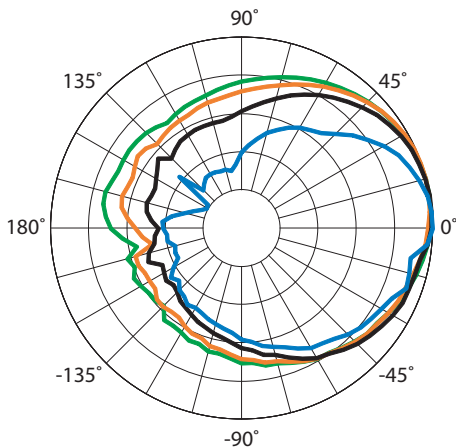
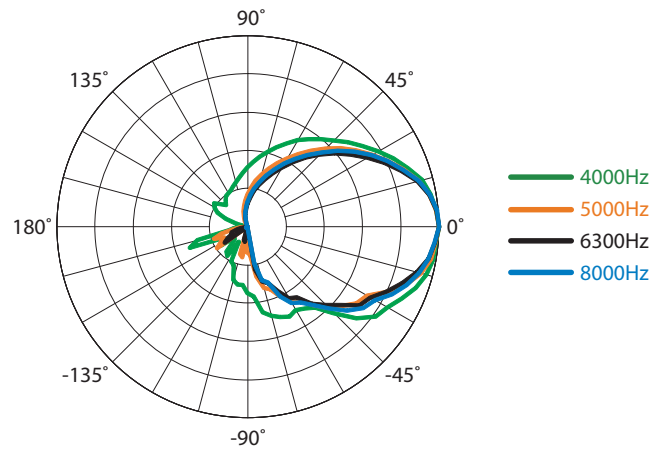
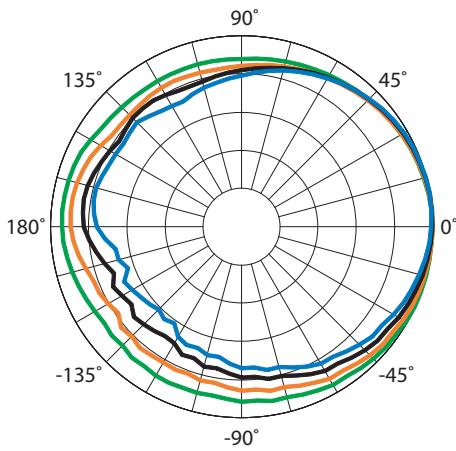
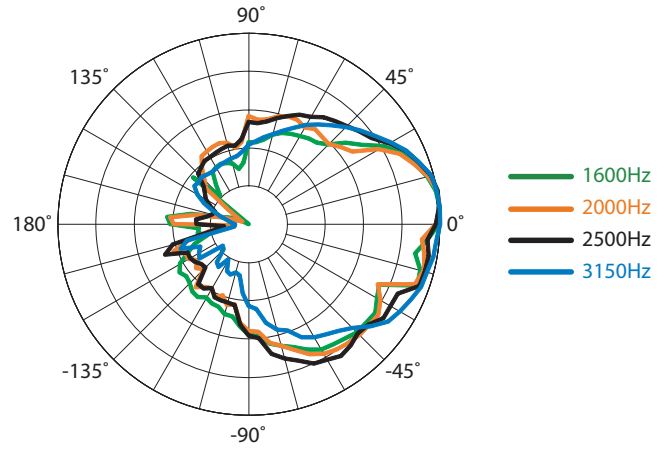
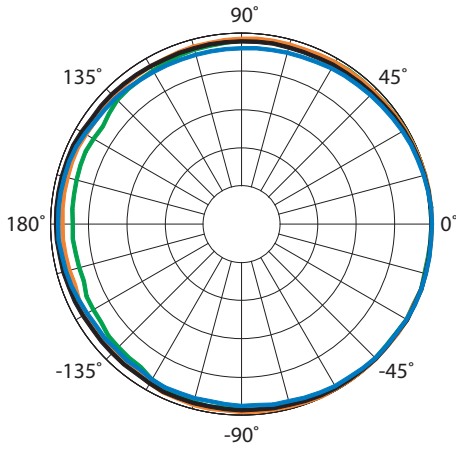

INPUT PANEL

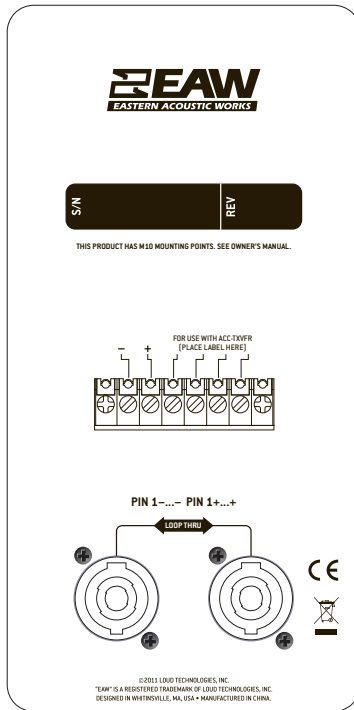

SIGNAL DIAGRAM

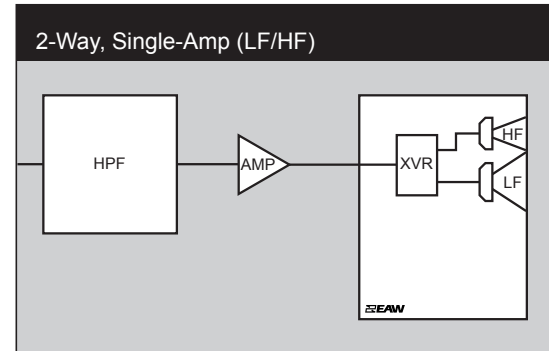

LEGEND

- HPF:** High Pass Filter for crossover –or– Recommended High Pass Filter.
- LPF:** Low Pass Filter for crossover.
- LF/MF/HF:** Low Frequency / Mid Frequency / High Frequency.
- AMP:** User Supplied Power Amplifier –or– Integral Amplifier for NT products.
- XVR:** Passive LPFs, HPFs, and EQ integral to the loudspeaker.
- EAW Focusing:** Digital Signal Processor capable of implementing EAW Focusing.

NOTES

TABULAR DATA

1. **Measurement/Data Processing Systems:** Primary - FChart: proprietary EAW software; Secondary - Brüel & Kjær 2012.
2. **Microphone Systems:** Earthworks M30; Brüel & Kjær 4133
3. **Measurements:** Dual channel FFT; length: 32 768 samples; sample rate: 48 kHz; logarithmic sine wave sweep.
4. **Measurement System Qualification** (includes all uncertainties): SPL: accuracy +/-0.2 dB @ 1 kHz, precision +/-0.5 dB 20 Hz to 20 kHz, resolution 0.05 dB; Frequency: accuracy +/-1 %, precision +/-0.1 Hz, resolution the larger of 1.5 Hz or 1/48 octave; Time: accuracy +/-10.4 µs, precision +/-0.5 µs, resolution 10.4 µs; Angular: accuracy +/-1°, precision +/-0.5°, resolution 0.5°.
5. **Environment:** Measurements time-windowed and processed to eliminate room effects, approximating an anechoic environment. Data processed as anechoic or fractional space, as noted.
6. **Measurement Distance:** 7.46 m. Acoustic responses represent complex summation of the subsystems at 20 m. SPL is referenced to other distances using the Inverse Square Law.
7. **Enclosure Orientation:** For beamwidth and polar specifications, as shown in Mechanical Specification drawing.
8. **Volts:** Measured rms value of the test signal.
9. **Watts:** Per audio industry practice, "loudspeaker watts" are calculated as voltage squared divided by rated nominal impedance. Thus, these are not True Watt units of energy as defined by International Standard.
10. **SPL:** (Sound Pressure Level) Equivalent to the average level of a signal referenced to 0 dB SPL = 20 microPascals.
11. **Subsystem:** This lists the transducer(s) and their acoustic loading for each passband. Sub = Subwoofer, LF = Low Frequency, MF = Mid Frequency, HF = High Frequency.
12. **Operating Mode:** User selectable configurations. Between system elements, a comma (,) = separate amplifier channels; a slash (/) = single amplifier channel. DSP = Digital Signal Processor. IMPORTANT: To achieve the specified performance, the listed external signal processing must be used with EAW-provided settings.
13. **Operating Range:** Range where the processed Frequency Response stays within -10 dB SPL of the power averaged SPL within this range; measured on the geometric axis. Narrow band dips are excepted.
14. **Nominal Beamwidth:** Design angle for the -6 dB SPL points, referenced to 0 dB SPL as the highest level.
15. **Axial Sensitivity:** Power averaged SPL over the Operating Range with an input voltage that would produce 1 W at the nominal impedance; measured with no external processing on the geometric axis, referenced to 1 m.
16. **Nominal Impedance:** Selected 4, 8, or 16 ohm resistance such that the minimum impedance point is no more than 20% below this resistance over the Operating Range.
17. **Accelerated Life Test:** Maximum test input voltage applied with an EIA-426B defined spectrum; measured with recommended signal processing and Recommended Protection Filter.
18. **Calculated Axial Output Limit:** Highest average and peak SPLs possible during the Accelerated Life Test. The Peak SPL represents the 2:1 (6 dB) crest factor of the Life Test signal.
19. **High Pass Filter:** This helps protect the loudspeaker from excessive input signal levels at frequencies below the Operating Range.

GRAPHIC DATA

1. **Resolution:** To remove insignificant fine details, 1/12 octave cepstral smoothing was applied to acoustic frequency responses and 1/3 octave cepstral smoothing was applied to the beamwidth and impedance data. Other graphs are plotted using raw data.
2. **Frequency Responses:** Variation in acoustic output level with frequency for a constant input signal. Processed: normalized to 0 dB SPL. Unprocessed inputs: 2 V (4 ohm nominal impedance), 2.83 V (8 ohm nominal impedance), or 4 V (16 ohm nominal impedance) referenced to a distance of 1 m.
3. **Processor Response:** The variation in output level with frequency for a constant input signal of 0.775 V = 0 dB reference.
4. **Beamwidth:** Average angle for each 1/3 octave frequency band where, starting from the rear of the loudspeaker, the output first reaches -6 dB SPL referenced to 0 dB SPL as the highest level. This method means the output may drop below -6 dB SPL within the beamwidth angle.
5. **Impedance:** Variation in impedance magnitude, in ohms, with frequency without regard to voltage/current phase. This means the impedance values may not be used to calculate True Watts (see 9 above).
6. **Polar Data:** Horizontal and vertical polar responses for each 1/3 octave frequency band 100 Hz to 16 kHz or Operating Range.