

# **EA** EAW<sup>®</sup>

**EASTERN ACOUSTIC WORKS**



## **nTX series**

***User Manual***

# IMPORTANT SAFETY INSTRUCTIONS – READ THIS FIRST

## Safety Instructions

Read and heed all warnings and safety instructions in this manual before using this product. Failure to follow these precautions may result in damage, injury, or death.

- 1) Read these instructions.
- 2) Keep these instructions.
- 3) Heed all warnings.
- 4) Follow all instructions.
- 5) Do not use this apparatus near water.
- 6) Clean only with a dry cloth.
- 7) Do not block any amplifier ventilation openings. Install in accordance with the manufacturer's instructions.
- 8) Do not install near any heat sources such as radiators, heat registers, stoves, or other apparatus that produce heat.
- 9) Do not defeat the safety purpose of the polarized or grounding-type plug. A polarized plug has two blades with one wider than the other. A grounding type plug has two blades and a third grounding prong. The wide blade or the third prong is provided for your safety. If the provided plug does not fit into your outlet, consult an electrician for replacement of the obsolete outlet.
- 10) Protect the power cord from being walked on or pinched particularly at plugs, convenience receptacles, and the point where they exit from the apparatus.
- 11) Only use attachments/accessories specified by the manufacturer.
- 12) Use only with a cart, stand, tripod, bracket, or table specified by the manufacturer, or sold with the apparatus. When a cart is used, use caution when moving the cart/apparatus combination to avoid injury from tip-over. In addition, use only with the Caster Pallets and flybars specified by the manufacturer, or sold with the apparatus. When a Caster Pallet is used, use caution when moving the apparatus combination to avoid injury from tip-over.
- 13) Unplug this apparatus during lightning storms or when unused for long periods of time.
- 14) The AC Mains PowerCon True1 Top connector (the appliance coupler) is used as the disconnect device. This connector shall remain readily accessible and operable.
- 15) Refer all servicing to qualified service personnel. Servicing is required when the apparatus has been damaged in any way, such as power-supply cord or plug is damaged, liquid has been spilled or objects have fallen into the apparatus, does not operate normally, or has been dropped.



**WARNING:** To reduce the risk of fire or electric shock, do not expose this apparatus to rain or moisture.

**WARNING:** If the AC mains connectors on this product are not compatible with the local AC mains receptacle, employ a licensed electrician to provide the proper connector and voltage to interface with the product. Ensure that the AC power supply has a properly grounded safety ground. Failure to follow this warning could cause damage, injury, or death.

## CONSIGNES DE SÉCURITÉ – À LIRE EN PREMIER



The lightning flash with arrowhead symbol within an equilateral triangle is intended to alert the user to the presence of uninsulated "dangerous voltage" within the product's enclosure, that may be of significant magnitude to constitute a risk of electric shock to persons.

### Instructions Relative à la Sécurité

Lisez et respectez toutes les consignes de sécurité et les mises en garde fournies dans le manuel des enceintes EAW avant d'utiliser ce produit. Le non-respect de ces consignes et mises en garde peut entraîner des dommages aux équipements et des accidents aux personnes pouvant être fatals.

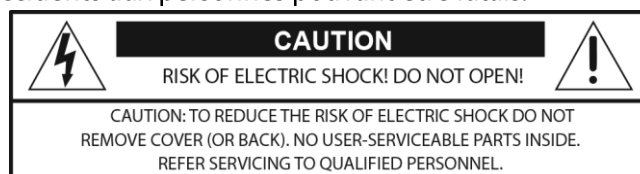

**ATTENTION:** Si l'alimentation secteur connecteurs sur ce produit ne sont pas compatibles avec l'AC locale secteur Embase, employer un électricien agréé pour fournir le connecteur et la tension appropriée à l'interface avec le produit. Assurez-vous que l'alimentation en courant alternatif a une terre de sécurité à la terre. Le non-respect de cet avertissement peut causer des dommages, des blessures ou la mort.

**ATTENTION:** Si ce produit contient une batterie au lithium, danger d'explosion si la pile au lithium est remplacée de façon incorrecte. Ne tentez pas de remplacer la batterie vous-même.

## PRECAUZIONI DI SICUREZZA - DA LEGGERE PER PRIMO

### Norme di Sicurezza

Prima di procedere con l'utilizzo del prodotto, leggere e rispettare ogni avvertenza e norma di sicurezza riportata nel "Manuale EAW Loudspeaker". Il mancato rispetto di ogni precauzione può causare danni all'apparecchiatura, nonché infortuni alle persone o la morte.

**ATTENZIONE:** Se i connettori di rete AC su questo prodotto non sono compatibili con il CA locale di rete presa, impiegare un elettricista per fornire il connettore corretto e la tensione di interfacciarsi con il prodotto. Assicurarsi che l'alimentazione CA ha una terra di sicurezza a terra. La mancata osservanza di questa indicazione può causare danni, lesioni o morte.

**ATTENZIONE:** Se questo prodotto contiene una batteria al litio, pericolo di esplosione se la batteria al litio non è sostituita correttamente. Non tentare di sostituire la batteria da soli.

## PRECAUCIONES DE SEGURIDAD - LEA EST O PRIMERO

### Instrucciones de Seguridad

Lea y observe todos los avisos e instrucciones de seguridad que aparecen en el "Manual de altavoces EAW" adjunto antes de usar este aparato. El no observar esta precaución puede dar lugar a averías en el aparato, daños en las personas o incluso la muerte.

**PRECAUCION:** Si los conectores de red eléctrica de CA de este producto no son compatibles con el CA local de red receptáculo, emplear un electricista autorizado para proporcionar el conector y el voltaje para interactuar con el producto. Asegúrese de que la fuente de alimentación de CA tiene una conexión a tierra a tierra adecuada. El incumplimiento de esta advertencia podría causar daños, lesiones o muerte.

**PRECAUCIÓN:** Si este producto contiene una batería de litio, peligro de explosión si la batería de litio se sustituye de forma incorrecta. No intente reemplazar la batería usted mismo.

## SICHERHEITSHINWEISE - LESEN SIE DIESEN ABSCHNITT ZUERST

### Sicherheitsanweisungen

Lesen und beachten Sie alle Warnungen und Sicherheitsanweisungen der mitgelieferten "EAW Lautsprecher Bedienungsanleitung" vor der Benutzung des Produkts. Nichtbeachtung dieser Hinweise können möglicherweise zu Schäden am Equipment oder zu Verletzungen bzw. zum Tod von Personen führen.

**WARNUNG:** Wenn die AC-Netzstecker auf diesem Produkt nicht kompatibel sind mit der lokalen Netzsteckdose Netz, verwenden einen Elektrofach den richtigen Anschluss und Spannung als Schnittstelle mit dem Produkt zur Verfügung zu stellen. Stellen Sie sicher, dass die Stromversorgung einwandfrei geerdete Schutzterde hat. Die Nichtbeachtung dieser Warnung kann zu Schäden, Verletzungen oder zum Tod führen.

**ACHTUNG:** Falls dieses Produkt eine Lithium-Batterie, Explosionsgefahr enthält, wenn Lithium-Batterie falsch eingesetzt wird. Versuchen Sie nicht, die Batterie selbst zu ersetzen.

**CAUTION:** If this product contains a lithium battery, danger of explosion if lithium battery is incorrectly replaced. Do not attempt to replace the battery yourself. Note: This equipment has been tested and found to comply with the limits for a Class A digital device, pursuant to part 15 of the FCC Rules. These limits are designed to provide reasonable protection against harmful interference when the equipment is operated in a commercial environment. This equipment generates, uses, and can radiate radio frequency energy and, if not installed and used in accordance with the instruction manual, may cause harmful interference to radio communications. Operation of this equipment in a residential area is likely to cause harmful interference in which case the user will be required to correct the interference at his own expense.

CAUTION: Changes or modifications not expressly approved by EAW North America® could void the user's authority to operate the equipment under FCC rules.

### Correct Disposal of this Product

This symbol indicates that this product should not be disposed of with your household waste, according to the WEEE Directive (2012/19/EU) and your national law. This product should be handed over to an authorized collection site for recycling waste electrical and electronic equipment (WEEE). Improper handling of this type of waste could have a possible negative impact on the environment and human health due to potentially hazardous substances that are generally associated with WEEE.



At the same time, your cooperation in the correct disposal of this product will contribute to the effective usage of natural resources. For more information about where you can drop off your waste equipment for recycling, please contact your local city office, waste authority, or your household waste disposal service.

## Electrical Warnings

### AC Mains Supply

Read all instruction and cautionary notes concerning electrical power in this document.

### ALIMENTATION SECTEUR

Lisez toutes les instructions et mises en garde concernant les notes d'énergie électrique dans le présent document.

### ALIMENTAZIONE AC

Leggi tutte le note di istruzione e di cautela in materia di energia elettrica in questo documento.

### FUENTE DE ALIMENTACIÓN

Lee todas las notas de instrucciones y advertencias relativas a la energía eléctrica en este documento.

### NETZSTROMVERSORGUNG

Alle Anweisung und Hinweise bezüglich elektrischer Energie in diesem Dokument.

### AC Mains Cable

If the AC mains connectors on this product are not compatible with the local AC mains receptacle, employ a licensed electrician to provide the proper connector and voltage to interface with the product. Ensure that the AC power supply has a properly grounded safety ground. Failure to follow this warning could cause damage, injury, or death.

Ensure that AC power supply has a properly grounded safety ground. Failure to follow this warning could cause equipment damage, injury, or death.

### Cordon secteur

Il se peut que le format de la fiche secteur ne corresponde pas à celui de votre situation géographique. Dans ce cas, faites appel à un électricien agréé pour qu'il remplace la fiche par une autre du bon format. Respectez les normes électriques de câblage locales.

Assurez-vous que la ligne secteur dispose d'une terre. Le non-respect de cette précaution peut entraîner des dommages aux équipements et des accidents aux personnes pouvant être fatals.

## Cavo d'alimentazione AC

Il connettore del cavo d'alimentazione AC fornito in dotazione potrebbe non essere adeguato per le prese di corrente impiegate nell'area in cui il diffusore viene utilizzato. In questo caso, contattare un elettricista qualificato per sostituire la presa di corrente con una dotata di connessione adeguata. Per il cablaggio, occorre seguire la codifica corretta utilizzata nell'area d'utilizzo.

Assicurarsi che la presa d'alimentazione sia correttamente collegata a terra. Il mancato rispetto di tali avvertenze potrebbe causare danni all'apparechiatura, nonché infortuni alle persone o la morte.

## Cable de alimentación

El enchufe que viene en el cable de alimentación incluido puede que no encaje en las salidas de corriente de su zona. Si ocurre esto, contacte con un electricista profesional para que sustituya el enchufe problemático y lo cambie por uno adecuado para la salida de corriente. Compruebe que se sigan todas las normativas de seguridad aplicables.

Asegúrese que la fuente de alimentación tenga una conexión a tierra correcta. El no cumplir con esta advertencia puede dar lugar a daños en el equipo, en las personas que lo manejen o incluso la muerte.

## Netzkabel

Das mitgelieferte Netzkabel besitzt möglicherweise einen Netzstecker, der nicht in Ihre Steckdose passt. In diesem Fall können Sie sich von einem zugelassenen Elektrobetrieb einen passenden Netzstecker unter Berücksichtigung der jeweils gültigen Vorschriften montieren lassen.

Stellen Sie sicher, dass der Schutzleiter der Netzsteckdose eine gute Verbindung zur Erde hat. Nichtbeachtung dieses Hinweises kann zu Schäden am Equipment, zu Verletzungen oder zum Tod führen.

## Suspension Warnings

Suspending anything, especially overhead of people, should be done with extreme caution. Always engage the services of a certified professional who is qualified to determine the requirements for and to implement overhead rigging. Only persons with the knowledge of proper hardware and safe rigging techniques should attempt to suspend loudspeakers overhead. Failure to follow these precautions may result in damage, injury, or death.

### Avertissements de suspension

**AVERTISSEMENT:** Suspendre quoi que ce soit, en particulier les frais généraux de personnes, doit être fait avec une extrême prudence. Toujours engager les services d'un professionnel certifié qui est qualifié pour déterminer les conditions requises et à mettre en œuvre le gréement en tête. Seules les personnes ayant la connaissance du matériel approprié et les techniques sécuritaires de gréage devraient tenter de suspendre les haut-parleurs au-dessus. Le non-respect de ces précautions peut entraîner des dommages, des blessures ou la mort.

### Avvertenze sospensione

**AVVERTENZA:** Sospendere nulla, soprattutto sovraccarico di persone, deve essere fatto con estrema cautela. Inserire sempre i servizi di un professionista certificato che si è qualificato per determinare i requisiti di e ad attuare manovre in testa. Solo le persone con la conoscenza di tecniche di assemblaggio di sicurezza hardware e dovrebbero tentare di sospendere gli altoparlanti in testa. La mancata osservanza di queste precauzioni può provocare danni, lesioni o morte.

## Advertencias de suspensión

**ADVERTENCIA:** La suspensión de cualquier cosa, especialmente por encima de las personas, se debe hacer con mucho cuidado. Siempre contratar los servicios de un profesional certificado que está calificado para determinar los requisitos para implementar y para las maniobras de elevación. Sólo las personas con el conocimiento de las técnicas de aparejo de seguridad de hardware adecuada y deben intentar suspender altavoces por encima. El incumplimiento de estas precauciones puede resultar en daños, lesiones o muerte.

## Suspension Warnungen

**WARNUNG:** Schwebend alles, vor allem Aufwand von Menschen, sollte mit äußerster Vorsicht erfolgen. Immer engagieren, die Dienste eines zertifizierten Profi, der qualifiziert ist, die Anforderungen zu bestimmen und Überkopfmontage zu implementieren. Nur Personen mit der Kenntnis der richtigen Hardware und sichere Rigging Techniken sollten Lautsprecher Kopf auszusetzen versuchen. Die Nichtbeachtung dieser Vorsichtsmaßnahmen kann zu Schäden, Verletzungen oder zum Tod führen.

# Table of Contents

IMPORTANT SAFETY INSTRUCTIONS – READ THIS FIRST .....	1
CONSIGNES DE SÉCURITÉ – À LIRE EN PREMIER.....	1
PRECAUZIONI DI SICUREZZA - DA LEGGERE PER PRIMO .....	2
PRECAUCIONES DE SEGURIDAD - LEA EST O PRIMERO.....	2
SICHERHEITSHINWEISE - LESEN SIE DIESEN ABSCHNITT ZUERST.....	2
Electrical Warnings.....	3
AC Mains Supply.....	3
ALIMENTATION SECTEUR .....	3
ALIMENTAZIONE AC .....	3
FUENTE DE ALIMENTACIÓN .....	3
NETZSTROMVERSORGUNG .....	3
AC Mains Cable.....	3
Cordon secteur .....	3
Cavo d'alimentazione AC.....	4
Cable de alimentación .....	4
Netzkabel.....	4
Suspension Warnings .....	4
Table of Contents .....	6
Functionality and Operation.....	8
NTX SERIES Back Panel Connectors and Controls .....	8
SBX SERIES Subwoofer Connectors and Controls .....	8
AC Mains Connection .....	9
Linking power .....	9
Audio Connections .....	9
Dante A / B .....	10
DSP Navigation / Edit Wheel .....	10
LCD UI Display .....	10
Front Panel LED .....	10
NTX210L Walkaround .....	11
SBX218 Walkaround.....	11
SBX118 Walkaround.....	12
Patented Infrared (IR) Transceivers [NTX Line Array] .....	13
Rigging Assemblies / Rigging Pins [NTX Line Array] .....	13
Handles.....	14
Rear Panel Home Screen and Menu Navigation .....	14
Level .....	14
OptiLogic (For line array items only) .....	14
Crossover.....	15
Cardioid (For SBX118/SBX218).....	16

Voicing.....	16
Delay.....	17
Output Check.....	17
Settings.....	18
Home Screen .....	19
A Further Look into Dante™ .....	20
Introduction .....	20
Why use Dante?.....	20
Using EAW Resolution 2.....	21
Rigging Instructions .....	22
Accessories.....	24
Service, Inspection & Maintenance.....	27



# Functionality and Operation

## NTX SERIES Back Panel Connectors and Controls

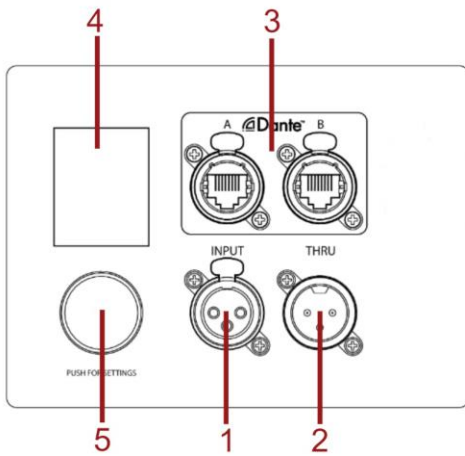

- 1 **XLR Input**
- 2 **XLR Thru**
- 3 **Dante A / B**
- 4 **LCD UI Display**
- 5 **DSP Navigation / Edit Wheel**
- 6 **Front Panel LED**

Connect Analog input signals.  
Loop input signal to additional NTX or SBX products, or other devices  
Primary Dante network.  
Displays the current UI information.  
Navigate, edit and select parameters.  
Power Indicator / Status.

## SBX SERIES Subwoofer Connectors and Controls

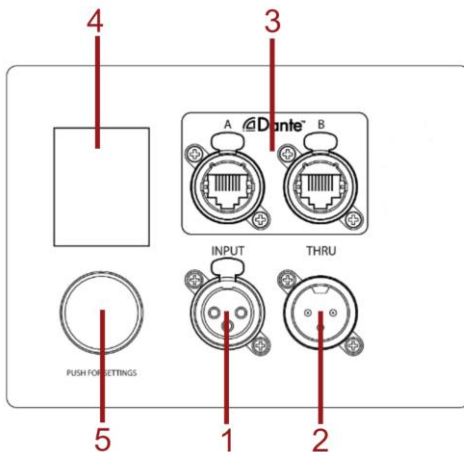

- 1 **XLR Input**
- 2 **XLR Thru**
- 3 **Dante A / B**
- 4 **LCD UI Display**
- 5 **DSP Navigation / Edit Wheel**
- 6 **Front Panel LED**

Connect Analog input signals.  
Loop input signal to additional NTX or SBX products, or other devices  
Primary Dante network.  
Displays the current UI information.  
Navigate, edit and select parameters.  
Power Indicator / Status.

## AC Mains Connection

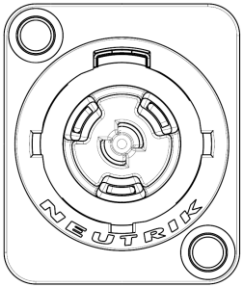

Connect the supplied AC mains cord to the powerCON® True1 socket on the rear of the NTX & SBX. The True1 system utilizes a locking connector. To lock, twist 1/4 turn clockwise after fully inserting it into the AC MAINS receptacle. Connect the other end to an AC mains supply receptacle, nominally as seen on back panel. If necessary, have a qualified electrician change the cable plug as required for compatibility with the local AC mains receptacle.

**WARNING:** Before connecting an NTX & SBX to the AC mains supply, completely turn down the input signal using the input level attenuator. If not, there could be excessive and possibly damaging sound levels from the loudspeaker when energized.

There is no power switch. When connected to the AC mains, the loudspeaker will be fully operational, with the output level controlled by the signal source feeding it.

## Linking power



The Neutrik powerCON® True1 AC mains and AC loop connectors are wired in parallel to provide an AC mains inlet and outlet on each NTX & SBX. The AC mains inlet mates with a True1 female connector.

The AC Loop outlet mates with a True1 male connector. Therefore, to loop the AC mains from enclosure to enclosure, connect an AC mains jumper cable.



Up to two additional NTX210L or SBX118 may be looped in this fashion at 115v, and five additional units may be looped at 230v. Up to two additional SBX218 may be looped in this fashion at 230v. Use an AC loop connector to daisy-chain AC mains power from one enclosure to another.

The maximum ambient operating temperature for NTX210L is 45°C.

The included NEMA 5-15P cable should only be used to power a single unit of any type.

## Audio Connections

### Analog Audio

Connect the output from your line-level signal source to the XLR-3F INPUT connector on the rear panel. This is an electronically balanced input. Users must provide their own XLR cables. The XLR-type connectors on the rear of each NTX & SBX are designed for professional audio signal levels, nominally 0 dBu (= 0.775 V). Normally, use the female XLR as the signal input. Use a male XLR as a loop-thru output to connect the same signal input to additional modules.

The wiring convention is as follows:

- Pin 1: Shield
- Pin 2: + / Hot
- Pin 3: - / Cold

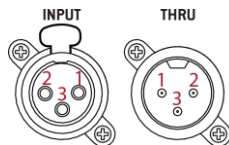

## Dante A / B

### Digital Audio

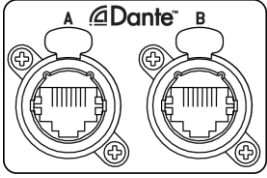

These Dante ports are for connecting one NTX or SBX to another module (or another Dante-enabled device) via CAT5e (or better) Ethernet cable. This features dual Dante ports (Ultimo Chip) for daisy chaining.

## DSP Navigation / Edit Wheel

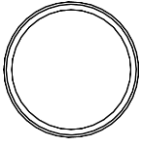

Rotate (or push-click) the encoder to open settings, navigate the user interface and edit parameters and select values.

This endless rotary wheel allows you to navigate the user interface, edit sections of NTX & SBX and navigate within screens to select sub-menus, pages and parameters, as well as select values during editing.

PUSH FOR SETTINGS

## LCD UI Display



The LCD UI displays all the menu navigation information. When NTX & SBX is powered on, it will load up the last state it was in when powered off.

## Front Panel LED

The front panel LED illuminates when the AC Mains of NTX & SBX is plugged into a suitable AC powersupply.

As seen below, the front panel LED only illuminates in 'Identify'.

MODE	BOOT	IDENTIFY
OFF	OFF	WHITE

NTX210L Walkaround

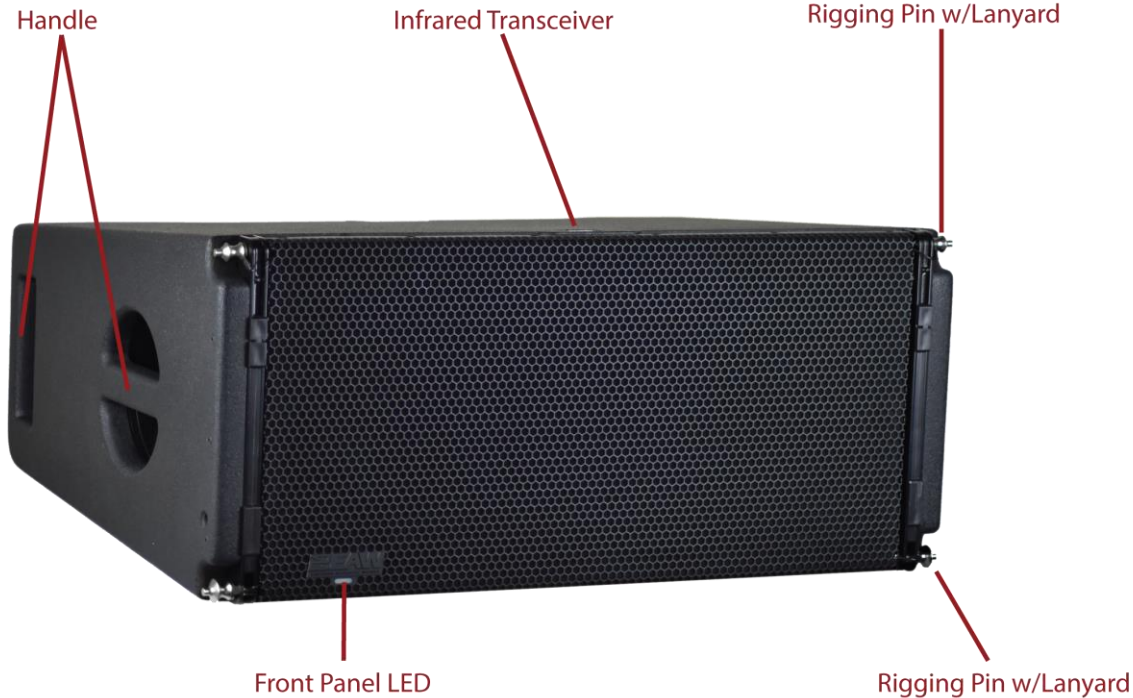

SBX218 Walkaround



SBX118 Walkaround

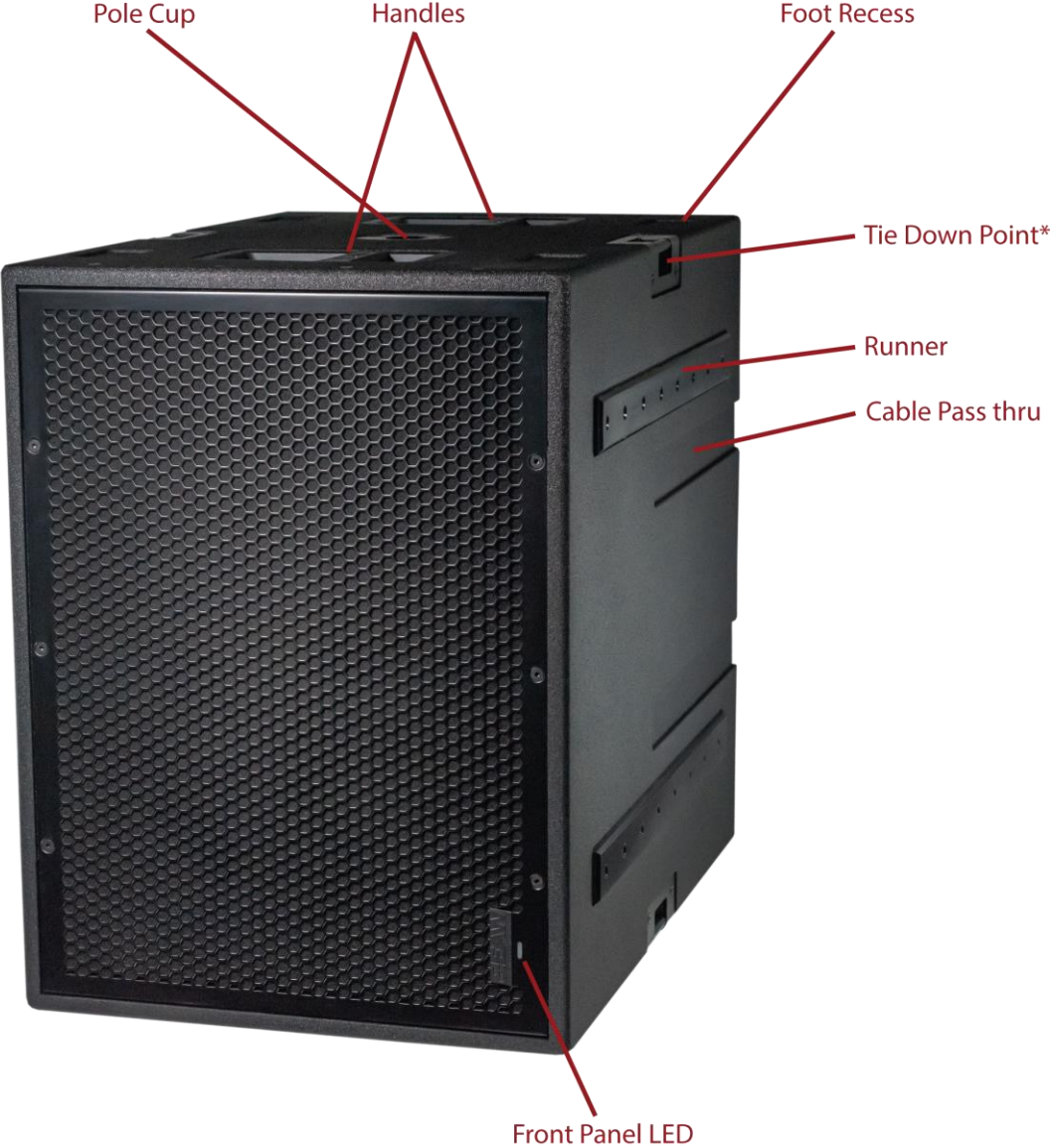

\*This will not support the weight of the subwoofer. DO NOT HANG/FLY from these points.

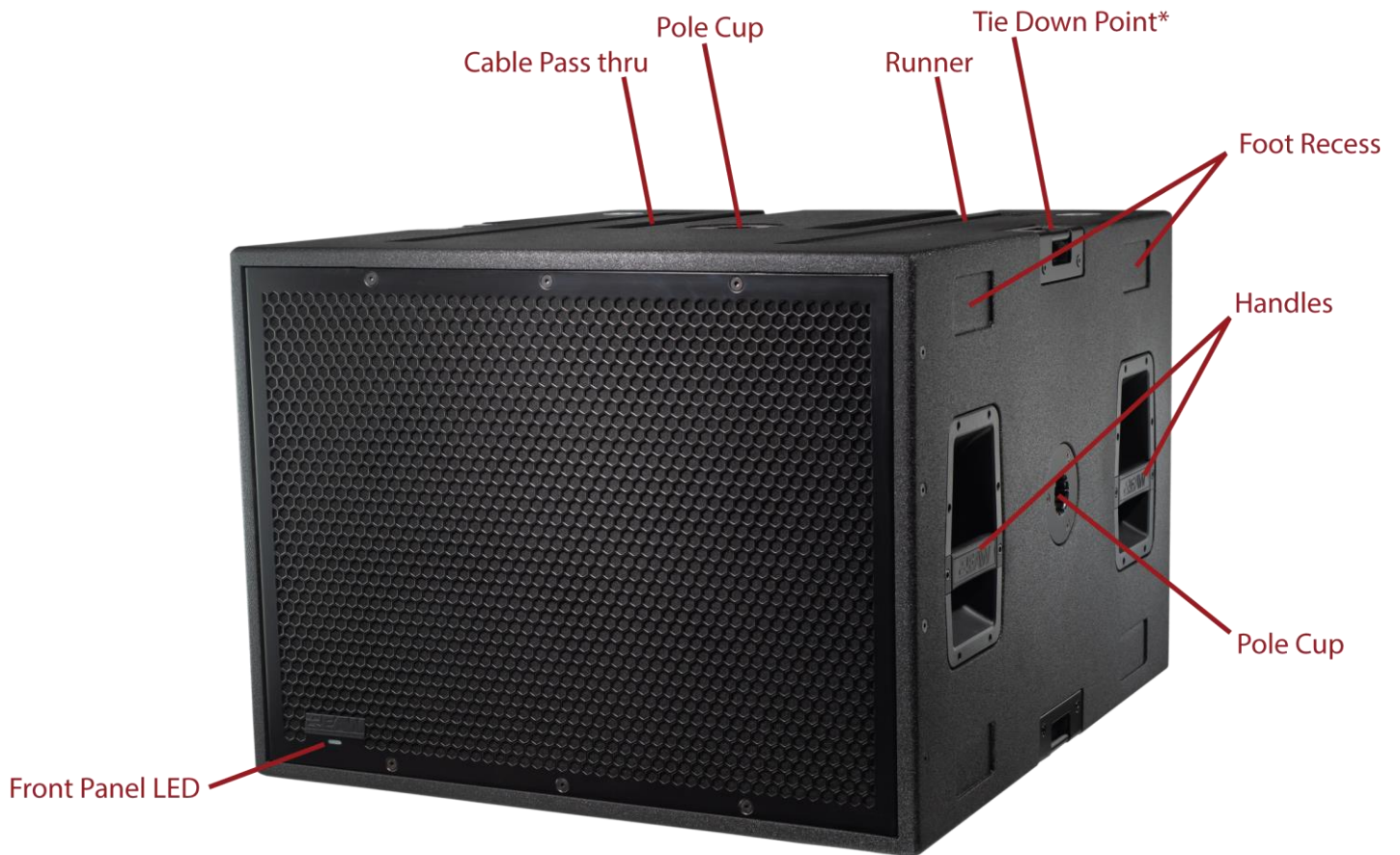

\*This will not support the weight of the subwoofer. DO NOT HANG/FLY from these points.

## Patented Infrared (IR) Transceivers [NTX Line Array]

Each time a user powers on an NTX, the modules immediately use the IR transceivers to query neighboring devices. NTX modules recognize each unit individually and as arrays, then presents that information to Resolution. The user only needs to identify where each NTX is located within the venue (left, right, etc.). The system will determine which modules are within each array, how that array is configured, and their position in the array stack.

 NTX Line Array modules have two IR Transceivers; one on the top of the array and one on the bottom of the array.

## Rigging Assemblies / Rigging Pins [NTX Line Array]

Every NTX model comes with Rigging Assemblies with connected Rigging Pins on each side.

 The NTX Rigging Pins come equipped with lanyards. Additionally, flyable NTX models ship with two extra Rigging Pins and lanyards to be used as replacements/spares.

**NOTE:** The integral mounting points on the NTX enclosures are designed to support only a single enclosure. ALWAYS SUSPEND ENCLOSURES VIA EYEBOLTS DIRECTLY FROM THE STRUCTURE. **NEVER SUSPEND ENCLOSURES FROM OTHER ENCLOSURES VIA EYEBOLTS.** The only exception to this is utilizing a flybar and the integral array rigging on the NTX210L.

Always use EAW Resolution to verify the structural integrity of the array you intend to suspend. The ONLY exception to this is with the pre-defined, pre-approved array configurations provided later in this manual.

 NTX Line Array modules have no mounting points but can be flown using the attached rigging hardware and compatible flybar assemblies.

## Handles

The built-in handles on all NTX & SBX cabinets indicate that they should always be lifted, carried and moved by at least two people.

 NEVER attempt to suspend ANY unit by the handles. Failure to follow these precautions may result in damage to the equipment, personal injury, or death.

## Rear Panel Home Screen and Menu Navigation

The NTX & SBX Series Loudspeaker's LCD Display and DSP Navigation / Edit Wheel are used to monitor the loudspeaker's status and adjust its DSP settings. Rotate the DSP Navigation / Edit Wheel to change the highlighted sub-menu or to change parameter values. Press it to select a sub-menu or to enter values.

Upon power on and initialization of the loudspeaker the Main Menu is displayed. Here the user can adjust the NTX or SBX loudspeaker output level, alignment delay settings, voicing profile and user preferences, initiate a test of the loudspeaker's output and run the Array Optimization sequence.

The network LEDs on the upper left that display during menu navigation indicate the following:

- **GRAY:** Not plugged in, or no signal on the cable (network is not active)
- **RED:** Link UP, Dante Input selected, Dante Mute is ON
- **AMBER:** Link Up, Network active



If the Home Screen is displayed, pressing or turning the DSP Navigation / Edit Wheel reveals the Main Menu.

## Level

Selecting **Level** allows adjusting to the loudspeaker's output level in 0.5 dB increments ranging from -10 dB to +10 dB. Rotating the DSP Navigation / Edit Wheel changes the level value and pressing it returns to the Main Menu. After 5 seconds have passed with no change to the Level parameter the Home Screen is displayed.

## OptiLogic (For line array items only)

NTX Series Line arrays feature Array Detection & Optimization that makes it easier and faster to sound better. The user enters a few parameters - minimum and maximum audience distances and array height - then initiates the optimization sequence.

Using integrated infrared transceivers and tilt sensors, the position and splay angle of each NTX module within the array is automatically detected. The modules are grouped accordingly, and the system's acoustical output is optimized to compensate for array size, audience geometry and throw distance. Array Optimization can be used with or without a network or software application.

From any NTX module within the array, select the OptiLogic sub-menu to show the status of the loudspeaker within the array. If the array has not already been optimized, or if the array has changed since it was last optimized, the display will indicate "Not optimized". The position of the speaker within the array is indicated. The speaker's splay angle relative to the speaker above it (**Angle**) is also show. Select **Next** to proceed with the entry of parameters needed for the optimization sequence or select **Back** to return to the Main Menu.

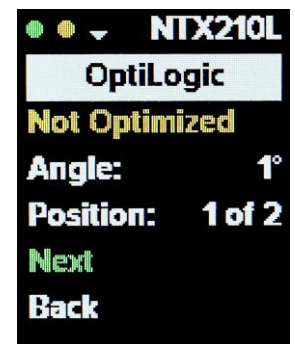

1. Enter the Array Height, measured as the distance between the ground and the Top of the upper-most NTX loudspeaker in the array.

- Rotate the DSP Navigation / Edit Wheel to highlight **Top** then press it.
- Rotate the DSP Navigation / Edit Wheel to specify the height then press it to enter the value.
- The array height parameter ranges from minimum 0 m/feet to maximum 99.0 m / 324 feet  
Select **Next** to proceed with the optimization sequence.
- Select **Back** to return to the OptiLogic sub-menu.



2. Enter the Audience parameters, measured as the distance from the point on the ground directly beneath front of the array to the Front and to the Rear of the desired coverage area.

- Rotate the DSP Navigation / Edit Wheel to highlight **Front** then press it.
- Rotate the DSP Navigation / Edit Wheel to specify the distance then press it to enter the value.
- Rotate the DSP Navigation / Edit Wheel to highlight **Rear** then press it.
- Rotate the DSP Navigation / Edit Wheel to specify the distance then press it to enter the value.

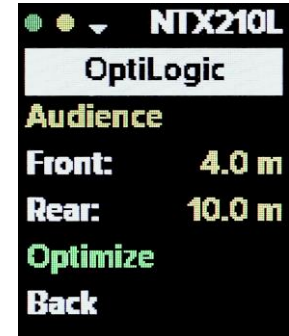

Front and Rear parameters range from minimum 0 m/feet to maximum 999.0 m / 3276 feet.  
Select **Back** to return to the Array Height sub-menu.

3. Select **Optimize** to finalize parameter entry and initiate the optimization sequence. The display will indicate "Optimizing Array..." When optimization is complete, the OptiLogic sub-menu will be shown and status will indicate "Optimized".
4. Select **Back** to return to the Main Menu or **Next** to repeat the optimization sequence using different audience and array height parameters.

Upon completion of optimization, settings for all NTX line array modules in the array are adjusted for optimum performance across the specified coverage area. Equalization adjustments are made to compensate for low frequency coupling depending upon the number of modules in the array. Additional EQ is applied to compensate for high frequency energy loss between each module and its defined coverage area.

The optimization functions independently for each discrete array employed in a multi-array system. Generally, for a stereo line array system, the optimization sequence will be performed on both sides of the system utilizing the same Audience and Array Height settings per array. For more complex venues, differing settings can be utilized but care must be taken not to overlap coverage areas from these arrays.

## Crossover

Selecting Crossover allows for optimization of the subwoofer for use with other NTX models simply by selecting "with Top".

By selecting **Variable**, it's possible to configure a specific LPF frequency to optimize the subwoofer for use with other loudspeakers.

- Rotate the DSP Navigation / Edit Wheel to highlight Var and then press it.
- Rotate the DSP Navigation / Edit Wheel to dial in the preferred frequency in 1Hz increments.
- Press DSP Navigation / Edit Wheel to enter the value.

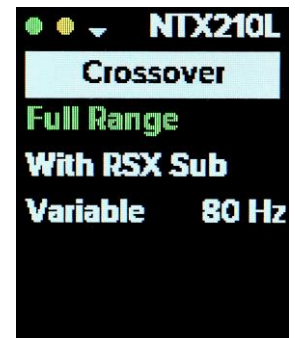



Selecting Polarity allows the user to invert the subwoofer's polarity. Norm is the default mode.

Rotating the DSP Navigation / Edit Wheel changes the selected crossover settings in real time. Pressing the DSP Navigation / Edit Wheel, or after 5 seconds have passed with no press or turn of the DSP Navigation / Edit Wheel, the Main Menu is displayed.

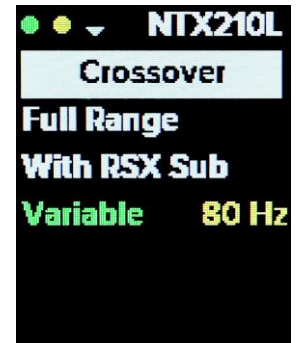

## Cardioid (For SBX118/SBX218)

Selecting Cardioid allows the user to configure the subwoofer for Cardioid functionality. In Cardioid mode, 2 or 3 subwoofers must be stacked together with one facing toward the rear. In a 2 subwoofer Cardioid setup, the top subwoofer faces to the rear. In a 3 subwoofer Cardioid setup, the middle subwoofer faces the rear.

Pressing then rotating the DSP Navigation / Edit Wheel allows for selection of 1 (normal mode / non-Cardioid), 2 or 3 (Cardioid mode) subwoofers. Once the proper configuration is selected (for 2 or 3 subwoofer Cardioid configurations) pressing then turning the DSP Navigation / Edit Wheel allows the user to identify the position of the subwoofer in the Cardioid setup (top or bottom in a 2-subwoofer setup and top, middle or bottom in a 3-subwoofer setup). Once the proper position is selected, pressing the DSP Navigation / Edit Wheel returns the user to the Main Menu. This procedure should be performed for each subwoofer in a cardioid setup.

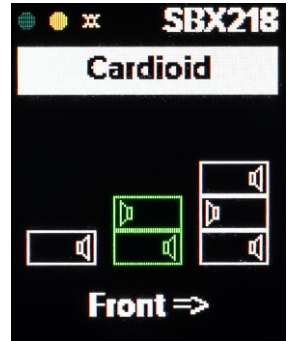

## Voicing

System optimization is further streamlined using four pre-defined voicing profiles based on feedback compiled from key touring and installation contacts. These provide a variety of tonal starting points depending on the musical style and user preference. In addition, one user-defined profile is available for selection, and can be configured using the EAW Mosaic application for iOS.

Below, the target response and a brief explanation are provided for each voicing.



### White

White represents a nominally flat voicing. It should be used when the most neutral, uncolored system response is desired.

### Grey

Compared to White, the Grey voicing provides a low-frequency boost with a gradual high-frequency roll-off.

### Blue

Blue voicing provides a more significant low-frequency boost, coupled with the same high-frequency roll-off as Grey, but with more mid-frequency attenuation.

This voicing is most suitable for high-SPL performances with significant upper-mid content. The more extensive mid- and high-frequency attenuation is sometimes useful to combat fatigue with midrange-heavy instruments, as the ear is most sensitive to this range of frequencies.

### Sapphire

Sapphire voicing combines the low-frequency boost and high-frequency attenuation of Blue, but with the addition of additional very high-frequency emphasis for additional "air" and clarity.

This voicing is especially suitable for high-quality audio playback (without the need for supplemental equalization) and was the result of feedback from several touring audio engineers.

### User

One voicing profile is reserved for the user to define and save for later recall. Using the EAW Mosaic application for iOS, the user can customize the voicing and store it to this profile. Later, loading the User voicing will recall the stored voicing profile.

This profile remains in the loudspeaker's memory until a factory reset is performed or until it is altered by a user via EAWmosaic.

Rotating the DSP Navigation / Edit Wheel changes the selected voicing profile in real time. Pressing the DSP Navigation / Edit Wheel, or after 5 seconds have passed with no press or turn of the DSP Navigation / Edit Wheel, the Main Menu is displayed.

## Delay

Selecting Delay allows adjusting to the loudspeaker's alignment delay in 1 ms increments ranging from 0 to 150 ms in 0.1 ms increments between 0 and 10 ms and in 1 ms increments above 10 ms. For reference, the equivalent distance is displayed in meters and in feet. Rotating the DSP Navigation / Edit Wheel changes the delay value, and pressing it returns to the Main Menu. After 5 seconds have passed with no change to the Delay parameter, the Home Screen is displayed.

## Output Check

Transducers and amplifier channels can quickly be checked without the need for an external noise generator and any associated cables or test equipment. Individual transducers and amplifier channels can be tested manually or via an automated sequence.



Initiating Output Check automatically or manually will cause the loudspeaker to emit pink noise. To ensure against potentially dangerous exposure to high sound pressure levels, it is recommended that all persons exposed to equipment capable of producing high sound pressure levels use hearing protectors while the equipment is in operation.

### Auto:

Using the Auto mode, a 2-second burst of pink noise is emitted first from the HF, then the LF transducer. Lastly, another 2-second pink noise is emitted from all transducers simultaneously. To initiate the Auto Output Check sequence, follow these steps.

1. Rotate the DSP Navigation / Edit Wheel to select **Auto**.
2. Press the DSP Navigation / Edit Wheel to initiate the automatic test procedure.  
*Note: Status changes from "Start" to "Stop". Press it again to terminate the test sequence at any point.*
3. A 2-second pink noise burst is emitted per transducer.  
*Note: When a channel is emitting pink noise, its status changes to indicate "On". It changes back to "Off" after the 2 second burst is complete.*
4. A 2-second pink noise burst is emitted from all transducers simultaneously.  
*Note: Status for all drivers changes to "On" during this pink noise burst. They change back to "Off" upon completion.*
5. Auto status changes to "Start" to signify the end of the Output Check cycle.

### HF: and LF:

Pink noise can be activated for manual testing of individual or combinations of transducers and their corresponding amplifier channels.

1. Rotate the DSP Navigation / Edit Wheel to select HF, MF or LF.
2. Press then turn the DSP Navigation / Edit Wheel to change the status to "On" and activate pink noise for the selected channel.
3. Press then turn the DSP Navigation / Edit Wheel to change the status to "Off" and deactivate pink noise for the selected channel.  
*Note: Pink noise can be activated for any combination of amplifier/transducer channels. Pink noise will continue to be emitted until the channel's status is manually changed to "Off" by the user or because of running the Auto Output Check sequence.*

Select **Back** to exit Output Check and return to the Main Menu.

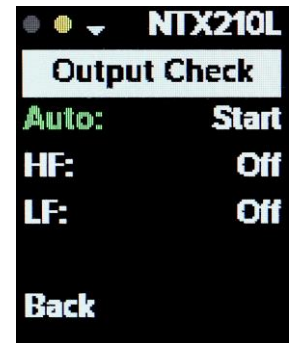

## Settings

From the Settings menu, it's possible to configure LCD display preferences, restore the loudspeaker to factory default settings, and view network address and firmware version information.

### Screen:

To accommodate aesthetically sensitive situations where the bright LCD display may be distracting, NTX & SBX provide three options for the user to optimize the LCD display behavior and brightness.

To change settings, rotate the DSP Navigation / Edit Wheel to select **Screen**.

#### *Bright*

The default setting suitable for well illuminated indoor/outdoor venues or when operating in bright sunlight. Menu navigation and parameter entry is performed with the LCD display at maximum brightness. The Home Screen is also displayed at maximum brightness.

#### *Dim*

When maximum brightness settings become too distracting such as in darker theaters or evening outdoor events, the LCD display can be dimmed.

Menu navigation and parameter entry is performed with the LCD display at reduced brightness. The Home Screen is also displayed at reduced brightness.

#### *Off*

For the most aesthetically sensitive applications, the home screen can be turned off.

### Units:

Select meters or feet as the preferred unit of measurement for height and distance parameters.

### Restore:

Factory settings can quickly and easily be restored. This is convenient for managing rental inventories or for resetting a mobile production system prior to deployment to the next venue or job site. It can also be used when troubleshooting loudspeakers exhibiting distorted audio, poor frequency response, low output, etc. Certain settings in the loudspeaker can only be accessed via EAW Resolution. These settings can be the cause of what may appear to be poor performance when the speaker is isolated on the test bench, or when compared to other units in inventory. All settings are reset to factory default when the Restore procedure is performed.

1. Rotate the DSP Navigation / Edit Wheel to select **Restore**.
2. Press the DSP Navigation / Edit Wheel and the *Restore factory defaults?* prompt appears.
3. Select *No* to return to the Settings sub-menu without changing any of the loudspeaker settings.
4. Select *Yes* to restore factory default settings and return to the Main Menu.

### About:

The About screen provides information about the loudspeaker's current input source, model number, firmware and network address details.

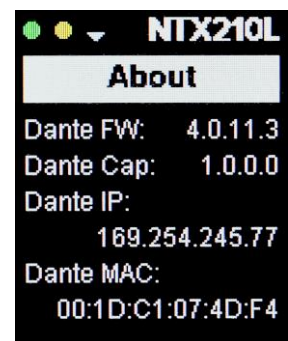

# Home Screen

After 5 seconds have passed with no turn or press of the DSP Navigation / Edit Wheel the Home Screen is displayed showing primary settings, levels and statuses at a glance.

The Control IP is the IP address assigned to the modules DSP.

Three indicators are listed below the Control IP. A & B represent the two Dante inputs, whereas C represents the filtered control port.

- **GRAY:** Not plugged in, or no signal on the cable (network is not active)
- **RED:** Active network connection with speed
  - (ie two speakers connected together but not to anything else).
  - Normally, Ethernet Green LED ON, Yellow LED OFF
- **AMBER:** Active network connection, speed is less than 1Gbps
- **GREEN:** Active network connection with 1Gbps network speed

Input will indicate whether a Dante or Analog signal is being detected.

- This can be toggled in the Resolution or changed by assigning/unassigning in Dante Controller.

The Dante IP is the IP address assigned to the Dante Card.

Under the Dante IP, is the name that has been configured for the module in Dante Controller.

*NOTE: If this is an SBX module, there will be an additional notifier for cardioid. This will indicate the current cardioid status and position of the module if configured.*

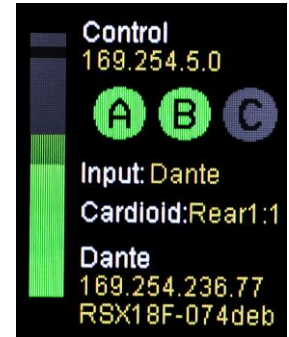
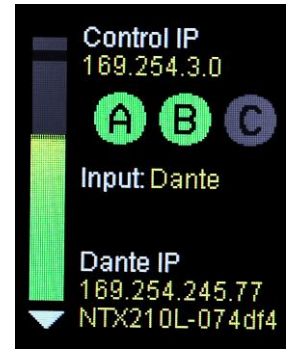

## Introduction

Dante – Digital Audio Network Through Ethernet – is an industry standard in digital audio networking, delivering unmatched audio quality, extremely flexible routing and offers significant cost savings compared to traditional analog cable runs.

NTX & SBX Series loudspeakers may be connected to any Dante-enabled audio network. As such, it is a perfect solution for connecting to a Dante-enabled mixer.

The dual Dante ports allow daisy chaining between NTX Series products.

With flawless interoperation with hundreds of Dante-enabled products, the Dante connectors truly expand the NTX & SBX Series' functionality and application-flexibility in any professional environment.

## Why use Dante?

Why use Dante? There simply isn't enough space here to explain *all* the benefits of Dante, but here's a small sampling:

- Automatic configuration
- Uncompressed low latency digital audio: >150µs
- High channel count: up to 1024 (512 x 512) channels per link
- Maximum sampling rate: 192 kHz
- Maximum bit depth: 32 bits
- Switchable and routable
- Can easily handle long distances and/or multiple locations
- Daisy-chain or use for system redundancy
- Massive cost savings

# Using EAW Resolution 2

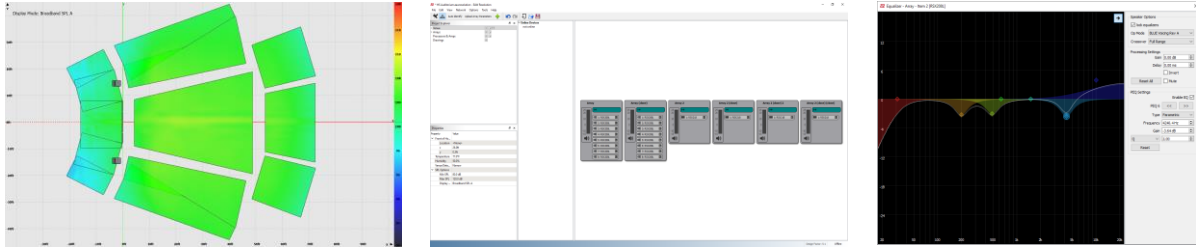

## What is Resolution 2?

EAW Resolution™ 2 is a tool to assist sound system designers and engineers to select, configure, and implement EAW loudspeaker products. Resolution™ 2 predicts *direct* sound pressure level (SPL) in a 'virtual' venue. Signal processing can be applied in software, and the resulting frequency response calculated for 'virtual microphones' throughout the model.

Additionally, Resolution™ 2 performs mechanical calculations for a given array or loudspeaker configuration to assist the user in correctly rigging their sound system.

## Why use Resolution 2?

It helps predetermine any issues that may arise, including safety, weight, angle, flybar and more.

Resolution determines coverage, allowing the user to place microphones on the surfaces and the options to choose specific passbands.

Resolution's venue view (prediction) and network view (control) work hand in hand. NTX line items coupling and HF shading may be determined by the venue model and array configuration.

It also is a great tool for pre-sales. Customers will be able to see the final setup prior to any purchase. Therefore, realistic expectations have been set for all interested parties which results in a better relationship between the buyer and seller.

Resolution 2 is free, and all future improvements and updates are free of charge as well.

## System Requirements

EAW Resolution 2 requires an IBM®-compatible PC with Windows 10® operating systems, including a standard Ethernet port to connect the computer to the network and control NTX & SBX loudspeaker modules. Though processor speed and memory size primarily impact only calculation time, the following specifications are recommended for useful operation:

	<b>MINIMUM REQUIREMENTS</b>	<b>RECOMMENDED SPECIFICATIONS</b>
<b>Processor</b>	2.2 GHz Dual Core Processor	2.8 GHz Quad Core Processor
<b>Memory</b>	2 GB RAM	8 GB RAM
<b>Screen Resolution</b>	1024 x 768 display resolution	1920 x 1080 display resolution
<b>Operating System</b>	Windows 10	
<b>Storage</b>	1 GB available HD space	

*\*\*Currently, Resolution does not support 4k screens\*\**

# Rigging Instructions

The assembly of two NTX modules can be done following the steps below:

- On the first module, remove the pins [3], raise the retractable brackets [2] and fasten them to the new position using the pins [3].
- Remove the pins [1] from the second module, place it on top of the first module, inserting the brackets [2] as shown. Then fasten the front side of the two modules using the pins [1] of the second module.
- On the back, remove the pins [5] from the rear brackets [4]. Then insert the movable arm [6] of the second module into the bracket [4] of the first module. The next page shows in detail the fastening of the angle on the rear between the two modules.

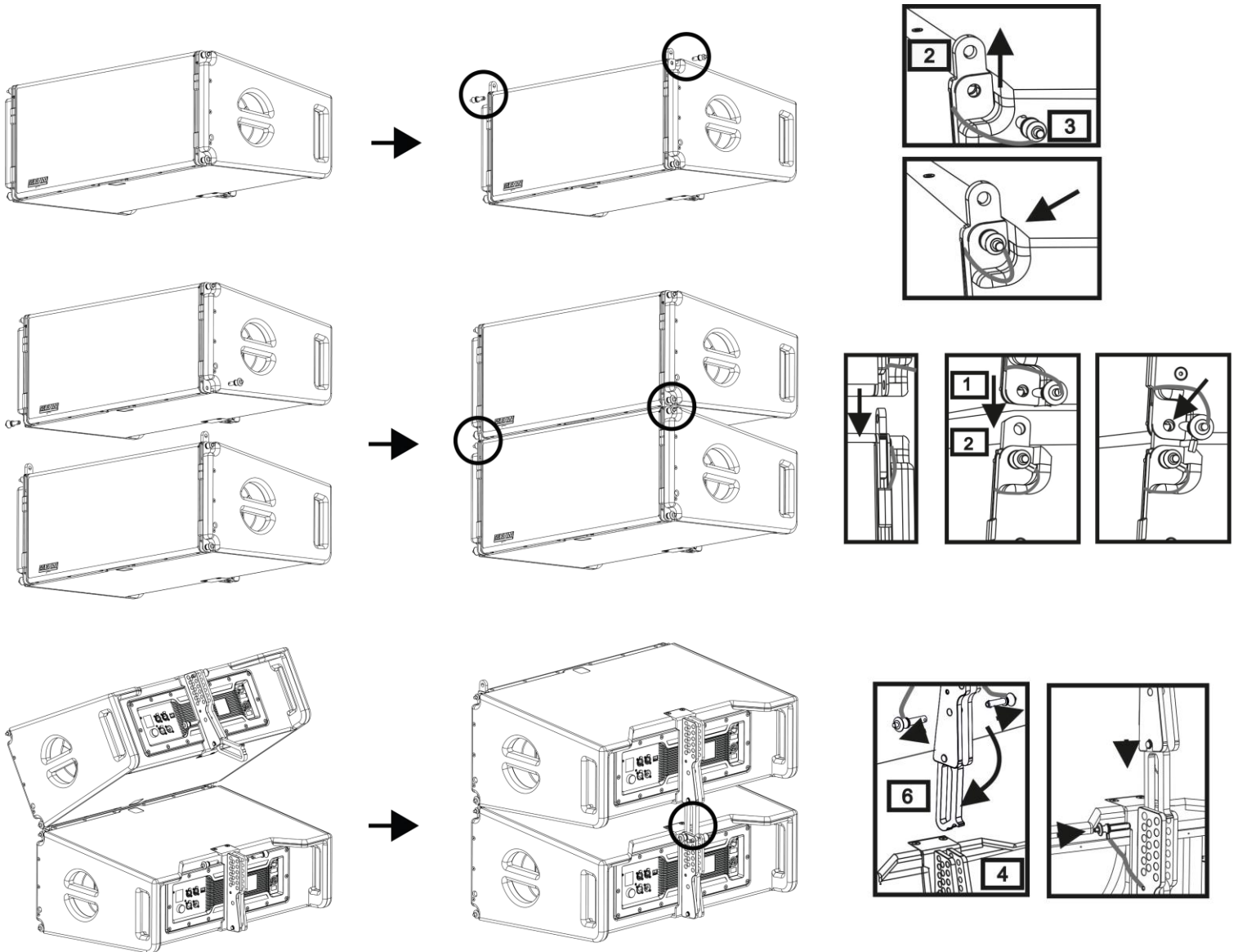

The below example explains two cases in which you want to set a specified angle between two modules using the rear rigging. Before carrying out any other operation, make sure that once the movable arm is inserted [6], the hole of the chosen angle is contained inside the loop as shown.

- **FLOWN CASE:** insert only one pin in the hole on the chosen angle. The second pin can be housed in the “PIN HOLDER” hole. Note that this type of configuration during the assembly allows changing the chosen angle simply by moving the respective pin (with the movable arm inserted).
- **STACKED CASE:** once the pin [5] is inserted into the hole of the chosen angle, lift module B as far as the movable arm [6] allows. At this point, insert the second pin into the “ANGLE LOCK” position and release module B. This way, module B is completely blocked by the two pins on the rear.

After assembly is completed, always make sure that all the pins have been completely inserted and are well locked.



*Rear Rigging Assembly Plates*



## Accessories

For quick installation, the following optional accessories can be purchased:

- Fly-bar for the flown and stacked use for line arrays of NTX210L modules.
- A cart to transport up to 4 NTX210L modules.

### NTX210L Flybar

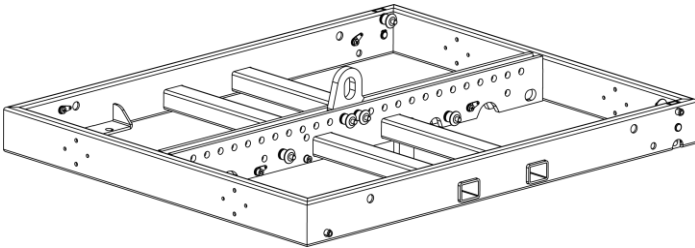

NTX Flybar using one shackle/pick point

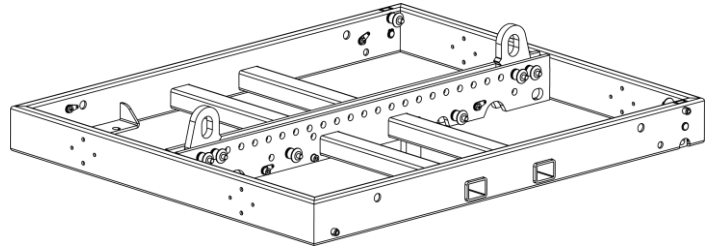

NTX Flybar using two shackles/pick points



Maximum number of NTX210L that may be flown with the NTX flybar is 8 units with a 10:1 design factor. Always confirm configurations are safe using EAW Resolution 2 software.



Maximum number of NTX210L that may be ground stacked without the flybar is one. They flybar is required to ground stack more than one NTX cabinet. Using the NTX flybar, the maximum number of ground stacked items is 8. Always confirm configurations are safe using EAW Resolution 2 software.

The assembly of an NTX module to an NTX Flybar can be done following the steps below:

- Connect to single or dual shackles and raise shackle enough to fit NTX module underneath comfortably.
- Raise rigging ears on NTX and align to flybar holes.
- Insert front rigging pins on both sides.
- Align and lock into place rigging plates on flybar to rear rigging assembly on NTX module.

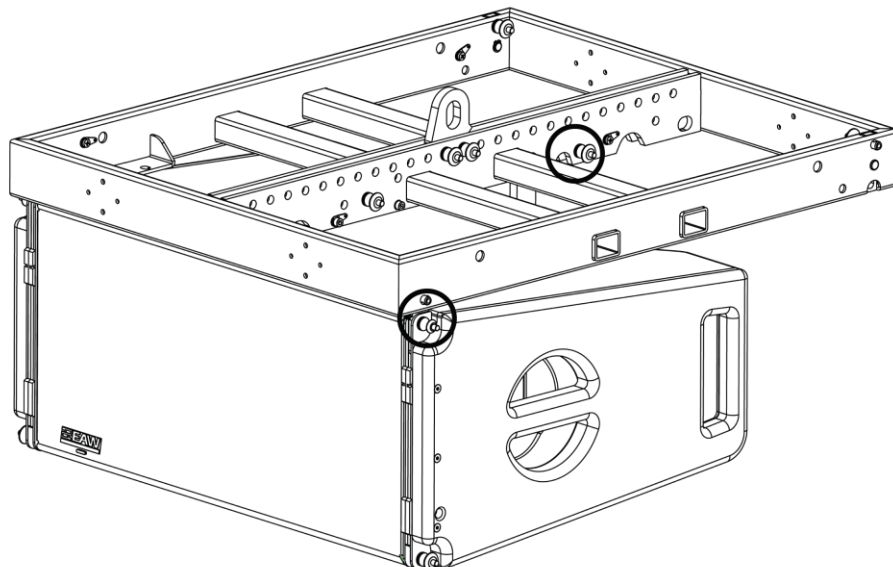

Ground stacking of an NTX module is possible using the NTX Flybar by following the steps below:

- Place flybar upside down with rigging ears facing up on flat surface or on top of an SBX118 subwoofer.
- Place NTX on top of flybar, aligning with rigging ears.
- Insert front rigging pins on both sides.
- Align and lock into place rigging plates on flybar to rear rigging assembly on NTX module.

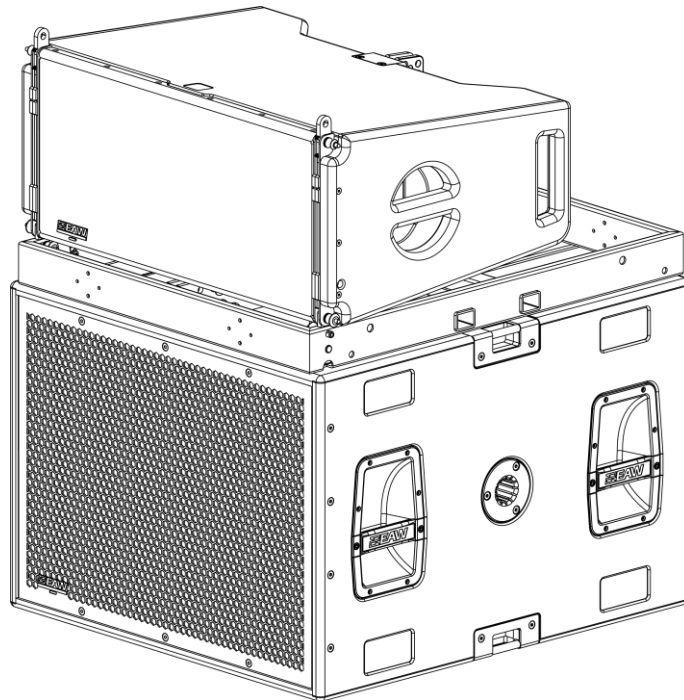

Carts, casters, and caster pallets are available for NTX Series products:

- The NTX Cart can transport up to 4x NTX line array items.

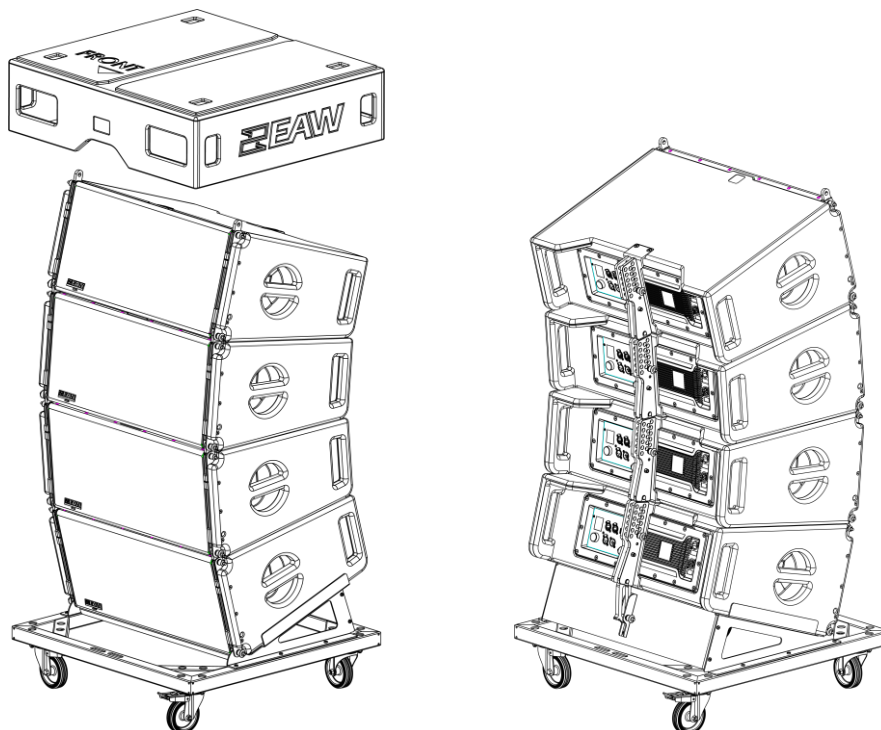

- SBX218 & SBX118 caster pallets may transport up to 2 subwoofers.

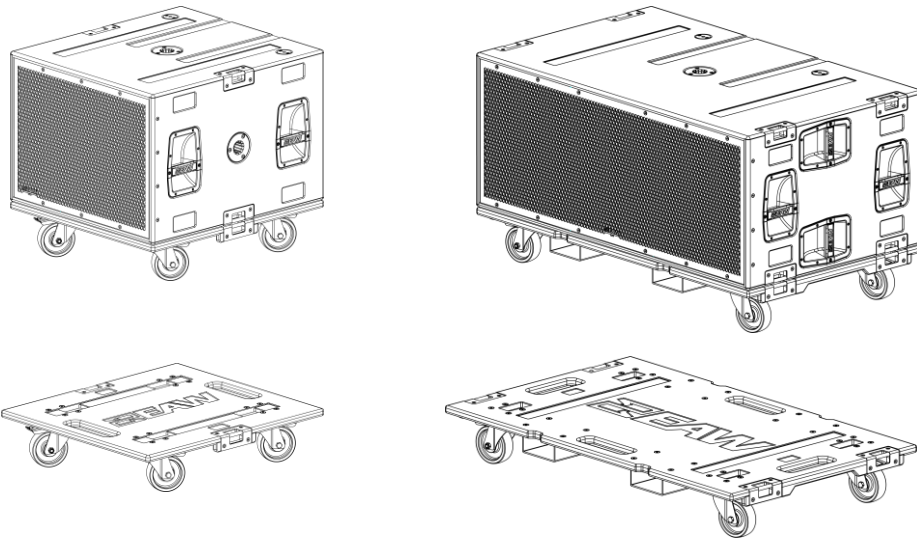

- Caster kits may be utilized directly on SBX subwoofers.

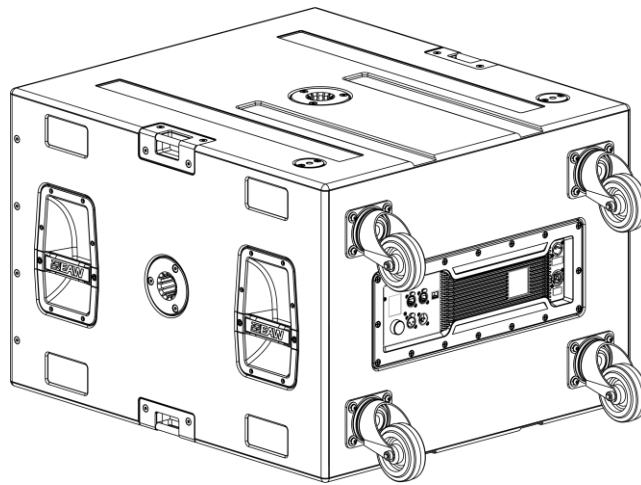

# Service, Inspection & Maintenance

## General Service

All components in the NTX & SBX systems are designed to withstand the most rigorous and demanding environments. Through regular operation it may still be necessary to replace acoustical, electronic and mechanical components.

## Contacting EAW

We have attempted to make this manual and the as thorough as possible. However, feel free to contact us with any further questions or comments for topics not covered.

## Operating Questions

EAW Applications Engineering & Support

**Tel** 508-266-6334

**Tel** 800-992-5013 (USA only)

**E-mail** Design@eaw.com

## Service Information

EAW Service Department

One Main Street Building 13

Whitinsville, MA 01588 USA

**Tel** 508-234-6158

**Tel** 800-992-5013 (USA only)

**E-mail** Parts@eaw.com



**EAW**

**Eastern Acoustic Works**

One Main Street | Whitinsville, MA 01588 | USA

tel 800 992 5013 / +1 508 234 6158

[www.eaw.com](http://www.eaw.com)

©2021 Eastern Acoustic Works

All rights reserved. Products are not drawn to scale.

All terms, conditions, and specifications subject to change without notice.