

Z4MK4 & Z8MK4 ZONE MIXERS

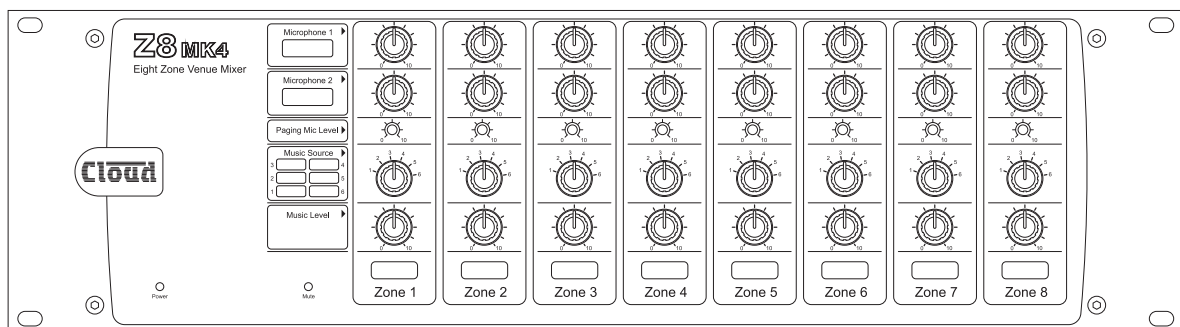
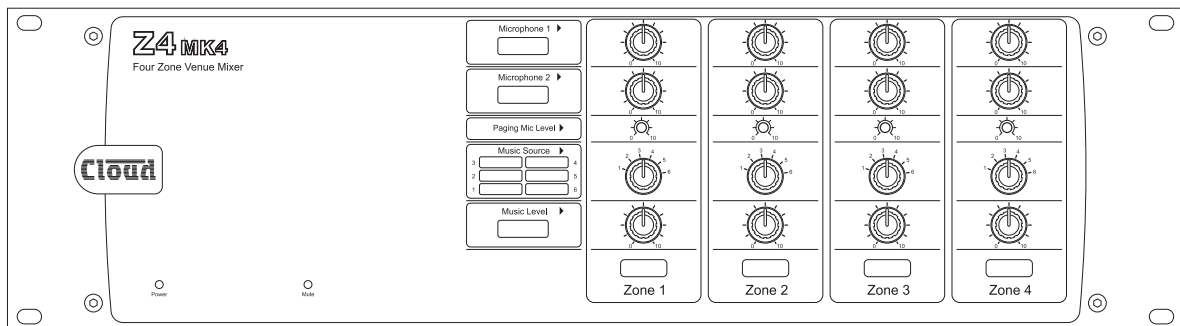

Installation and User Guide

Contents

Safety Information	4
Important Safety Instructions	4
Read these instructions	4
Conformities	4
OVERVIEW	5
Introduction	5
Scope of this manual	5
What's in the box	5
Main Features	5
Optional System Components	6
LM-2 Mic/line input module with remote music control	6
RL-1 Series Remote Music Level Control	6
RSL-6 Series Remote Music Level/source Control	6
PM Series paging microphones	7
PM1 paging microphone	7
Block Diagram	7
Description of front panel	8
Description of rear panel	9
INSTALLATION	10
Hardware Considerations	10
Power Supply	10
Fuses and ratings	10
System Connections	10
Music Sources	10
Zone outputs	11
Microphone inputs	12
Facility Ports	12
Paging System connections	13
Music Control	15
SETTING UP & OPERATION	17
Music Inputs	17
Gain & level	17
Local/remote control	17
Microphone Inputs	17
Phantom Power	17
Gain & level	17
EQ	17
High-pass filter	17
Paging mic input	18
Phantom Power	18
Gain & level	18
EQ & high-pass filter	18

Cloud Digital Paging Mics.....	18
Network termination	18
Zone Offset	19
Zone Outputs.....	19
EQ.....	19
Priorities	19
Mic 1/Mic 2 priority	19
Paging mic priority.....	19
Override of Paging mic priority during Music Mute.....	20
Line 6 priority.....	20
Microphone priority over input at Facility Port	20
OPTIONS AND ADDITIONAL INFORMATION.....	21
LM-2 active input modules – general considerations	21
Connecting multiple LM-2s	21
Using the Facility Ports as auxiliary zone inputs	21
Disabling the Facility Port Noise Gate	21
RL-1 Series and RSL-6 Series remote control plates – general considerations	22
Control of music source and level via external DC.....	22
Fitting loudspeaker EQ cards	23
APPENDIX	24
Application example 1	24
Application example 2	25
PCB jumper location and settings.....	26
PSU capability and optional device current consumption	28
Ground loops	28
EMC considerations	28
Technical Specifications	29

Safety Information

Important Safety Instructions

Read these instructions.

- Keep these instructions.
- Heed all warnings.
- Follow all instructions.
- Do not use this apparatus near water.
- Clean only with dry cloth.
- Do not block any ventilation openings. Install in accordance with the manufacturer's instructions.
- Do not install near any heat sources such as radiators, heat registers, stoves, or other apparatus (including amplifiers) that produce heat.
- Do not defeat the safety purpose of the polarized or grounding-type plug. A polarized plug has two blades with one wider than the other. A grounding type plug has two blades and a third grounding prong. The wide blade or the third prong are provided for your safety. If the provided plug does not fit into your outlet, consult an electrician for replacement of the obsolete outlet.
- Protect the power cord from being walked on or pinched particularly at plugs, convenience receptacles, and the point where they exit from the apparatus.
- Only use attachments/accessories specified by the manufacturer.
- Use only with the cart, stand, tripod, bracket, or table specified by the manufacturer, or sold with the apparatus. When a cart is used, use caution when moving the cart/apparatus combination to avoid injury from tip-over.
- Unplug this apparatus during lightning storms or when unused for long periods of time.
- Refer all servicing to qualified service personnel. Servicing is required when the apparatus has been damaged in any way, such as power-supply cord or plug is damaged, liquid has been spilled or objects have fallen into the apparatus, the apparatus has been exposed to rain or moisture, does not operate normally, or has been dropped.

WARNING:

To reduce the risk of fire or electric shock, do not expose this appliance to rain or moisture.

CAUTION:

Use of controls or adjustments or performance of procedures other than those specified may result in hazardous radiation exposure.



WARNING: SHOCK HAZARD - DO NOT OPEN

AVIS: RISQUE DE CHOQUE ÉLECTRIQUE - NE PAS OUVRIR

 The lightning flash with the arrowhead symbol within an equilateral triangle, is intended to alert you to the presence of uninsulated dangerous voltages within the product's enclosure that may be of sufficient magnitude to constitute a risk of electric shock.

 The exclamation point within an equilateral triangle is intended to alert the user to the presence of important operating and maintenance (servicing) instructions in the literature accompanying the appliance.

Un point d'exclamation dans un triangle équilatéral est destiné à alerter l'utilisateur de la présence d'instructions importantes sur le fonctionnement et l'entretien (la réparation) dans la documentation accompagnant l'appareil.

 The mains plug is used as the disconnect device and it should remain readily accessible during intended use. In order to electrically isolate the apparatus from the mains, the mains plug should be completely removed from the mains outlet socket.

La prise du secteur ne doit pas être obstruée ou doit être facilement accessible pendant son utilisation. Pour être complètement déconnecté de l'alimentation d'entrée, la prise doit être débranchée du secteur.



Meaning of the label: Evaluation for apparatus only based on temperate climate condition, therefore it's the only operating condition applied for the equipment. There may be some potential safety hazard if the equipment is used in tropical climate region.

L'évaluation pour les appareils est basée dans une condition climatique tempérée, donc c'est la seule condition de fonctionnement à appliquer pour l'appareil. Il peut y avoir un risque potentiel pour la sécurité si l'équipement est utilisé dans une région climatique tropical.



Meaning of the label: Evaluation for apparatus only based on altitude not exceeding 2000 m, therefore it's the only operating condition applied for the equipment. There may be some potential safety hazard if the equipment is used at altitude above 2000 m.

L'évaluation pour les appareils est basée uniquement sur une altitude inférieure à 2000 m, donc c'est la seule condition de fonctionnement à appliquer pour l'appareil. Il peut y avoir un risque potentiel pour la sécurité si l'équipement est utilisé avec une altitude au-dessus de 2000 m.

Conformities

This product conforms to the following European EMC Standards: **BS EN 55103-1:2009, BS EN 55103-2:2009**



This product has been tested for use in commercial and light industrial environments. If the unit is used in controlled EMC environments, the urban outdoors, heavy industrial environments or close to railways, transmitters, overhead power lines, etc., the performance of the unit may be degraded.

The product conforms to the following European electrical safety standard: **BS EN 60065:2012**

OVERVIEW

Introduction

Thank you for purchasing this Cloud Zone Mixer. We are confident that you will be pleased with its performance, features, flexibility and reliability.

The Cloud Z8MK4 and Z4MK4 are versatile analogue multizone audio mixers. They are intended to form part of permanent sound systems in pubs, bars, restaurants, hotels, offices, factories and other areas, where multiple audio sources (background music, TV sound, etc.) are in use and need to be easily combined with announcements and/or paging in one or more zones. They are compatible with Cloud PM Series paging microphones and are also designed to interface with most third-party paging microphones conforming to industry standards.

Scope of this manual:

This manual provides a comprehensive guide to the features and functionality of the Cloud Z8MK4 and Z4MK4 Zone Mixers. The two models are identical in facilities and features, and differ only in the number of zones they support:

Model Z8MK4 – eight output zones

Model Z4MK4 – four output zones

Please read through the manual to become fully acquainted with the numerous configuration and control functions the units offer.

The manual is arranged as follows:

- **Overview** – introduction to the Zone Mixers and their options.
- **Installation** – wiring the Zone Mixers in a practical situation.
- **Setting Up & Operation** – setting the system up and user instructions.
- **Options and Additional Information** – additional information about system options.
- **Appendix** – additional technical information. Includes technical specifications.

The Z8MK4/Z4MK4 manual includes full details of the optional LM-2 remote input module. Basic information on interfacing Cloud PM Series paging microphones and connecting the RL-1 and RSL-6 remote control plates is also provided. This information is also supplied with each optional item.

Thank you again for placing your confidence in Cloud products.

What's in the box

Unpack the Z8MK4 or Z4MK4 and its accessories with care. It is always a good idea to store all packaging (if practical), in case you ever need to return the unit to your Cloud dealer for any reason.

As well as this manual, the shipping carton should contain the items listed below. Please contact your Cloud dealer immediately if any of them are missing or damaged.

- Cloud Z8MK4 or Z4MK4 Zone Mixer
- IEC mains lead (AC cord) with moulded plug appropriate to the territory
- Set of mating connectors for all rear panel screw-terminal connectors

Main Features

- 4 balanced stereo line inputs
- 2 unbalanced stereo line inputs
- 8 (Z8MK4) or 4 (Z4MK4) balanced mono line outputs
- 2 microphone inputs (balanced), phantom power selectable
- Separate paging mic input with contact closure zone selection
- Cloud CDPM/PM Digital Paging Interface, with configurable Zone offset
- Per-zone facility port for optional remote mic/line input module
- Mic routing to all zones with programmable override logic
- Per-zone front panel control of music level, music source and mic level
- Supports per-zone remote control of music level and source
- HF & LF EQ adjustment for each mic input and for music in each zone music output
- Preset gain trim control for each mic and music input
- Line input 6 may have priority over other music inputs
- Accepts plug-in EQ cards to suit various installed-audio loudspeakers
- External Music Mute input for interfacing with emergency systems
- 3U 19" rack-mounting unit

Optional System Components

The following components may form part of the audio system and may be ordered separately if required. They may also be retrofitted to a system at a later time. Separate datasheets are available for each of the individual components; download them at www.cloud.co.uk.

LM-2 Mic/line input module with remote music control

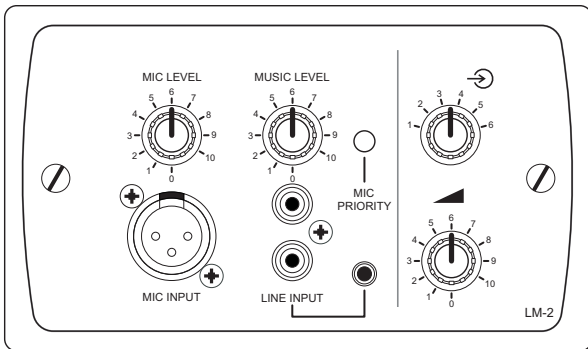

The LM-2 is an active input module which allows a microphone and a stereo line input to be connected to the Zone Mixer in a remote location. The faceplate has both phonos and a 3.5 mm jack socket for connection of the line input, and provides a convenient access point for the connection of a DJ mixer, laptop, MP3 player or similar. Mic and line inputs have separate level controls. A **MIC PRIORITY** button activates the Zone Mixer's priority circuitry; when enabled, a microphone signal (post level control) from the LM-2 will reduce the music level in the zone where it is installed. Changing a rear jumper alters the priority operation so that the mixed mic and line signals from the module cause the mixer's line input selected to the Zone to be fully muted.

The module also includes the functions of the RSL-6 Remote Control Plate (see opposite), permitting control of zone music level and source.

The LM-2 connects to one of the unit's Facility Ports via screened Cat 5 cable, and the remote inputs are fed to that zone only. The mixer's Mic inputs remain available. Multiple LM-2s (in the same zone) may be daisy-chained to provide mic inputs in more than one position. The LM-2 is available in sizes to suit UK, US and German electrical back boxes; a choice of finishes is also available. See "Connecting an LM-2 remote input module" on page 12 and "LM-2 active input modules – general considerations" on page 21 for more information.

RL-1 Series Remote Music Level Control

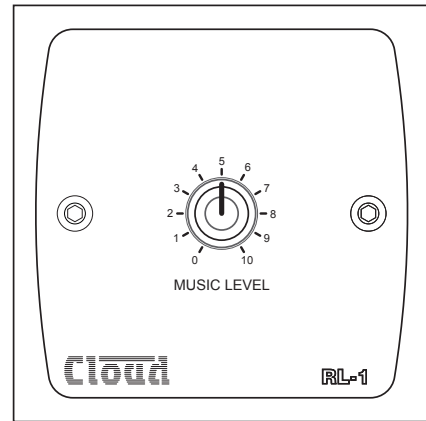

The RL-1 Series is a range of small plates with a single control for locally adjusting the music level in a zone. They connect to one of the mixer's **REMOTE SOURCE + LEVEL** ports. See "Connecting an RL-1 Series remote control plate" on page 15 and "RL-1 Series and RSL-6 Series remote control plates – general considerations" on page 22 for more information.

RSL-6 Series Remote Music Level/source Control

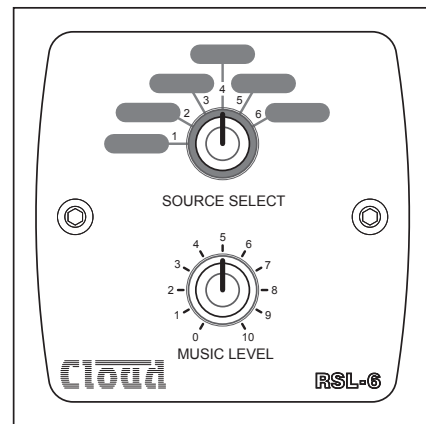

The RSL-6 Series is a range of plates of the same size as the RL-1s; they connect in a similar way. They allow local music source selection as well as music level control. See "Connecting an RSL-6 Series remote control plate" on page 16 and "RL-1 Series and RSL-6 Series remote control plates – general considerations" on page 22 for more information.

PM Series paging microphones

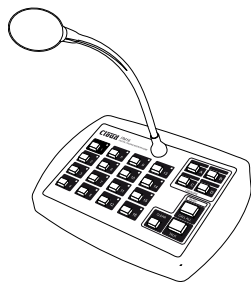

Cloud PM paging microphones may be connected directly to the Z8MK4 and Z4MK4. Models are available which can address 1 to 16 zones. Clearly, not all zones on the 'higher' models can be addressed with only one zone mixer. See "Paging System connections" on page 13 for more information.

PMI paging microphone

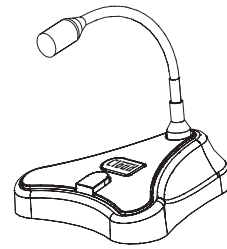

The Cloud PMI paging microphone is also compatible with the Z8MK4 and Z4MK4. It is a much simpler unit which addresses only one zone. See "Connecting a PMI paging mic" on page 14 for more information.

Block Diagram

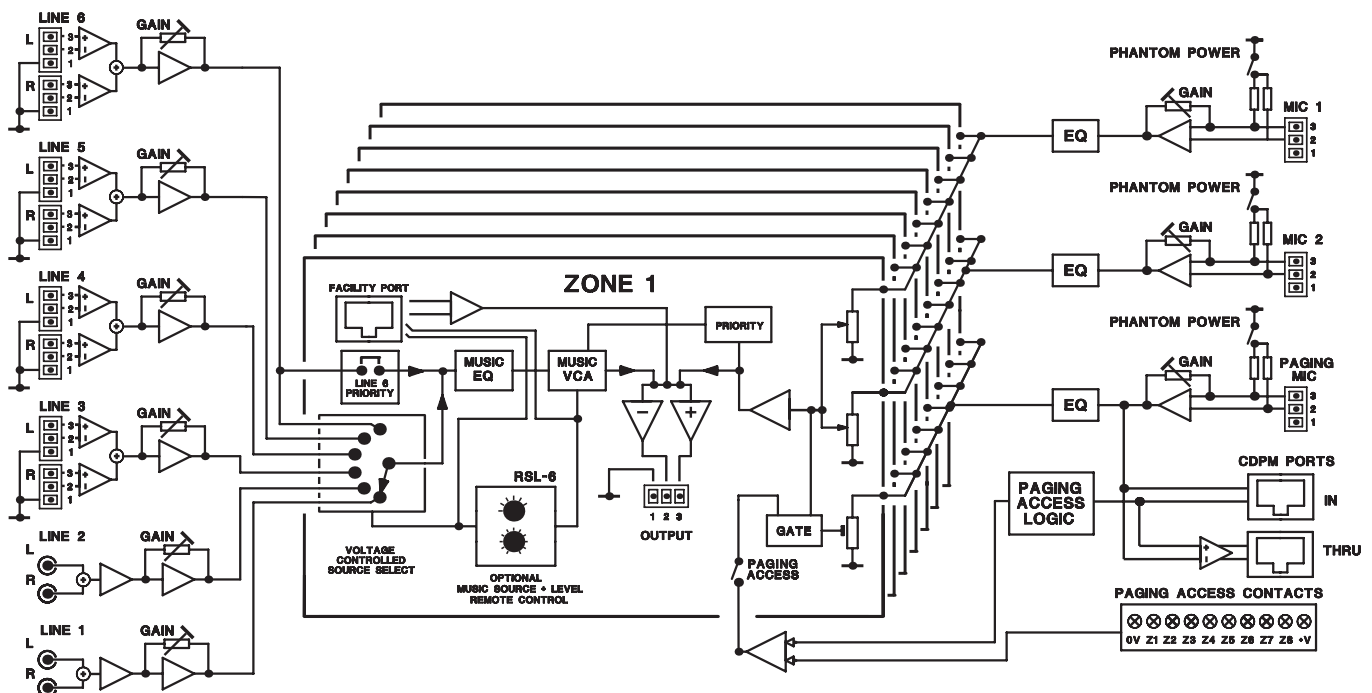

The simplified block diagram above illustrates the basic signal architecture of the Z8MK4. Only the routing and logic for one zone output is shown. The architecture of the Z4MK4 is identical, the only difference being the number of zone outputs.

Description of front panel

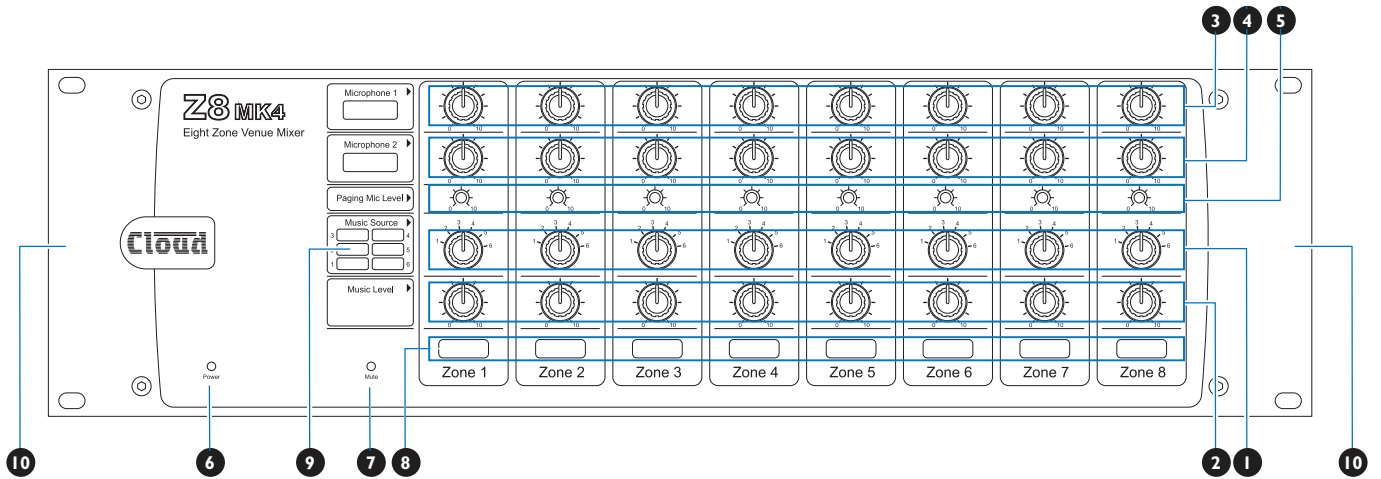

Note - The front panel of the Z8MK4 is shown above. Note that the Z4MK4 is identical, except that it only has controls for Zones 1 - 4.

1. **MUSIC SOURCE** – 6-way rotary switch selecting which Line Input (1 to 6) will be the music source for each zone. See page 17.
2. **MUSIC LEVEL** – adjusts the music level in each zone. See page 17.
3. **MICROPHONE 1** – adjusts the level of the microphone connected at Mic 1 input in each zone. See page 17.
4. **MICROPHONE 2** – adjusts the level of the microphone connected at Mic 2 input in each zone. See page 17.
5. **PAGING MIC LEVEL** – adjusts the level of the microphone connected at the Paging Mic input in each zone. This is a preset control and is intended to be set on installation and not readjusted by the user. See page 18.
6. **POWER** – green LED; confirms unit is powered.
7. **MUTE** – red LED which illuminates when an external Music Mute command is applied (i.e., from fire control panel, etc.) See page 16.
8. **Zone IDs** – a space is provided below each zone's controls for printed labels identifying the zone by name.
9. **Source IDs** – a space is provided beside Zone 1's source select control for printed labels identifying each music source by name.
10. **Rack mounting ears** – the unit may be rack-mounted in a standard 19" equipment rack. It requires 3U of rack height. See page 10.

Description of rear panel

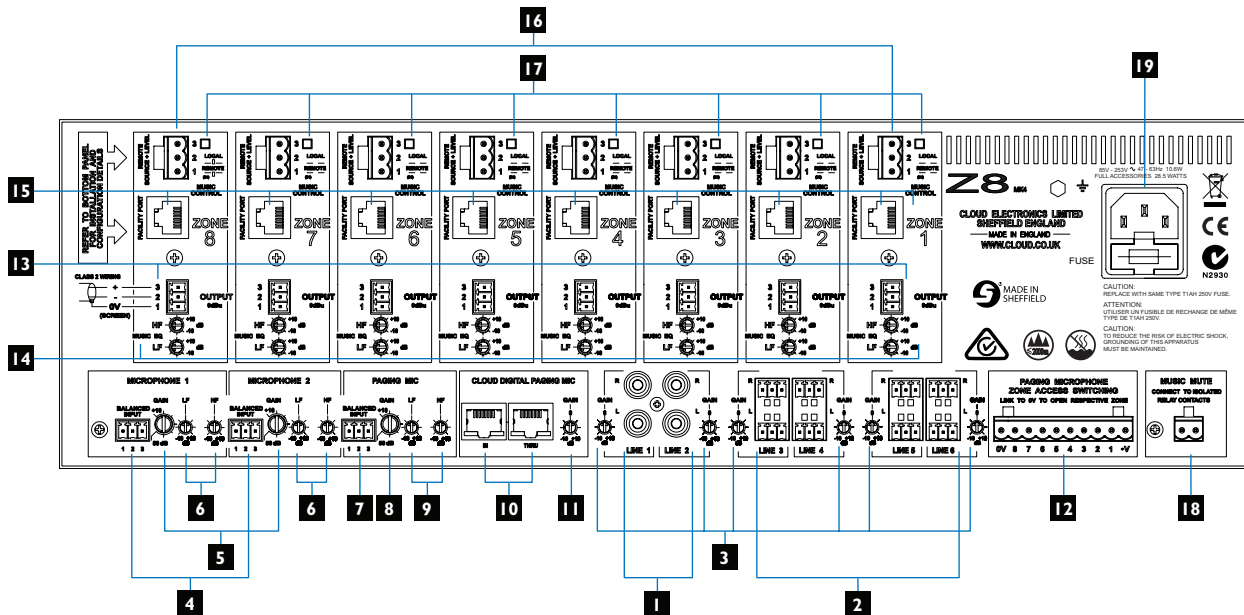

Note - The rear panel of the Z8MK4 is shown above. Note that the Z4MK4 is identical, except that it only has output connections for Zones 1 - 4.

1. **LINE 1 and 2** – two pairs of RCA (phono) sockets for connection of ZONE of music sources with unbalanced outputs. Inputs are stereo, summed internally to mono. See “Music Sources” on page 10.
2. **LINE 3 to 6** – four 3-pin 3.5 mm-pitch screw-terminal connectors for connection of music sources with balanced outputs. Inputs are stereo, summed internally to mono. See “Music Sources” on page 10.
3. **GAIN** – preset trim control for each line input, providing +/-10 dB of gain adjustment for input level matching. See page 17.
4. **MICROPHONE 1 and 2** – 2 balanced microphone inputs on 3-pin 3.5 mm-pitch screw-terminal connectors. See page 11.
5. **GAIN** – preset mic gain control for each microphone input, gain range 10 to 50 dB. See page 17.
6. **LF and HF** – preset EQ controls for each microphone input. See page 17.
7. **PAGING MIC** – dedicated balanced input (3-pin 3.5 mm-pitch screw-terminal connector) for paging mic. See page 13.
8. **GAIN** – preset gain control for paging mic input; as [5]. See page 18.
9. **HF and LF** – paging mic EQ; as [6]. See page 19.
10. **CLOUD DIGITAL PAGING MIC** – two RJ45 sockets (**IN** and **THRU**) for direct connection of Cloud PM and CDPM Series digital paging microphones. See “Cloud Digital Paging Mics” on page 18.
11. **GAIN** – preset gain trim control for digital paging mic: provides +/-10 dB of adjustment.
12. **PAGING MICROPHONE ZONE ACCESS SWITCHING** – 10-pin (Z8MK4) or 6-pin (Z4MK4) 5 mm-pitch screw-terminal connector for contact-closure paging access, per-zone. See “Paging System connections” on page 13.
13. **OUTPUTS** – 8 balanced outputs* for each zone on 3-pin 3.5 mm-pitch screw-terminal connector. See page 19.
14. **MUSIC EQ** – HF & LF EQ adjustment of music signal in zone. See page “EQ” on page 17.
15. **FACILITY PORT** – 8-pin RJ45 per-zone, for connection of remote input modules and other functions. See page 12.
16. **REMOTE SOURCE + LEVEL** ports – 3-pin 5 mm-pitch screw terminal connector per-zone, for connection of RL-1/ RSL-6 remote control plates. See page 15.
17. **MUSIC CONTROL** – switches determining whether front panel music source and level controls will remain active when remote control plates are connected (per-zone). See page 15.
18. **MUSIC MUTE** – 2-pin 5 mm-pitch screw terminal connector for connection of external emergency muting relay (e.g., fire control panel). See page 16.
19. **Mains** – Fused IEC receptacle for AC mains (includes storage for spare fuse). See page 10.

* Only 4 zone outputs on Model Z4MK4 (Items [13] to [17])

INSTALLATION

Hardware Considerations

The Z8MK4 and Z4MK4 Zone Mixers are built in 3U-high 19" rack mount enclosures. It is recommended that the Zone Mixer is installed in a 19" rack wherever possible. The units are approx. 160 mm deep, but 250 mm of rack depth should be available to allow for rear connectors and cabling.

The Z8MK4 and Z4MK4 have low power consumption and there are no thermal considerations other than ensuring that the ventilation grilles are not obstructed once the mixer is installed. The ventilation grilles are at the rear (immediately above the AC input connector); in the bottom panel (behind the AC mains switch), and in the left-hand side panel. Other equipment may be installed above or below the Z8MK4/Z4MK4 within this constraint.

The choice of location will be dictated by the specifics of the system and building layout. It is recommended that wherever possible, the Z8MK4/Z4MK4 should be mounted in an equipment rack along with as many of the music sources (CD players, music servers, TV receiver boxes, etc.) and audio power amplifiers (driving the zone loudspeakers) as practical.

When deciding the Zone Mixer's location, bear in mind that access to it will probably be required even if a full complement of remote controls is being fitted as part of the system, as some adjustments can only be made on the mixer itself.

Power Supply

The Z8MK4 and Z4MK4 are fitted with a Universal power supply which can operate on mains voltages from 85 to 253 V. An IEC mains cable with a plug appropriate for your country is supplied. The units' power consumptions are 10.6 W (Z8MK4) and 6.5 W (Z4MK4), with no accessories connected.

Fuses and ratings

The only user-accessible fuse is an AC mains fuse in the IEC connector housing. **Only replace a fuse with one of exactly the same type.** The fuse rating is 1 A; the type is a T1A, size 20 x 5 mm, with high breaking capacity.

The fuseholder may be accessed by prising the cover below the connector open, using a small screwdriver. The holder has an extra cavity for storing a spare fuse; note that the "active" fuse is that in the inner cavity.

System Connections

Music Sources

Connect the system's various music sources to **LINE 1** to **LINE 6**. Line Inputs 1 and 2 are unbalanced, on standard RCA jacks (phono sockets), while Line Inputs 3 to 6 are balanced, on 3-pin 3.5 mm-pitch screw-terminal connectors. All six inputs are stereo, with separate L and R connectors. The sensitivity range available should allow most standard items of audio equipment such as computers/tablets, music servers and media receivers, etc., to operate at a satisfactory level.

Unbalanced sources:

Source equipment with stereo unbalanced outputs may be connected directly to Line Inputs 1 or 2, and as long as the source is adjacent to the Zone Mixer, normal phono-phono (or 3.5 mm jack-to-phono leads) can be used. Always avoid using pre-made leads of an unnecessary length.

If it is necessary to connect an item of source equipment with a balanced output to Line Inputs 1 or 2, the ideal method is to use a balancing transformer between the source and the unbalanced input. Suitable audio transformers, which should have a ratio of 1:1, are readily available from major audio component suppliers. The transformer(s) should be mounted as close to the Zone Mixer as practical, and housed in a screened enclosure if they are not individually screened. The preferred connection method is shown below.

Balanced outputs (XLRs):

pin 1 ground
pin 2 hot
pin 3 cold

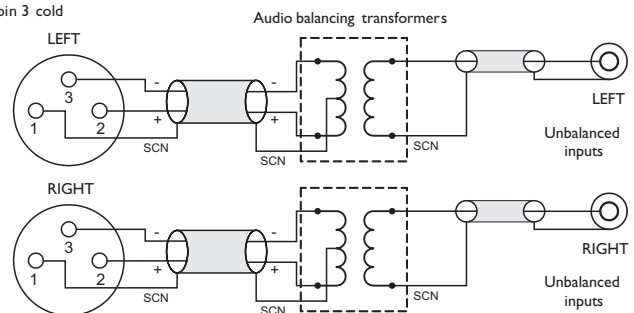

If transformers are not available, a balanced source may feed an unbalanced input directly as long as care is taken over how the connections are made. A variety of design techniques are in use to implement balanced outputs in audio equipment, and some designs require different wiring protocols to others. Installers are advised to check the manuals with each item for guidance on how the outputs should be connected to an unbalanced input.

However, the wiring method shown below will work in a large number of cases:

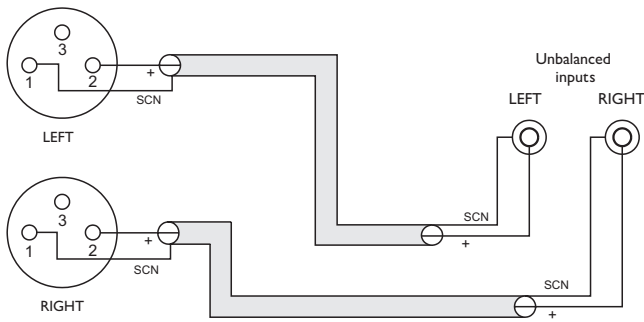

Balanced outputs (XLRs):

- pin 1 ground
- pin 2 hot
- pin 3 cold

Balanced sources:

Source equipment with balanced outputs may be connected directly to Line Inputs 3, 4 5 or 6. Use good quality twin-and-screen cable and connect to the mating screw-terminal connectors provided as shown below:

PIN	CONNECTION
1	Screen
2	Signal '-' (cold)
3	Signal '+' (hot)

If it is necessary to connect an item of source equipment with an unbalanced output to Line Inputs 3 to 6, connect the signal to Pin 3 ("hot") and Pin 1 (screen), as shown below:

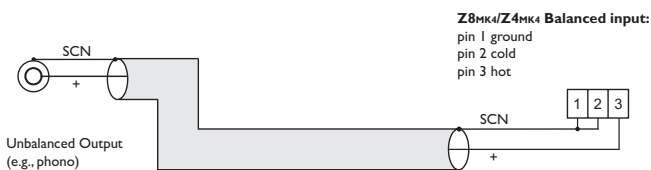

Mono and stereo sources:

The Z8MK4 and Z4MK4 are mono mixers; the stereo line inputs are summed internally to mono. Stereo sources should be connected in a normal stereo configuration, using both L and R inputs. If connecting a mono source with only a single output, it may be connected to either the left or the right input.

Zone outputs

Connect the inputs of the power amplifiers feeding the loudspeakers for each zone to the **OUTPUT** connectors for Zones 1 to 8*. Note that the zone outputs are all mono. The outputs are balanced and will drive input impedances down to 600 ohms. Nominal output level is 0 dBu (775 mV). The output is designed to drive professional/industrial power amplifiers with balanced inputs (typically on XLRs). In this case, wire as the diagram below. Note that the screen can be left unconnected at the source end if earth loops are a problem.

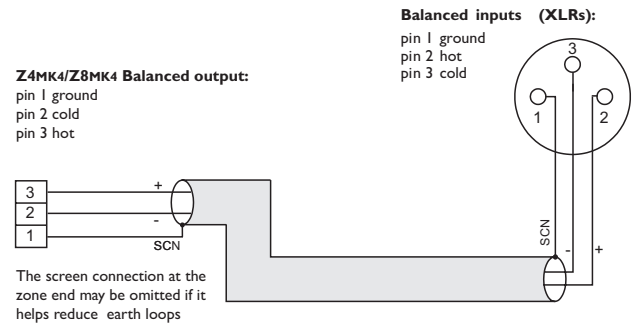

*ZONE 1 to 4 only on Z4MK4.

Amplifiers with unbalanced inputs:

If audio amplifiers with only unbalanced inputs are being used (e.g., hi-fi amplifiers), the following wiring should be adopted:

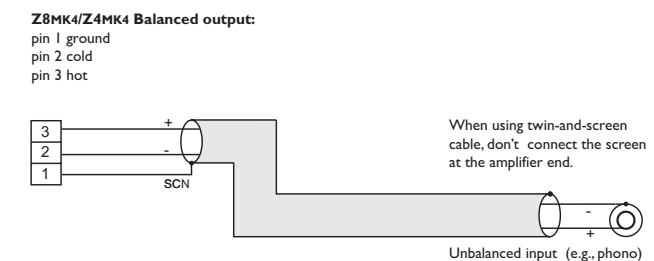
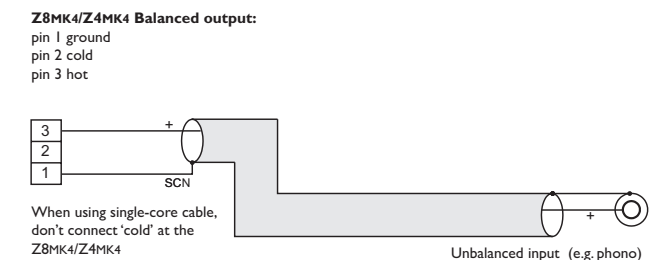

Microphone inputs

MICROPHONE 1 and **MICROPHONE 2** inputs are intended for the direct connection of microphones. They are electronically balanced and transformerless with an input impedance of greater than 2 kohms and optimised for use with microphones of 200 to 600 ohms impedance. The screw terminal input connectors should be wired thus:

PIN	CONNECTION
1	Screen
2	Signal '-' (cold)
3	Signal '+' (hot)

Unbalanced microphones may be used by connecting pin 2 to pin 1 (cable screen) in the mating (male) screw-terminal connector.

12 V phantom power is available, see “Phantom Power” on page 17.

Each mic input may be routed to any of the zones in use, at any level in each zone. Each zone may be configured so that any microphone announcements automatically reduce the music level in that zone while the announcement is in progress (see “Mic 1/Mic 2 priority” on page 19 for more details.)

The **PAGING MIC** input has the same electrical characteristics as **MICROPHONE 1** and **MICROPHONE 2**, but is intended for the connection of a dedicated paging microphone. Mic signals at this input will route to all zones at a level determined by the front panel preset **Paging Level** controls, ducking the music while an announcement is in progress. VOX or contact-closure triggering of the paging priority circuit may be selected; see “Paging mic priority” on page 19 for more details.

Facility Ports

Each zone of the mixer is provided with a Facility Port in the form of a rear panel 8-way RJ45 connector. The primary use of the Facility Port is for the connection of LM-2 remote active input modules, but it may also be used as a general-purpose, per-zone auxiliary balanced input (see “Using the Facility Ports as auxiliary zone inputs” on page 21 for more information on this application). Note that audio connected via a Facility Port will only appear at the same-numbered Zone Output, and no other.

The active modules operate on DC power supplied by the mixer. The current consumed by each module is minimal and in the vast majority of installations there will be no power supply issues. Nevertheless, installers are urged to check the data in the Appendix regarding PSU capacity (see “PSU capability and optional device current consumption” on page 28).

The pinout of the Facility Port connector is given in the table below:

PIN	USE	Cat 5 CORE*
1	Audio ‘cold’ phase (-)	White + Orange
2	Audio ‘hot’ phase (+)	Orange
3	Priority VCA control	White + Green
4	+ 12V	Blue
5	0V	White + Blue
6	-12V	Green
7	Music level control (0 to 10V)	White + Brown
8	Music source select control (0 to 10V)	Brown
SCN	Screen for system music controls	Connector shell

* Standard wiring for pre-made cables

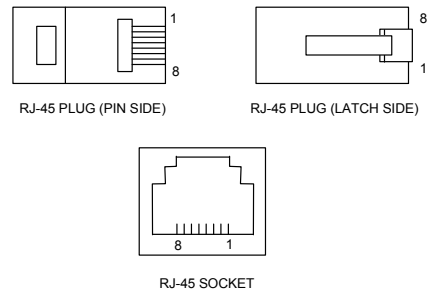

Please also refer to “LM-2 active input modules – general considerations” on page 21 for further information regarding installation of remote active input modules.

Connecting an LM-2 remote input module

The LM-2 should be connected to a Facility Port using screened Cat 5 cable. (Note that as the cable carries analogue audio, *only* screened Cat 5 should be used.) All 8 cores are used. The LM-2 includes controls for local music level and source selection, the wiring for these functions being catered for on the Facility Port. Thus it is not necessary to make any connections to the Zone’s **REMOTE SOURCE+LEVEL** Port.

The LM-2’s upper PCB is fitted with an RJ45 connector labelled **OUTPUT**. Connect this to the **FACILITY PORT** of the relevant Zone using screened Cat 5 cable with screened RJ45s at each end. Follow the colour coding shown in the previous table. The metal screening of the connectors should be bonded to the screen of the cable. Full details can be found in the LM-2 Installation Guide.

The second RJ45 connector on the LM-2, **LINK**, may be used to “daisy-chain” additional LM-2s, thus allowing multiple input modules to be installed at different locations in the zone. See the LM-2 Installation Guide for more details.

Before the LM-2's music source and level controls will operate, set the **MUSIC CONTROL** push-button switch ([17] on page 9) for the Zone where the LM-2 is installed to **REMOTE** (i.e., pressing it in). In this setting, the Zone's front panel **Music Source** and **Music Level** controls become inoperative.

Sometimes it is desirable to permit remote control of music level but keep music source selectable only on the mixer. In this case, internal jumper J1 on the sub-board for the Zone in use should be moved from 'SW' to 'FR'. This will render the LM-2's music source switch inoperative, and return source selection to the front panel. See page 26 for full details and jumper locations.

Paging System connections

Cloud PM Series paging microphones may be connected directly to the Z8MK4 and Z4MK4. All models except the PMI can use either the Cloud Digital Paging Interface or an industry-standard analogue interface; Model PMI uses the analogue interface.

PM microphones are available in 4, 8, 12 or 16-zone versions; the installer should be sure he/she understands how paging zones correspond to mixer zones before commencing wiring.

Connecting a PM4/4SA/8/8SA/12/16 paging mic via the Cloud Digital Paging Interface

The Z8MK4 and Z4MK4 are fitted with a Cloud Digital Paging Interface; this uses two RJ45 sockets: **IN** and **THRU**. Cloud PM Series Paging microphones may be connected directly to the **IN** socket with Cat 5 cable; the single connection provides all audio, control and power required by the microphone.

The **IN** port is able to supply 350 mA to power paging microphones. This is adequate to power one or two microphones of models PM-4, PM-8, PM-12 or PM-16. Cloud recommend that all '-SA' models (with spot announcement sound stores) are powered by a separate, external PSU, as described in the PM Series Installation Guide. (A suitable PSU is supplied as standard with all '-SA' models.) Note that the **THRU** port is not able to supply DC power, and is not intended for the connection of additional PM Series microphones (see below).

Connect the **OUT** socket of the PM Series microphone to the **IN** socket on the Zone Mixer with Cat 5 cable. The standard Cat 5/RJ45 wiring convention is shown opposite.

RJ45 PIN	CAT5
1	White + Orange
2	Orange
3	White + Green
4	Blue
5	White + Blue
6	Green
7	White + Brown
8	Brown

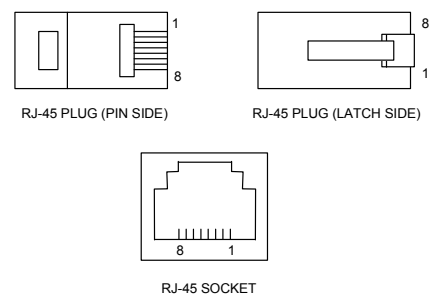

The Cloud Digital Paging Interface allows multiple PM Series microphones to be "daisy-chained". If more than one paging microphone is being installed – typically at different locations in the building, connect the **OUT** socket of one to the **IN** socket of the next.

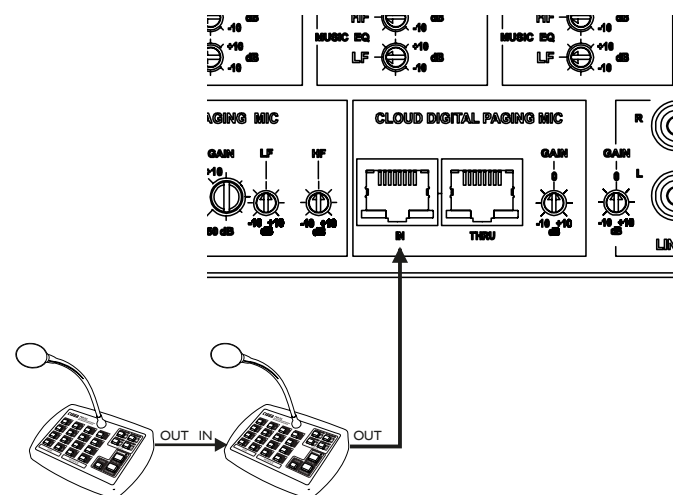

The **THRU** connector allows two or more Z8MK4/Z4MK4 mixers to be interconnected: for example, a PM16 paging microphone can address all sixteen zones it can support through the use of two Z8MK4 mixers. If the **THRU** socket is in use, the Interface termination will need to be disabled; this is done by moving an internal DIP switch; see "PCB jumper location and settings" on page 26 for details.

In systems using multiple mixers in conjunction with PM Series microphones, it is possible to redefine how the mixer interprets the zones being selected on the microphone by applying “zone offset”; this allows the microphone to address a higher-numbered set of zones. This topic is covered in full detail under “Zone Offset” in the Setting Up & Operation section of the manual; see page 19.

IMPORTANT - Please refer to the PM Series Installation Guide for full information regarding maximum cable length, buss terminations and current requirements.

The earlier Cloud CDPM Series of paging microphones is also compatible with the Digital Paging Interface.

Connecting a PM4/4SA/8/8SA/12/16 paging mic via the analogue interface

Two connections are required: the paging mic audio signal should be connected to the **PAGING MIC** Input ([7] on “Description of rear panel” on page 9) and the control cable to the 10-pin **ZONE ACCESS SWITCHING** port ([12] on “Description of rear panel” on page 9). The pinout of the **ZONE ACCESS SWITCHING** port is given below:

FUNCTION	Z8MK4 PIN NO.	Z4MK4 PIN NO.
0V	1	1
Zone 1	2	2
Zone 2	3	3
Zone 3	4	4
Zone 4	5	5
Zone 5	6	
Zone 6	7	
Zone 7	8	
Zone 8	9	
+12V	10	6

Standard two-core screened audio cable may be used for the audio signal, and stranded multicore cable with an overall screen for the control cable. The number of cores required in the latter will be determined by the model of PM microphone being used and whether the mixer is a Z8MK4 or Z4MK4; however, note that one additional core will be required if the PM Series microphone is to be powered from the Zone Mixer. (Note that ‘-SA’ versions of PM Series microphones cannot be powered by the Z8MK4 or Z4MK4, and require an external PSU).

Connections on the PM microphone are made via the rear cable access glands and screw terminal blocks on the internal PCB (**TERMI**, **TERM2** and **TERM8** in the example shown below). Full connection details and notes on power supply considerations can be found in the PM Series Installation and User Guide.

The following diagram shows both the cable connections between a PM8 and a Z8MK4. Note that the DC power supply connection will not be required if the PM microphone is powered independently (either by a local PSU or via the network from another PM unit).

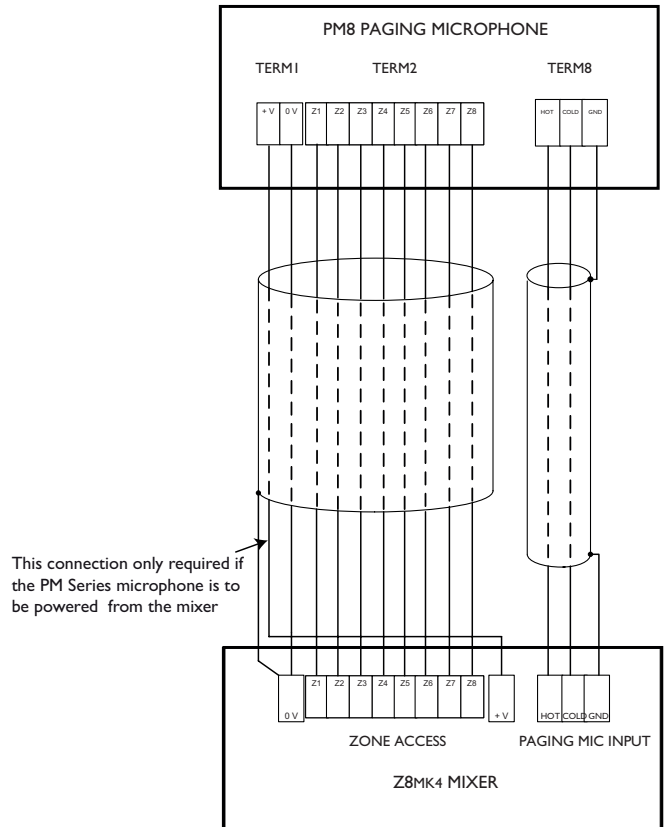

For individual zone paging as described above, the paging mic priority trigger should be selected to ‘SW’ by moving J5 on each zone sub-board in the Zone Mixer. See “Paging mic priority” on page 19 for further information.

Connecting a PMI paging mic

The PMI is a simple, passive paging microphone suitable for situations where announcements are always made to the same zone(s). It can be connected directly to Z8MK4/Z4MK4 zone mixers’ analogue paging interface, the control cable being wired to the pin(s) of the **PAGING ACCESS SWITCHING** port corresponding to the zone(s) in which announcements are required. Any or all of the zones may be paralleled if multiple zones need to operate from the PMI.

An alternative method for achieving paging to all zones is to ignore the control cable altogether and set the paging priority trigger for all zones to VOX. By doing so, it is the presence of an audio signal from the mic itself that triggers the priority circuitry. However, if this method is to be employed, the mating multipin connector must be left plugged into the **PAGING ACCESS SWITCHING** port, with the pins corresponding to all the zones that the PMI is to address connected to 0 V. See page 19 for further information.

Either a single 2-pair individually-screened cable may be used (this gives the neatest finish), or two separate standard microphone cables. Note that the PMI does not require DC power. Connections on the PMI are made via the rear cable gland in the base and the screw terminal blocks on the internal PCB (U2 and U3). Full connection details can be found in the PMI Installation and User Guide.

The diagram below shows the connections between a PMI and a Z8MK4. Use of 2-pair cable is assumed; the same wiring principle is adopted if separate cables are being used for audio and control.

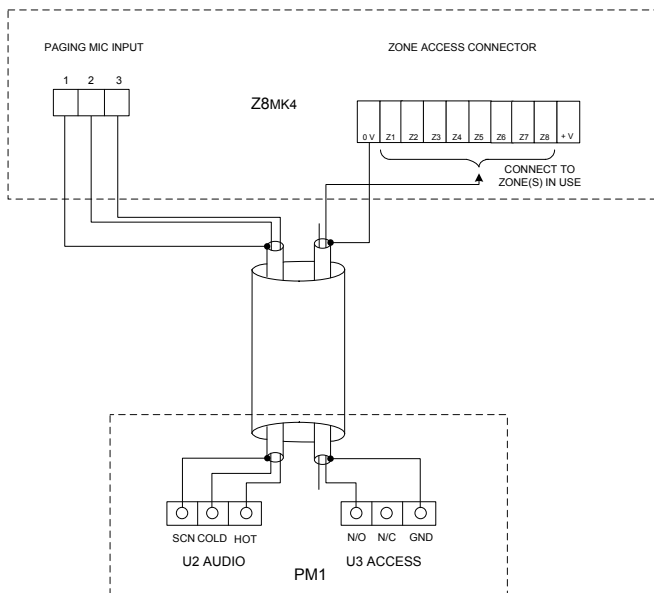

Music Control

Like many other Cloud products, the Z8MK4 and Z4MK4 allow remote control of music level and source selection in each zone. Cloud remote control plates from the RL-1 Series (music level only) and RSL-6 Series (music level and source selection) provide an elegant solution, though control via a DC voltage from third-party systems is also possible (see page 22).

Both types of plate connect via the **REMOTE SOURCE + LEVEL** port for the relevant zone (see [16] on page 9). This connector is a 3-pin 5 mm-pitch screw terminal type.

Connecting an RL-1 Series remote control plate

Wire the remote control plate as shown below. Either single-core screened or twin-and-screen cable may be used; in the case of the latter, ignore one of the cores. Maximum reliable cable run is 100 m.

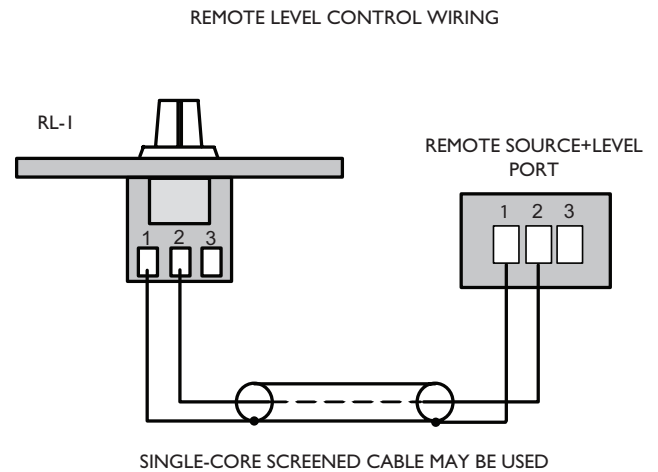

Before the RL-1 will operate, the zone's **REMOTE SOURCE+LEVEL** port must be enabled by setting the adjacent push-button switch ([18] on page 9) to REMOTE (i.e., pressing it in). In this setting, the zone's front panel **Music Level** and **Music Source** controls become inoperative. As music source selection will still be required from the mixer's front panel when an RL-1 is in use, the REMOTE setting may be overridden *for the source selection control only* by moving internal jumper J1 on the sub-board for the zone in question. See page 26 for location of internal jumpers.

Connecting an RSL-6 Series remote control plate

Wire the remote control plate as shown below. Twin-and-screen cable should be used. Maximum reliable cable run is 100 m.

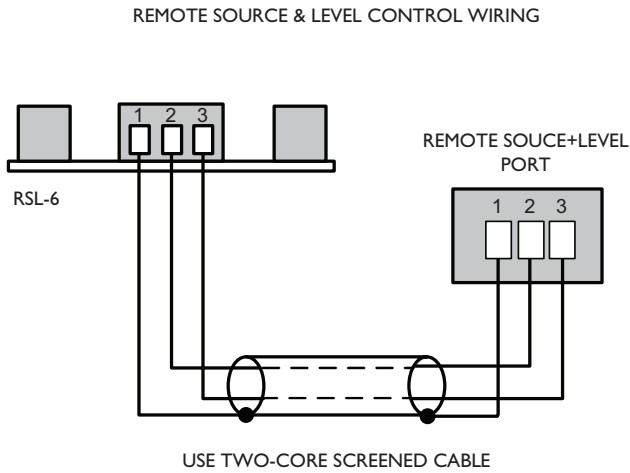

Before the RSL-6 will operate, the zone's **REMOTE SOURCE+LEVEL** port must be enabled by setting the adjacent push-button switch ([18] on page 9) to **REMOTE** (i.e., pressing it in). In this setting, the zone's front panel **Music Level** and **Music Source** controls become inoperative.

Music Mute

External muting of music is available at the **MUSIC MUTE** connector. National or Local Authority regulations governing such systems may require that normal programme material (i.e., music) should be muted in an emergency, to ensure that any emergency messages are clearly audible.

The **Music Mute** input is a 2-pin 5 mm-pitch screw-terminal connector. It should be connected to the appropriate alarm output on whichever building management system registers the alarm (typically the Fire System). The alarm output must be volt-free; if no such output is available, an intermediate relay or other isolation device must be installed between the alarm output and the **Music Mute** input.

The Mute input can be set to operate on either normally open (N/O) or normally closed (N/C) contacts via an internal DIP switch (see "PCB jumper location and settings" on page 26). The factory default setting is N/O, thus requiring a short-circuit to be applied across the two pins of the connector for muting to occur.

Visual indication of muting being activated is given by the **Mute LED** on the front panel.

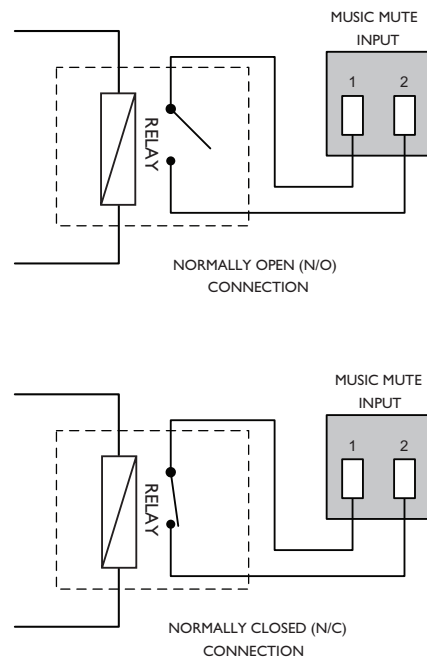

SETTING UP & OPERATION

Music Inputs

Gain & level

To avoid dramatic changes in volume when switching between sources, the Z8MK4/Z4MK4's music inputs are provided with preset gain trim controls ([3] on page 9). These vary the input sensitivity from -11 dBu to +12.5 dBu (approx. 218 mV to 3.2 V). When setting the system up, play audio from all the sources in use and listen to them one at a time in a convenient zone (preferably that in which the mixer is located) at a reasonable volume. Taking a source of "average" volume as the reference, the gain controls of the others should be adjusted so that there is no appreciable difference in volume between any of the sources. (With a typical music source, setting the gain on its channel to mid-way is a good starting point.) Note that consideration may need to be given to the type of programme in use, particularly if one or more sources are TV sound.

In normal operation, the music level in each zone is set with the **Music Level** control on the front panel ([2] on page 8). This control will not be operative if the corresponding rear panel **MUSIC CONTROL** push-button is set to REMOTE. When setting the audio system up, set the gain controls (if any) on the power amplifiers for each zone to minimum, then turn the **Music Level** control on the mixer to maximum. Then increase the zone volume by turning up the power amplifier gain until it is as loud as will be required in normal use. This method ensures that excessive volumes will not be possible with the mixer's operational controls.

Note that the setting of the music level has no effect on microphone or paging volume.

Local/remote control

If a zone has an RL-1 or RSL-6 Series remote control plate or an LM-2 mic/line input module connected, the rear panel **MUSIC CONTROL** push-button must be set to REMOTE (button in) for the remote controls to be operative and for the corresponding front panel controls to be disabled. Zones without such plates should be set to LOCAL (button out).

The setting of the internal PCB jumper J1 on each zone sub-board is also relevant. The default setting is SW. This means that zone music source selection will be determined by the rear panel switch setting; the front panel control in LOCAL and via a remote plate or other external control in REMOTE. If the jumper is set to FR, the source selection will always be made with the front panel control whatever is connected at the rear panel or the setting of the **MUSIC CONTROL** switch. If external control of music level only (i.e., not source selection) is required, J1 should be set to FR and the **MUSIC CONTROL** switch to REMOTE.

Microphone Inputs

Phantom Power

Each primary microphone input (**MICROPHONE 1** & **MICROPHONE 2**) has 12 V phantom power available. This will be adequate to power a wide range of condenser microphones. (Some "studio quality" mics may require a higher phantom voltage and thus necessitate an external PSU.) To enable phantom power at the mic inputs, the relevant section(s) of the internal motherboard DIP switch SW3 should be moved to their ON positions. See page 26 for switch locations.

Phantom power should NOT be enabled if dynamic microphones are to be used.

Gain & level

Each primary microphone input (**MICROPHONE 1** & **MICROPHONE 2**) is provided with a rear panel preset gain control ([5] on page 9). A wide range of gain is available and there should be no problem in obtaining a satisfactory level from any normal microphone.

The mic **GAIN** control should be adjusted by speaking normally into a microphone of the correct type. Turn the front panel **Mic Level** control up to maximum and listen in a convenient zone; the rear panel **GAIN** control should be carefully advanced until the mic volume is as loud as it is ever likely to be needed, and then reduced slightly. There should be no audible distortion. The use to which the microphone is to be put should be borne in mind – karaoke is more likely to overload the mic preamplifier than spoken announcements, if the gain is not set correctly.

In normal operation, the mic level in each zone is set with the **Microphone 1** and **2** level controls on the front panel ([3] & [4] on page 8).

EQ

Each mic input has associated HF and LF EQ controls ([6] on page 9) These provide 10 dB of cut or boost at 5 kHz and 100 Hz respectively and should be adjusted by listening to achieve a clear mic sound. Again, the application should be borne in mind when making adjustments.

High-pass filter

Each mic input has a fixed 100 Hz high-pass filter to remove the lowest frequencies. This helps to reduce the effects of breath blasts and microphone handling noise. The filter is always in circuit.

Paging mic input

Phantom Power

The **PAGING MIC** input also has 12 V phantom power available. This will NOT be required if a Cloud paging microphone is being used with the mixer, but may be necessary with other manufacturers' equipment. It is enabled by moving its section of the internal motherboard DIP switch SW3 to its ON position. See page 26.

Gain & level

The **PAGING MIC** input has a rear panel preset gain control ([8] on page 9). A wide range of gain is available and there should be no problem in obtaining a satisfactory level from most paging microphones.

The mic **GAIN** control should be adjusted by making an announcement. Set the front panel Paging Mic Level preset control at about halfway and listen in a convenient zone; the rear panel gain control should be carefully advanced until the announcement is heard clearly and without distortion. If possible, the person who will normally make paging announcements should speak when making this adjustment.

Following the setting of the paging mic gain, the paging level in all the other zones should be set, by listening in each zone, with the **Paging Mic Level** controls on the front panel ([5] on page 8).

EQ & high-pass filter

The **PAGING MIC** input has associated HF and LF EQ controls ([9] on page 9). These are identical to the MIC 1 & MIC 2 EQ controls (see previous page) and should be adjusted similarly. A 100 Hz fixed filter is also included in the circuitry, as with the other mic inputs.

Cloud Digital Paging Mics

Cloud PM Series Digital Paging Microphones can be connected directly to the **IN** connector of the **CLOUD DIGITAL PAGING MIC** interface (see [10] at page 9), using a single Cat 5 cable. For many situations, this will be all that is required at installation, but there are two factors which may need to be taken in consideration: network termination and zone offset.

Network termination

Network termination rules apply to the Cloud Digital Paging Interface. The Z8MK4/Z4MK4 and one or more PM Series microphones constitute a network, and buss terminations should be set ON in the two devices at the "ends" of the chain, and OFF in all others.

The buss termination in the Zone Mixer is set ON at the factory, but may be set OFF by moving one section of internal motherboard DIP switch SW2. Refer to page 26 for location of motherboard components.

The diagrams below indicate how these rules are applied in some common wiring schemes.

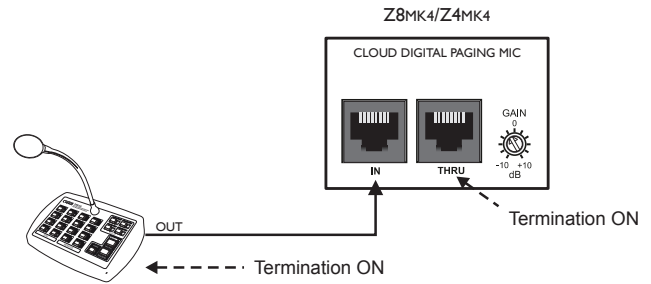

Example 1

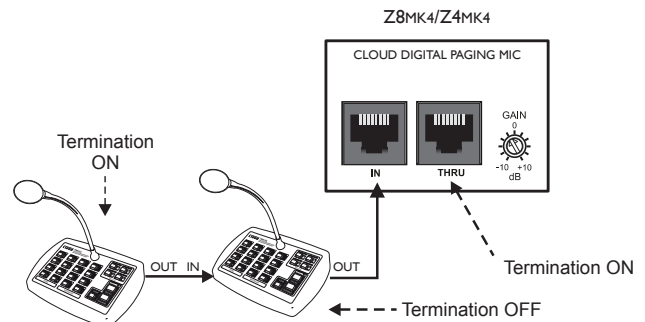

Example 2

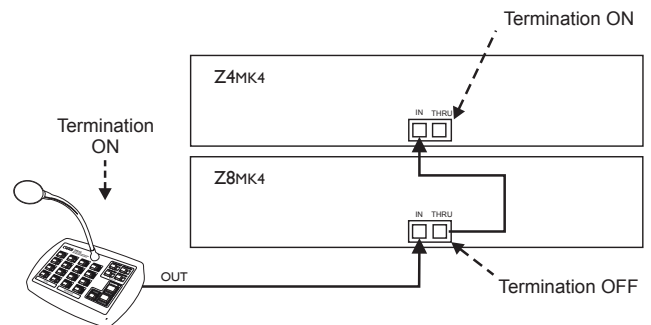

Example 3

- In the simplest implementation of just one paging microphone, the terminations should be set ON at both the Zone Mixer and the microphone.
- If two or more microphones are daisy-chained to the Zone Mixer's **IN** socket, terminations must be ON at the Mixer and the "end" microphone only.
- If two Zone Mixers are daisy-chained using the **IN** and **THRU** connectors, the terminations at the "ends" of the chain should be ON. In Example 3 above, this will be at the paging microphone and Mixer #2. The termination in Mixer #1 should be set to OFF (as it is in the "middle" of the chain).

Refer to the PM Setup and Installation Guide (supplied with each PM paging mic) for information on setting the buss termination in the microphones.

Zone Offset

The purpose of the Zone Offset is to permit Cloud PM paging microphones to address a differently-numbered set of zones from their normal assignment. Zone Offset is generally used in systems employing more than one Zone Mixer, interconnected using the **THRU** port of the Digital Paging Interface of one Mixer.

PM Series microphones support up to 16 zones, whereas the Z8MK4 and Z4MK4 only support eight and four zones respectively. For example, to permit a PM16 to page Zones 9 and higher in a system utilising two Z8MK4s, a fixed numeric offset of 8 should be set in the “second” Z8MK4 (and left at the default value of 0 in the “first”). With the first Z8MK4 feeding audio to Paging Zones 1 to 8 and the second to Paging Zones 9 to 16, correct paging of the higher-numbered Zones will result.

Please see the Application Examples section in the Appendix of this Guide (page 24) for an example of such a system.

Zone Offset is set by two sections of internal motherboard DIP switch SW2. Zone Offsets of 0 (the factory default), 4, 8 or 12 may be selected by the two binary-weighted switches, as summarised in the table below:

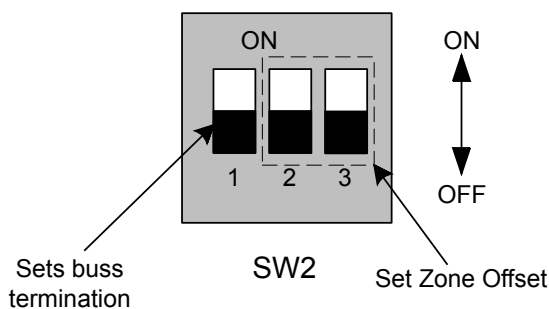

ZONE OFFSET	SW2/2	SW2/3
0	OFF	OFF
4	OFF	ON
8	ON	OFF
12	ON	ON

Refer to “PCB jumper location and settings” on page 26 for details of SW2’s location.

Zone Outputs

In normal operation, the music level in each zone will be set by the front panel **Music Level** control, or by a corresponding control on a remote plate. Follow the procedure described previously (page 17) to adjust the music level in each zone.

EQ

The various zones in a building often have different acoustic properties, and may also have different models of loudspeaker installed. The Z4MK4 and Z8MK4 are fitted with HF and LF EQ adjustments ([14] on page 9) for the music signal at each zone output to enable the audio frequency response to be best matched to each zone. The controls should be adjusted

by listening; up to 10 dB of cut or boost at 10 kHz (**HF**) and 50 Hz (**LF**) is available. Note that these EQ adjustments do not affect the frequency response of microphones or paging.

Priorities

The Z4MK4 and Z8MK4 offer several options for determining what happens to music signals when announcements are made. The options are selected via internal jumpers, and should be set to suit the requirements of the installation when the system is installed. See page 26 for location of the internal jumpers.

Mic 1/Mic 2 priority

By default, fully automatic, voice operated priority is provided for the microphone inputs. When either microphone is used, all music signals will attenuate by approximately 30 dB; after the announcement, the music signals will restore smoothly to their former level, over a period of approximately two seconds.

The Mic 1/Mic 2 priority over music can be disabled on a per-zone basis by setting J6 on the relevant zone sub-board to the ‘OFF’ position.

Paging mic priority

When an announcement is made via either the paging mic input or the Digital Paging Mic Interface, it has full priority over both the music signals and any microphones in use via **MICROPHONE 1** and **MICROPHONE 2** inputs. For most installations this will be a required priority for safety reasons, but may be overridden (see following page).

Paging priority can be triggered either by voice detection or by the grounding of the access contact; the sub-board jumper J5 should be set to ‘VOX’ for voice triggering (the default) or set to ‘SW’ for access contact triggering. If PM Series multi-zone paging microphones form part of the system, J5 will usually be set to ‘SW’; they will operate satisfactorily in VOX mode, but this leaves the possibility that the priority may be released (which will cause the music to resume) if the announcement has prolonged gaps for any reason.

When multiple PM Series paging microphones are in use, it is possible for one to have a priority over the others. This is a function of the microphones, not of the mixer; please consult the PM Series User and Guide for more information.

Note that if *both* the Digital Paging Mic Interface and the Paging Mic Input are in use – e.g., with a Cloud PM Series mic and a third-party microphone using the analogue interface – the Digital Interface always has priority. If announcements are made from both microphones simultaneously, the mic connected to the analogue interface will not be heard.

Override of Paging mic priority during Music Mute

In some installations, it may be more appropriate for a microphone connected to the 'non-paging' mic inputs (**MICROPHONE 1** and **MICROPHONE 2**) to take priority in an emergency situation. This can be achieved by moving J8 on the zone sub-boards from 'EN' to 'DIS'.

With this jumper setting, the normal priority which the Paging Mic has over Mics 1 and 2 will be disabled when the **MUSIC MUTE** input (see page 16) is active, as it will be in an emergency situation. All microphone inputs remain active, so that any may be used for emergency announcements.

Note that this priority setting only applies when Music Mute is active; during normal operation, the Paging Mic will always take priority over MIC 1 or MIC 2 whatever the setting of J8.

Note also that because this facility is set on a per-zone basis (by moving J8 on each zone sub-board), it would normally be desirable to move J8 to the same setting on every sub-board.

Line 6 priority

It may sometimes be necessary for one music input to have priority over all the others; for example, a jukebox in a bar, or a digital sound store programmed to make automatic announcements in a public space. Line input 6 may be set to have priority in any or all zones over whichever source is selected for the zone by its **Music Source** control. This priority is set by moving jumper J2 to the 'ON' position on as many zone sub-boards as required. (The default setting is 'OFF'.)

When the priority is selected, a signal present at Line 6 will force the zone's source selection to that input; when the signal disappears, the previously-selected source will be restored over a time constant which is determined by the setting of J3 on each zone sub-board.

The default release time is 3 s, but may be set on a per-zone basis to 6 s by moving J3, or to 12 s by removing J3 altogether.

Microphone priority over input at Facility Port

If an LM-2 remote input module is in use in a zone, it is possible to give any microphone connected at the mixer itself (at **MICROPHONE 1**, **MICROPHONE 2** or **PAGING MIC**) priority over input sources connected at the plate. This might be desirable in function rooms, for example, where building-wide announcements may need to interrupt any local use.

This priority is set by J4 on the zone sub-board. The default setting is 'OFF'; in this position microphones or other sources connected at remote input modules will be autonomous and will not be overridden by announcements made via the mixer's mic inputs. Setting J4 to 'ON' will give Mic 1, Mic 2 and the paging mic inputs priority.

Note that this priority is independent of the LM-2's local **MIC PRIORITY** function which is selected on the remote module itself.

OPTIONS AND ADDITIONAL INFORMATION

LM-2 active input modules – general considerations

Cloud LM-2 remote input modules are available in various form factors, to fit double-gang UK or other back boxes styles. Please refer to www.cloud.co.uk/accessories for details of the full range. Back boxes of either the recessed type or surface-mounting type may be used, providing they are at least 35 mm deep.

The modules should be connected to the **FACILITY PORT** of the relevant zone using screened Cat 5 cable as described at page 12. The **OUTPUT** connector on the module and the **FACILITY PORT** on the mixer are both screened RJ45 connectors.

Great care must be taken when connecting active input modules; power is derived from the mixer and some wiring errors may cause failure of the mixer. Please check all wiring before testing the system.

IMPORTANT: Please refer to page 28 for information regarding current draw and power supply capability.

Connecting multiple LM-2s

It may be desirable to connect local microphones or music sources at more than one location in a zone (in a large function room, for example). LM-2 input modules may be “daisy-chained” using their second **LINK** RJ45 connectors to achieve this. All LM-2s thus wired will, of course, only be available to the zone to whose Facility Port the chain is connected.

Remember to consider the current drawn by any additional input plates – see page 26 for details of current consumption and PSU capability.

See also the section below: “Disabling the Facility Input Noise Gate”.

Using the Facility Ports as auxiliary zone inputs

The Facility Port provides a balanced audio input. If a Facility Port is not connected to an LM-2 remote input module, it may be used as a direct input to the zone from other equipment forming part of the system (for example, a permanently installed DJ mixer which only ever needs to feed its output to that particular zone).

Wire an external balanced source to the facility port as shown below:

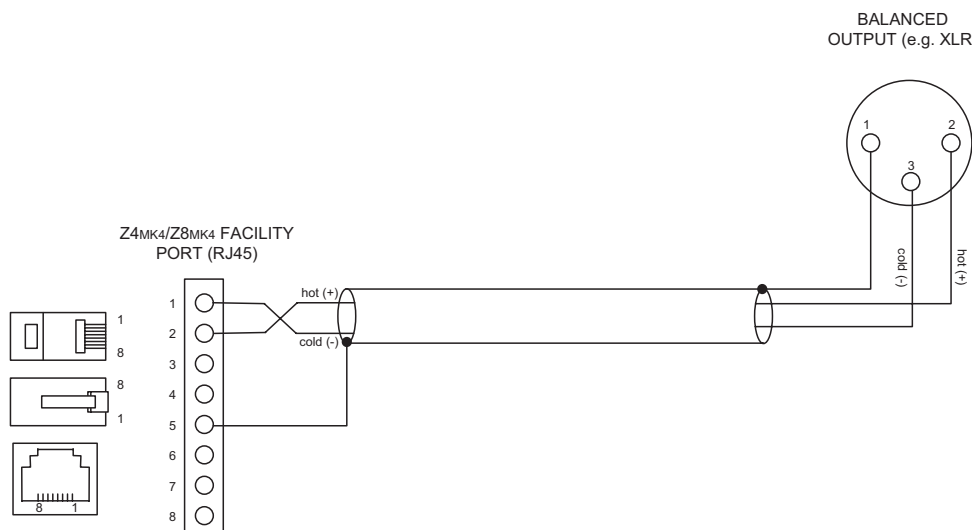

An unbalanced source may also be connected; the use of balancing transformers is recommended.

Disabling the Facility Port Noise Gate

The balanced audio input at the Facility Port is fed through an internal noise gate, to minimise any background noise from an LM-2 or other source connected to the port. The threshold of the noise gate is fixed at a fairly low level, so that use of a microphone connected to an LM-2 will normally open the gate immediately.

If any problems are experienced with the gate’s operation, it may be disabled by moving jumper J7 on the zone sub-board. When disabled, even very low-level audio signals from the LM-2 or other external source will be audible.

RL-1 Series and RSL-6 Series remote control plates – general considerations

Cloud RL-1 Series and RSL-6 Series remote control plates are available in three form factors: two fit single-gang UK or American electrical back boxes respectively, while the third is a 50 x 50 mm “Media” module, suitable for “Euro-module” mounting frames available in most European countries. Back boxes of either the recessed type or surface-mounting type may be used, providing they are at least 25 mm deep.

The plates should be connected to the **REMOTE SOURCE+LEVEL** port of the relevant zone using single- or twin-core screened cable as described at page 15 and page 16. The plate terminations are conventional screw terminals and the **REMOTE SOURCE+LEVEL** port on the mixer is a 3-pin 5 mm-pitch screw terminal connector.

The remote control plates are passive and thus do not draw any current from the mixer.

Control of music source and level via external DC

It may be necessary in some installations to adjust the music level and select music source in one or more zones from an external control system (e.g., Crestron, AMX, etc.). If the **REMOTE SOURCE+LEVEL** ports are not required for RL-1/RSL-6 Series remote control plates, they may be used to receive DC voltages from the external system to effect these adjustments.

Both music source selection and level can be controlled over their full ranges with a DC voltage of 0 to +10V. The pinout of the **REMOTE SOURCE+LEVEL** port is as follows:

PIN	USE
1	0V ref.
2	Music level control (0 to +10V)
3	Music source selection (0 to +10V)

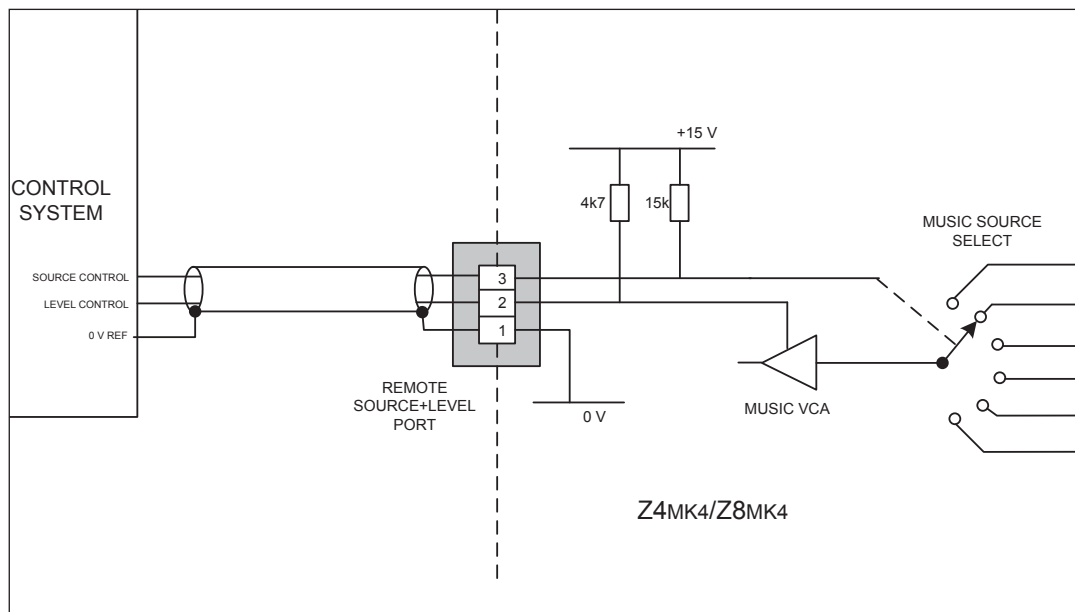

NOTE: If the control voltage source is not isolated from the power earth, there is a small risk of creating a ‘ground loop’ by linking the mixer technical ground (0V) to the ground (0V) of the equipment supplying the control voltages. To minimise this risk, we suggest that all pieces of equipment be in close proximity, and supplied from the same power outlet.

Music level

Music level in a zone may be varied over its full range by applying a DC voltage of between 0 and +10V to pin 2, the 0V reference being connected to Pin 1. 0V on pin 2 corresponds to maximum level and +10V will produce 60 dB of attenuation. The rate of attenuation is approximately 165 mV/dB.

Note that there is an internal 4k7 “pull-up” resistor between pin 2 and the internal +12V rail. If pin 2 is left “floating”, this pull-up will result in full attenuation. The output impedance of the control voltage source should be low enough to overcome the effect of this resistor.

Music source

Music source for a zone may be controlled by applying various DC voltages of between 0 and +10V to pin 3, the 0V reference being connected to pin 1. 0V at pin 3 will select Line input 6 and between +7.5 and +9V will select Line input 1. The other line inputs will be selected with intermediate voltages. Taking pin 3 above +9V will deselect all inputs, making the zone effectively 'off' for music.

The table below lists the DC voltages required at pin 3 to select each line input. The third column is the value of a resistor which should be connected between pins 1 and 3 to permanently 'force' a zone to a particular line input.

INPUT	DC VOLTAGE	RESISTOR VALUE
OFF	>+9.0V	
Line 1	+7.5V	16k
Line 2	+6.0V	11k
Line 3	+4.5V	6k8
Line 4	+3.0V	3k9
Line 5	+1.5V	1k8
Line 6	0V	short-circuit

Note that there is an internal 15k "pull-up" resistor between pin 3 and the internal +12V rail. If pin 3 is left "floating", this pull-up will cause 'OFF' to be selected. The output impedance of the control voltage source should be low enough to overcome the effect of this resistor.

Fitting loudspeaker EQ cards

The Z8MK4 and Z4MK4 are compatible with various popular installed-sound loudspeakers; a single-channel loudspeaker equalisation module may be fitted to as many zone outputs as necessary to optimise the frequency response of the channel to the loudspeaker type being used.

Please check the Cloud website (www.cloud.co.uk/accessories) for makes and models of loudspeakers for which EQ cards are available.

To install equalisation modules, first remove the top cover from the Z8MK4/Z4MK4 (6 screws). The modules plug into the white 12-pin connectors labelled CON2 on the vertically-mounted sub-boards; there is one sub-board for each zone output, and the modules can be plugged in without removing the sub-boards. Note the header connectors on the PCB have two notches on one side only; these engage with lugs on the equalisation module's mating connector to ensure correct orientation.

See the Appendix section "PCB jumper locations and settings" page 26 for further details. Replace the top cover with the original screws after fitting.

APPENDIX

The Z8MK4 and Z4MK4 will find application in many types of premises, including shops, bars, hotels, schools, conference centres, offices, etc.

Application example I

A typical example using most of the Zone Mixer's facilities is given below.

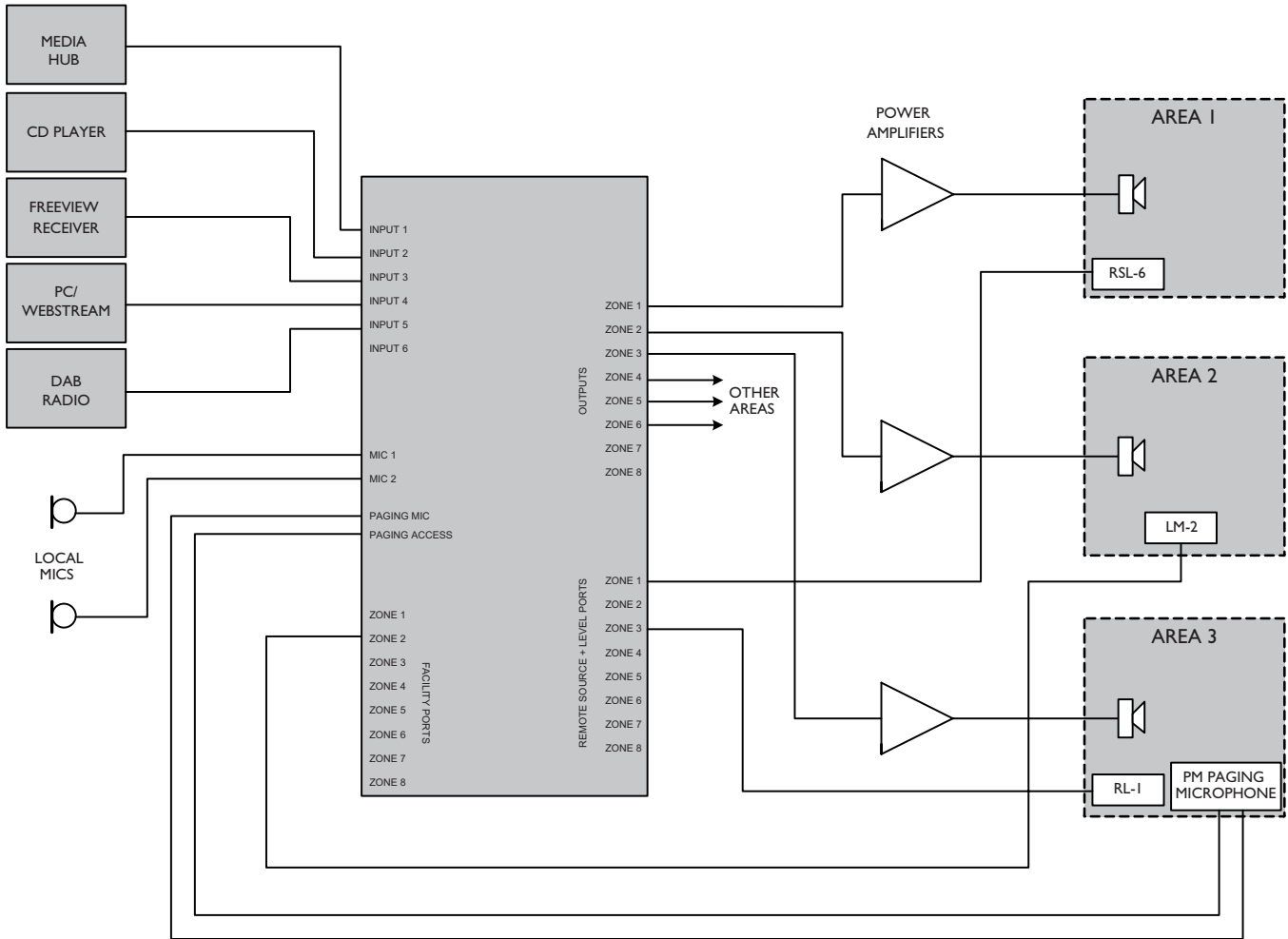

The diagram depicts a system where four possible music (or other audio) sources are made available to three or more zones (areas). Only three zones are shown for clarity. Points to note:

- Area 1 and Area 3 have remote control plates installed: an RSL-6 Series (music level and source) in Area 1 and an RL-1 Series (music level only) in Area 3. These are wired to the **REMOTE SOURCE+LEVEL** Ports for their respective zone outputs.
- Area 2 includes an LM-2 mic/line input module wired to Zone 2's **FACILITY PORT**. This would allow both a microphone and a portable stereo music source to be connected in that area. The LM-2 also provides music source and level control; note that the LM-2 does not require a second connection to the **REMOTE SOURCE+LEVEL** Port to enable this.
- Area 3 has a Cloud PM paging microphone, which would be used to originate voice messages to any of the areas. The paging level to Area 3 (if required) would be adjusted on installation to be at a level that does not cause feedback.

Application example 2

This example shows how two Zone Mixers – in this case one Z8MK4 and one Z4MK4 – can be used in conjunction with the Cloud Digital Paging Interface to allow a PM12 Paging Microphone to correctly address all 12 zones.

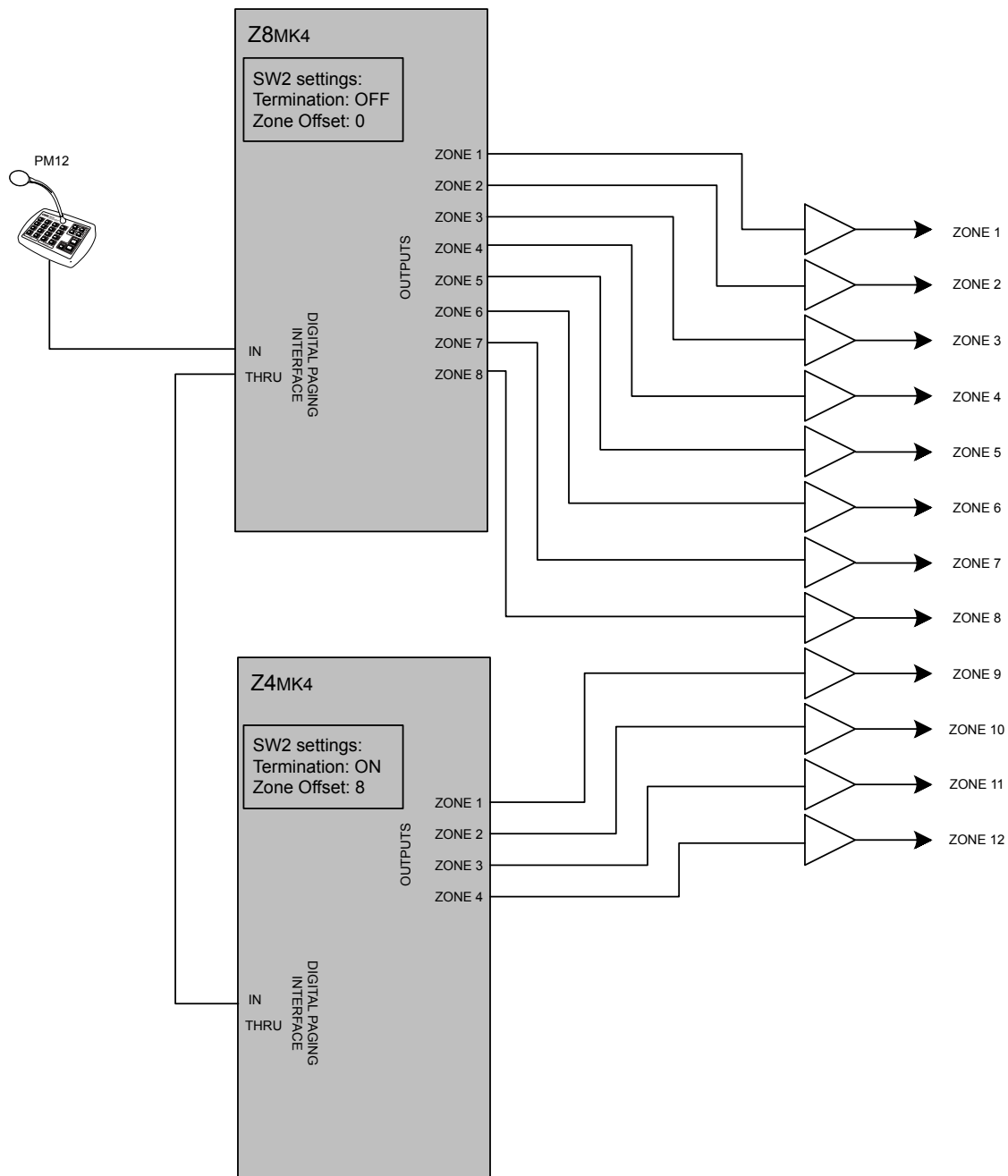

The Digital Paging Interface **THRU** port of the Z8MK4 is connected to the **IN** port of the Z4MK4 using Cat 5 cabling. The important points to note are:

- The buss termination should be set **OFF** in the Z8MK4, as it is not at the “end” of the network chain. However, the termination in the Z4MK4 should be set **ON**.
- Zone Offset should be set to 8 in the Z4MK4 (and left at zero in the Z8MK4). This will allow zone buttons 9 to 12 on the PM12 to correctly address the four zones driven by the four-channel Zone Mixer.
- The diagram only shows the Digital Paging Interface and output connections for simplicity. In practice, all music sources and microphone inputs would need to be paralleled to both Zone Mixers. Direct parallel connection will probably prove satisfactory for the line inputs, but the use of a two-way passive or active mic splitter is recommended for use with the microphone inputs.

PCB jumper location and settings

The Z8MK4 and Z4MK4 have various internal switches and jumpers, the setting of which may require alteration during installation. Note that there are switches on the motherboard and jumpers along the top edge of the individual zone sub-cards. The table below lists each switch and jumper and its purpose, together with the factory default setting. Note that options selectable by jumpers on the zone sub-board are per-zone, and will need to be set on as many zone sub-boards as necessary.

MOTHERBOARD SWITCHES				
SWITCH	NAME		EFFECT	DEFAULT
SW1	Music Mute N/O, N/C		N/O: contact closure required for muting N/C: contact opening required for muting	N/O
SW2	1	CDPM buss termination	OFF: no buss termination off (Mixer not at end of buss) ON: buss termination on (Mixer at end of buss)	ON
	2	CDPM Zone Offset	OFF: MSB = 0 ON: MSB = 1	OFF
	3		OFF: LSB = 0 ON: LSB = 1	OFF
SW3	1	MIC 1 phantom power	OFF: MIC 1 phantom power OFF ON: MIC 1 phantom power ON	OFF
	2	MIC 2 phantom power	OFF: MIC 2 phantom power OFF ON: MIC 2 phantom power ON	OFF
	3	Paging Mic phantom power	OFF: paging mic phantom power OFF ON: paging mic phantom power ON	OFF
ZONE SUB-BOARD JUMPERS				
JUMPER	NAME		EFFECT	DEFAULT
J1	Music source selection		SW: Follows rear panel switch FR: Always via front panel only	SW
J2	Line 6 priority		OFF: No priority ON: Line 6 has VOX-triggered priority over other sources	OFF
J3	Line 6 priority release time		3S: 3 seconds. release time 6S: 6 seconds release time ABSENT: 12 seconds release time	3S
J4	Mic priority over facility input		OFF: No priority ON: MIC 1, 2 & paging mic have VOX-triggered priority over signals at facility port	OFF
J5	Paging mic priority trigger		VOX: Paging mic signal triggers priority SW: Contact closure at Access Port enables paging mic priority	VOX
J6	MIC 1/MIC 2 priority		OFF: No priority – mics mix with music ON: Music ducks when mics in use	ON
J7	Facility Port input noise gate		EN: noise gate enabled DIS: noise gate inoperative	EN
J8	Emergency Paging mic priority override		EN: Paging Mic always has priority over other sources during Music Mute DIS: No priority - all mic inputs are active during Music Mute	EN

The diagrams below show the locations of the internal switches and jumpers (not to scale) on each of the two boards. The Z8MK4 is shown; only zone sub-boards 1 to 4 are fitted to the Z4MK4.

The jumpers have two possible positions; the black square in the symbol indicates the default setting. If any switches or jumpers need to be changed, turn the Zone Mixer off and disconnect it from the mains. Undo the 6 screws securing the top cover of the unit and remove it. The jumpers on the zone sub-boards are readily accessible from above; use a pair of small pliers to gently remove the jumpers from the PCB headers and reposition them. The switches on the motherboard can be moved with a long, fine screwdriver. Refix the top cover using the original screws.

The diagrams also show the locations of the socket for the optional loudspeaker EQ cards.

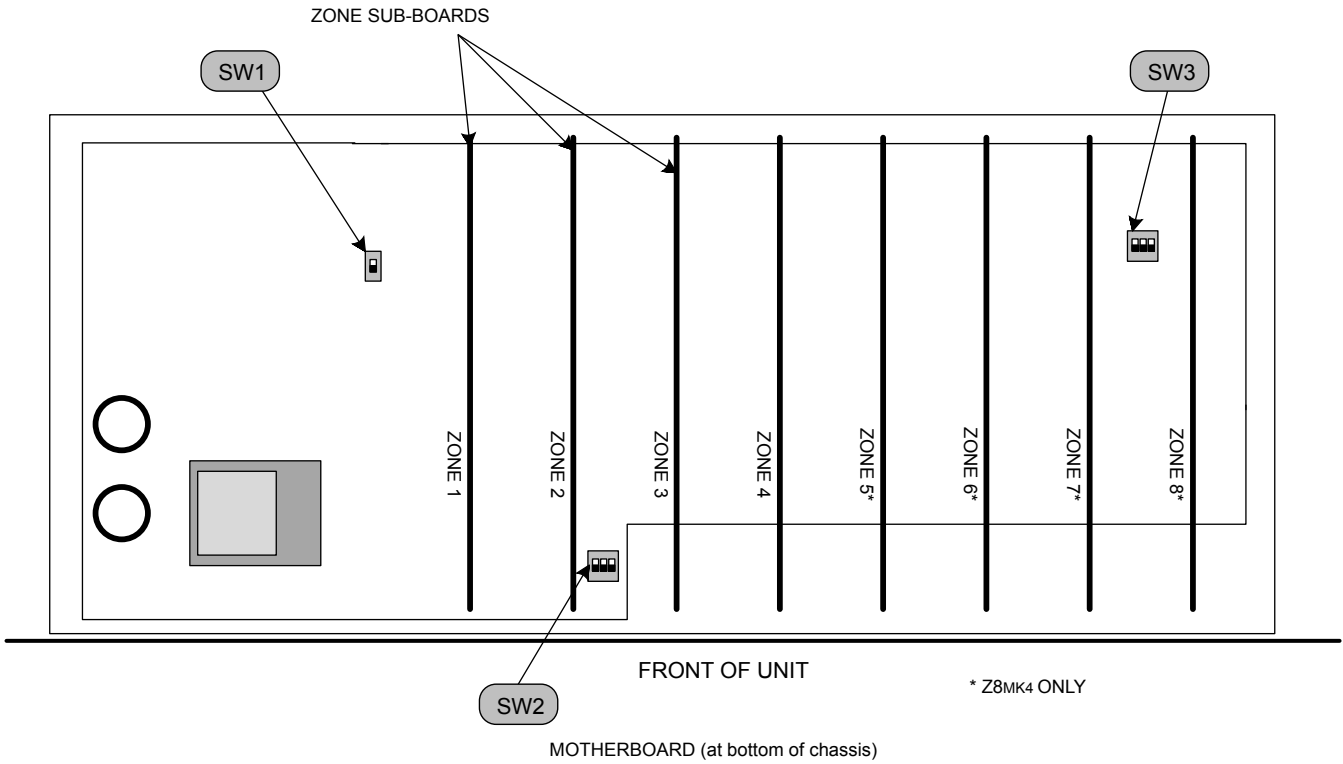

Motherboard jumper locations

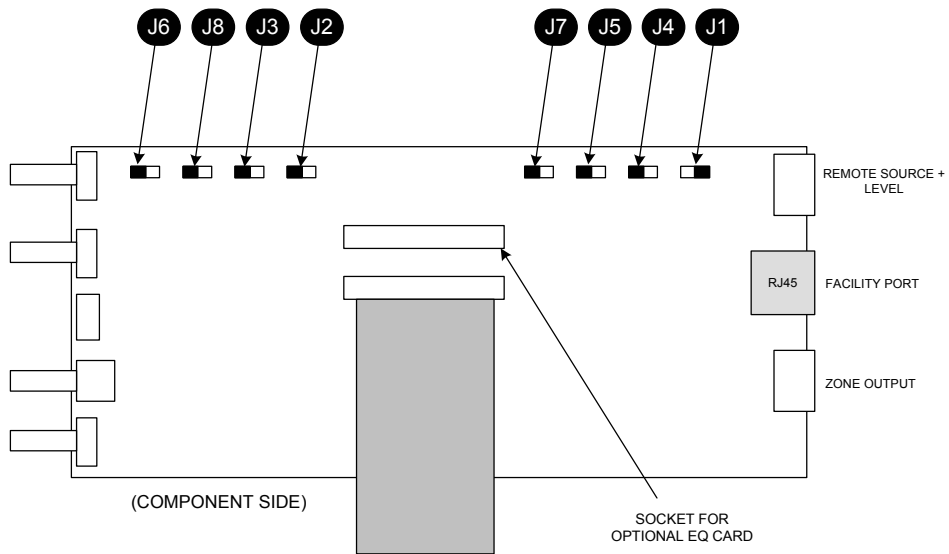

KEY:
 Jumper with two possible positions; black square indicates factory default setting.

Zone sub-board jumper locations

PSU capability and optional device current consumption

In addition to supplying the Zone Mixer's circuitry, the internal PSU has the capacity to power some additional items which may form part of a complete system. These include LM-2 active remote input modules (via the Facility Port), loudspeaker EQ cards (fitted internally), and possibly a PM Series paging microphone (powered via the Access Port).

The maximum current capacity of the PSU available for powering external items is 600 mA.

Current consumption of the various items is listed in the table below.

ITEM	CURRENT PER UNIT
LM-2 mic/line input module	20 mA
PM-4 paging microphone	72 mA
PM-8 paging microphone	83 mA
PM-12 paging microphone	95 mA
PM-16 paging microphone	107 mA
Loudspeaker EQ cards (each)	6 - 34 mA*

*Model-dependent. See separate datasheets at www.cloud.co.uk

The installer should ensure that the total current drawn by all the external items in a system does not exceed 600 mA.

Note that PSU performance will be degraded at ambient temperatures in excess of 35°C.

Ground loops

If, despite your best efforts, the completed sound system 'hums' you probably have a 'ground loop'. The offending signal source can often be identified by setting the volume control to minimum, then disconnecting the input leads (both left & right channels) on each line input until the 'hum' disappears. This problem is often caused by terminating a screened input cable into a signal source positioned a significant distance from the mixer. A good way of avoiding this potential problem is to use signal sources (CD players and the like) that are double insulated with no connection to the mains supply earth. If a signal feed were derived from a second mixer (a club or microphone mixer for example) it would be perfectly normal to expect this to be earthed; we suggest that a transformer be used to isolate the signal and prevent a noisy loop (see page 10).

EMC considerations

The Cloud Z8MK4 & Z4MK4 fully conform to the relevant electromagnetic compatibility (EMC) standards and are technically well behaved; you should experience no operational problems and under normal circumstances, no special precautions need to be taken. If the unit is to be used within close proximity to potential sources of HF disturbance such as high power communications transmitters, radar stations and the like, the performance of the mixer may be reduced; we suggest that the microphone cable screen be connected to the equipment chassis and the line input leads are kept as short as possible.

Technical Specifications

		Z4MK4 & Z8MK4
Line Inputs:		
Frequency Response	20 Hz – 20 kHz ± 0.5 dB	
Distortion	<0.08% 20 Hz - 20 kHz	
Sensitivity	-11 dBu (218 mV) to +12.5 dBu (3.2V), ± 0.5 dBu	
Input Gain Control	20 dB (unbal i/p's); 22 dB (bal i/p's)	
Input Impedance	47 kohms	
Headroom	>20 dB	
Noise	-90 dB A weighted (0 dB gain)	
Equalisation	HF: ± 10 dB @ 10kHz, LF: ± 10 dB @ 50 Hz	
Microphone Inputs:		
Frequency Response	100 Hz / -3 dB (filter) 20 kHz ± 0.5 dB	
Distortion	<0.03% 20 Hz – 20 kHz	
Gain Range	10 dB – 50 dB	
Input Impedance	>2 kohms (balanced)	
Phantom power	+12 V (Internal DIP switch for on/off)	
Headroom	>20 dB	
Noise	-120 dB EIN 22 Hz - 22 kHz (150 ohms)	
Equalisation	HF: ± 10 dB @ 5 kHz, LF: ± 10 dB @ 100 Hz Fixed High Pass Filter: 3rd. order (18 dB/oct) @ 100 Hz	
Facility Input:		
Input Impedance	10 kohms (balanced); pin 3 (+), pin 4 (-)	
Sensitivity	0 dBu (775 mV)	
Noise Gate	Use J4 to disable	
Outputs:		
Balanced Zone Outputs	775 mV (0 dBu), 3-pin screw terminal connector	
Minimum load impedance	600 ohms	
Maximum output level	+20 dBu (7.75V)	
General:		
	Z4MK4	Z8MK4
Power input	85 V to 253 V AC, 47 - 63 Hz	
Fuse rating	250 V – T1A H (high breaking capacity)	
Fuse type	20 mm x 5 mm 250 V	
Dimensions (WxHxD)	482.6 mm x 132.5 mm (3U) x 160.0 mm 19" x 5.25" (3U) x 6.3"	
Weight	3.25 kg net 7.28 lbs	3.60 kg net 8.06 lbs

www.cloud.co.uk



www.cloudusa.pro