

Cloud

CONTRACTOR SERIES

VA SERIES AMPLIFIERS MODELS VA2120 AND VA4120

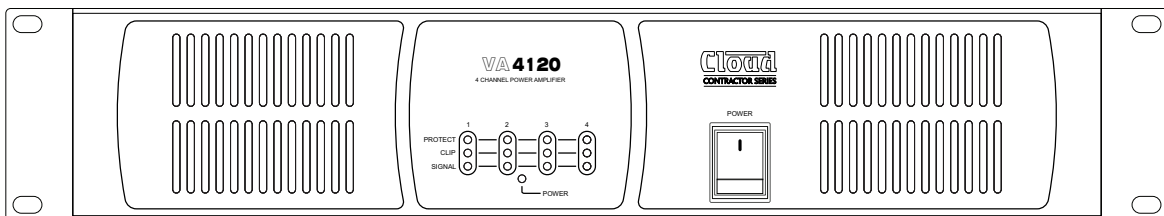

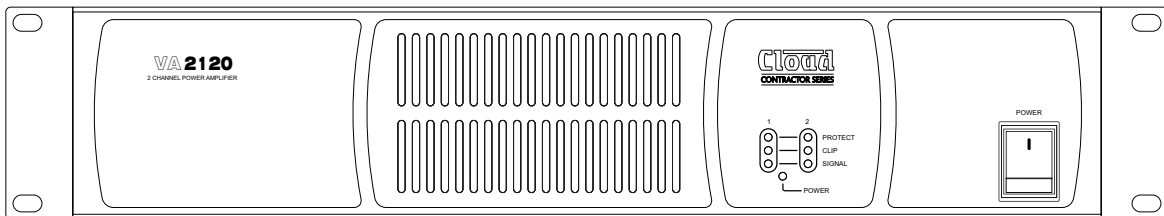

INSTALLATION GUIDE

WARNING:

To reduce the risk of fire or electric shock, do not expose this appliance to rain or moisture.

CAUTION:

Use of controls or adjustments or performance of procedures other than those specified may result in hazardous radiation exposure.

 <p>CAUTION RISK OF ELECTRIC SHOCK DO NOT OPEN</p>	<p>WARNING: SHOCK HAZARD – DO NOT OPEN AVIS: RISQUE DE CHOC ELECTRIQUE – NE PAS OUVRIR</p>
	<p>The lightning flash with the arrowhead symbol within an equilateral triangle, is intended to alert you to the presence of uninsulated dangerous voltages within the product’s enclosure that may be of sufficient magnitude to constitute a risk of electric shock.</p>
	<p>The exclamation point within an equilateral triangle is intended to alert the user to the presence of important operating and maintenance (servicing) instructions in the literature accompanying the appliance.</p>

IMPORTANT SAFETY INSTRUCTIONS

1. Read these Instructions.
2. Keep these Instructions.
3. Heed all Warnings.
4. Follow all Instructions.
5. Do not use this apparatus near water.
6. Clean only with a dry cloth.
7. Do not block any ventilation openings. Install in accordance with the manufacturer's instructions.
8. Do not install near any heat sources such as radiators, heat registers, stoves or other apparatus (including amplifiers) that produce heat.
9. Do not defeat the safety purpose of the polarized or grounding - type plug. A polarized plug has two blades with one wider than the other. A grounding type plug has two blades and a third grounding prong. The wide blade or the third prong are provided for your safety. When the provided plug does not fit into your outlet, consult an electrician for replacement of the obsolete outlet.
10. Protect the power cord from being walked on or pinched particularly at plugs, convenience receptacles, and the point where they exit from the apparatus.
11. Only use attachments/accessories specified by the manufacturer.
12.  Use only with the cart, stand, tripod, bracket or table specified by the manufacturer or sold with the apparatus, when a cart is used, use caution when moving the cart/apparatus combination to avoid injury from tip-over.
13. Unplug this apparatus during lightning storms or when unused for long periods of time.
14. Refer all servicing to qualified service personnel. Servicing is required when the apparatus has been damaged in any way, such as power-supply cord or plug is damaged, liquid has been spilled or objects have fallen into the apparatus, the apparatus has been exposed to rain or moisture, does not operate normally, or has been dropped.



Do not expose the apparatus to dripping or splashing, and ensure that no objects filled with water, such as vases, are placed on the apparatus.

L'appareil ne doit être exposé aux écoulements ou aux éclaboussures et aucun objet ne contenant de liquide, tel qu'un vase, ne doit être placé sur l'appareil.



The mains plug is used as the disconnect device and it should remain readily accessible during intended use. In order to isolate the apparatus from the mains, the mains plug should be completely removed from the mains outlet socket.

Le prise du secteur ne doit pas être obstruée ou doit être facilement accessible pendant son utilisation. Pour être complètement déconnecté de l'alimentation d'entrée, la prise doit être débranchée du secteur.



This apparatus is of Class I construction and must only be connected to a mains outlet socket with a protective earthing connection.



Terminals marked with the ⚡ symbol may use Class 2 Wiring, but voltages at these terminals may be of sufficient magnitude to constitute a risk of electric shock. The external wiring connected to these terminals requires installation by an instructed person or the use of pre-made leads or cords.

Safety Information

Safety Notes regarding Installation

- Do not expose the unit to water or moisture.
- Do not expose the unit to naked flames.
- Do not block or restrict any air vent.
- Do not operate the unit in ambient temperatures above 35°C
- Do not touch any part or terminal carrying the hazardous live symbol ⚡ while power is supplied to the unit.
- Do not perform any internal adjustments unless you are qualified to do so and fully understand the hazards associated with mains-operated equipment.
- The unit has no user-serviceable parts. Refer servicing to qualified service personnel.
- If the moulded plug is cut off the AC power lead for any reason, the discarded plug is a potential hazard and should be disposed of in a responsible manner.

Conformities

This product conforms to the following European EMC Standards:

EN 55032:2015 - Emissions

EN 55035:2017 - RF Immunity

EN 61000-3-3:2013 - Supply voltage tolerance

EN 61000-3-2:2018 - Harmonics

EN 62368-1:2018 - Electrical safety



Safety Considerations and Information

Cloud VA Series amplifiers must be earthed. Ensure that the mains power supply provides an effective earth connection using a three-wire termination.

Caution – High Voltage

Do not touch any part or terminal carrying the hazardous live symbol ⚡ while power is applied to the unit. Terminals to which the hazardous live symbol refers require installation by a qualified person.

Caution – Mains Fuse

Mains over-current protection is provided by the user-replaceable fuse in the IEC receptacle. Only replace this fuse with one of an identical type and rating:

	230 V versions	115 V versions
Fuse type	T4AH time-delay	T8AH time-delay
Fuse size	5 mm dia x 20 mm	
Fuse rating	4 A	8 A

Caution – Servicing

The unit contains no user-serviceable parts. Refer servicing to qualified personnel. Do not perform servicing unless you are qualified to do so. Disconnect the power cable from the unit before removing the top panel and do not make any internal adjustments with the unit switched on. Only reassemble the unit using bolts/screws identical to the original parts.

Important

Read this before connecting the amplifier to AC mains

VA Series amplifiers are pre-configured at the factory to operate on either a 115 V or a 230 V AC mains supply. Before applying power to the unit, please check the rear panel to ensure that the version you have is correctly set for your local supply voltage.

The **MAINS VOLTAGE SELECTOR** switch on the rear panel will show either **230V** or **115V**, as shown below. The warning sticker above the switch will confirm the factory setting.

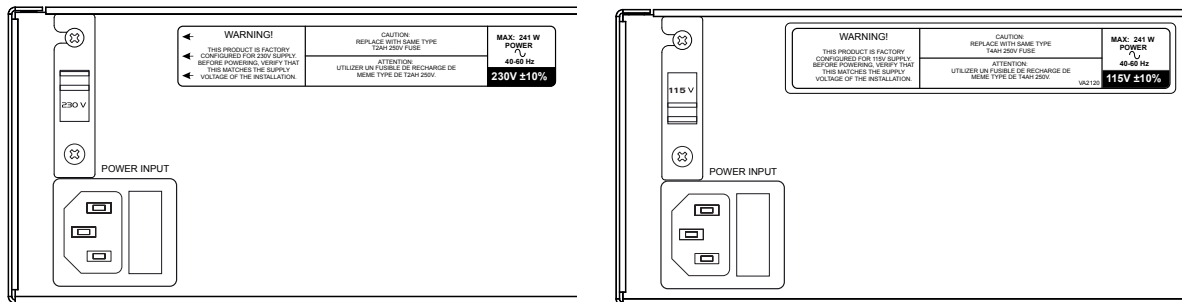

DO NOT CONNECT YOUR VA SERIES AMPLIFIER TO AN AC SUPPLY WITHOUT FIRST VERIFYING THE VOLTAGE SETTING.

Introduction

The Cloud VA2120 and VA4120 are cost-effective audio power amplifiers for use in all types of commercial premises. They have been designed to be as simple to install and operate as possible.

The two models are identical in terms of facilities, and differ only in the number of channels: two (VA2120) or four (VA4120). Each channel can deliver 120 W. The amplifiers can drive either low-impedance loudspeakers directly (4 ohms minimum) or 25/70/100 V-line loudspeaker distribution systems via the tapped secondary winding of the internally fitted line transformer. Both models of amplifier are shipped ready for connection to 25/70/100 V-line systems. Instructions on converting the outputs for low-impedance operation can be found on page 8.

The amplifiers incorporate a limiter in each channel to protect both the output stage and loudspeakers. This reduces excessive signal levels to ensure that clipping does not occur. Further protection circuitry disconnects the output if the maximum permitted internal temperature is exceeded, or if DC is detected at the output terminals.

All connections are made on the rear panel, using detachable screw-terminal type connectors (Phoenix-compatible). Each channel has a preset level control and a switchable high-pass filter to mitigate the effect of transformer saturation at low frequencies when driving 25/70/100 V-line systems.

The front panel has a set of LEDs for each channel, confirming signal presence, excessive level and amplifier protection activity. Both models are forced-air cooled by fans mounted on the rear panel; airflow is front-to-rear.

Rear panel – connections and controls

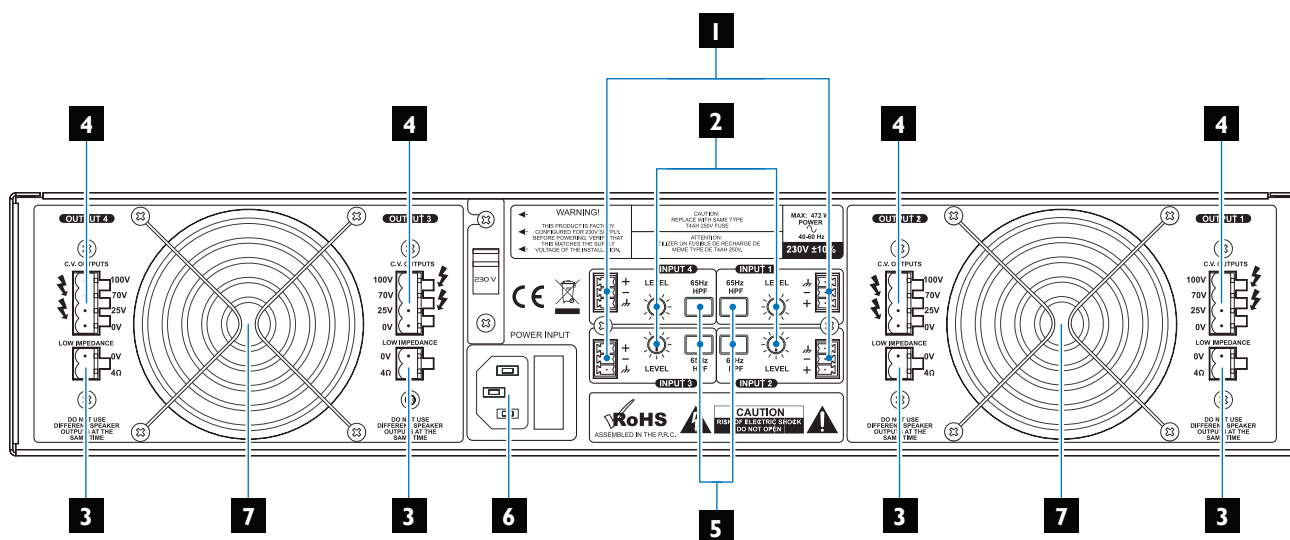

VA 4120

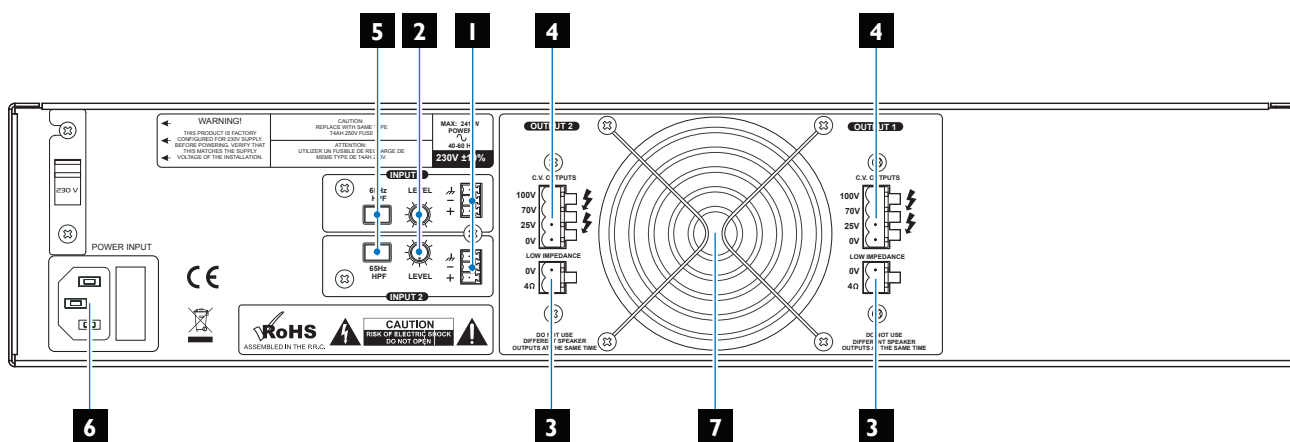

VA 2120

- INPUT 1, INPUT 2** (both models) and **INPUT 3, INPUT 4** (VA4120 only) – balanced line inputs for each amplifier channel, using 3-pin, 3.5 mm-pitch screw-terminal connectors. Mating connectors are supplied. Connect balanced or unbalanced sources according to the diagrams below:

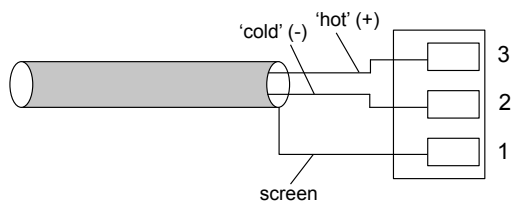

Connecting a balanced source

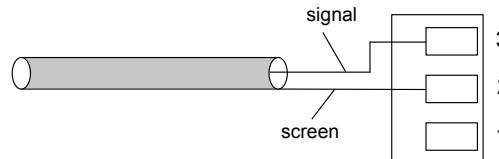

Connecting an unbalanced source

- LEVEL 1, LEVEL 2** (both models) and **LEVEL 3, LEVEL 4** (VA4120 only) – preset-type level controls for each channel. With the control fully anticlockwise, the channel will effectively be off: with the control fully clockwise, the channel will deliver its full nominal power for an input of 0 dBu (0.775 Vrms). The correct setting for the level controls will vary with each installation, but will be determined by the number and power rating of the loudspeakers in use and also on the source equipment. As a point of general guidance, set the level controls so that the sound level is neither distorted nor louder than required, with any level controls on the source equipment at their maximum setting.

NOTE



For each channel, the two output connectors ([3] and [4] below) have a single removable safety cover which should be removed (two screws) to make the connections, and then refitted.

- LOW IMPEDANCE** – a per-channel output for driving low-impedance loudspeakers. The connector type is a 2-pin 5 mm-pitch screw-terminal type: a mating connector is supplied. If connecting multiple loudspeakers, installers must ensure that the total impedance of the load on each channel is not less than 4 ohms. These outputs are not operational when the amplifier is shipped. They may be made operational by moving internal connectors - see page 8.
- C.V. OUTPUTS** – per-channel output for driving 25/70/100V-line loudspeaker distribution systems. The connector type is a 4-pin 5 mm-pitch screw-terminal type: a mating connector is supplied. Only make connections to the 0V terminal and one other, depending on the voltage rating of the system in use. These are the amplifier's default outputs.



Do not attempt to make connections to this output while the mixer-amplifier is powered, as there may be voltages present at the terminals of sufficient magnitude to cause an electric shock.

IMPORTANT

Only the **LOW IMPEDANCE** output [3] or the **C.V OUTPUT** [4] for each channel can be active at any one time. The two output types cannot be used simultaneously for any one channel.

- 65 HZ HPF** – these push-buttons enable an internal, per-channel high-pass filter, limiting the LF content of the signal in order to reduce the possibility of transformer core saturation.
- POWER INPUT** – connect AC mains here using the cable supplied, which will have a mains plug suitable for your territory. Only use a 3-wire connection, to ensure the unit is earthed (grounded). The **POWER INPUT** connector incorporates a fuse holder – see page 4 for fuse data.
- Fans** – VA Series amplifiers are force-air cooled: the VA2120 has a single fan, the VA4120 has two. Ensure there is adequate space at the rear of the chassis for airflow and that the fans are not obstructed. The internal protection circuitry incorporates temperature sensing, and the amplifier will shut down in the event of overheating.

Internal Settings



WARNING – DANGER

Changing the internal settings requires to open the unit. Prior to opening the unit, the unit shall be disconnected from any AC supply. Any work on an open unit shall be expedited only by qualified, certified personnel.

Output configuration (hi-voltage/low-impedance)

Each channel of a VA Series amplifier may be configured EITHER for driving low impedance loudspeakers (4 ohms minimum), or for driving 25/70/100 V-line loudspeaker systems.

Amplifiers are shipped with all channels configured for driving 25/70/100 V-line systems. To convert a channel to low-impedance operation:

- Disconnect the amplifier from the AC mains supply.
- Remove the top lid.
- Identify the output transformer(s) for the channel(s) to be converted from the diagrams below:

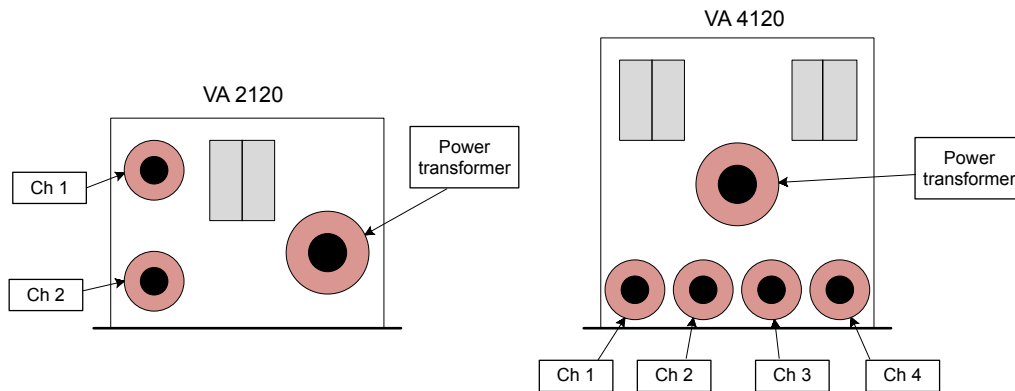

Each transformer’s windings terminate in a pair of in-line, multipin connectors. The primary winding (red and black wires) terminates in a 2-pin female connector, and the secondary winding (blue, white, yellow and purple wires) terminate in a 4-pin female connector. Unplug the 2-pin connector: the mating male part of it (also red and black wires) is the power amplifier output. See diagram below:

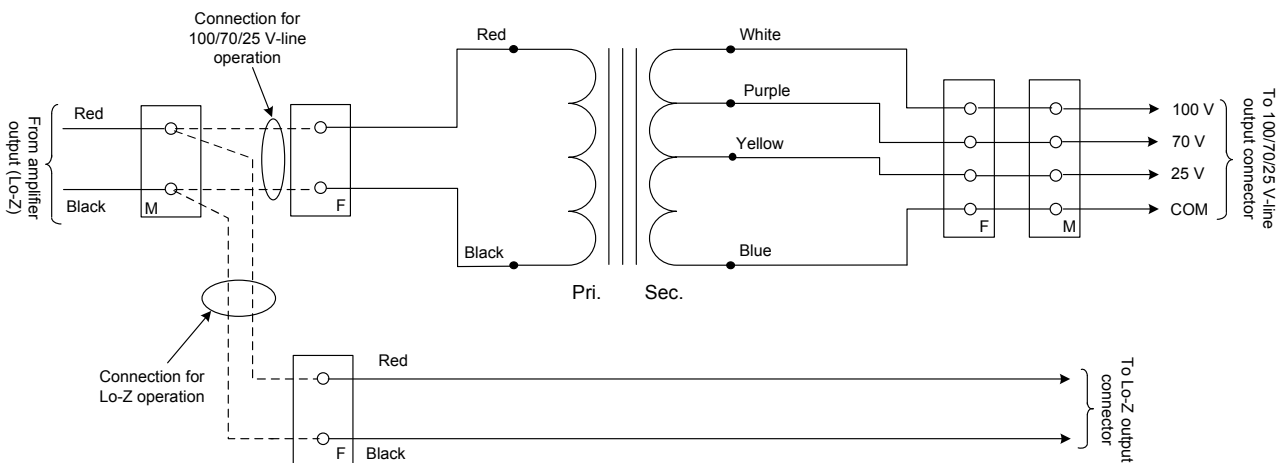

- Identify the red and black pair of wires from the low-Z output terminals: these also terminate in a 2-pin female connector, currently unplugged. Plug this into the male amplifier output connector from the previous step.
- Repeat the above procedure for any other channel(s) requiring conversion to low-impedance operation.
- Replace the top lid.

If at any time it is necessary to convert a low-impedance output back to 25//70/100 V-line operation, reverse the above procedure, reconnecting the amplifier output to the transformer primary.

Front panel – connections and controls

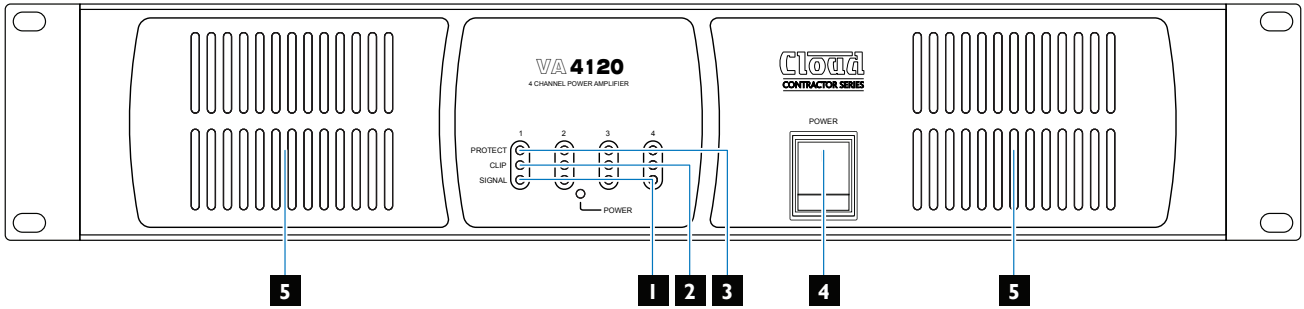

VA 4120

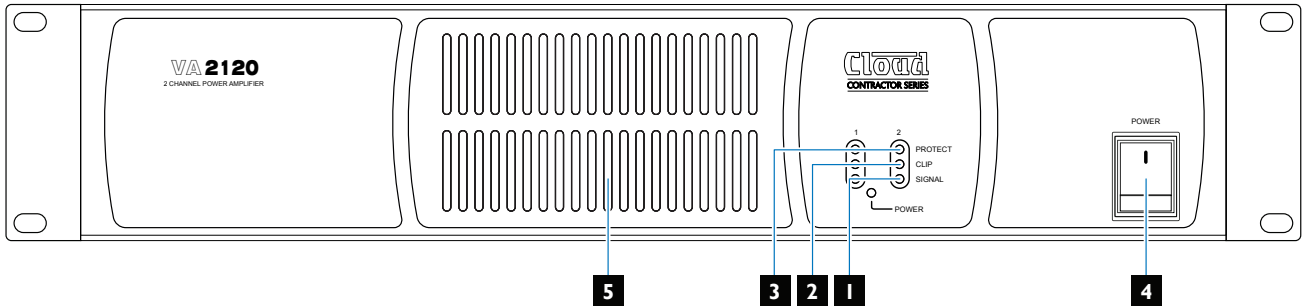

VA 2120

1. **SIGNAL** – a green LED for each channel which illuminates when the channel’s signal level is above -45 dB relative to the maximum power output. In most installations, it can be used to confirm that the channel’s source is active.
2. **CLIP** – an amber LED for each channel which illuminates when the channel’s signal level is within 1 dB of nominal peak power. If this LED flashes more than occasionally, it is likely to indicate that the limiter is active and that the signal level should be reduced, either at the rear panel **LEVEL** control for the channel, or at the source itself.
3. **PROTECT** – a red LED for each channel which indicates a fault condition: it illuminates when the channel’s protection circuitry is active. If this occurs, the output terminals are temporarily disconnected until the fault condition clears. The protection circuitry will be triggered either by over-temperature within the amplifier, or by the detection of DC at the output terminals.
4. **POWER** – turns the mixer-amplifier on and off. When it is on, the green **POWER** LED is illuminated.
5. **Air intakes** – airflow through the mixer-amplifier is from front-to-back. The VA2120 has a single front panel vent, the VA4120 has two. Do not allow the vents to become blocked, as over-temperature will cause the protection circuitry to shut the amplifier down.

Technical Specifications

Line Inputs			
Frequency Response	20 Hz to 20 kHz, ± 1 dB		
Input impedance	47 kohms		
Headroom	16 dB		
Noise	<-85 dB (22 kHz bandwidth)		
Speaker Output			
Output Power (1 kHz continuous sine wave)	VA2120	2 x 120 watts	
	VA4120	4 x 120 watts	
Minimum load	Low-Z output	4 ohms	
	High-Z output	25 V-line	5.2 ohms
		70 V-line	41 ohms
		100 V-line	83 ohms
Frequency response	Low-Z output	20 Hz to 20 kHz, ± 1 dB	
	High-Z output	20 Hz to 20 kHz, ± 1 dB (hi-pass filter off)	
THD + N	< 0.05% @ 1 kHz		
Protection	Fixed level signal limiter: DC, over-current and over-temperature protection		
General			
Power input	Selectable 115 VAC or 230 VAC, $\pm 10\%$; 45 – 65 Hz		
Fuse details	5 x 20 mm, time delay	230 V models	4 A
		115 V models	8 A
Normal operating temperature	0 °C to 35 °C (Note: performance and specifications cannot be guaranteed outside of this range)		
Cooling	Forced air cooling: 1 x 80 mm dia. fan (VA2120); 2 x 80 mm dia. fans (VA4120). Airflow direction: front-to-back		
Power Consumption	Idle ¹	VA2120	14 W (20.8 VA)
		VA4120	27.5 W (39.8 VA)
	1/8 th Power ²	VA2120	206 W (260 VA)
		VA4120	418 W (525 VA)
	1/3 rd Power ³	VA2120	230 W (280 VA)
		VA4120	562 W (685 VA)
Heat Loss	Idle ¹	VA2120	50 KJ/hr (47.5 BTU/hr)
		VA4120	99 KJ/hr (93.9 BTU/hr)
	1/8 th Power ²	VA2120	630 KJ/hr (598 BTU/hr)
		VA4120	1,288 KJ/hr (1,221 BTU/hr)
	1/3 rd Power ³	VA2120	683 KJ/hr (648 BTU/hr)
		VA4120	1,591 KJ/hr (1,508 BTU/hr)
Dimensions (W x H x D)	Net	VA2120	482.6 mm x 88 mm (2U) x 310 mm 19" x 3.5" x 12.2"
		VA4120	482.6 mm x 88 mm (2U) x 408 mm 19" x 3.5" x 16.1"
	Shipping (Gross)	VA2120	570 mm x 170 mm x 430 mm 22.5" x 6.7" x 16.9"
		VA4120	580 mm x 170 mm x 545 mm 22.8" x 6.7" x 21.5"
Weights	Net	VA2120	10.9 kg (24.4 lbs)
		VA4120	18.2 kg / 40.8 lbs
	Shipping (Gross)	VA2120	13 kg (29.1 lbs)
		VA4120	20.3 kg / 45.5 lbs

Notes re Power Consumption and Heat Loss measurements:

All measurements at 230 VAC 50 Hz power input

1. Idle: amplifier active, but no audio output
2. 1/8th Power: constant sound level at one-eighth maximum rated output per channel (audio mainly clean, only occasional clipping)
3. 1/3rd Power: constant sound level at one-third maximum rated output per channel (audio beginning to become compressed, limited or heavily clipped)

www.cloud.co.uk

Cloud
CONTRACTOR SERIES

www.cloudusa.pro