

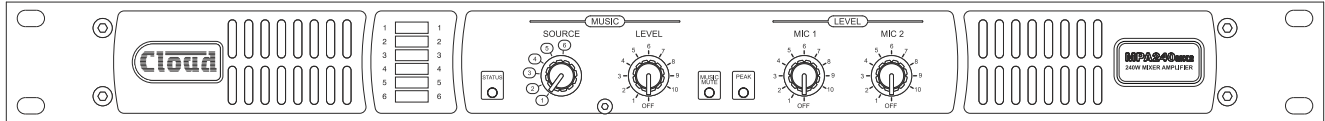



MPA MK2 SERIES SINGLE ZONE MIXER-AMPLIFIERS



Installation and User Guide

WARNING:

To reduce the risk of fire or electric shock, do not expose this appliance to rain or moisture.

 <p>CAUTION RISK OF ELECTRIC SHOCK DO NOT OPEN</p>	<p>WARNING: SHOCK HAZARD – DO NOT OPEN AVIS: RISQUE DE CHOC ELECTRIQUE – NE PAS OUVRIR</p>
	<p>The lightning flash with the arrowhead symbol within an equilateral triangle is intended to alert you to the presence of uninsulated dangerous voltages within the product's enclosure that may be of sufficient magnitude to constitute a risk of electric shock.</p>
	<p>The exclamation point within an equilateral triangle is intended to alert the user to the presence of important operating and maintenance (servicing) instructions in the literature accompanying the appliance.</p>

IMPORTANT SAFETY INSTRUCTIONS

1. Read these Instructions.
2. Keep these Instructions.
3. Heed all Warnings.
4. Follow all Instructions.
5. Do not use this apparatus near water.
6. Clean only with a dry cloth.
7. Do not block any ventilation openings. Install in accordance with the manufacturer's instructions.
8. Do not install near any heat sources such as radiators, heat registers, stoves or other apparatus (including amplifiers) that produce heat.
9. Do not defeat the safety purpose of the polarized or grounding - type plug. A polarized plug has two blades with one wider than the other. A grounding type plug has two blades and a third grounding prong. The wide blade or the third prong are provided for your safety. When the provided plug does not fit into your outlet, consult an electrician for replacement of the obsolete outlet..
10. Protect the power cord from being walked on or pinched particularly at plugs, convenience receptacles, and the point where they exit from the apparatus.
11. Only use attachments/accessories specified by the manufacturer.
12.  Use only with the cart, stand, tripod, bracket or table specified by the manufacturer or sold with the apparatus, when a cart is used, use caution when moving the cart/apparatus combination to avoid injury from tip-over.
13. Unplug this apparatus during lightning storms or when unused for long periods of time.
14. Refer all servicing to qualified service personnel. Servicing is required when the apparatus has been damaged in any way, such as power-supply cord or plug is damaged, liquid has been spilled or objects have fallen into the apparatus, the apparatus has been exposed to rain or moisture, does not operate normally, or has been dropped.



Do not expose the apparatus to dripping or splashing, and ensure that no objects filled with water, such as vases, are placed on the apparatus.

L'appareil ne doit être exposé aux écoulements ou aux éclaboussures et aucun objet ne contenant de liquide, tel qu'un vase, ne doit être placé sur l'appareil.



The mains plug is used as the disconnect device and it should remain readily accessible during intended use. In order to isolate the apparatus from the mains, the mains plug should be completely removed from the mains outlet socket.

Le prise du secteur ne doit pas être obstruée ou doit être facilement accessible pendant son utilisation. Pour être complètement déconnecté de l'alimentation d'entrée, la prise doit être débranchée du secteur.



This apparatus is of Class 1 construction and must only be connected to a mains outlet socket with a protective earthing connection.



Terminals marked with the ⚡ symbol may use Class 2 Wiring, but voltages at these terminals may be of sufficient magnitude to constitute a risk of electric shock. The external wiring connected to these terminals requires installation by an instructed person or the use of pre-made leads or cords.

Contents

IMPORTANT SAFETY INSTRUCTIONS	3
SAFETY INFORMATION	6
Safety Notes regarding Installation	6
Conformities.....	6
RoHS and WEEE declaration	6
Safety Considerations and Information.....	6
Caution – High Voltage	6
Caution – Mains Fuse	6
Caution – Servicing.....	6
OVERVIEW	7
Introduction.....	7
Applicable Models.....	7
MPA MK2 Series main features	7
What’s in the box.....	8
Schematic Diagram	9
Front panel description	10
Rear panel description.....	11
INSTALLATION	13
Hardware considerations.....	13
Ventilation	13
Power Supply.....	13
Fuses and ratings	13
Connections and Controls	14
Music Inputs	14
Sensitivity & Gain Control.....	14
Music Source Select	14
Music Level Control	14
Remote Control of Music Source and Level	14
Music Equalisation	15
Music Priority	15
Microphone Inputs.....	15
Gain Control	16
Microphone level control.....	16
Microphone Equalisation	16
Paging control and mic priority.....	17
Microphone Access Input.....	17
Mic 1-over-Mic 2 priority	17
Outputs	18
Speaker Output	18
Connecting to Lo-Z loudspeakers.....	18
Connecting to 70/100 V-line systems.....	18
Auxiliary Output.....	19

Facility Port	19
Connecting an active remote module.....	20
Music Mute (Fire Alarm Interface)	21
Auto Power Down	21
Options and Additional Information	21
Multi-zone Applications	21
Control of music source and level	
via external DC.....	21
Using the Facility Port as an auxiliary input	22
APPENDIX.....	23
PCB jumper locations.....	23
Table of internal jumpers and default settings.....	24
Troubleshooting	25
EMC Considerations	25
Earthing	25
TECHNICAL SPECIFICATIONS	26

SAFETY INFORMATION

Safety Notes regarding Installation

- Do not expose the unit to water or moisture.
- Do not expose the unit to naked flames.
- Do not block or restrict any air vent.
- Do not operate the unit in ambient temperatures above 35°C
- Do not touch any part or terminal carrying the hazardous live symbol ⚡ while power is supplied to the unit.
- Do not perform any internal adjustments unless you are qualified to do so and fully understand the hazards associated with mains-operated equipment.
- The unit has no user-serviceable parts. Refer servicing to qualified service personnel.
- If the moulded plug is cut off the AC power lead for any reason, the discarded plug is a potential hazard and should be disposed of in a responsible manner.

Conformities

This product conforms to the following European EMC Standards:

BS EN 55035:2017 (Immunity)

BS EN 55032:2015 (Emissions)

BS EN 6100-3-2:2-14 (Harmonics)



This product has been tested for use in commercial and light industrial environments. If the unit is used in controlled EMC environments, the urban outdoors, heavy industrial environments or close to railways, transmitters, overhead power lines, etc., the performance of the unit may be degraded.

The product conforms to the following European electrical safety standard:

BS EN 62368-1:2014

RoHS and WEEE declaration

Cloud Electronics Limited manages its business and collaborates with its suppliers to comply with the European Union restriction of the use of certain hazardous substances in electrical and electronic equipment, RoHS Directive (2002/95/EC), that came into force on 1st July 2006, and similar restrictions in other jurisdictions.



The “crossed out wheellie bin” symbol on the product and represented above is there to remind users of the obligation of selective collection of waste. This label is applied to various products to indicate that the product is not to be thrown

away as unsorted municipal waste. At the end of life, dispose of this product by returning it to the point of sale or to your local municipal collection point for recycling of electric and electronic devices.

Customer participation is important to minimize the potential effects on the environment and human health that can result from hazardous substances that may be contained in this product.

Please dispose of this product and its packaging in accordance with local and national disposal regulations, including those governing the recovery and recycling of waste electrical and electronic equipment. Contact your local waste administration, waste collection company or dealer.

Safety Considerations and Information

The unit must be earthed. Ensure that the mains power supply provides an effective earth connection using a three-wire termination.

Caution – High Voltage

Do not touch any part or terminal carrying the hazardous live symbol ⚡ while power is applied to the unit. Terminals to which the hazardous live symbol refers require installation by a qualified person.

Caution – Mains Fuse

Mains over-current protection is provided by the fuse in the IEC receptacle; only replace this fuse with one of an identical type and rating.

If the replacement fuse blows immediately it indicates that the mixer amplifier has developed a fault, which should be referred to competent service personnel.

The MPA MK2 contains no internal user-replaceable fuses.

Caution – Servicing

The unit contains no user-serviceable parts. Refer servicing to qualified personnel. Do not perform servicing unless you are qualified to do so. Disconnect the power cable from the unit before removing the top panel and do not make any internal adjustments with the unit switched on. Only reassemble the unit using bolts/screws identical to the original parts.

OVERVIEW

Introduction

The Cloud MPA MK2 Series are audio mixer-amplifiers with applications in Licensed, Retail, Leisure and similar venues.

Two models are available to suit different output power requirements (120 or 240 watts); otherwise the models have identical facilities.

The mixer-amplifiers have inputs for six stereo line signals and two microphone signals. Front panel controls are provided for music source selection, music level and microphone levels. A multi-function Facility Port allows the connection of remote active input modules.

An extensive selection of pre-set controls is located on the rear panel; primary unit configuration options are selectable using rear panel DIP switches. Certain installation options are set using internal PCB jumpers.

The units are also compatible with standard Cloud remote control plates from the RL and RSL Series.

Applicable Models

This Installation and User Guide describes the installation and operation of the following models:

- Cloud MPA120 MK2: 120 W mono amplifier for 4 ohm loudspeakers or 100/70 V-line loudspeaker systems
- Cloud MPA240 MK2: 240 W mono amplifier for 4 ohm loudspeakers or 100/70 V-line loudspeaker systems

All references to “MPA MK2” throughout this Installation and User Guide may be taken as being applicable to both models.

MPA MK2 Series main features

- Provide amplification and simple control of music, mic sources and paging in a single unit
- Two versions: output power ratings of 120 or 240 W
- Integral two-channel microphone mixer with per-input sensitivity adjustment
- Front panel controls for music source, music level and level of each mic input
- Six (unbalanced) stereo line inputs with individual sensitivity adjustment
- Two balanced mic inputs – 12 V phantom power available on either or both
- Fixed 100 Hz hi-pass mic channel filter
- Separate microphone limiter circuit to prevent power stage limiter from ducking music signal in the presence of high mic levels

- Separate HF/LF EQ adjustments (rear panel) for mic signals and music source
- Paging control on Mic 1 input via short-to-ground access connection
- Mic 1 configurable as high-voltage input for paging from existing 70/100 V-line system
- High-voltage input alternatively selectable to Line 5 input: permits existing background music to be routed via MPA MK2
- Selectable VOX mic-over-music priority on all mic Inputs
- Automatic Mic 1-over-Mic 2 priority in Page mode; may be overridden by internal jumper
- Selectable LINE 6 priority with choice of release times
- Selectable pre-announcement chime
- Music Mute control input (N/O and N/C) for interface to an emergency system
- Facility port for connection of LM-2, L-1 or M-1 remote input modules via screened Cat 5 cable; LM-2 also allows remote control of music level and line input selection
- Facility Port supports BT-1 Bluetooth input module
- Compatible with standard Cloud remote control plates: RL-1 Series (music level) and RSL-6 Series (music level and source selection)
- Power amplifier protection circuitry
- Power amplifier input limiter
- Transformerless output stage can be configured to drive either 70/100 V-line systems directly, or low impedance loudspeakers (4/8 ohms)
- Switchable 65 Hz high-pass filter: reduces transformer saturation in 70/100 V-line systems
- Aux output from pre-amp (balanced, line level)
- Automatic power-down function (user-selectable)
- Convection cooled (MPA120 MK2); forced-air cooling with variable speed control (MPA240 MK2)
- 1U 19” rack mounting unit

Available Options:

- LM-2 remote active mic/line input module with music source selection and volume controls
- BT-1 remote Bluetooth wireless audio input module
- L-1 remote active line input module
- M-1 remote active mic input module
- RL Series remote control plates for music volume
- RSL Series remote control plates for music source selection and level
- PM-1 single zone paging mic

What's in the box

Please check the shipping carton for damage before opening. If there is damage, please contact your Cloud agent and the shippers.

The packing carton should contain the following items:

- MPA MK2 mixer amplifier
- IEC mains lead (AC cord) with moulded plug appropriate to the territory
- Set of mating plug-in screw-terminal connectors
- Set of four plastic feet, with fixings
- This manual

Schematic Diagram

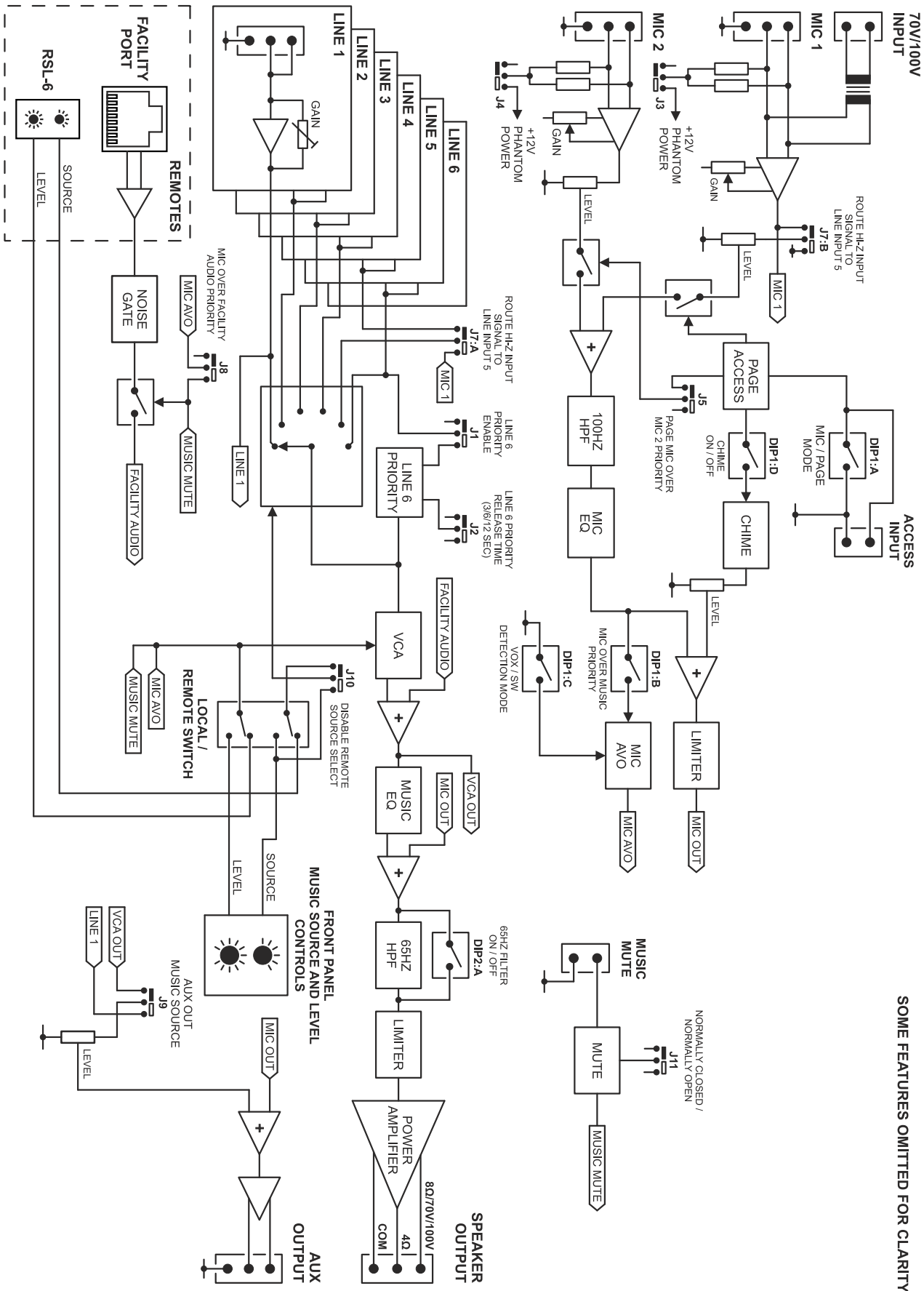

Front panel description

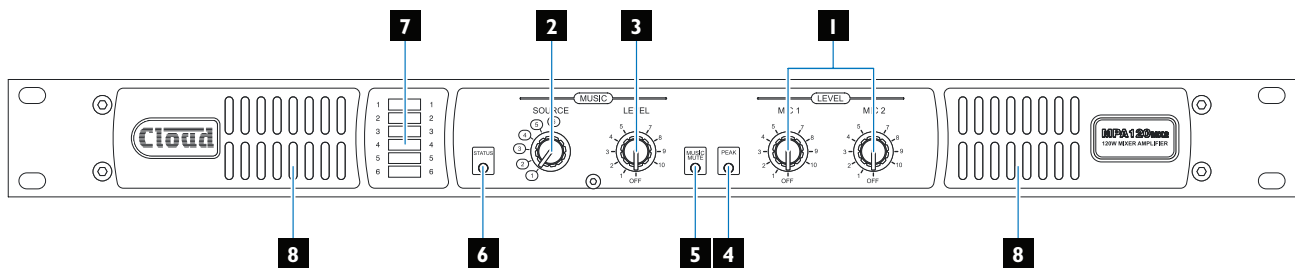

1. **MIC 1 and 2 LEVEL** – level controls for Mic Inputs 1 and 2.
2. **MUSIC SOURCE** – selects active Line Input (1 to 6).
3. **MUSIC LEVEL** – adjusts level of selected Line Input.
4. **PEAK** – red LED: illuminates if either Mic or Line signal levels are too high.
5. **MUSIC MUTE** – red LED: illuminates when external Music Mute is active.
6. **STATUS** – bicolour LED indicates as follows:

INDICATION	MEANING
Off	Power off
Green	Normal operating mode
Red	Standby (APD) mode
Flashing green	Power reduction due to high temperature
Flashing red	Fault condition - outputs muted

7. Space for source ident.
8. Ventilation slots (MPA120 MK2 only), or forced-air cooling air intakes (MPA240 MK2 only) – do not block.

Rear panel description

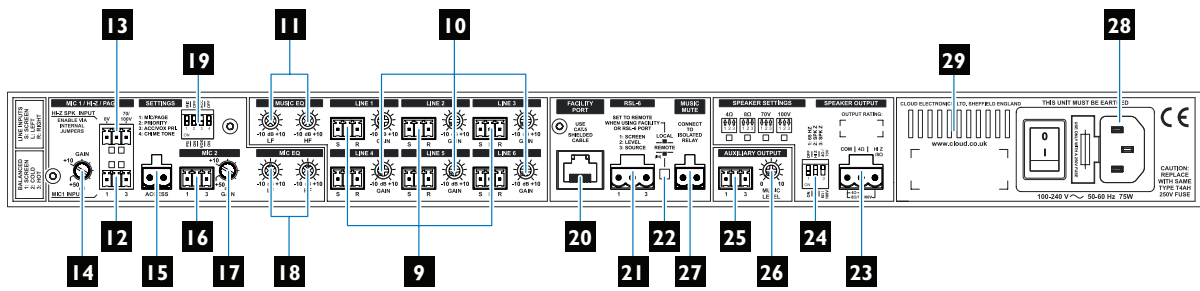

- 9. LINE 1 to LINE 6 – stereo line inputs for music sources.
- 10. GAIN 1 to GAIN 6 – level trims for each line input.
- 11. MUSIC EQ – LF and HF EQ adjustment for music channel.
- 12. MIC 1 INPUT – balanced input for Mic 1.
- 13. HI-Z SPK INPUT – alternative high-voltage input, for connection to 70/100-V line speaker systems.
- 14. GAIN 1 – level trim for Mic input 1.
- 15. ACCESS – external paging control input for Mic 1.
- 16. MIC 2 – balanced input for Mic 2.
- 17. GAIN 2 – level trim for Mic 2.
- 18. MIC EQ – LF and HF EQ adjustment for mic channel.
- 19. SETTINGS – 4-pole DIP switch for configuring Mic Input 1:

SWITCH	NAME	FUNCTION
SW1	MIC/PAGE	MIC 1 mode – configures MIC 1 input for paging use
SW2	PRIORITY	Enables mic-over-music priority
SW3	ACC/VOX PRI.	Selects paging priority mode – VOX or ACC (ACC = contact closure)
SW4	CHIME TONE	Enables pre-announcement chime tone

- 20. FACILITY PORT – RJ45 socket for connection of remote active input/control modules such as the LM-2, BT-1, L-1 and M-1. This port may also be used as an additional balanced line input.
- 21. RSL-6 – for connection of RL-1 or RSL-6 remote control plates.
- 22. LOCAL/REMOTE – press to enable the RSL-6 port and the remote control functions of the Facility Port: disables front panel music controls.
- 23. SPEAKER OUTPUT – connect to either low-Z loudspeakers or to 70/100 V-line distribution system.

24. **SPEAKER SETTINGS** – 3-pole DIP switch for setting output configuration:

SWITCH	NAME	FUNCTION
SW1	65 HZ	Enables 65 Hz high-pass filter (use with 70/100 V-line operation)
SW2	SPK Z	Configures output for low-Z or 70/100 V-line operation
SW3	SPK Z	When SW2 = LO Z: selects output impedance to suit 4 ohm or 8 ohm loudspeakers When SW2 = HI-Z: selects 70 V-line or 100 V-line operation

- 25. **AUXILIARY OUTPUT** – balanced line level output for feeding additional amplifiers, etc.
- 26. **MUSIC LEVEL** – adjust level of music at AUXILIARY OUTPUT.
- 27. **MUSIC MUTE** – Emergency control input for muting music.
- 28. IEC mains input with mains switch and integral fuseholder.
- 29. Ventilation slot (MPA120 MK2 only), or forced-air cooling air exhaust (MPA240 MK2 only) – do not block.

INSTALLATION

Hardware considerations

The MPA MK2 mixer-amplifier is built in a 1U-high 19" rack mount enclosure. It is recommended that it is installed in a 19" rack wherever possible. The units are only 150 mm deep, but it is recommended that at least 100 mm of additional rack depth should be available to allow for rear connectors and cabling.

Fasteners are not supplied with the unit. We recommend the use of standard M6 x 15 panhead screws (4 required), together with M6 captive nuts and plastic cup washers. The weight of the MPA MK2 is sufficiently low for no shelf, side brackets or other additional supporting hardware to be necessary.

The choice of installation location will be dictated by the specifics of the system and building layout. It is recommended that wherever possible, the MPA MK2 should be mounted adjacent to as many of the music sources (CD players, music servers, TV receiver boxes, etc.) as practical.

When deciding the mixer-amplifier's location, bear in mind that access to it (particularly the rear panel) will probably be required even if a full complement of remote controls is being fitted as part of the system, as certain adjustments can only be made on the unit itself.

Ventilation

The MPA120 MK2 is convection-cooled and is silent in operation.

The higher-powered MPA240 MK2 is convection cooled below an amplifier temperature of 45°C, and force-air cooled by a variable-speed fan above this temperature, which reaches its maximum speed at an amplifier temperature of 65°C. Airflow is from front to rear.

Both models have two sets of ventilation slots in the front panels and one set in each of the rear, top and both side panels: ensure that these are kept unobstructed by cabling or any other items. It is recommended that a 1U blank panel is fitted above the MPA MK2 to aid heat dissipation; slotted panels are not recommended in the case of the MPA240 MK2 as they defeat the action of forced-air cooling.

MPA MK2 mixer amplifiers have been designed to operate in an ambient temperature range of 0°C to 35°C. While satisfactory operation outside of this recommended temperature range may be achievable in a particular installation, no guarantee can be given regarding full adherence to the performance specifications (see the Appendix section of this manual). Installers should always endeavour to fit the MPA MK2 in a location where the recommended temperature range is not exceeded. To help achieve this, we recommend that the MPA MK2 is not rack-mounted immediately above other equipment which generates heat (e.g., older designs of power amplifier).

If the unit is to be used free-standing (i.e., not mounted in a rack), the push-rivet plastic feet supplied in the accessory pack should be fitted to the bottom of the enclosure.

Power Supply

The MPA MK2 has an internal power supply of the "universal" type, and will operate on all AC mains supplies of between 100 V and 240 V, 50 to 60 Hz. An IEC mains cable with a plug appropriate for each country is supplied with the unit. MPA MK2 mixer-amplifiers are very energy-efficient and consume less than 10 W in Idle mode; see the Technical Specifications on page 26 for more details.

Fuses and ratings

The only externally-accessible fuse is the AC mains fuse integral with the IEC receptacle on the rear panel. **Only replace a fuse with one of exactly the same type.** The IEC receptacle has space for a spare fuse; one is supplied with the unit.

The table below gives the correct fuse type:

Fuse Type	Fuse size	Rating
T4AH 250V	20 mm x 5 mm	4 A

If a replacement fuse blows immediately, it indicates that the mixer-amplifier has developed a fault, which should be referred to competent service personnel.

Internally, a 20mm x 5mm time-delay 2.5 A fuse protects the amplifier power output module. This is a service component, and should not require attention. Failure of this fuse indicates a fault condition, which should be immediately referred to a competent technician or authorised service centre.

Connections and Controls

Music Inputs

The unit has six stereo line inputs; these inputs are suitable for most music sources such as compact disc players, music servers, laptops, satellite receivers and the like. Each stereo input is summed internally to mono.

All inputs are unbalanced, and use 3-pin 3.5 mm-pitch screw terminal connectors. The input impedance is 47 kohms. Connect as shown below:

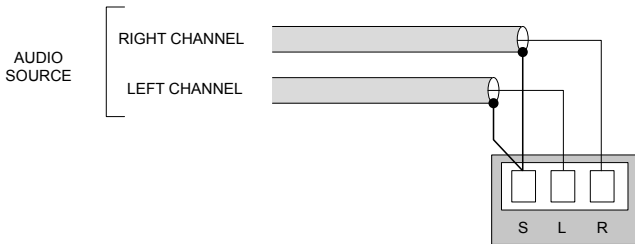

LINE 6 input can be configured to have automatic priority the other music sources: see Music Priority, page 15.

Sensitivity & Gain Control

All six stereo line inputs have a preset **GAIN** control on the rear panel adjacent to the respective input sockets. The control has a range of 20 dB allowing the input sensitivity to be varied from -12 dBu (195 mV) to +8 dBu (2.0 V).

The **GAIN** control should be adjusted so that all the input sources are operating at approximately the same volume, and that the front panel **MUSIC LEVEL** control has a useful range of control.

Music Source Select

The front panel **MUSIC SOURCE** rotary switch is used to select the desired music signal. Remote control of source selection is possible with a remote control plate (RSL-6), or active input module (LM-2), see below and page 20.

Music Level Control

A front panel mounted **MUSIC LEVEL** control is provided.

Remote control of music level is possible with a remote control plate (RSL-6 or RL-1), or active input module (LM-2), see below and page 20.

Remote Control of Music Source and Level

MPA MK2 mixer-amplifiers are compatible with standard Cloud remote control plates: RSL-6 Series (music source select and level) and RL-1 Series (level only).

Either type of plate may be connected at the rear 3-pin, 5 mm-pitch screw terminal connector (RSL-6), using the wiring shown below:

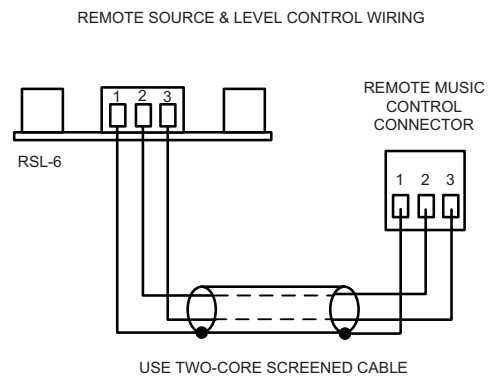
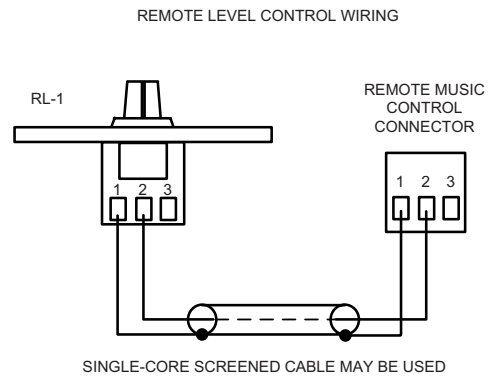

Use two-core (RSL-6 or RL-1) or single-core (RL-1 only) screened cable to connect the remote level plate (max length 100 metres).

Setting the **LOCAL/REMOTE** button adjacent to the **RSL-6** connector to **REMOTE** (button IN) activates the remote control plate and disables both the front panel level and source select controls. If an RL-1 is being used, the internal jumper J10 should be moved from its default 'SW' setting to 'FR', to override the disabling of the front panel source select switch. See page 23 for location of jumpers.

Music Equalisation

Two **MUSIC EQ** controls are provided for the music signals. These preset controls are located on the rear panel adjacent to the line input sockets. The **HF** (treble) control has a range of ± 10 dB at 10 kHz and the **LF** (bass) control has a range of ± 10 dB at 50 Hz.

Note that these controls also affect any signal applied to the unit via the Facility Port: see page 19.

Music Priority

A jukebox, digital sound store or other audio source can be given automatic priority over all other music inputs by connecting it to Line Input 6 and moving internal jumpers J1A and J1B from OFF (factory default position) to ON. When this priority is enabled, the unit will operate normally until a signal is detected at Line Input 6, when the selected source (typically background music) is muted, allowing the source connected to Line 6 to replace it. Once the signal on Line Input 6 stops, the selected source will smoothly restore to its former level. The time taken for the restoration is factory-set to 3 seconds, but may be set to 6 or 12 seconds with internal jumper J2. (3s is suitable for announcements, but the longer times may be more appropriate if a jukebox or similar is connected to Line Input 6.) See page 23 for location of jumpers.

Note that Line 6 priority does not apply to the Facility Port. Remote active modules connected to the MPA MK2 Facility Port will normally have priority (but in the case of the LM-2, see the Installation Guide for further information).

Microphone Inputs

Two microphone inputs are provided; the microphone pre-amplifiers are an electronically balanced, transformerless design configured for optimum low noise performance. The input impedance is greater than 2 kohm and is suitable for microphones in the 200 ohm to 600 ohm range.

Inputs are via separate 3-pin, 3.5 mm-pitch screw terminal connectors on the rear panel.

Mic Input 1 - connections

Mic Input 1 can be configured for paging or announcements. By default, the mic input is independent and is simply mixed with Mic Input 2 and the selected line input: when reconfigured for paging, it operates as a standard Cloud-type paging input, with selectable mic-over-line priority and triggering by either contact closure or automatic signal detection. It is then compatible with paging microphones using zone selection by contact-closure such as the Cloud PM1 single-zone microphone. See page 17 for more details.

Mic Input 1 has two separate physical inputs: a standard balanced input and a high-voltage transformer-isolated input for connection to 70/100 V-line systems. Both inputs are on the **MIC 1/HI-Z/PAGE** connector.

IMPORTANT: Cloud recommend that no attempt is made to connect sources to the balanced and high-voltage inputs simultaneously.

Balanced input

The connector uses the lower three pins of the 2 x 3-pin 3.5 mm-pitch screw terminal type on the rear panel [12]. Use the wiring shown below:

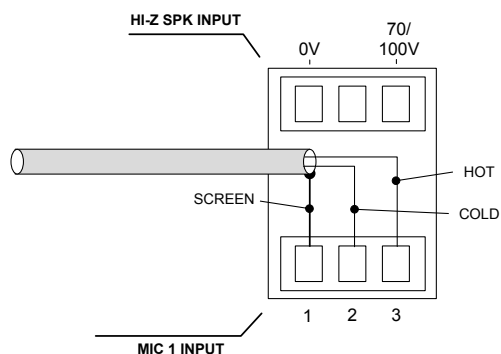

12 V phantom power is available at the mic input, and is activated by setting internal jumper J3 to the ON position. See page 23 for locations of internal jumpers. Care should be taken to ensure that phantom power is activated only when the microphone connected to the input requires it – i.e., a capacitor or electret type; other types of microphones (such as dynamic) may be damaged if a DC voltage is applied to them.

Hi-Z input

Mic Input 1 is provided with a second, alternative method of connection, which by default is routed to the mic channel when selected. This is a high impedance, transformer-isolated input which can be connected directly to a 70 V-line or 100 V-line loudspeaker system. When configured in this way, the mic input can be used to route paging announcements from a building-wide PA or PA/VA system into the area covered by the MPA MK2.

The high-voltage input is enabled by moving internal PCB jumpers J6A, J6B and J6C. All three jumpers must be moved together. See page 23 for details of jumper locations.

The high-voltage input may alternatively be routed internally to the music channel, where it replaces Line Input 5. This means the MPA MK2 can be fed, for example, with background music from a 70/100 V-line system, allowing it to be fully integrated with an existing building system. Also, the music level may be controlled remotely in the same way as when any other input is used for music sources. The internal routing of the Hi-Z input - to the mic channel or Line 5 - is determined by internal jumpers J7A and J7B. The factory default is for the high-voltage input to be routed to the mic channel: moving the jumpers will route it to the music channel. Both jumpers must be moved together. See page 23 for details of jumper locations.

Note that when the high-voltage input is enabled, the balanced mic input [12] will be disconnected; if J7A and J7B are moved to the LINE position, Line Input 5 will also be disconnected.

To use the high-voltage input, connect a 70 V-line or 100 V-line system feed to the 70/100V input, as shown below. The Hi-Z input uses two pins of the upper 3-pin section of the connector.

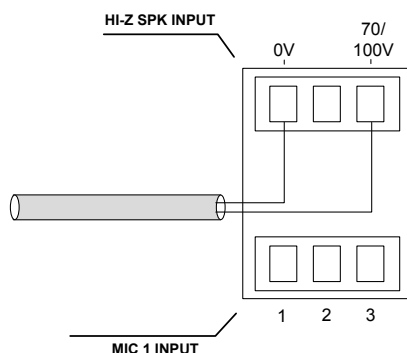

Note that the 70/100 V input is suitable for use with either 70 V-line or 100 V-line systems. The **GAIN** control may be used to adjust for the 3 dB difference in level between the two systems.

Mic Input 2 - connections

Connect microphones as shown below:

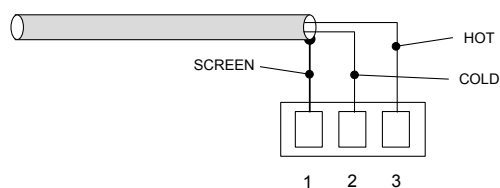

12 V phantom power is available at Mic input 2, and is activated by setting internal jumper J4 to the ON position. See page 23 for locations of internal jumpers. Care should be taken to ensure that phantom power is activated only when the microphone connected to the input requires it – i.e., a capacitor or electret type; other types of microphones (such as dynamic) may be damaged if a DC voltage is applied to them.

Gain Control

Each mic input has a preset **GAIN** control ([14] and [17]) adjacent to the input connector.

The **GAIN** control for Mic Input 1 is operative whichever of the two input types is in use, though with different gain ranges:

- Balanced mic input - gain range 40 dB, from 10 dB to 50 dB.
- Hi-Z input – gain range 10 dB, from 10 dB to 20 dB

Note that the **GAIN** control is still functional when the Hi-Z input is routed internally to Line 5 by moving jumpers J7A and J7B.

Microphone level control

A front panel **LEVEL** control [1] is provided for each mic input and these provide the user with a means of adjusting the volume of each, or the announcements from a PA/VA system if Mic Input 1's high voltage connections are in use. The rear panel **GAIN** controls ([14] and [17]) should be set at a level where distortion does not occur even when the front panel **LEVEL** control is fully clockwise. If the mic level is set too high, the front-panel **PEAK** LED [4] will illuminate. Note that this LED also indicates excessive music level.

Microphone Equalisation

The two microphone inputs are summed together and are routed to the power stage via a fixed high pass filter and an adjustable EQ section. The fixed filter attenuates the signal below 100 Hz, which helps to reduce the effects of microphone handling noise.

The two preset **MIC EQ** controls [18] are on the rear panel adjacent to the mic inputs; the LF and HF controls provide ± 10 dB of adjustment below 100 Hz and above 5 kHz respectively. After installation, some test announcements should be made, ideally by the people who will normally make them. The Mic EQ should be adjusted if necessary to maximise voice clarity.

Paging control and mic priority

Mic Input 1 can be reconfigured to operate as a paging input with the **SETTINGS** DIP switch.

For normal (non-paging) operation, all four switches should be in the 'up' position. The priority functions operate as described below whichever of Mic Input 1's connection options is in use (balanced or Hi-Z).

- **SW1 – MIC/PAGE:** in the MIC position (switch up), Mic 1 input operates as a standard microphone input. In the PG position (switch down), it operates as a typical Cloud paging input. In this mode, the Paging Access contacts will need to be shorted in order for Mic 1 input to become active.
- **SW2 – PRIORITY:** set to ON (switch down) to enable Mic-over-Music priority. This can be selected in both MIC and PAGE modes of Mic Input 1, i.e., regardless of the setting of SW1. The priority function will reduce the level of signals at both LINE and FACILITY inputs by 25 dB. In MIC mode the priority trigger is always VOX; in PAGE mode the priority can be either by access contacts or VOX mode, as selected by SW3. Note that in MIC mode (SW1), Mic-over-Music priority is triggered by a signal at either mic input. When Mic-over-Music priority is active, the music channel is muted: when it is released, the music will fade up over approximately 3 seconds. Note that this priority also mutes any audio signal applied to the unit via the Facility Port.
- **SW3 – ACCESS/VOX PRI.:** Note that this switch is only operational when SW1 is set to PG: with SW1 set to MIC, priority triggering always uses VOX mode. When SW3 is set to ACC (switch up), contact closure priority triggering is selected: a short circuit at the **ACCESS** connector [15] will trigger priority (see below for wiring details), enabling the mic input while 'ducking' any line input signals and muting Mic Input 2 (unless overridden by internal jumper). With the switch down, VOX mode is selected: a signal at Mic 1 input will automatically trigger Mic-over-Music priority. In order for VOX mode to operate when SW1 is set to PG, the two pins of the Paging Access connector must be shorted together.
- **SW4 – CHIME:** MPA MK2 mixer-amplifiers have an internal pre-announcement chime generator. With SW4 set to ON (switch down), the chime is triggered by the **ACCESS** input when Mic Input 1 is in Page mode (SW1 set to PG). The default setting is OFF. An internal preset control is provided to adjust the chime volume; the front panel level controls have no effect on chime level. See page 23 for locations of internal controls.

Microphone Access Input

The paging access control input is on the 2-pin, 5 mm-pitch screw-terminal **ACCESS** connector [15]. The **ACCESS** input provides compatibility with "contact-closure" paging microphones. In PAGE mode, Mic 1 input is muted as long as the pins of the access connector are open-circuit. When the pins are connected together, Mic 1 input becomes active. The internal chime generator will also be activated if SW4 is set to ON.

In either VOX or ACC mode, the music signal is faded back up after the announcement is complete over a period of approx. 3 seconds.

Mic 1-over-Mic 2 priority

If internal jumper J5 is set to ON (the default setting), Mic Input 2 will be muted whenever the **ACCESS** connector pins are shorted with PAGE mode selected (SW1 set to PG). This ensures that Mic Input 1 will always have priority over Mic Input 2 when Mic Input 1 is configured for paging.

If this default setting is overridden by moving J5 to OFF, Mic Input 2 will remain active, and any signal at the input will be mixed with the paging announcement.

Outputs

Speaker Output

The power amplifier stage is fully protected against DC offset, output over-current, and is also thermally protected. Activation of the protection circuitry shuts the power amplifier stage down until the fault condition clears. All protection conditions will automatically self-clear if the amplifier is power-cycled. A switch-on delay function mutes the output during power-up and power-down to protect loudspeakers.

The MPA MK2 has both a low impedance output (4 ohms) and a high voltage output for 70/100 V-line speaker systems. Both outputs are available on the 3-pin 5 mm-pitch screw-terminal **SPEAKER OUTPUT** connector [23].

Only one of the two output options can be used at a time. The output type is selected with **SPEAKER SETTINGS** DIP switch: select SW2 to LO-Z (switch down) for low impedance operation or HI Z (switch up) for 70/100 V-line operation. The switch is set to HI at the factory: set it to the down position if the amplifier is to be use with low impedance loudspeakers.

Connecting to Lo-Z loudspeakers

For low-impedance operation, set SW2 to LO-Z (switch down). The MPA MK2 can deliver its rated power into a 4 ohm or 8 ohm load: set SW3 to 4Ω/70V (switch up) or to 8Ω/100V (switch down) as appropriate. Installers fitting multiple low-impedance loudspeakers (generally 8 ohms) should employ series and parallel wiring to produce a total load impedance of either 4 or 8 ohms, but never less than 4 ohms under any circumstances.

For low-impedance operation, wire the **SPEAKER OUTPUT** connector according to (a) or (b) in the diagram below.

Connecting to 70/100 V-line systems

The MPA MK2 is a transformerless design and can directly drive 70 V-line or 100 V-line loudspeaker systems. The power amplifier stage is rated at 120 W (MPA120 MK2) or 240 W (MPA240 MK2).

Connect to a 70 V-line or 100 V-line speaker system by setting SW2 to HI Z (switch up) and setting SW3 to either 70V (switch up) or 100V (switch down), as required.

Units will be factory-set to 70 V "out of the box": a set of tick boxes is included on the rear panel for installers to confirm what the correct output configuration should be.

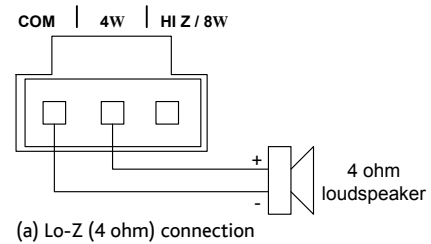

(a) Lo-Z (4 ohm) connection

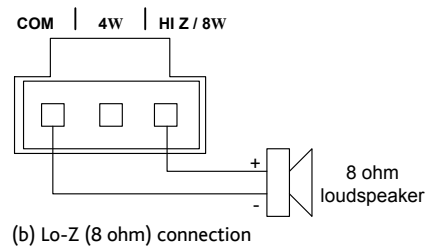

(b) Lo-Z (8 ohm) connection

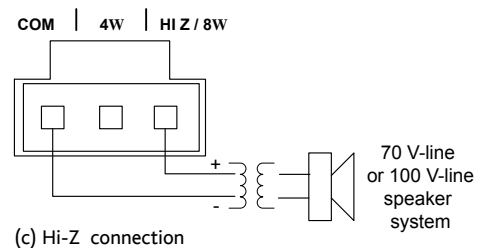

(c) Hi-Z connection

When driving 70/100 V-line loudspeaker systems there is a risk of transformer core saturation at high levels and low frequencies, which can produce distortion. To prevent this, the MPA MK2's output stage is provided with a 65 Hz high-pass filter, which may be enabled by setting **SPEAKER SETTINGS** switch SW1 to on (SWITCH down).

Auxiliary Output

The mixer-amplifier is provided with an **AUXILIARY OUTPUT** [25]. This may be used to drive an additional amplifier, for recording, or any other purpose where system “expansion” is required. The connector is a 3-pin, 3.5 mm-pitch screw terminal type.

The signal at the Auxiliary Output is balanced and line level, and can thus be used to drive most external equipment directly. The wiring is as follows:

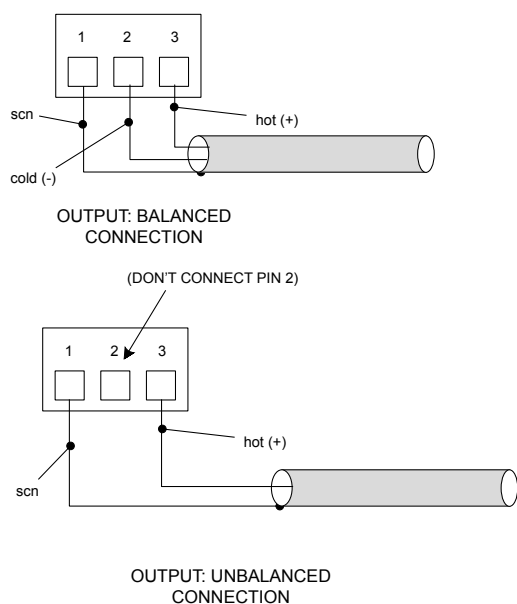

The signal at the **AUXILIARY OUTPUT** connector is a mix of the music and mic channels. The music level at the output can be adjusted with the **MUSIC LEVEL** control [26] adjacent to the connector. By default, the music source will be that present at the amplifier’s main output. Alternatively, the music source may be set to be always that connected to Line Input 1, by moving internal jumper J9 from TRACK to LINE1. If J9 is set to TRACK, the Auxiliary Output will be affected by both Line 6 and Mic-over-Music Priorities: this will not be the case if J9 is set to LINE1. See page 23 for details of PCB jumper locations.

Note that the music signal at the Auxiliary Output is not subject to the action of the Music EQ section, the 65 Hz high-pass filter or the power stage’s dynamic clip protection.

Facility Port

The MPA MK2 mixer-amplifier is provided with a **FACILITY PORT** in the form of a rear panel RJ45 connector [20]. The primary use of the Facility Port is for the connection of remote active modules such as the LM-2 or BT-1, but it may also be used as a general-purpose auxiliary balanced input (see page 22 for more information on this application).

The various optional Cloud remote active modules operate from DC power supplied by the MPA MK2. The current consumed by each module is minimal and in the vast majority of installations there will be no power supply issues.

IMPORTANT: In order for the remote control functions on an LM-2 module to operate, the rear panel **LOCAL/REMOTE** button must be set to REMOTE (button IN). This will disable the front panel **MUSIC SOURCE** and **MUSIC LEVEL** controls, and control of music level and/or source selection will be available from the remote module. The **LOCAL/REMOTE** button should be left set to LOCAL (button OUT) when a BT-1, L-1 or M-1 module is connected to the Facility Port.

The pinout of the Facility Port connector is given in the table below:

PIN	USE	Cat 5 CORE*
1	Audio 'cold' phase (-)	White + Orange
2	Audio 'hot' phase (+)	Orange
3	Priority VCA control	White + Green
4	+ 12 V	Blue
5	0 V	White + Blue
6	-12 V	Green
7	Music level control (0 to 10 V)	White + Brown
8	Music source select control (0 to 10 V)	Brown
SCN	GND ref for system music controls	Connector shell

* Standard wiring for pre-made cables

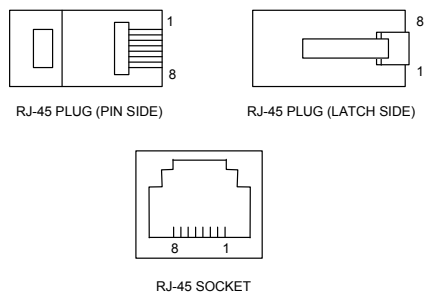

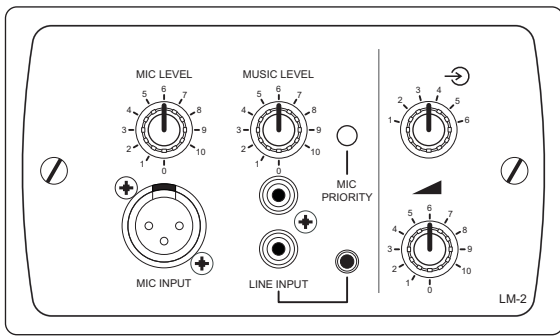

LM-2 mic/line input module, with music source and level controls

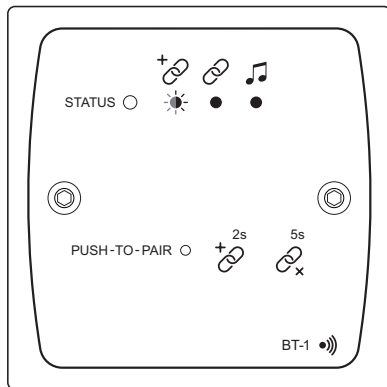

BT-1 Bluetooth wireless audio input module

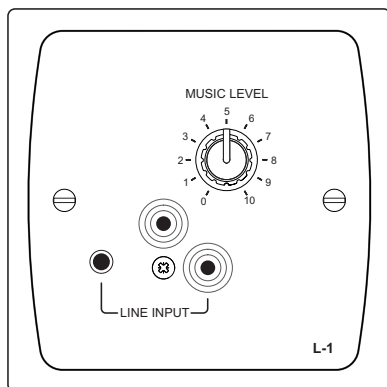

L-1 line input module

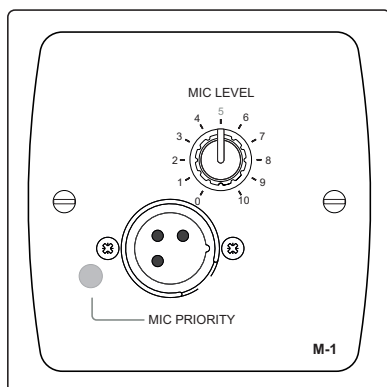

M-1 mic input module

Connecting an active remote module

The LM-2 is an active input module which allows a microphone and a stereo line input in a remote location to be connected to the MPA MK2. The module also includes the functions of a Cloud RSL-6 Remote Control Plate, which allows remote control of the MPA MK2's music level and music source selection.

The BT-1 is a Bluetooth remote audio input module which enables compatible portable devices such as laptops, tablets and smartphones to stream audio wirelessly to the module, and thus into the audio system of the area where the module is installed.

NOTE: The MPA MK2 is only compatible with the BT-1F variant of the BT-1: do not attempt to connect variant BT-1E.

The L-1 and M-1 are remote active input modules which allows a microphone (M-1) or stereo line level source (L-1) to be connected within a zone and then routed to the zone's audio system. The M-1 includes a mic level control and a switchable mic-over-music priority function; the L-1 is fitted with both phono sockets (RCA jacks) and a 3.5 mm 3-pole jack socket, together with a music level control.

The active remote module should be connected to the MPA MK2's **FACILITY PORT** using screened Cat 5 cable. (Note that as the cable carries analogue audio, *only* screened Cat 5 should be used.) The LM-2 includes controls for local music level and source selection, the wiring for these functions being catered for on the Facility Port. The maximum total Cat 5 cable length should not exceed 100 m.

Connections:

LM-2: The LM-2's upper PCB is fitted with an RJ45 connector labelled **OUTPUT**. Connect this to the **FACILITY PORT** using screened Cat 5 cable with screened RJ45 connectors at each end. Follow the colour coding shown in the table on page 19. The metal screening of the connectors should be bonded to the screen of the cable. Full details can be found in the LM-2 Installation Guide.

As explained in the preceding section, before the LM-2's music source and level controls will operate, the **LOCAL/REMOTE** button [22] must be set to **REMOTE**.

BT-1: Connect the RJ45 socket on the rear of the BT-1 to the MPA MK2's **FACILITY PORT** with *screened* Cat 5 cable and shielded RJ45 plugs. Full details can be found in the BT-1 Installation Guide.

M-1 and L-1: Connect the RJ45 socket on the rear of the M-1 or L-1 to the MPA MK2's **FACILITY PORT** with *screened* Cat 5 cable and shielded RJ45 plugs. Full details can be found in the Installation Guide supplied with the module.

The Facility Port may alternatively be used as an additional balanced line input for any other source; see page 22 for details.

Music Mute (Fire Alarm Interface)

In some installations (such as licensed premises or retail outlets within a shopping mall), there may be a local authority or fire service requirement to mute the music signals from a fire alarm control panel when an alarm condition arises. MPA MK2 mixer-amplifiers include a facility to mute the music signals only (i.e., mic inputs are still active), via the **MUSIC MUTE** input. This is a 2-pin 5 mm-pitch screw terminal connector on the rear panel [27], and the contacts are fully isolated.

Activation of Music Mute is often via a relay mounted close to the MPA MK2, powered by the fire alarm control panel. Other arrangements may exist depending on the design of the fire control system and the alarm system details should be consulted when making the connection. MPA MK2 mixer-amplifiers will mute the music on either a contact closure at the Music Mute input (N/O) or an open-circuit (N/C). Selection of N/O or N/C operation is made with internal jumper J11. N/O is the factory default.

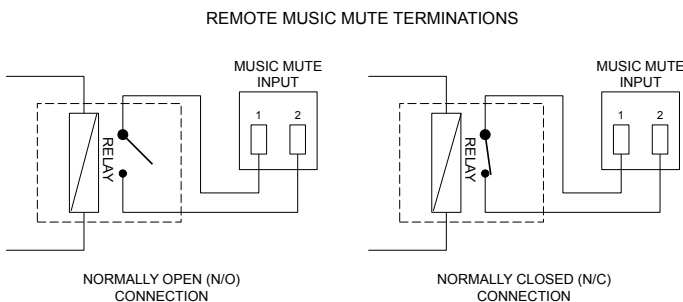

Note that any signal applied to the MPA MK2's Facility Port – either from a remote active module, or as a hard-wired direct input, will be also muted by the action of Music Mute.

When Music Mute is active, the front panel red **MUSIC MUTE** LED [5] illuminates.

Auto Power Down

The MPA MK2 is an extremely energy-efficient mixer-amplifier, but can be made even more so by enabling the Auto Power-Down feature. When active, the signal level is constantly monitored and if no input signals are measured for 15 minutes, the unit enters a "Sleep" mode, minimising power consumption. If an input signal is detected while in Sleep Mode, the mixer-amplifier "wakes up" in approximately one second: if the signal is a line input, the volume will be faded up over a period of three seconds.

The MPA MK2 is shipped with the Auto Power Down function disabled. It may be enabled by removing internal jumper J12. See page 23 for location of PCB jumpers.

Options and Additional Information

Multi-zone Applications

Where the sound system specification calls for separate control in several zones, multiple MPA MK2 mixer-amplifiers can be used.

Signal sources can be parallel-connected to several inputs as required, but care must be taken to ensure the output stage of the signal source is capable of driving the resulting lower input impedance.

The impedance of the line inputs (music inputs) is 47 kohms and it is reasonable to assume that most op-amp based signal sources are able to drive a 10 kohm load, allowing up to five amplifiers to be paralleled. The input impedance of the mic inputs is 3.3 kohms, making them suitable for microphones with a nominal impedance of 600 ohms or less. A single 600 ohm microphone could therefore typically be connected to four paralleled mic inputs.

If these guideline figures cannot be adhered to, the use of suitable mic or line distribution amplifiers is recommended.

To avoid any problems associated with differences in mains supply earthing, we recommend that all MPA MK2 mixer-amplifiers used in a multi-zone application should be co-located and connected to a common mains supply.

Note that when using multiple MPA MK2 mixer-amplifiers in a 19" rack, suitable ventilation arrangements must be made to ensure that lower amplifiers do not cause those above to overheat (see Ventilation on page 13 for further information).

Control of music source and level via external DC

It may be necessary in some installations to adjust the music level and select music source in one or more zones from an external AV control system. If the RSL-6 port is not required for RL-1/RSL-6 Series remote control plates, they may be used to receive DC voltages from the external system to effect these adjustments.

Both music source selection and level can be controlled over their full ranges with a DC voltage of 0 to +10 V. The pinout of the RSL-6 port is as follows:

PIN	USE
1	0 V ref.
2	Music level control (0 to +10 V)
3	Music source selection (0 to +10 V)

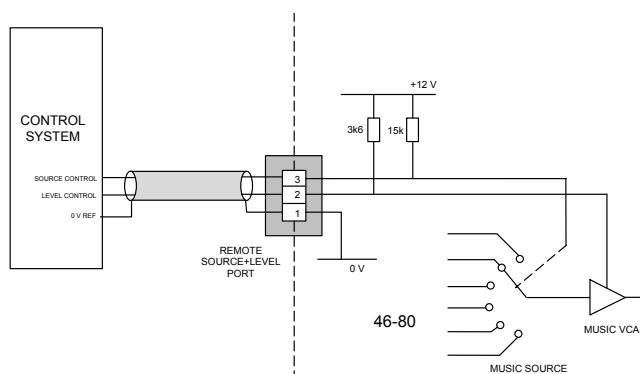

NOTE: If the control voltage source is not isolated from the power earth, there is a small risk of creating a 'ground loop' by linking the mixer technical ground (0 V) to the ground (0 V) of the equipment supplying the control voltages. To minimise this risk, we suggest that all pieces of equipment be in close proximity, and supplied from the same power outlet.

Music level

Music level in a zone may be varied over its full range by applying a DC voltage of between 0 V and +10 V to pin 2, the 0 V reference being connected to Pin 1. 0 V on pin 2 corresponds to maximum level and +10 V will produce 90 dB of attenuation. The rate of attenuation is approximately 175 mV/dB.

Note that there is an internal 3k6 "pull-up" resistor between pin 2 and the internal +12 V rail. If pin 2 is left "floating", this pull-up will result in full attenuation. The output impedance of the control voltage source should be low enough to overcome the effect of this resistor.

Music source

Music source for a zone may be controlled by applying various DC voltages of between 0 and +10 V to pin 3, the 0 V reference being connected to pin 1. 0 V at pin 3 will select Line input 6 and between +6 V and +7.2 V will select Line input 1. The other line inputs will be selected with intermediate voltages. Taking pin 3 above +7.2 V will deselect all inputs, making the zone effectively 'off' for music.

The table below lists the DC voltages required at pin 3 to select each line input. The third column is the value of a resistor which should be connected between pins 1 and 3 to permanently 'force' a zone to a particular line input.

INPUT	DC VOLTAGE	RESISTOR VALUE
OFF	>+7.2 V	Open-circuit
Line 1	+6.3 V	16k
Line 2	+5.1 V	10k
Line 3	+3.9 V	6k8
Line 4	+3.0 V	3k9
Line 5	+1.8 V	1k8
Line 6	0 V	short-circuit

Note that there is an internal 15k "pull-up" resistor between pin 3 and the internal +12 V rail. If pin 3 is left "floating", this

pull-up will cause 'OFF' to be selected. The output impedance of the control voltage source should be low enough to overcome the effect of this resistor.

Using the Facility Port as an auxiliary input

The Facility Port provides a balanced audio input. If the port is not connected to a remote input module or remote control plate, it may be used as an additional, balanced line input. The signal applied at the Facility Port is mixed with the other music inputs and is affected by the rear panel **MUSIC EQ** controls [11]. The Facility Port signal has no independent level control on the amplifier; this must be adjusted at the source. If Mic-over-Music priority is enabled (see "Paging control and mic priority" on page 17), a line input at the Facility Port will be reduced in level by 25 dB in the same way as the other Line Inputs, though this may be overridden by moving internal jumper J8 from its default setting (ON) to OFF. See page 23 for locations of PCB jumpers.

Connect an external balanced source to the Facility Port as shown below:

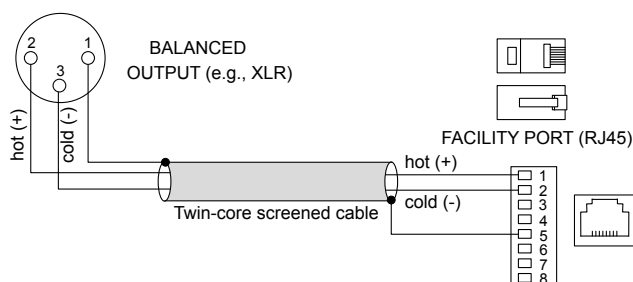

An unbalanced source may also be connected; the use of balancing transformers is recommended.

APPENDIX

PCB jumper locations

The MPA MK2 has various internal jumpers, the setting of which may require alteration during installation. The diagram below shows the locations of the internal jumpers (not to scale), all of which are located on the main PCB. The table below lists each jumper and its purpose, together with the factory default setting.

All "user" jumpers have two possible positions; the black rectangle in the symbol on the diagram below indicates the default setting. If any jumpers need to be changed, turn the MPA MK2 off and disconnect it from the mains. Undo the six screws securing the top cover of the unit and remove it. Use a pair of small pliers to gently remove the jumpers from the PCB headers and reposition them as required. Refit the top cover using the same screws.

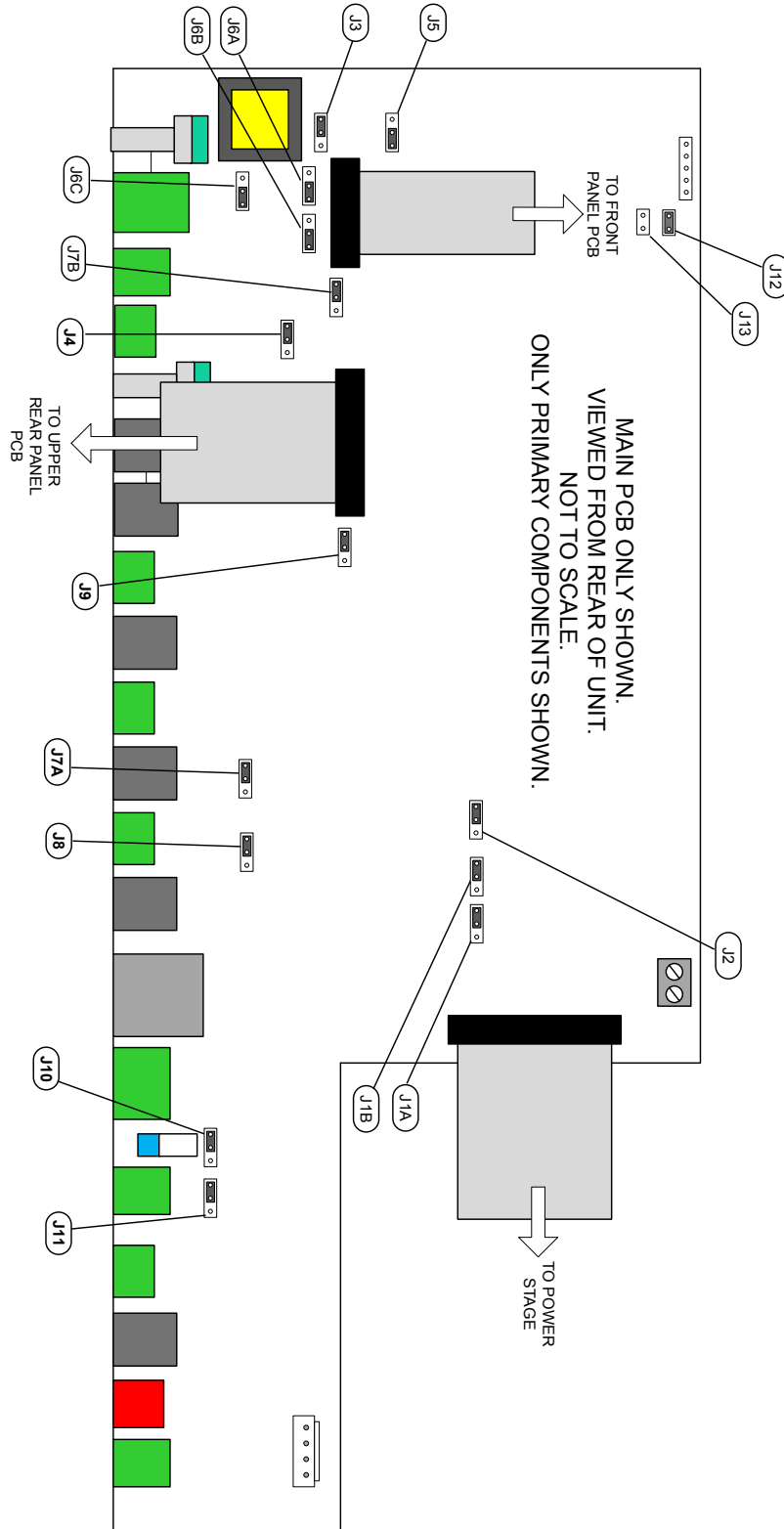

Table of internal jumpers and default settings

The table below lists each jumper and its purpose, together with location and factory default setting.

JUMPER	DESCRIPTION	EFFECT	DEFAULT	REMARKS
J1A, J1B	Line 6 priority	OFF: Line Input 6 operates as other line inputs.	OFF	J1A & J1B must always be moved together.
J2	Line 6 priority release time	3 SEC: selected music source resumes 3 seconds after signal at Line Input 6 ends. 6 SEC: selected music source resumes 6 seconds after signal at Line Input 6 ends. ABSENT: selected music source resumes 12 seconds after signal at Line Input 6 ends.	3 SEC	
J3	Mic Input 1 phantom power	OFF: Mic Input 1 phantom power off. ON: 12 V phantom power available at Mic Input 1.	OFF	
J4	Mic Input 2 phantom power	OFF: Mic Input 2 phantom power off. ON: 12 V phantom power available at Mic Input 2.	OFF	
J5	Page Mic-over Mic 2 priority defeat	OFF: Mic Input 2 will remain active when Mic 1 is in PAGE mode and ACCESS port pins are shorted. ON: Mic Input 2 will be muted when Mic 1 is in PAGE mode and the ACCESS port pins are shorted.	ON	
J6A J6B J6C	Hi-voltage input enable	MIC: Mic Input 1 is a normal balanced mic input. 100V: Mic Input 1 is configured for connection to 70/100 V-line speaker system.	MIC	J6A, J6B & J6C must always be moved together.
J7, J7B	Hi-voltage input internal routing	MIC: Hi-voltage input is routed as Mic Input 1. LINE: Hi-voltage input is routed as Line Input 5.	MIC	J7A & J7B must always be moved together.
J8	Mic-over-Facility port priority	OFF: Mic signals will be mixed at full level with Facility Port input. ON: An input at Mic 1 or Mic 2 will cause a signal from the Facility Port to duck.	ON	
J9	Aux Output music source	TRACK: music source at Auxiliary Output is that selected by MUSIC SOURCE control (or equivalent remote control). LINE1: music source at Auxiliary Output is always Line Input 1	TRACK	
J10	Force front panel music source select	SW: when LOCAL/REMOTE switch is set to REMOTE, front panel MUSIC SOURCE switch is disabled and music source selection is made from remote control plate/module. FR: when REMOTE/LOCAL switch is set to REMOTE, front panel MUSIC SOURCE control remains operative.	SW	
J11	Music mute N/O or N/C	N/O: connect the pins of the MUSIC MUTE connector together to mute Line Inputs 1 to 6 and the Facility Port. N/C: remove a short-circuit across the pins of the MUSIC MUTE connector to mute Line Inputs 1 to 6 and the Facility Port.	N/O	
J12	APD enable	PRESENT: APD (Automatic Power Down) inactive. ABSENT: APD enabled	PRESENT	
J13	APD Test Mode	For factory use only	ABSENT	DO NOT FIT A JUMPER HERE

Troubleshooting

Fault conditions are indicated by the front panel STATUS LED [6] flashing either red or green.

Status LED flashes GREEN - Output Power reduced

If the amplifier temperature exceeds 70°C the output power will be reduced linearly to maintain a safe operating temperature for the internal components. This feature prevents over-temperature shutdown from being triggered and is indicated by a flashing GREEN status LED.

Status LED flashes RED - Over-temperature Shutdown

When the amplifier temperature exceeds 85°C, the unit will mute the speaker and auxiliary outputs: this state is indicated by a flashing RED status LED. Power cycle the unit to clear.

Output power reduction or over-temperature shutdown can occur if the amplifier is incorrectly installed. In this event, investigate the following points:

- Incorrect output setting for connected speaker load.
- Elevated ambient temperature (> 40°C)
- Ventilation requirements not met (no free space above unit)
- Excessive signal input (**PEAK** LED illuminated constantly)

Status LED flashes RED - Amplifier output protection

The MPA MK2 incorporates the following protection schemes to prevent damage to the amplifier or connected speakers:

- Short Circuit protection
- Over-current protection
- DC protection

If any of the three protection schemes is triggered, the unit will mute the speaker and auxiliary outputs and flash the **STATUS LED RED**. The speaker wiring should be checked for faults. A power cycle is required to reset the unit.

EMC Considerations

MPA MK2 mixer-amplifiers fully conform to the relevant electromagnetic compatibility (EMC) standards and are technically well behaved. You should experience no problems interfacing units to other items of equipment and under normal circumstances, no special precautions need to be taken.

If the unit is to be used in close proximity to potential sources of HF disturbance such as high power communication transmitters, radar stations and the like, it is suggested that input signal leads be kept as short as possible.

Always use balanced interconnections wherever possible. If the MPA MK2 mixer- amplifier is mounted in a 19" rack, do not locate the unit in close proximity to a powerful amplifier of any kind, which may radiate a strong magnetic field from the power transformer.

Earthing

When several mains powered units are connected together via their signal cables, there is a risk of one or more earth loops which may cause an audible hum on the system even with the gain controls set to minimum.

The 0 V rail of an MPA MK2 mixer-amplifier is directly coupled to the chassis ground. No interconnection problems should be encountered, but if there is any hum or other extraneous noise when source equipment is connected, the situation can generally be remedied by observing the following guidelines:

- Always connect sources using balanced connections wherever possible, with the cable screen only connected at the receiving end (amplifier input).
- Use audio isolating transformers (readily available from trade suppliers) at the inputs if necessary. These will ensure that the amplifier is electrically isolated from the source equipment.
- The signal source units should be located as close as possible to the amplifiers and the metal housing of the various units should not be electrically connected together through the equipment rack. If this is a problem, rack isolating kits are available from specialist hardware suppliers. If the problem persists, try to connect all interconnected units, including power amplifiers to a common power source to ensure a common ground is provided.

TECHNICAL SPECIFICATIONS

Line Inputs				
Frequency Response	20 Hz to 20 kHz, ± 1 dB			
Sensitivity	195 mV (-12 dBu) to 2.0 V (+8 dBu)			
Input impedance	47 kohms			
Headroom	16 dB			
Noise	<-90 dB (22 kHz bandwidth)			
Equalisation	HF: ± 10 dB @ 10 kHz; LF: ± 10 dB @ 50 Hz			
Microphone Inputs				
Frequency Response	-3 dB @100 Hz (fixed filter) to 20 kHz, ± 1 dB			
Sensitivity	2.54 mV (-50dBu) to 245 mV (-10 dBu)			
Input Impedance	3.3 kohms (balanced)			
Phantom Power	12 V, switchable per-input by jumpers			
Headroom	16 dB			
Noise (EIN)	-126 dBu			
Equalisation	HF: ± 10 dB @ 5 kHz; LF: ± 10 dB @ 100 Hz			
High voltage input				
Frequency Response	via Mic I i/p	-3 dB @100 Hz (fixed filter) to 20 kHz, ± 1 dB		
	Via Line 5 i/p	20 Hz to 20 kHz, ± 1 dB		
Input Gain Control	10 dB to 20 dB			
Noise	<-90 dB (22 kHz bandwidth)			
Facility Input				
Frequency Response	20 Hz to 20 kHz, ± 1 dB			
Sensitivity	0.775 V (0 dBu)			
Input impedance	10 kohms (balanced)			
Headroom	18 dB			
Noise Gate	-60 dB			
Main Output				
Output Power (1 kHz continuous sine wave)	± 0.5 dB, 20 Hz to 20 kHz	120 watts		
	<0.05% @ 1 kHz	240 watts		
Minimum load	Low-Z output	4 ohms		
	High-Z output	70 V-line	MPA120 MK2	41 ohms
			MPA240 MK2	21 ohms
	High-Z output	100 V-line	MPA120 MK2	66 ohms
			MPA240 MK2	33 ohms
Frequency response	Low-Z output	20 Hz to 20 kHz, ± 1 dB		
	High-Z output	20 Hz to 20 kHz, ± 1 dB (65 Hz filter off)		
THD + N	< 0.05% @ 1 kHz			
Protection	Fixed level signal limiter: DC, over-current and over-temperature protection			
Auxiliary Output				
Nominal output level	0 dBu (0.775 Vrms), balanced			
Noise	<-90 dB, 22 kHz bandwidth			

General			
Power input	Universal type, 100 to 240 VAC, 50 to 60 Hz nominal; 85 to 265 VAC, 45 to 65 Hz absolute		
Fuse details	5 x 20 mm, time delay, 4 A		
Normal operating temperature	0 °C to 35 °C (Note: performance and specifications cannot be guaranteed outside of this range)		
Cooling	MPA120 MK2	Natural convection	
	MPA240 MK2	Forced air cooling, variable speed	
Power consumption	Standby ¹	MPA120 MK2	0.89 W (11.8 VA)
		MPA240 MK2	
	Idle ²	MPA120 MK2	9.6 W (18.9 VA)
		MPA240 MK2	
	1/8 th Power ³	MPA120 MK2	29.9 W (40.6 VA)
		MPA240 MK2	48 W (56.7 VA)
	1/3 rd Power ⁴	MPA120 MK2	59 W (67.1 W)
		MPA240 MK2	104.6 W (112.5 VA)
Heat Loss	Standby ¹	MPA120 MK2	3.2 KJ/hr (3.1 BTU/hr)
		MPA240 MK2	
	Idle ²	MPA120 MK2	34.5 KJ/hr (32.8 BTU/hr)
		MPA240 MK2	
	1/8 th Power ³	MPA120 MK2	53.2 KJ/hr (50.5 BTU/hr)
		MPA240 MK2	64.3 KJ/hr (60.9 BTU/hr)
	1/3 rd Power ⁴	MPA120 MK2	68.5 KJ/hr (64.0 BTU/hr)
		MPA240 MK2	87.7 KJ/hr (83.2 BTU/hr)
Dimensions (W x H x D)	Net	482.6 mm x 44 mm (1U) x 150 mm (less connectors & knobs) 19" x 1.75" (1U) x 5.9" (less connectors & knobs)	
	Shipping (Gross)	560 mm x 60 mm x 290 mm 22" x 2.4" x 11.4"	
Weights	Net	2.15 kg / 4.8 lbs	
	Shipping (Gross)	3.2 kg / 7.2 lbs	

Notes re Power Consumption and Heat Loss measurements:
All measurements at 230 VAC 50 Hz power input

1. Standby: amplifier in standby state (STATUS LED steady red)
2. Idle: amplifier not in standby state (STATUS LED steady green), but no audio output
3. 1/8th. Power: constant sound level at one-eighth maximum rated output (audio mainly clean, only occasional clipping)
4. 1/3rd. Power: constant sound level at one-third maximum rated output (audio beginning to become compressed, limited or heavily clipped)

www.cloud.co.uk



www.cloudusa.pro

MADE IN BRITAIN 