

DIGITALLY CONTROLLED ZONE MIXERS

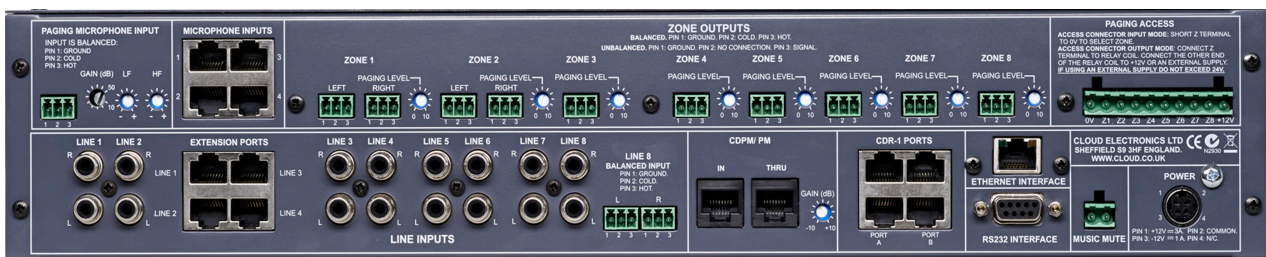

DCM1 - Front View



DCM1e - Rear View

General Description

The Cloud DCM1 and DCM1e are analogue multi-zone audio mixers. A digital control system, using a front-panel LCD display and a simple, minimal set of controls replace the relatively large number of switch and rotary controls found on conventional units, yet provide far greater flexibility of configuration than would be possible with such units. The mixers provide a simple, reliable and elegant method of providing audio to multiple zones in retail outlets, bars, hotels, schools, conference centres, offices, factories and other types of premises. Once configured, the mixers allow zones to be combined or separated as space utilisation of the building demands.

The mixers allow connection of eight line level sources, and provide eight zone outputs, two of which are stereo. Any source can be routed to any zone, and the music level in each zone can be adjusted independently. A wide range of configuration options is available to the installer to optimise the system to the premises and the client's requirements, such as restricting source selection in some zones or defining minimum and maximum volume levels.

A range of optional remote plates is available to permit music control in any or all zones and external inputs from mic and line sources. (See separate datasheets for Cloud accessories CDR-1, LE-1, BE-1, ME-1.) While the DCM1 and DCM1e are also directly compatible with the Cloud PM range of paging microphones, most third-party paging systems are easily integrated. In common with all Cloud installed audio products, a Music Mute input is provided to aid compliance with local Fire Regulations.

The DCM1 has been designed to be completely self-contained, and can be fully configured and controlled without a computer of any kind. However, a software Configuration Tool is available (a free download) to enable configuration from a computer if this method is preferred.

The DCM1e greatly extends the DCM1's functionality by adding an Ethernet interface and an internal web server, allowing control from a smartphone, laptop, tablet device or computer via a web browser.

DCM1 & DCM1e Accessories (examples)

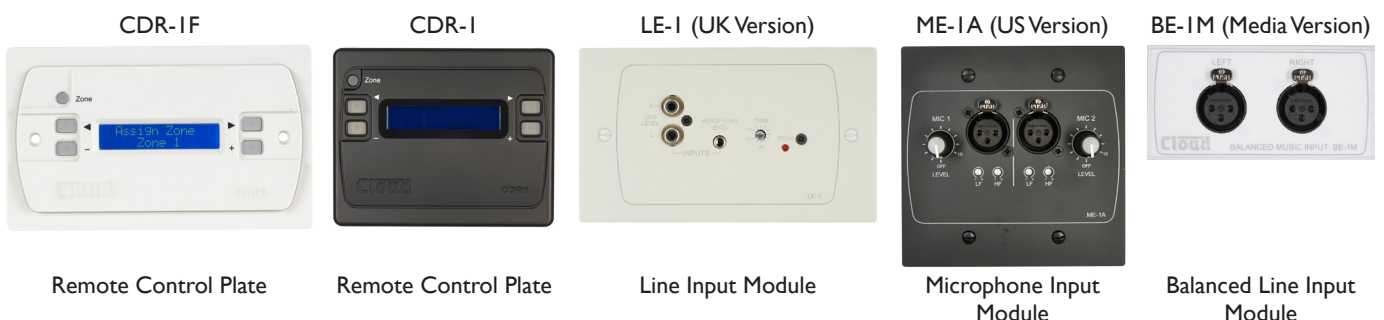

DCM1e Control Using Web Browser (sample menus when used with a smartphone)

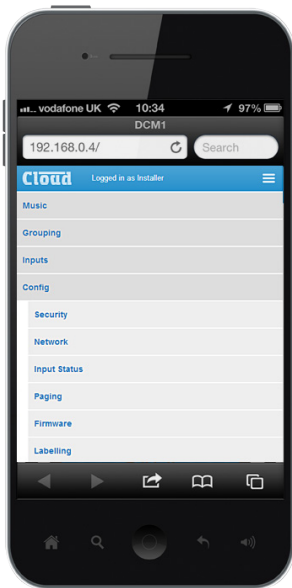

Configuration Menu

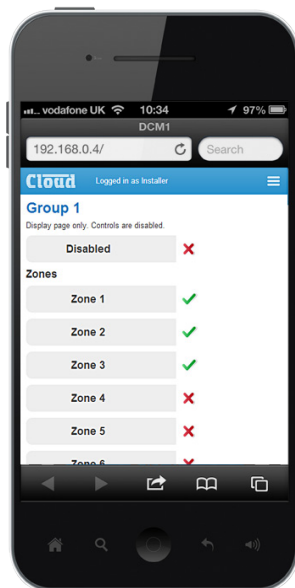

Group Assignment Menu

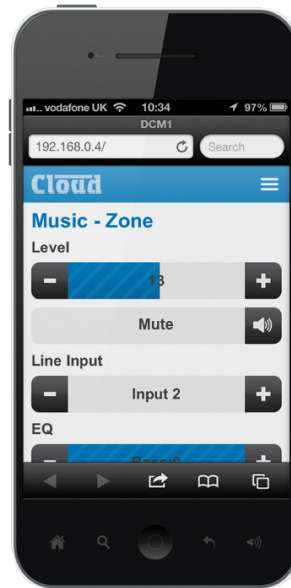

Music Controls per Zone

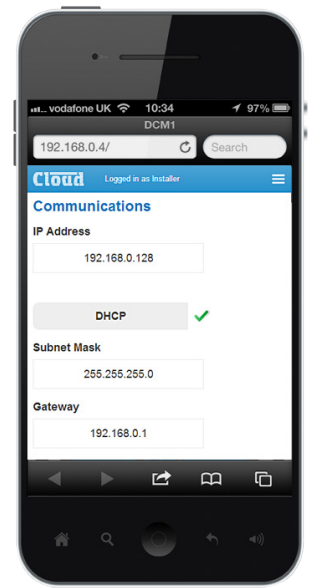

Network Setup Menu

Further Examples Showing Complete Menus

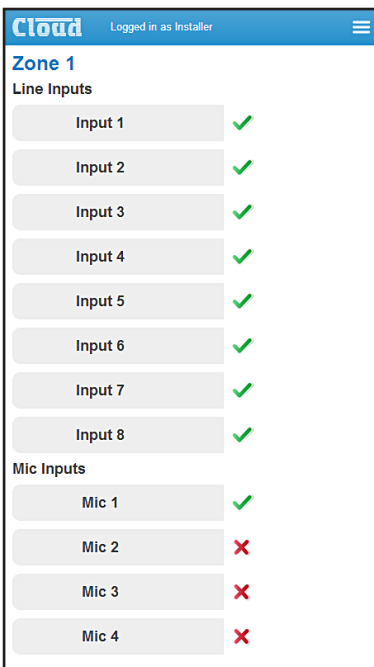

Input Selection Per Zone

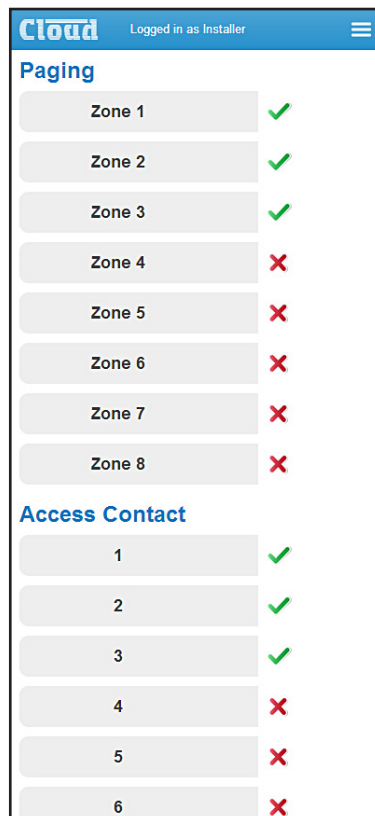

Paging Assignment

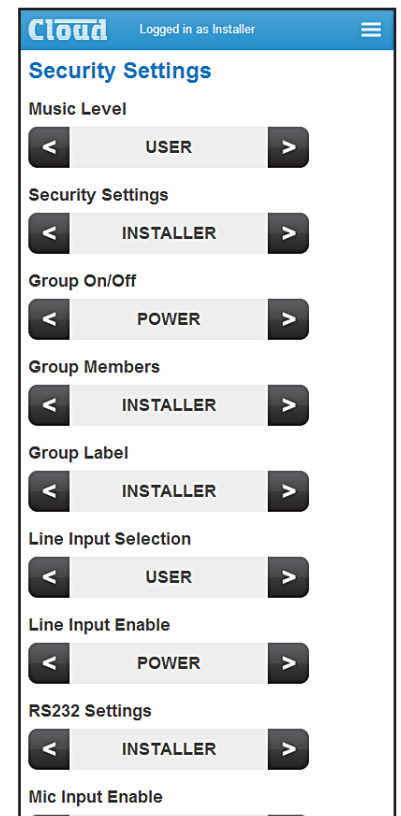

Security Settings

Key Features

- 8 stereo line inputs (1 balanced), with input level trims (via menu system)
- 8 balanced line outputs (2 stereo + 6 mono)
- Any source may be routed to any zone at any level
- 4 Extension Ports for optional remote line input modules (balanced or unbalanced), using Cat 5 UTP cable
- 4 Mic Inputs for optional remote mic input modules, using Cat 5 UTP cable
- External inputs (mic or line) may be routed to any zone
- RJ45 interface for Cloud PM Series digital paging microphones
- Separate analogue paging mic input with standard short-to-ground zone selection
- Paging to all zones with fully programmable override logic
- Supports up to 100 CDR-I Remote Controls (optional), in any wiring configuration, using Cat 5 UTP cable
- Remote control of source, level, EQ and group enable via CDR-I plates
- 2 x 16 character LCD dot-matrix display (both DCM1/DCM1e and CDR-I)
- Four definable zone groups; groups have same selection options as zones
- Any line input may have priority in any zone; configurable per-zone
- Configurable source selection restriction, per-zone
- Key-protected "Installer" mode (both DCM1/DCM1e and CDR-I) prevents user access to configuration menus
- Inputs, zones and groups can be named

- RS232 interface for control by third-party control systems
- Paging access port may be reconfigured as eight GPIO ports, under RS-232 or Ethernet (DCM1e only) control
- Front-panel LEDs confirm remote access
- Optional per-zone EQ cards to suit a range of popular installation loudspeakers
- Software Configuration Tool available (free download) to permit easy configuration from a computer
- Self-contained - can be fully configured and controlled without a computer if preferred
- Multiple mixers may be cascaded to create larger systems
- External Music Mute input for interfacing with emergency systems
- Any input (mic or line) may be assigned as Emergency Input, overriding Music Mute
- 2U 19" rack-mounting unit

DCM1e only – Additional features

- Ethernet port with internal web server
- Control over main user functions from web-capable devices
- Extended range of password-protected functions
- Ethernet to RS232 bridge may be used to send commands to third-party equipment

System Example - Hotel/Large Restaurant (DCM1)

The system shown could typically be a hotel or large restaurant, and illustrate how some of the DCM1's many features may be used in practice:

- The large area has two CDR-I remote controls in the same zone; typically, these might be adjacent to doors at opposite ends of the room.
- Two of the areas are separated by a folding partition which may be removed to create one large space. By assigning these two zones to a Group within the DCM1, the two zones can be treated as one for audio purposes when the partition is removed and return to two separate zones when it is reinstated.
- Each half of the partitioned area also has an ME-I mic input plate. Because these have been wired back to the DCM1 independently, each can be made available to their respective room halves as and when required. Alternatively, it may be that they are only required when the partition is folded back; in this case they are activated for the Group instead.

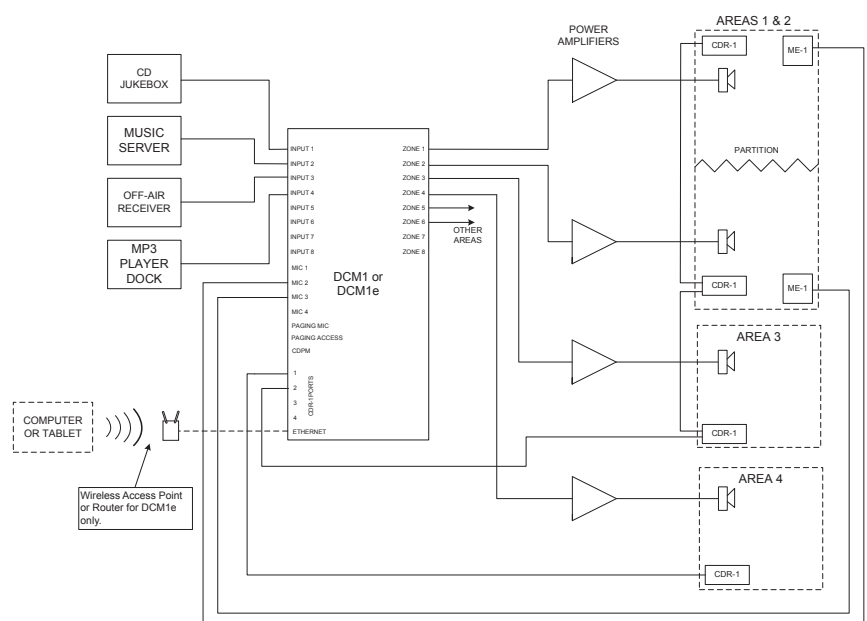

- If the model of mixer is a DCM1e, system control is available to the user via a web browser on an Internet-capable device. Browser control can be configured at installation so that only the operational features required by the venue staff are accessible to them; all other functions are password-protected.

Block Diagram

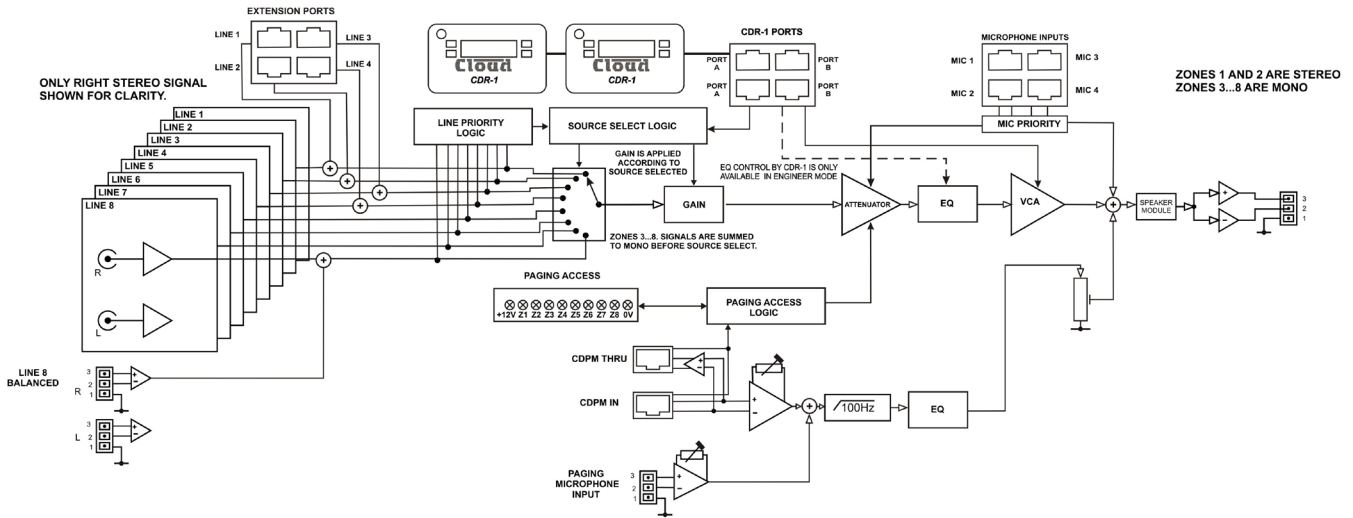

Technical Specifications

Line Inputs

Frequency Response	20 Hz - 20k Hz ± 1 dB
Distortion	<0.05 %, 20 Hz - 20k Hz
Sensitivity	195 mV (-12 dBu) to 3.1 V (+12 dBu)
Input Gain Control	24 dB range
Input Impedance	47k Ω
Headroom	>+10 dB
Noise	-90 dB A weighted (0 dB gain)
Equalisation	HF: ± 14 dB/10k Hz MID: ± 14 dB/1200 Hz LF: ± 14 dB/50 Hz

Paging Microphone Inputs

Frequency Response	100 Hz / -3 dB(filter) to 20 kHz ± 0.5 dB
Distortion	<0.05% 20 Hz-20k Hz
Gain Range	10 dB - 50 dB
Input Impedance	>2k Ω (balanced)
Phantom Power	+12 V (PCB jumper for on/off)
Headroom	>20 dB
Noise	-120 dB EIN 22 Hz - 22k Hz (150 Ω)
Equalisation	HF: ± 10 dB/5k Hz LF: ± 10 dB/100 Hz

Outputs

Balanced Zone Outputs	775 mV (0 dBu)
Minimum load impedance	600 Ω
Maximum output level	+10 dBu (2.6 V)

External Power Supply

External Supply Input	100 V-240 V AC; 47-63 Hz; 1.35 A
Power supply	+12 V, 3 A; -12 V 1 A

Physical

Dimensions (w x h x d)	482.6 mm x 88 mm (2U) x 170 mm 19" x 3 1/2" 6 3/5"
Dimensions (packed)	570 mm x 270 mm x 220 mm 22" x 11" x 9"
Weight	3.12 kg (7 lbs) net 4 kg (8.8 lbs) packed

Graphs

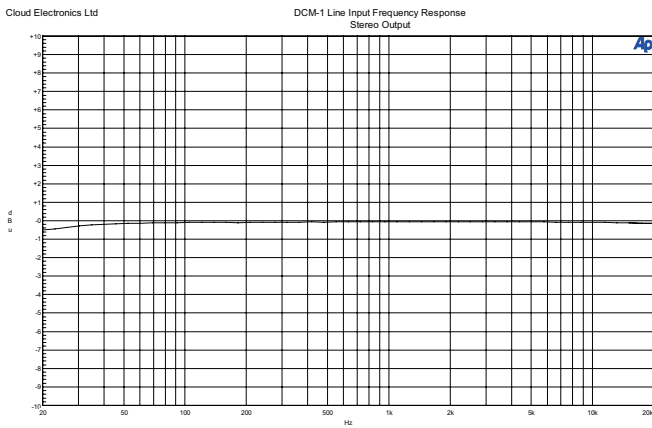

DCM1/DCM1e Line Input Frequency Response Stereo Output

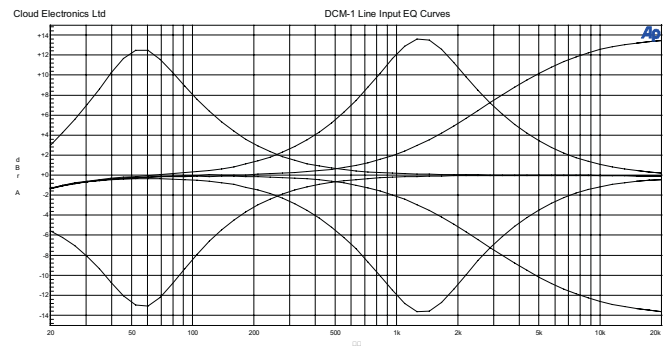

DCM1/DCM1e Line Input EQ Curves

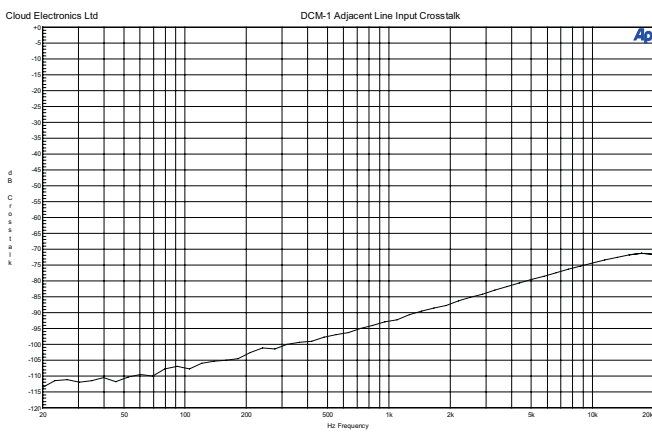

DCM1/DCM1e Adjacent Line Input Crosstalk

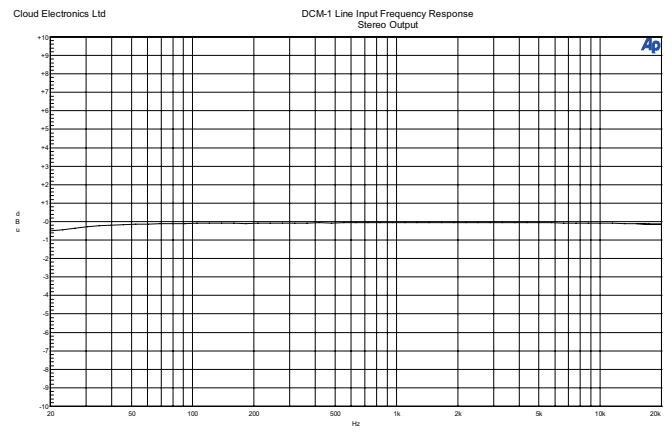

DCM1/DCM1e Line Input Frequency Response Stereo Output

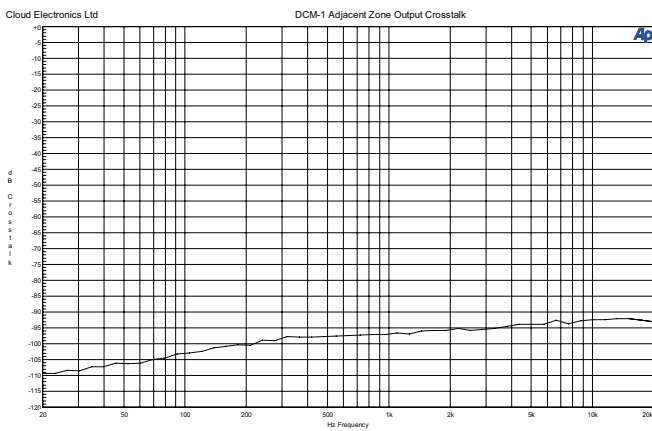

DCM1/DCM1e Adjacent Line Input Crosstalk

Architect's and Engineer's Specification

The Zone Mixer's audio signal paths shall be fully analogue in design; there shall be a simple menu/display system on the front panel for accessing all system controls and configuration options. It shall be possible to access all control functions without the use of any external computers or software. A PC-compatible software application shall be available; this shall interface with the Zone Mixer via an RS232 connection and shall provide an alternative method of accessing all control and configuration options.

Two versions of the Zone Mixer shall be available; these shall be identical in terms of their audio functions. One shall include an standard RJ45 Ethernet interface and internal web server; on this version it shall be possible to access main control functions from a standard web browser on devices connected to the same network as the Zone Mixer.

The Zone Mixer shall have 8 stereo line channels, 4 microphone inputs and a paging mic input. Line inputs shall be on RCA jacks; one shall also be available as a balanced input on Euroblock connectors; four shall also have RJ45 sockets providing balanced inputs for the connection of optional balanced or unbalanced stereo external connection modules. The microphone inputs shall be balanced on RJ45 sockets for connection of optional external modules. The Line Inputs shall each have level trim adjustment available via the menu system. The remote modules shall be available in a range of sizes and finishes.

The Zone outputs shall be balanced on Euroblock connectors. At least two shall be stereo, the remainder mono. It shall be possible to adjust the following parameters for each Zone output: Level, Maximum and Minimum Levels; EQ (3-bands). It shall be possible to route any microphone or line input to any Zone output without restriction, and to adjust each Zone output level independently. It also shall be possible to make one or more line Inputs unavailable to any Zone without restriction. It shall also be possible to define up to 4 Groups of Zones; enabling/disabling Groups shall be possible without entering a password. It shall be possible to assign alphanumeric names to all Inputs, Zones and Groups; these will still apply after any hardware reset operation.

An optional remote control plate with the same display as the host unit shall be available for the Zone Mixer. The plate shall be provided with IN and OUT sockets to permit series interconnection of up to 100 plates. It shall be possible to configure a plate to provide the following control functions for its assigned Zone: for immediate access - Line Input Select and Music Level; with password entry - Zone EQ (3 bands). The plates shall be available in a range of styles and finishes.

The Zone Mixer shall interface directly with Cloud PM Series paging microphones and/or third-party paging microphones employing short-to-ground zone access. The input for a third-party Paging Mic shall be dedicated, and on a Euroblock connector; routing this to any/all Zones will be by contact closure at a separate Euroblock connector. Both Paging Mic inputs shall have rear panel gain controls; HF and LF EQ controls shall also be provided, effective on both inputs.

The Zone Mixer shall have a rear panel paging level adjustment for each Zone. The music signal in a Zone shall reduce in volume when that Zone is being paged, and the Hold Time, Release Time and Music Attenuation shall all be adjustable. It shall also be possible to trigger music level reduction by Zone Selection or Paging Mic signal presence. It shall be possible to assign per-Zone Priority status to any line or microphone input, such that a Priority signal above a fixed threshold overrides the current Input selection in each Zone for as long as the Priority signal remains above the threshold. In connection with this, the following parameters shall be adjustable: Hold Time, Release Time; Music Attenuation (Mic Priority only).

There shall be a Music Mute Input; this will cause muting of the music in all Zones. Muting control shall be configurable on either external contact closure (N/O) or short-circuit removal (N/C). It shall also be possible to assign any one line or microphone Input to remain unmuted during Music Mute operation for Emergency system interface.

The front panel shall provide the following features: power switch, backlit LCD display, rotary encoder with "press" function and software-assignable push-buttons for control functions. One of the buttons shall control the Zone Mixer's menu system. Five further buttons shall select submenus, and another button shall activate a set of menu options which require the entry of a password. The password shall be redefinable by the User. The front panel shall also include various LEDs indicating: external paging access, remote line input selection, remote mic input selection and emergency Music Mute activity.

It shall be possible to save all current settings and reload these settings when power is applied. Alternative power-up options shall be to load the original factory settings or those in force at power-down, even if they were not specifically saved.

The Zone Mixer shall include an RS232 serial port permitting remote control of all unit functions and settings. The Ethernet-enabled version of the Zone Mixer shall also have the ability to relay serial data from the Ethernet port to the serial port; it shall also be possible to redefine the function of the Paging Access connector to provide open-collector pull-down outputs becoming active under commands received at the RS232 or Ethernet ports.

It shall be possible to retro-fit optional loudspeaker equaliser cards to any or all Zone outputs. Cards shall be available to optimise the outputs for use with various popular installation loudspeakers.

The Zoner shall be built in a steel chassis for mounting in a standard 19" rack enclosure.

The Zone Mixer shall be the Cloud DCMI; the Ethernet-enabled version shall be the Cloud DCMIe. The remote control plates shall be the Cloud CDR-I Series; the remote input plates the Cloud LE-I Series (unbalanced line), Cloud BE-I Series (balanced line) and Cloud ME-I Series (microphone).

Cloud Electronics Limited

140 Staniforth Road, Sheffield, S9 3HF. England.
Telephone: +44 (0)114 244 7051 Fax: +44 (0)114 242 5462
Web: www.cloud.co.uk E-mail: info@cloud.co.uk

Cloud Electronics USA

2065 Sidewinder Drive, Suite 200, Park City,
Utah 84060. United States of America.
Toll Free: 0855 810 0161
Web: www.cloudusa.pro E-mail: sales@cloudusa.pro