



CX462 AUDIO SYSTEM CONTROLLER

Cloud Electronics Limited

CX462 Installation & Setup Guide

CLOUD ELECTRONICS LIMITED

CX462 Installation and Setup Guide

© Cloud Electronics Limited
140 Staniforth Road • Sheffield S9 3HF • England
Phone +44 (0)114 244 7051 • Fax +44 (0)114 242 5462
E-mail technical@cloud.co.uk • WebSite www.cloud.co.uk

Table of Contents

Section	Page
1 Safety Notes	1
2 General Description	1
3 Schematic Diagram	2
4 Installation	2
5 Stereo/Music Inputs	2
5.1 Sensitivity and Gain Control	2
5.2 Music control - Local or Remote	3
5.3 Music Equalisation	4
5.4 Line 6 Priority	4
6 Microphone Inputs	5
6.1 Microphone Access Contacts	6
6.2 Microphone Gain Controls	6
6.3 Microphone Level Controls	7
6.4 Microphone Equalisation	7
6.5 High Pass Filter	7
6.6 Microphone 1 Priority	8
6.7 Microphone over Music priority	8
7 Output Details	9
8 Active Modules - General Specification	9
8.1 Active Equalisation Modules	10
8.2 Cloud CDI-S100 Serial Interface Module	11
9 Remote Music Mute - Fire Alarm interface	12
10 Technical Specifications	12
11 General Specifications	13

Table of Contents

Section	Page
12 Troubleshooting	13
12.1 Ground/Earth Loops	13
12.2 Connecting balanced signals to unbalanced line inputs	13
12.3 Cloud CDI-S100 Serial interface is not working properly	14
12.4 Microphone access switches not working correctly	15

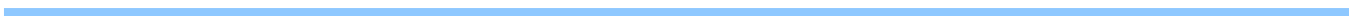

1 Safety Notes

For more detailed information refer to the rear of the manual.

- ◆ **Do not expose the unit to water or moisture.**
- ◆ **Do not expose the unit to naked flames.**
- ◆ **Do not block or restrict any air vent.**
- ◆ **Do not operate the unit in ambient temperatures above 35°C.**
- ◆ **Do not touch any part or terminal carrying the hazardous live symbol (⚡) while power is supplied to the unit.**
- ◆ **Do not perform any internal adjustments unless you are qualified to do so and fully understand the hazards associated with mains operated equipment.**
- ◆ **The unit has no user serviceable parts. Refer any servicing to qualified service personnel.**
- ◆ **If the moulded plug is cut off the lead for any reason, the discarded plug is a potential hazard and should be disposed of in a responsible manner.**

2 General Description

The Cloud CX462 is a versatile, microphone and line input mixer. The mixer has a music section with six stereo line inputs. A source select control routes the desired line input to the stereo music outputs. It has a microphone section with four microphone inputs that are mixed and sent to the separate, mono mic output. In order to increase the mixers versatility there are controls to add the output of one section to the other. There are various optional accessories that extend the flexibility of the CX462:

- ◆ **Optional serial interface card (CDI-S100) that allows control of:**
 - ◆ **Music level and source**
 - ◆ **Master microphone level**
 - ◆ **Individual microphone mutes**
- ◆ **Optional remote plates that allow control of**
 - ◆ **Music level and source. RSL-6**
 - ◆ **Master microphone level RL-1**
- ◆ **Equalisation Modules for Bose® Model 8, 25, 32 & 102 Speakers.**

Along with these accessories the CX462 has: - Microphone priorities, Fire alarm mute and the possibility for Line 6 to have priority over other music signals.

Controls for the CX462 are provided on either the front or the rear of the product. Controls which should only be configured when the product is being installed are located on the rear panel; controls used to change the level, music source, tone or prioritisation in the CX462 are located on the front panel. Once the tamperproof facia is in place, only the level, source selection and power controls will be available.

3 Schematic Diagram

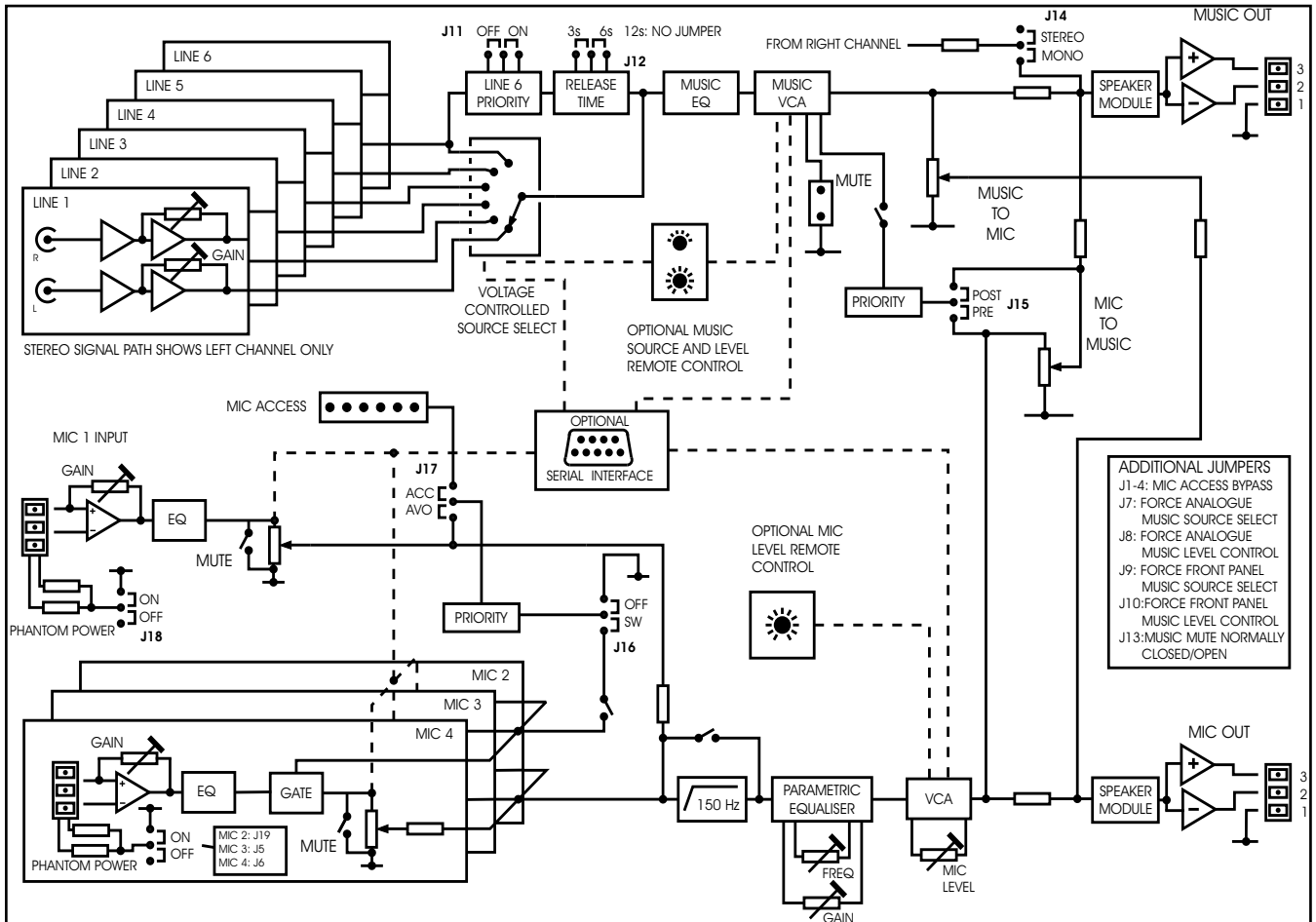

4 Installation

The Cloud CX462 occupies one unit of standard 19" equipment rack. Front panel pre-set controls can be covered with the cover provided. Ventilation holes on the base of the unit should not be obscured. The CX462 is 152.5mm deep but a depth of 200mm should be allowed to clear connectors.

5 Stereo/Music Inputs

The music section of the CX462 has six stereo inputs. These line inputs are suitable for most music sources such as compact disc players, tape players and receivers etc.. All inputs are unbalanced and use RCA type phono connectors. Input impedance is 48kΩ.

5.1 Sensitivity and Gain Control

All six line inputs have pre-set gain controls which are accessible on the rear panel, adjacent to their respective input sockets. The input sensitivity can be varied from -17.6dBu (100mV) to + 5.7dBu (1.5V). The pre-set gain controls should be set so that all the input signals operate at the same level within the CX462 and the music level controls have an optimum control range.

5.2 Music control - Local or Remote

The music source and music level control functions can be controlled from either the front panel or a remote control plate located up to 100m from the CX462. There are two remote control plates available for the CX462, the RSL-6 and the RL-1. The RSL-6 should be used when remote control of music source and music level is required whereas the RL-1 can be used when the application calls for remote control of the level only (source selection via front panel). RSL-6 and RL-1 remote control plates can be mounted onto a standard British flush or surface mounted 25mm deep back box. Two-core cable with overall screen should be used to connect the remote controls to the Cloud CX462 and the diagrams below show how to connect the two remote plates. Self-adhesive labels (supplied) can be affixed to the front panel and/or RSL-6 to identify the available input sources.

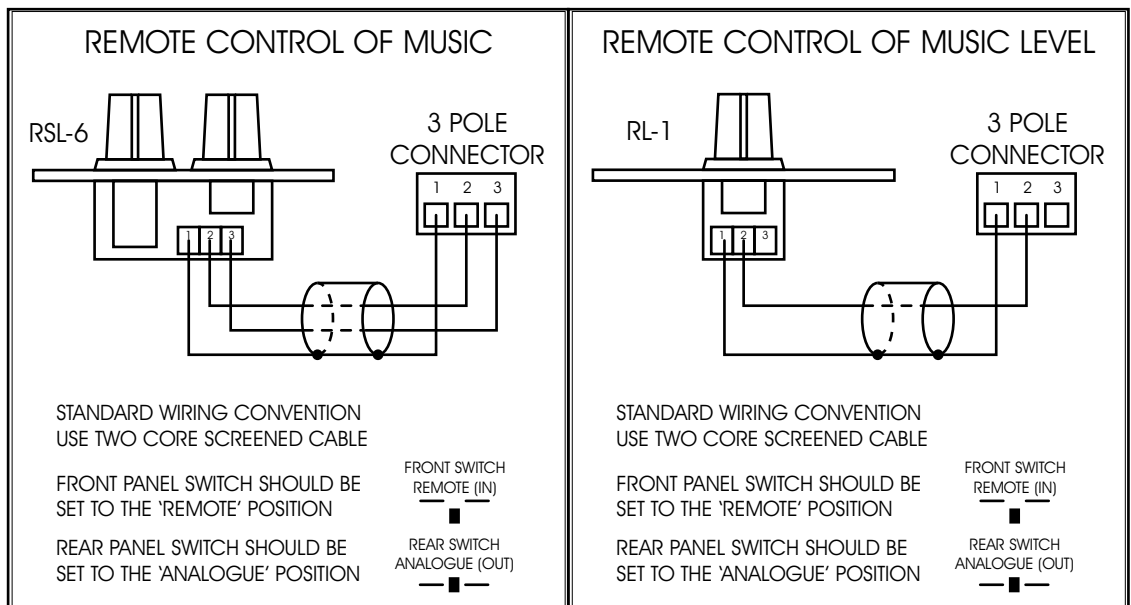

For remote operation of music level (RL-1) or level and source select (RSL-6), the front panel switch must be set to the 'REMOTE' position. The rear panel switch marked 'REMOTE TYPE' should be set to the 'ANALOGUE' position. Jumpers J7-J10 determine whether the control of the music controls is determined by the rear panel switch. A table containing the possible configurations and their effects is detailed below.

FRONT/SWITCH		AN/SW		FRONT SWITCH	REAR SWITCH	LEVEL	SOURCE SELECT
J9	J10	J7	J8				
N/A	N/A	N/A	N/A	'LOCAL'	N/A	FRONT	FRONT
'FR'	'FR'	N/A	N/A	N/A	N/A	FRONT	FRONT
'SW'	'SW'	'SW'	'SW'	'REMOTE'	'ANALOGUE'	RSL-6	RSL-6
'SW'	'SW'	'SW'	'SW'	'REMOTE'	'DIGITAL'	CDI-S100	CDI-S100
'SW'	'FR'	'SW'	N/A	'REMOTE'	'ANALOGUE'	FRONT	RSL-6
'SW'	'FR'	'SW'	N/A	'REMOTE'	'DIGITAL'	FRONT	CDI-S100
'FR'	'SW'	N/A	'SW'	'REMOTE'	'ANALOGUE'	RSL-6/RL-1	FRONT
'FR'	'SW'	N/A	'SW'	'REMOTE'	'DIGITAL'	CDI-S100	FRONT
'SW'	'SW'	N/A	N/A	'REMOTE'	'ANALOGUE'	RSL-6	RSL-6
'SW'	'SW'	'AN'	'AN'	'REMOTE'	N/A	RSL-6	RSL-6
'SW'	'SW'	'AN'	'SW'	'REMOTE'	'DIGITAL'	CDI-S100	RSL-6
'SW'	'SW'	'SW'	'AN'	'REMOTE'	'DIGITAL'	RSL-6/RL-1	CDI-S100

Music Control continued

Remote control enabling jumpers

J9: Music source
J10: Music level

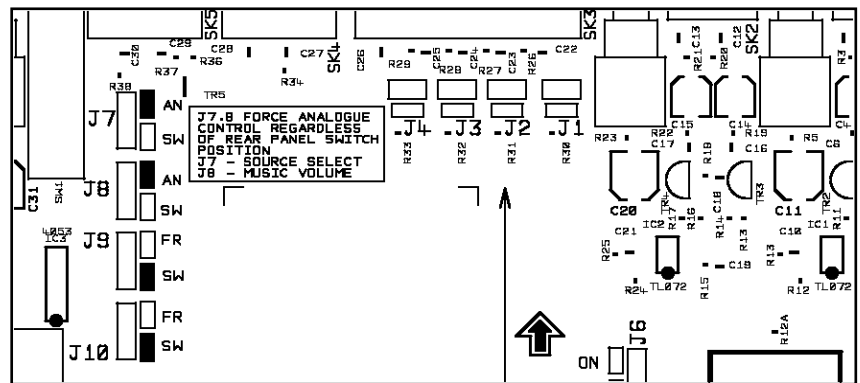

Location of Jumpers J9 & J10

The RSL-6A and RL-1A are available for the American market. They have identical operation to the RSL-6 and RL-1 but have been designed to fit a single gang US electrical outlet box. Front panel dimensions are 4½" x 2¾".

When setting the jumper(s) please ensure that you:

- ♦ Remove the mains cable from the rear of the product before removing the top panel.
- ♦ Only reassemble the unit using screws identical to the original parts.

5.3 Music Equalisation

Front panel pre-set controls for treble and bass equalisation of the music signals are provided in order to allow the installer to tailor the response of the music signals to suit the acoustics and speaker's response. The equalisation controls can be concealed behind the removable plate secured to the front panel with hex key screws; to gain access to the equalisation controls use the supplied hex key. The equalisation controls are located to the left of the music source and level controls; they are clearly marked 'HF' (High Frequency) and 'LF' (Low Frequency). A flat frequency response can be achieved by positioning the slots on the control shafts in the vertical plane; the HF control has a range of ±10dB at 10kHz and the LF control has a range of ±10dB at 50Hz.

5.4 Line 6 Priority

The line 6 music input can be given priority over other music signals. This is intended for use with sources such as jukeboxes or spot announcement players. This priority is triggered when a signal is detected on the line 6 input, at which point the selected music source will mute and the line 6 signal is routed to the output. Once the signal on line 6 ceases, the selected music source will smoothly restore to its former level. The time taken for this restoration can be 3, 6 or 12 seconds dependant on how internal jumper J12 has been set; the factory default restoration time is 3 seconds. In order to switch priority on or off, the internal jumper J11 can be set, both jumpers a and b will need to be set in the same position.

When setting the jumper(s) please ensure that you:

- ♦ Remove the mains cable from the rear of the product before removing the top panel.
- ♦ Only reassemble the unit using screws identical to the original parts.

Line 6 Priority continued

Line 6 Priority Jumpers

- J11: Priority on/off**
- J12: Release time** **3s**
- 6s**
- 12s**

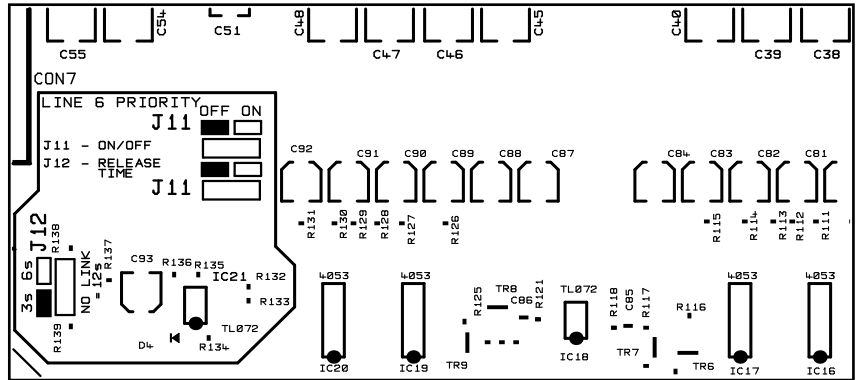

Location of Jumpers J11 & J12

6 Microphone Inputs

Four microphone inputs are provided each having electronically balanced, transformer-less circuitry configured for optimum low noise performance. The input impedance is greater than 2kΩ and suitable for microphones in the 200Ω to 600Ω range. Inputs are via 3-pin plug in screw terminal type connectors (Phoenix type) located on the rear panel. A facility to provide 15V phantom power is included for each microphone that is activated by setting the relevant internal jumpers from the list below to the 'ON' position:

- J18: Mic 1 phantom power**
- J19: Mic 2 phantom power**
- J5: Mic 3 phantom power**
- J6: Mic 4 phantom power**

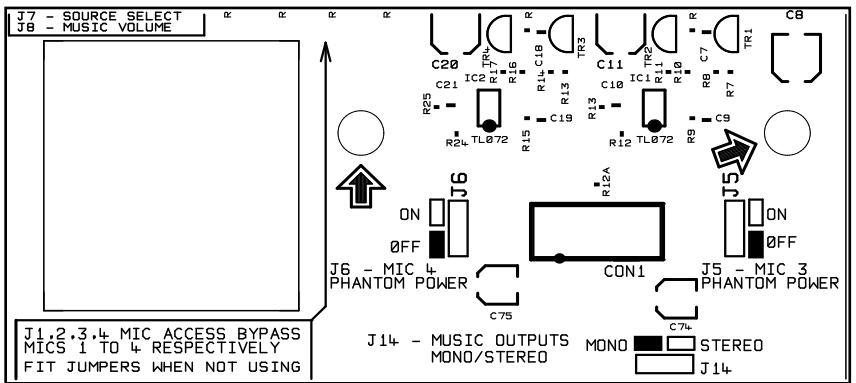

Location of Jumpers J5 & J6

NOTE: Microphones one and two have their jumpers located on the upper microphone input circuit board.

When setting the jumper(s) please ensure that you:

- ◆ Remove the mains cable from the rear of the product before removing the top panel.
- ◆ Only reassemble the unit using screws identical to the original parts.

All microphone inputs are balanced with the following pin configuration:

- ◆ Pin 1 - GROUND
- ◆ Pin 2 - COLD/INVERTING
- ◆ Pin 3 - HOT/NON-INVERTING

To connect an unbalanced microphone to the input, use pins 1 and 3 with pin 2 connected to ground (Pin 1).

6.1 Microphone Access Contacts

Access contacts for each individual microphone input are provided on the rear panel. Individual microphone inputs can be activated by connecting their respective contact to the 0V contact, leaving the access terminal open circuit will mute the microphone input. This provides the facility to mute microphones using remote switches. When these access contacts are not required they can be bypassed via the configuration of the internal jumpers detailed below:

Access bypass jumpers

J1- 4: Microphones 1- 4 respectively

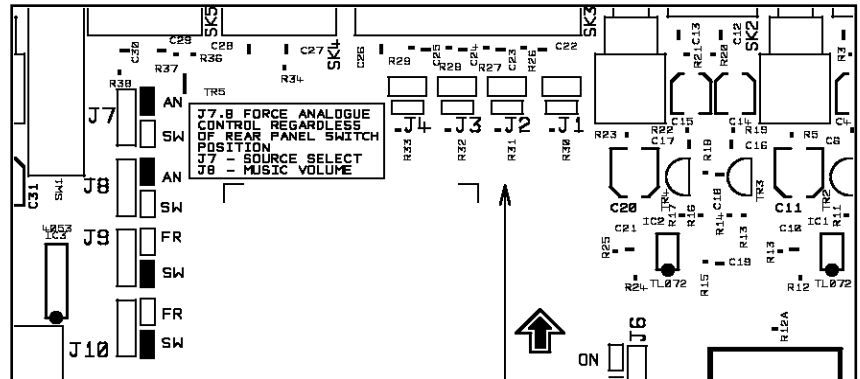

Location of Jumpers J1- 4

NOTE: We advise that when you remove a jumper you leave it connected to one pin of the header so it remains with the apparatus for future use.

The default factory configuration of these jumpers is to bypass access terminals, leaving all microphone inputs active. It is also possible to mute the microphone inputs using the CDI-S100 interface module. In order for the CDI-S100 to effectively mute a microphone channel, the corresponding jumper must be in place.

When setting the jumper(s) please ensure that you:

- ◆ Remove the mains cable from the rear of the product before removing the top panel.
- ◆ Only reassemble the unit using screws identical to the original parts.

6.2 Microphone Gain Controls

Pre-set gain controls are provided adjacent to the respective microphone input. The gain can be adjusted from 0dB to 60dB. Typically, a setting of ~30dB is adequate for dynamic microphones. A high overload margin is maintained at all gain settings. This should allow a signal range from 0.775mV (-60dBu) to 775mV (0dBu).

6.3 Microphone Level Controls

Each microphone has separate front panel mounted controls for their respective level. Rotating any microphone level control fully anti-clockwise effectively turns the microphone off. In addition microphones can be muted via the access contacts on the rear panel (see section 6.1)

Master microphone level can be controlled locally via the front panel rotary control, or through a remote wall plate up to 100m away from the unit. To configure the CX462 for remote level operation, the front panel switch must be in the 'REMOTE' position. The rear panel switch marked 'REMOTE TYPE' should be in the 'ANALOGUE' position. Master microphone level can also be controlled via the Cloud CDI-S100 Serial Interface Module (see section 8.2).

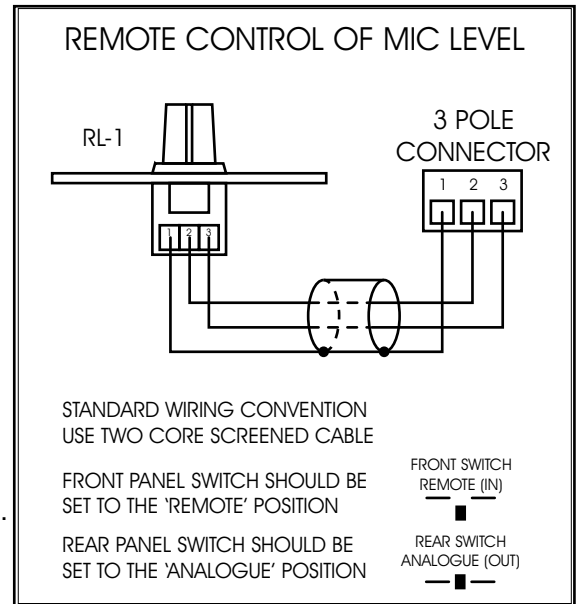

6.4 Microphone Equalisation

Two-band equalisation is provided for each individual microphone input. The pre-set controls to adjust the equalisation are located to the upper-right of each front panel microphone level control. The characteristics of the equalisation are optimised for the tonal correction of speech signals. The HF control provides $\pm 10\text{dB}$ at 5kHz whilst the LF control provides $\pm 10\text{dB}$ at 150Hz.

A parametric equaliser is applied to all the microphone signals, to allow the installer to correct for microphone or room resonance. The pre-set controls to adjust the equalisation are located to the upper-right of the microphone master level control (front panel). This equaliser has been optimised for vocals and provides a gain of $\pm 10\text{dB}$ over a frequency range of 300Hz - 3kHz.

All microphone equalisation controls are concealed behind the removable front panel. To effectively bypass an equalisation section, the gain control should be set to 0dB (mid-position/vertical).

6.5 High Pass Filter

All microphone channels pass through a high pass filter operating at 150Hz with a slope of 18dB per octave; as such it provides effective attenuation of breath blasts and LF handling noises. This filter can be switched in or out via the front-panel switch located to the right of the microphone master level control. This switch will be concealed when the removable front panel is in place.

6.6 Microphone 1 Priority

Microphone 1 can be given priority over microphones 2-4. This feature can be triggered in two ways, selected through the position of internal jumper J17:

- ◆ ‘AVO’: priority is given when a signal is detected on the mic 1 input.
- ◆ ‘ACC’: priority is given when mic 1 access is selected via the microphone access contacts on the rear panel.

Microphone 1 priority jumpers

- J16: Mic 1 over music signal/access triggered.
- J17: Mic1 over mics signal/access triggered

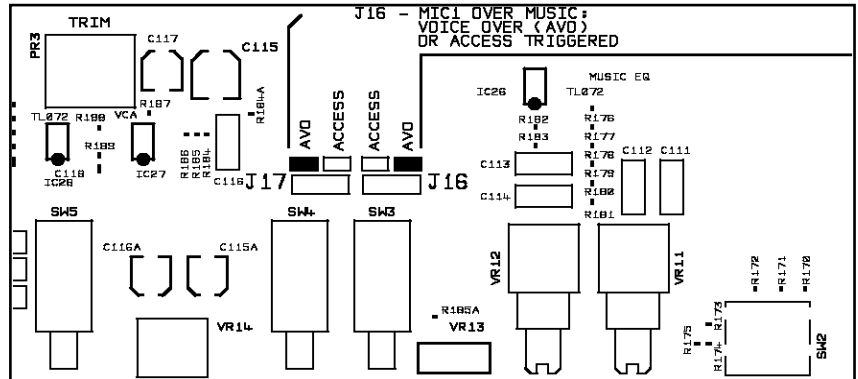

Location of Jumpers J16 & J17

Note that J17 should only be set to access triggered priority if you intend to use the MIC 1 rear panel access contact. Priority is switched in or out via the front panel switch marked 'MIC 1 OVER MICS'. All priority controls are concealed when the removable front panel is attached.

6.7 Microphone over Music priority

The CX462 provides a facility whereby microphone signals can be given priority over music signals. When a signal is detected on any of the mic inputs, all music signals are attenuated to a level determined by the front panel attenuation control. Once there is no microphone signal present, the music will restore to the previous settings.

The priority circuitry can be set to detect the presence of a mic signal either before or after the "Add Mic" front panel rotary control by setting internal jumper J15 to PRE or POST. If the priority circuitry is set before this control(PRE), then the music signals will attenuate regardless of whether any microphone signal is fed through to the stereo music output. If the priority circuitry is set after this control (POST) then the music signals will attenuate only if some mic signal is fed into the music output. Note that regardless of this jumper setting the priority circuitry will attenuate the music level in *both* mic and music outputs.

Microphone 1 can be configured to take priority via the access contacts on the rear panel, rather than voice detected triggering. To permit this, internal jumper J16 must be set to the 'ACCESS' position (see above diagram for location of J16). Note that J16 should only be set to the 'ACCESS' position if you intend to use the Mic 1 rear panel access contact (see section 6.1).

The degree to which music signals are attenuated can be set via the front panel attenuation control, which ranges from -10dB to -60dB. Setting the front panel switch marked 'MIC OVER MUSIC' to the 'OFF' position will defeat the Microphone priority circuit. All priority controls are concealed when the removable front panel is attached.

7 Output Details

Each output terminal is balanced, using a 3 pole 'Phoenix' type connector and can operate into loads as low as 600Ω. The nominal output level is 0dBu (775mV) but the mixer can operate with a wide range of signals up to a maximum output level of +20dBu (7.75V). For balanced interconnections, two-core screened cable should be used. Connect the screen to pin 1, the reverse phase signal (normally blue or black) to pin 2 and the in-phase signal (normally red) to pin 3. If you wish to connect any zone output to an unbalanced input, connect the cable screen to pin 1 with the hot connection (inner core) to pin 3 and make no connection to pin 2.

The music output of the CX462 can operate in either stereo or mono mode. The default setting is for the CX462 to operate in stereo mode. In mono mode, all stereo signal sources are mixed internally and output the same signal to both left and right channel music outputs. The mode can be changed via setting internal jumper J14 to 'MONO' or 'STEREO' as required.

J14: MONO/STEREO music output

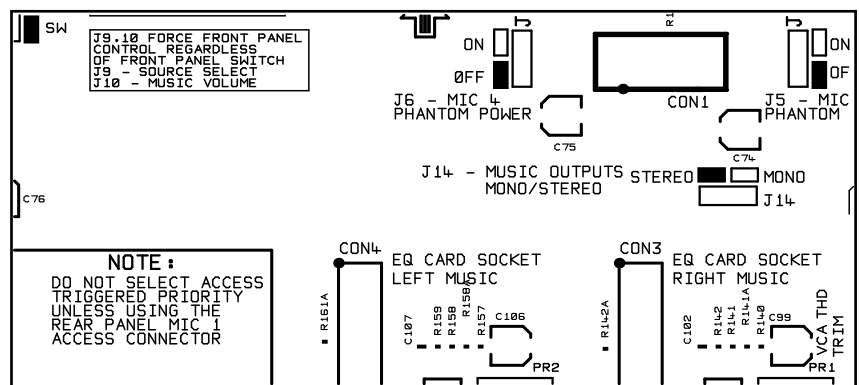

Location of Jumper J14

8 Active Modules - General Specification

Active modules available for the CX462 include Active Equalisation modules and the Cloud CDI-S100 Serial Interface Module. The CX462 can provide a maximum of 80mA current to active modules and external devices (such as a CPM paging microphone). Current consumptions of the various modules are detailed in the table below:

Module Description	Current Required
CDI-S100 Serial Interface Module	35mA
BOSE® EQ cards: M8, M32, MA12, 402, 502A, 802, MB4, MB24, 502B, 502BEX	12mA
BOSE® EQ cards: LT3302, LT4402, LT9402, LT9702	17mA
BOSE® EQ card M16	24mA

8.1 Active Equalisation Modules

Each output channel has the facility to connect a plug-in equalisation module.

The internal equalisation module connectors are marked on the main PCB as:

- ◆ **CON3 for Right Music output**
- ◆ **CON4 for Left Music output**
- ◆ **CON5 for Microphone output.**

When the music output is set for mono, using Jumper J14, only one EQ card is required. The card may be fitted to either CON3 or CON4 depending on the output socket you choose to use.

Installation:

1. Switch off the mains supply and remove the CX462's power lead.
2. Remove the unit's top panel
3. Fit the EQ module to the connector. The EQ card board should be perpendicular to the main board.
4. Apply moderate pressure to the EQ card until it locates with a click.
5. Replace the top panel.

NOTE: In mono mode (see section 7), it is possible to use a mono equalization module on only one of the channels, giving one channel with the equalized signal and one without.

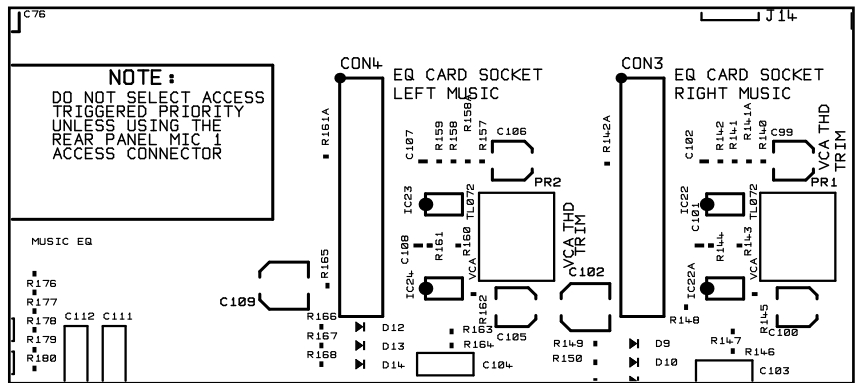

Location of Equalisation Module Connectors CON3 and CON4

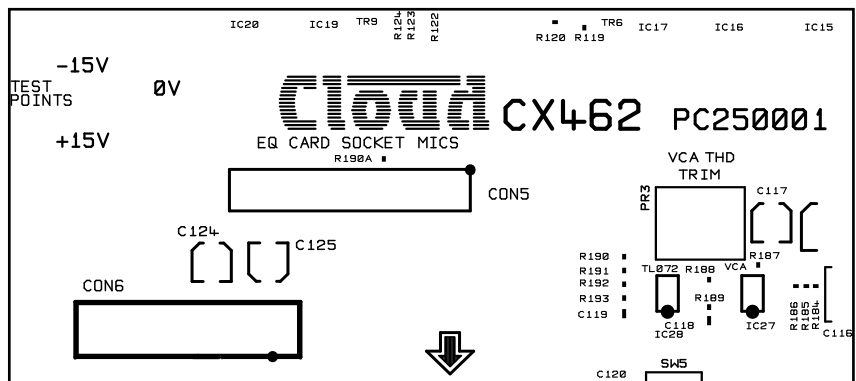

Location of Equalisation Module Connector CON5

8.2 Cloud CDI-S100 Serial Interface Module

The CX462 can be used as part of an automated sound system through the use of the CDI-S100 Serial Interface Module. The module can control:

- ◆ Music source, level and mute
- ◆ Master microphone level
- ◆ Individual microphone mutes

The CDI-S100 module music controls can be defeated via the setting of internal jumpers J7 (source select) and J8 (volume). Setting the front panel switch marked 'LOCAL/REMOTE' to the 'LOCAL' position will defeat remote control of the CX462. The corresponding LED indicates the current state.

Installation:

1. Disconnect mains supply from CX462.
2. Remove top panel from CX462.
3. Remove the panel that blocks the serial interface terminal space when no interface module is installed.
4. Locate connector CON7 (16 pin ribbon)
5. Remove M3 screw behind CON7 and M3 screw left of C96. Keep to one side.
6. Screw 25mm hex spacers into screw holes in step 5.
7. Connect ribbon cable attached to module to CON7 terminal. Pin 1 should be the front right pin.
8. Place module over spacers, making sure to line up the interface socket with the corresponding hole.
9. Use M3 screws, saved from step 3, to firmly affix board to spacers.
10. Set rear panel 'REMOTE TYPE' switch to 'DIGITAL' position.
11. Set front panel 'LOCAL/REMOTE' switch to remote.
12. Check and set internal jumpers J7-10 to configure the module's effect on music signals.
13. Ensure that jumpers J1-4 are in the bypass setting (connection made).

Details on how to operate the CX462 via the CDI-S100 interface are provided in the module manual. The manual will arrive with the module, but can also be requested from info@cloud.co.uk if lost.

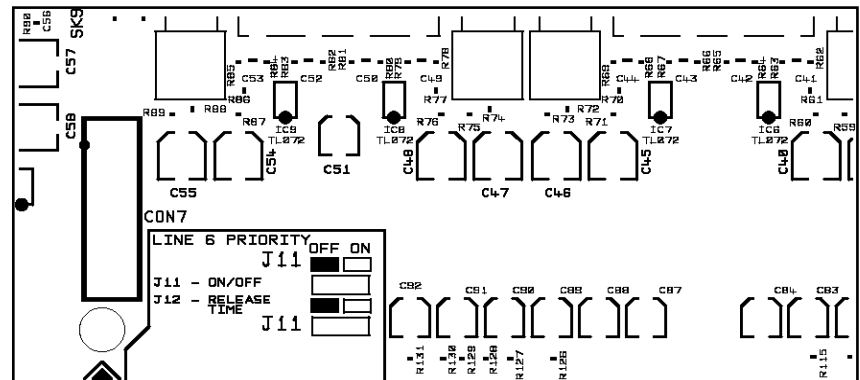

Location of CDI-S100 Serial Interface Module Connector CON7

9 Remote Music Mute - Fire Alarm interface

In certain installations, such as licensed premises or retail outlets within a shopping mall, there may be a local authority or fire service requirement to mute the music signals via a fire alarm control panel in an alarm condition. The CX462 provides a facility to mute the music signals only, by using a fully isolated pair of contacts. This is usually a relay mounted close to the CX462, which is powered by the fire alarm control panel. The relay can either be closed or opened in an alarm condition, but the internal jumper J13 MUST be set to the corresponding position:

- ◆ **N/C:** Alarm condition when the relay opens.
- ◆ **N/O:** Alarm condition when the relay closes.

When setting the jumper(s) please ensure that you:

- **Remove the mains cable from the rear of the product before removing the top panel.**
- **Only reassemble the unit using screws identical to the original parts.**

10 Technical Specifications

Line Inputs

Frequency Response	20Hz-20kHz	+0, -0.5dB
Distortion	<0.03%	80kHz Bandwidth
Sensitivity	100mV (-17.8dBu) to 1.5V (+5.7dBu)	
Input Gain Control	24dB range	
Input Impedance	48k Ω	
Headroom	>20dB	
Noise	-91dB rms	22kHz Bandwidth (0dB gain)
Equalisation	HF: ± 10 dB/10kHz, LF: ± 10 dB/50Hz	

Microphone Inputs

Frequency Response	-3dB@ 30Hz (without filter)	20kHz -0.5dB, +0dB
	-3dB@ 150Hz (with filter)	
Distortion	<0.05%	20kHz Bandwidth
Gain Range	0dB-60dB	
Input Impedance	>2k Ω (balanced)	
Common mode rejection	>70dB 1kHz Typical	
Headroom	>20dB	
Noise	-128dB rms EIN	22kHz Bandwidth
Equalisation	HF: ± 10 dB/5kHz LF: ± 10 dB/150Hz	

Outputs

Nominal output level	0dBu
Minimum load impedance	600Ω
Maximum output level	+20dBu

11 General Specifications

Power Input	230V/115V ±10%
Fuse Rating	T100mA 230V T200mA 115V
Fuse Type	20mm x 5mm 250V
Dimensions	482.60mm x 44.00mm(1U) x 152.5mm
Weight(kg)	2.5

12 Troubleshooting

12.1 Ground/Earth Loops

Despite your best efforts, if the completed sound system 'hums' you probably have a 'ground loop'; the offending signal source can be found by setting the volume control to minimum then disconnecting the input leads (both left & right channels) on each line input until the 'hum' disappears. This problem is often caused by terminating a screened input cable into a signal source positioned a significant distance from the CX462.

A good way of avoiding this potential problem is to use signal sources (CD players and the like) that are double insulated with no connection to the mains supply earth. If a signal feed is derived from a second device (a club or microphone mixer for example) it would be perfectly normal to expect this to be earthed; we suggest that a transformer be used to isolate the signal and prevent a noisy loop (see diagrams below)

12.2 Connecting balanced signals to unbalanced line inputs

We recommend the use of a transformer to convert a balanced signal to an unbalanced signal suitable for direct connection to the CX462 line inputs. The transformer should be mounted close to the CX462 and the unbalanced output lead should be kept as short as possible. Where both the source and destination units are earthed, it is important to isolate the primary and secondary windings to avoid a potential ground loop; if there is any doubt about this, we suggest that the balanced cable screen is not connected at the transformer end. RS Components part 210-6447 is a suitable transformer for this application we recommend that the screening can (part number 210-6469) also be fitted to the transformer; Canford Audio supplies a similar transformer (part number OEP Z1604). All transformers should be wired to give a ratio of 1:1.

Balanced to Unbalanced continued

CONVERTING TWO PIECES OF UNBALANCED EQUIPMENT USING A 1:1 RATIO TRANSFORMER

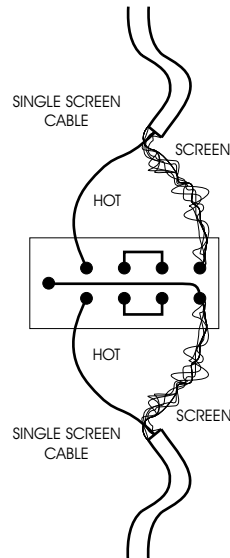

CONVERTING UNBALANCED TO BALANCED USING A 1:1 RATIO TRANSFORMER

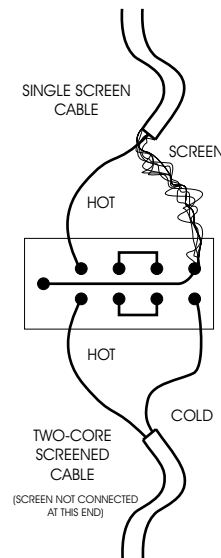

CONNECTING TWO PIECES OF BALANCED EQUIPMENT USING A 1:1 RATIO TRANSFORMER

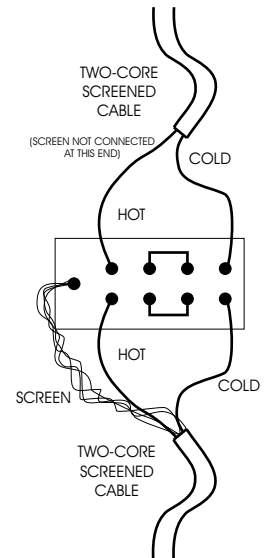

AUDIO TRANSFORMER RS PART NUMBER: 210-6447
FITTED WITH SCREENING CAN RS PART NUMBER: 210-6469

12.3 Cloud CDI-S100 Serial interface is not working properly

In order for the serial interface module to interface correctly with the CX462, there are some aspects which require specific configuration.

- ◆ **Internal jumpers J7 & J10 must be configured to the 'SW' position. Factory default is for jumpers J7 and J8 to be in the 'AN' position which forces music level and source to be controlled by analogue remotes.**
- ◆ **Internal jumpers J1-4 must be set to bypass the rear panel access contacts. Jumpers should be connecting the header pins.**
- ◆ **Verify that the front panel switch marked 'LOCAL/REMOTE' is set to the 'REMOTE' position.**
- ◆ **The rear panel switch marked 'REMOTE TYPE' should be in the 'DIGITAL' position.**

If the module is still not working correctly once these aspects of the CX462 unit have been configured, consult the module manual for details of the serial port connections and the communications protocol.

12.4 Microphone access switches not working correctly

The CX462 leaves the factory configured to bypass the microphone access contacts for all four microphone inputs, so that when the product arrives, all inputs will be enabled. Internal jumpers J1 to J4 bypass access contacts for microphones 1 to 4 respectively. To enable access switching on one of the microphone channels, disconnect the corresponding jumper.

NOTE: We advise that when you remove a jumper you leave it connected to one pin of the header so it remains with the apparatus for future use.

Safety Considerations and Information

The unit must be earthed. Ensure that the mains power supply provides an effective earth connection using a three-wire termination.

When the mains switch is in the off 'O' position the live and neutral conductors of the mains transformer are disconnected.

CAUTION - Installation

Do not expose the unit to water or moisture.

Do not expose the unit to naked flames.

Do not block or restrict any air vent.

Do not operate the unit in ambient temperatures above 35° C.

Do not place liquid filled containers on or around the unit.

CAUTION - Hazardous Live

Do not touch any part or terminal carrying the hazardous live symbol () while power is supplied to the unit.

Terminals to which the hazardous live symbol refers require installation by a qualified person.

CAUTION - Mains Fuse

Replace the mains fuse only with the same type and rating as marked on the rear panel.

The fuse body size is 20mm x 5mm.

CAUTION - Servicing

The unit contains no user serviceable parts. Refer servicing to qualified service personnel.

Do not perform servicing unless you are qualified to do so.

Disconnect the power cable from the unit before removing the top panel and do not make any internal adjustments with the unit switched on.

Only reassemble the unit using screws identical to the original parts.

In the interest of continuing improvements Cloud Electronics Limited reserves the right to alter specifications without prior notice.

Cloud Electronics Limited 140 Staniforth Road Sheffield S9 3HF England
Telephone +44 (0) 114 244 7051 Fax +44 (0) 114 242 5462 E-mail: Info@cloud.co.uk

Notes:
