

Cloud

CVS Series In-Ceiling Loudspeakers

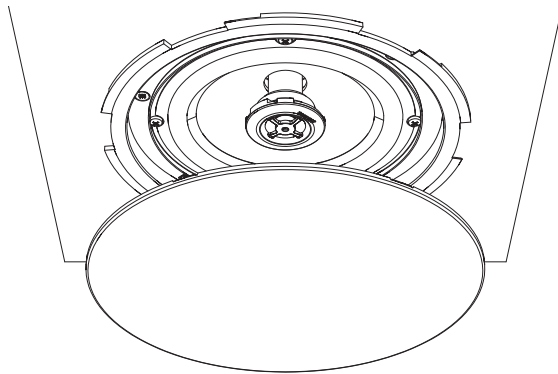

Models

**CVS-C5, CVS-C5T, CVS-C52T, CVS-C53T,
CVS-C62T, CVS-C82T, CVS-C83T**

Installation Guide



CAUTION - Installation

Speaker must be installed by a qualified speaker technician.



CAUTION - Servicing

The unit contains no user-serviceable parts. Refer servicing to qualified personnel. Do not perform servicing unless you are qualified to do so.



CAUTION - Tap Settings

Before use, check that the transformer is set to the correct power tapping for the system.

INFORMATION

Model	Rated power	Max Power	Cut-out diameter	Depth required above ceiling	Line transformer power tappings (100 V-line) or impedance
CVS-C5	10 W	20 W	169 mm (6.65")	65 mm (2.56")	16 ohms
CVS-C5T	10 W	20 W	169 mm (6.65")	65 mm (2.56")	6 W / 3 W / 1.5 W / 8 ohms
CVS-C52T	20 W	40 W	169 mm (6.65")	65 mm (2.56")	6 W / 3 W / 1.5 W / 8 ohms
CVS-C53T	20 W	40 W	169 mm (6.65")	65 mm (2.56")	24 W / 12 W / 6 W / 8 ohms
CVS-C62T	25 W	50 W	205 mm (8.07")	105 mm (4.13")	24 W / 12 W / 6 W / 8 ohms
CVS-C82T	25 W	50 W	241 mm (9.49")	92 mm (3.62")	24 W / 12 W / 6 W / 8 ohms
CVS-C83T	25 W	50 W	248 mm (9.76")	110 mm (4.33")	24 W / 12 W / 6 W / 8 ohms

Note: all model numbers are suffixed either 'B' or 'W'. This refers to the colour of the finish: 'B' = black, 'W' = white.

All models have integral front grilles, with the exception of Models CVS-62T and CVS-83T, which have removable front grilles.

Step 1

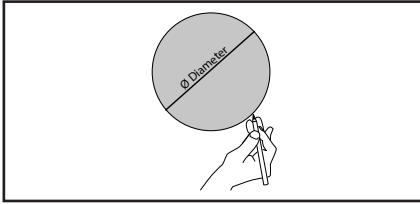

Cut a hole at the mounting location in the ceiling using the template supplied. You can check that the diameter is correct for the model by referring to the table above.

Double check that there are no cables or other obstructions behind the mounting surface before making the cut-out.

Step 2

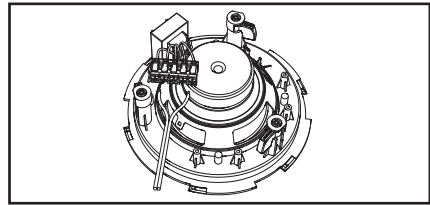

Strip the ends of the wires coming from the amplifier and insert in the spring-loaded terminal block connector on the loudspeaker. No screwdriver is required.

The correct power tapping is chosen by connecting to the appropriate terminals of the connector. A description of the power tap selection is shown on the magnet sticker on the rear side of the loudspeaker.

When using 100/70/25 V speakers in low impedance mode (8Ω), disconnect the ground wires by interrupting the cable lugs.

Step 3

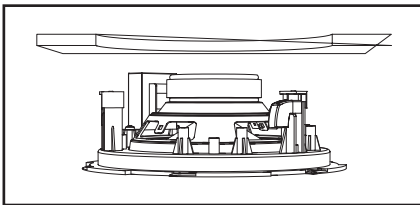

Make sure the mounting clamps are fully bent inwards, allowing the speaker fit through the cut-out. Insert the speaker to the opening.

Step 4

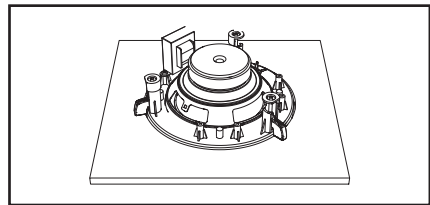

Fix the speaker in the provided opening by tightening the screws of the mounting clamps using a screwdriver. A quarter turn will cause the mounting clamps to flip-out, locking the speaker in place. Tighten the screws further until the speaker unit is fully secure.

Step 5 (only applies to models with removable grilles)

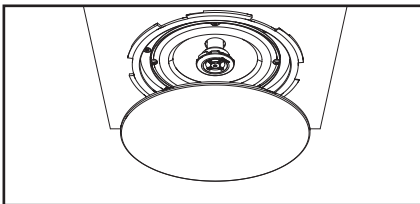

To attach the grill to the speaker, insert the lips into the provided openings on the speaker baffle and rotate it a partial turn (15°) to lock it into place.

Step 6

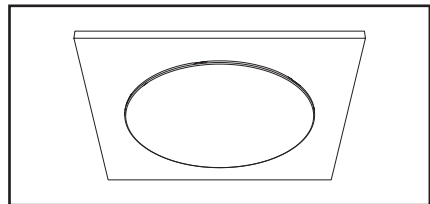

The speaker is now correctly installed and ready for use.