

# CVS CONTRACTOR SERIES LOUDSPEAKERS

## Premium Value Range

MODELS: CVS-C62T, CVS-83T

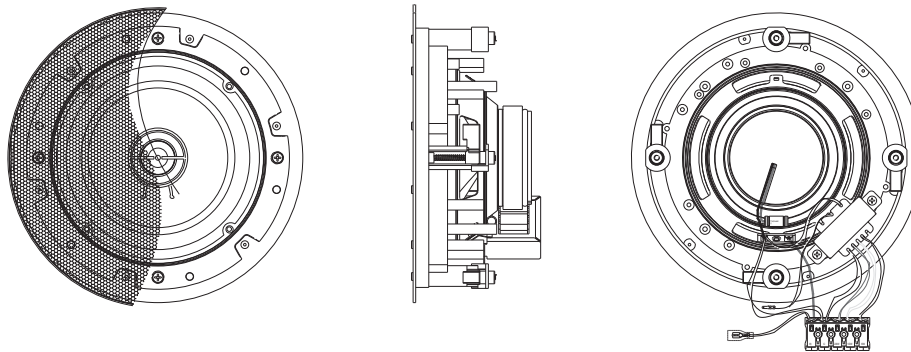

Illustration:  
CVS-C62T

### General Description

The Cloud CVS Contractor Series of cost-effective loudspeakers includes two models specifically designed for high quality music reproduction. They are also suitable for speech and announcements and will find application in pubs and bars where a better quality of music audio is desirable. They are designed for flush in-ceiling installation and are very easy to install, requiring a single circular cut-out in the ceiling or ceiling tile: a cutting template is provided with each loudspeaker. The loudspeakers are fixed in place by four 'dog-ear' clamps which can be actuated and tightened from below with a screwdriver.

The loudspeakers are similar in overall design and specification and differ primarily in diameter. The loudspeakers are of 2-way coaxial design, with an internal crossover. The LF driver cones are polypropylene with a soft rubber surround; the HF drivers are a 1" silk dome tweeter design. This coaxial combination gives a musical response while preserving high speech intelligibility. The CVS-C62T uses a 6½" LF driver and the CVS-C83T an 8" LF driver. Both models are constructed in lightweight ABS plastic with open back, infinite baffle characteristics. They include a 100 V-line transformer with three power tapings, plus the option for low-impedance operation. Connections are made via a multipin "Easy Connect" terminal block on a flying lead.

The loudspeakers may be ordered in black or white. They include a matching painted steel grille which attaches magnetically, making for a very easy finish to the installation and a very clean appearance.

### CVS-C62T/CVS-C83T main features

- High quality coaxial design, optimised for music reproduction
- Simple, in-ceiling mounting: smooth flush finish
- Cutting template supplied
- Magnetic steel grille – easy to fit and remove
- Integral multi-tap transformer for 100 V-line operation
- Low impedance tapping included
- Low profile back can for installation into ceiling voids with limited height
- "Easy Connect" terminal block simplifies installation
- Available in black (CVS-C62TB/CVS-C83TB) or white (CVS-C62TW/CVS-C83TW)
- Available singly or in shipping packs of eight

### Technical Specifications

	CVS-C62T	CVS-C83T
Nominal driver diameter	6½"	8"
Type	2-way coaxial	2-way coaxial
Tweeter design	1" Silk dome	1" Silk dome
Woofer design	6½" polypropylene cone, with soft rubber surround	8" polypropylene cone, with soft rubber surround
Frequency Response (-3 dB)	45 Hz – 20 kHz	45 Hz – 20 kHz
Frequency Response (-10 dB)	40 Hz – 20 kHz	40 Hz – 20 kHz
Crossover frequency	6 kHz	4.2 kHz
Driver impedance	8 ohms	8 ohms
Sensitivity (1 W @ 1m)	88 dBA	88 dBA
Power rating	25 W	25 W
Max power input	50 W	50 W
Transformer taps	24 W, 12 W, 6 W, lo-Z	24 W, 12 W, 6 W, lo-Z
Cutout hole size	205 mm	248 mm
Grille type	Painted steel, magnetically attached	Painted steel, magnetically attached
Enclosure: overall dimensions (dia x height)	224 mm x 90 mm (8.8" x 3.5")	273 mm x 101 mm (10.75" x 4")
Net weight	1.6 kg (3.6 lb)	2.1 kg (4.7 lb)
Shipping weight	per unit	1.9 kg (4.25 lb)
	per pack of 8	14.8 kg (33.15 lb)
		2.3 kg (5.15 lb)
		18.5 kg (41.5 lb)

## Loudspeaker Dimensions

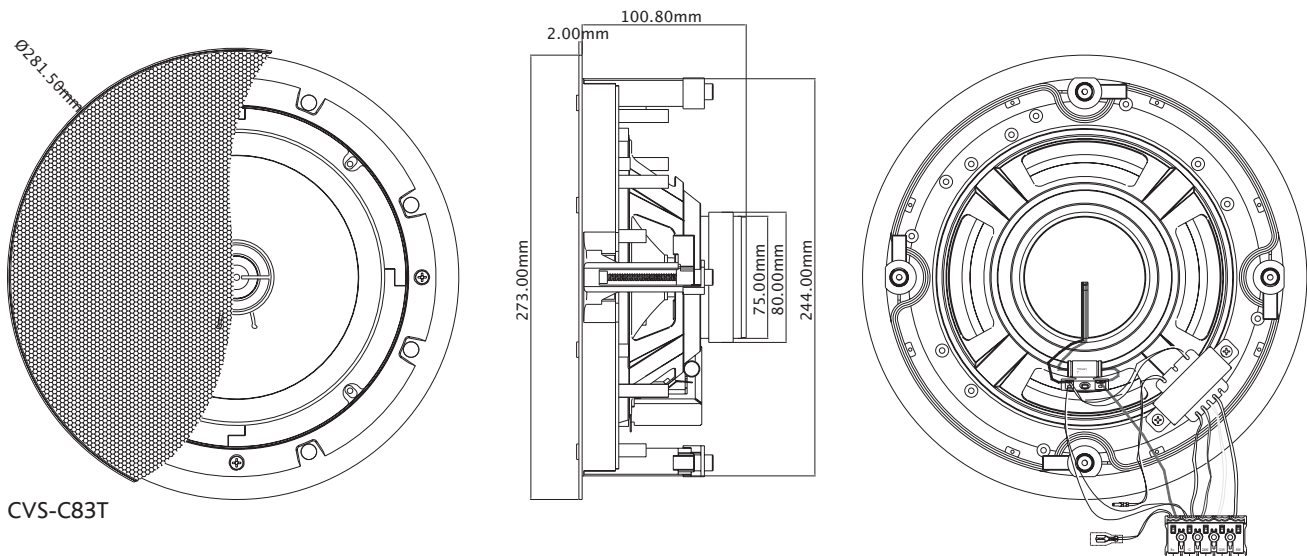

CVS-C83T

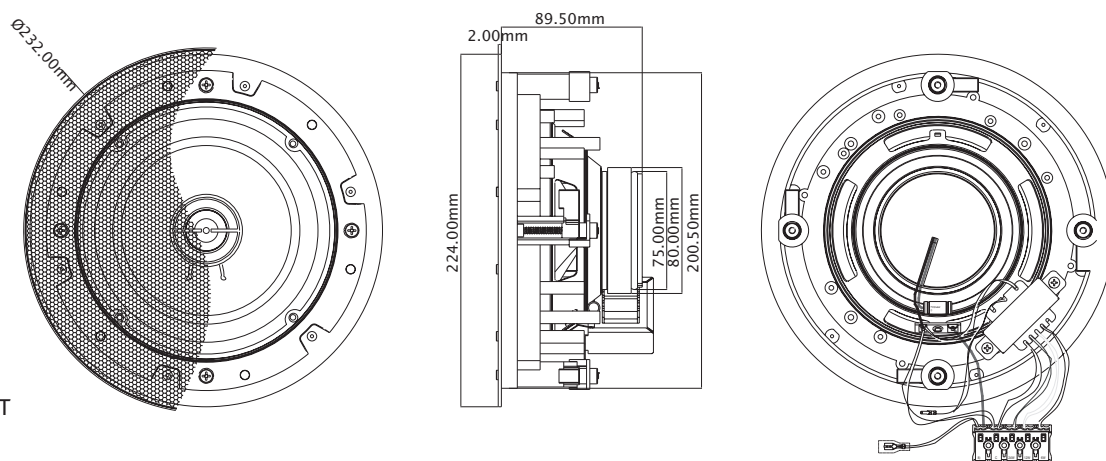

CVS-C62T

## Architect's and Engineer's Specification

Each loudspeaker shall consist of an open-back enclosure in ABS plastic containing a drive unit and acoustic damping material of high impact plastic. It shall incorporate an integral clamping system of the 'dog-ear' type, allowing the enclosure to be fitted into a blind wall or ceiling void with only a screwdriver. It shall include a removable steel grille which attaches to the loudspeaker assembly by means of magnets and shall provide a smooth and clean appearance after fitment.

The enclosure shall not require more than 105 mm of height above/behind the ceiling or wall to permit it to be fitted into restricted spaces. Installation of the loudspeaker shall require only one hole to be cut in the mounting surface. A template shall be packed with each loudspeaker to facilitate this cutout.

Two versions shall be available, with a 6½" or 8" LF driver respectively. The loudspeakers shall be equipped with a transformer suitable for connection to a 100 V-line loudspeaker system, and the transformer shall have at least three different power tapings. It shall also be possible to bypass the transformer and use the loudspeaker in a low-impedance system.

The loudspeakers shall be of two-way coaxial design, and include an integral crossover network. The LF driver cone shall be constructed of polypropylene with a soft rubber suspension and the HF driver shall be a silk dome type of not less than 1" diameter. The loudspeakers shall be capable of delivering an SPL of 88 dBA from an input signal of 1 W power, measured at 1 m on-axis.

Electrical connections to the loudspeakers shall be via a terminal block on a flying lead and the terminal block shall not require special-purpose tools to effect a secure connection.

The loudspeakers shall be available with either a white or a black finish.

The loudspeakers shall be the following models in the Cloud CVS Series:

- CVS-C62TW – 6½" coaxial driver, 100 V-line transformer with tapings for 6 W, 12 W and 24 W, white finish
- CVS-C62TB – 6½" coaxial driver, 100 V-line transformer with tapings for 6 W, 12 W and 24 W, black finish
- CVS-C83TW – 8" coaxial driver, 100 V-line transformer with tapings for 6 W, 12 W and 24 W, white finish
- CVS-C83TB – 8" coaxial driver, 100 V-line transformer with tapings for 6 W, 12 W and 24 W, black finish