

GB8

User Guide





IMPORTANT

Please read this manual carefully before using your mixer for the first time.



This equipment complies with the EMC directive 89/336/EEC Modified by 92/31/EEC 93/68/EEC 91/263/EEC and LVD 73/23/EEC modified by 93/68/EEC

This product is approved to safety standards:

IEC 60065: 2001
EN60065:2002
UL6500 7th Edition: 2003
CAN/CSA-E60065-03

And EMC standards
EN55103-1: 1996 (E2)
EN55103-2: 1996 (E2)

For further details contact:

Harman International Industries Ltd.
Cranborne House, Cranborne Road
Potters Bar, Hertfordshire, EN6 3JN, UK

Tel: +44 (0) 1707 665000
Fax: +44 (0) 1707 660742
e-mail: info@soundcraft.com

© Harman International Industries Ltd. 2004

All rights reserved

Parts of the design of this product may be protected by worldwide patents.

Part No. ZM0308-03

Soundcraft is a trading division of Harman International Industries Ltd. Information in this manual is subject to change without notice and does not represent a commitment on the part of the vendor. Soundcraft shall not be liable for any loss or damage whatsoever arising from the use of information or any error contained in this manual.

No part of this manual may be reproduced, stored in a retrieval system, or transmitted, in any form or by any means, electronic, electrical, mechanical, optical, chemical, including photocopying and recording, for any purpose without the express written permission of Soundcraft.



Harman International Industries Limited
Cranborne House
Cranborne Road
POTTERS BAR
Hertfordshire
EN6 3JN
UK

Tel: +44 (0)1707 665000
Fax: +44 (0)1707 660742

<http://www.soundcraft.com>

Contents

Introduction	5
Key Features	6
Warranty	7
Installation	9
SAFETY SYMBOL GUIDE	9
Fitting the GB8 Meterbridge	10
IMPORTANT SAFETY WARNINGS	11
Mains Installation	13
WORKING SAFELY WITH SOUND	15
Setting Up & Troubleshooting	16
Optional External Power Supply	17
Audio Connector Pinouts	18
Dimensions	19
Block Diagrams	21
	22
	23
Using The Console	25
Mono Input	26
Stereo Input	28
Master Section	31
Rear Connector Panel	33
Typical Specifications	35
Mark-up Sheets	37

NOTE: This equipment has been tested and found to comply with the limits for a Class A digital device, pursuant to Part 15 of the FCC Rules. These limits are designed to provide reasonable protection against harmful interference when the equipment is operated in a commercial environment. This equipment generates, uses and can radiate radio frequency energy and, if not installed and used in accordance with the instruction manual, may cause harmful interference to radio communications. Operation of this equipment in a residential area is likely to cause harmful interference in which case the user will be required to correct the interference at his own expense.

This Class A digital apparatus meets the requirements of the Canadian Interference-Causing Equipment Regulations.

Cet appareil numérique de la Classe A respecte toutes les exigences du Règlement sur le matériel brouilleur du Canada.

Introduction

Key Features

Thank you for buying the GB8 mixing console. its main features are:

Dual purpose console.

Individually switched 48V phantom power on every mono input module.

4 STE channels per frame size.

8 Aux sends (all switchable between pre/post fader operation).

8 Group sends (paired).

4 Stereo returns.

4 Mute Groups.

11x4 Output Matrix.

Limiter on Record Output and Alternative Stereo Output.

GB30 mic pre-amp.

4-band GB30 EQ.

Meter Bridge with accurate VU meters for LEFT, RIGHT and CENTRE Outputs.

Integral power supply, with an external power supply link option.

All metal TRS jacks and Neutrik XLRs.

Direct outputs on all mono input channels.

Warranty

- 1 Soundcraft is a trading division of Harman International Industries Ltd.
End User means the person who first puts the equipment into regular operation.
Dealer means the person other than Soundcraft (if any) from whom the End User purchased the Equipment, provided such a person is authorised for this purpose by Soundcraft or its accredited Distributor.
Equipment means the equipment supplied with this manual.
- 2 If within the period of twelve months from the date of delivery of the Equipment to the End User it shall prove defective by reason only of faulty materials and/or workmanship to such an extent that the effectiveness and/or usability thereof is materially affected the Equipment or the defective component should be returned to the Dealer or to Soundcraft and subject to the following conditions the Dealer or Soundcraft will repair or replace the defective components. Any components replaced will become the property of Soundcraft.
- 3 Any Equipment or component returned will be at the risk of the End User whilst in transit (both to and from the Dealer or Soundcraft) and postage must be prepaid.
- 4 This warranty shall only be available if:
 - a) the Equipment has been properly installed in accordance with instructions contained in Soundcraft's manual; and
 - b) the End User has notified Soundcraft or the Dealer within 14 days of the defect appearing; and
 - c) no persons other than authorised representatives of Soundcraft or the Dealer have effected any replacement of parts maintenance adjustments or repairs to the Equipment; and
 - d) the End User has used the Equipment only for such purposes as Soundcraft recommends, with only such operating supplies as meet Soundcraft's specifications and otherwise in all respects in accordance Soundcraft's recommendations.
- 5 Defects arising as a result of the following are not covered by this Warranty: faulty or negligent handling, chemical or electro-chemical or electrical influences, accidental damage, Acts of God, neglect, deficiency in electrical power, air-conditioning or humidity control.
6. The benefit of this Warranty may not be assigned by the End User.
7. End Users who are consumers should note their rights under this Warranty are in addition to and do not affect any other rights to which they may be entitled against the seller of the Equipment.

Installation

For your own safety and to avoid invalidation of the warranty please read this section carefully.

SAFETY SYMBOL GUIDE

For your own safety and to avoid invalidation of the warranty all text marked with these symbols should be read carefully.



WARNINGS

The lightning flash with arrowhead symbol, is intended to alert the user to the presence of un-insulated “dangerous voltage” within the product’s enclosure that may be of sufficient magnitude to constitute a risk of electric shock to persons.



CAUTIONS

The exclamation point within an equilateral triangle is intended to alert the user to the presence of important operating and maintenance (servicing) instructions in the literature accompanying the appliance.



NOTES

Contain important information and useful tips on the operation of your equipment.



HEADPHONES SAFETY WARNING

Contain important information and useful tips on headphone outputs and monitoring levels.

Fitting the GB8 Meterbridge

The meter bridge is packed at one end of the box, within a cut-out in the protective foam packing material. There are also 5 screws provided in a bag.

Ensure that the GB8 is disconnected from the mains before fitting the meter bridge.

First you need to connect the ribbon cable.

Position the meter bridge as shown in Fig. 1 below. This will allow you to connect the meter bridge's ribbon cable to the matching connector in the GB8. The ribbon cable may have been tucked up into the meter bridge for shipping; if it has, gently extend the cable to its full length below the meter bridge before attempting to connect it.

Fig. 1

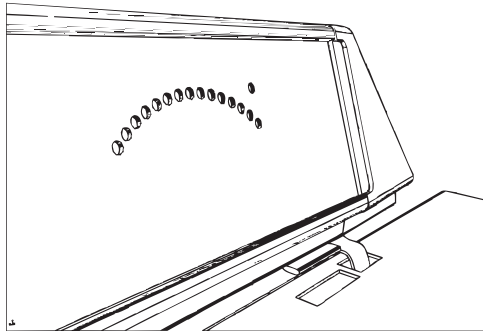

Plug the ribbon cables connector into the matching connector on the GB8. The connectors are shaped so that you cannot connect them the wrong way round. Ensure that the connectors are firmly pushed together so that the contacts are correctly seated.

When you have connected the cable you will have to tuck the excess length back into the meter bridge otherwise it may get trapped between the meter bridge and the top of the GB8.

Next you need to assemble the meterbridge to the GB8. Locate the metal claws on the meter bridge into the rectangular holes on the top of the GB8. You will have to tip the meter bridge forward to locate the claws. See Fig. 2.

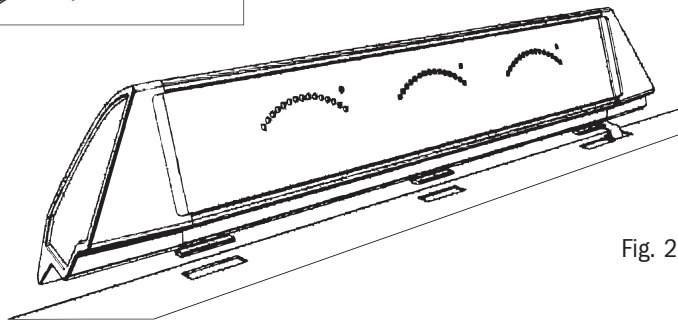
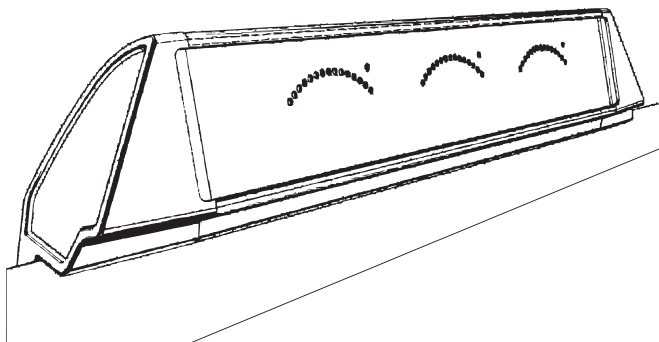

Fig. 2

Fig.3



When the claws are located in the holes tip the meter bridge back to its upright position. Ensure that the ribbon cable hasn't been trapped. See Fig.3.

Secure the back of the meter bridge to the GB8 using the five screws provided. See Fig. 4 below.

Fig.4

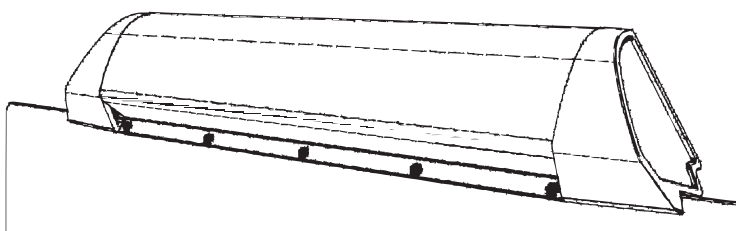

This completes the installation of the meter bridge.

IMPORTANT SAFETY WARNINGS

THIS UNIT MUST BE EARTHED

Under no circumstances should the mains earth be disconnected from the mains lead.

The wires in the mains lead are coloured in accordance with the following code:

Earth:	Green and Yellow (Green/Yellow - US)
Neutral:	Blue (White - US)
Live:	Brown (Black - US)

As the colours of the wires in the mains lead may not correspond with the coloured markings identifying the terminals in your plug, proceed as follows:

- The wire which is coloured Green and Yellow must be connected to the terminal in the plug which is marked with the letter E or by the earth symbol.
- The wire which is coloured Blue must be connected to the terminal in the plug which is marked with the letter N.
- The wire which is coloured Brown must be connected to the terminal in the plug which is marked with the letter L.

Ensure that these colour codings are followed carefully in the event of the plug being changed.

To avoid the risk of fire, replace the mains fuse only with the correct value fuse, as marked on the rear panel.

The internal power supply unit contains no user serviceable parts. Refer all servicing to a qualified service engineer, through the appropriate Soundcraft dealer.

WARNINGS

- Read these instructions.
- Keep these instructions.
- Heed all warnings.
- Follow all instructions.
- This unit contains no user serviceable parts. Refer all servicing to a qualified service engineer, through the appropriate Soundcraft dealer.
- Clean the apparatus only with a dry cloth.
- Do not install near any heat sources such as radiators, heat resistors, stoves, or other apparatus (including amplifiers) that produce heat.
- Do not block any ventilation openings. Ventilation should not be impeded by covering the ventilation openings with items such as newspapers, table cloths, curtains etc. Install in accordance with the manufacturer's instructions.
- Do not use this apparatus near water. The apparatus must not be exposed to dripping or splashing. Objects containing liquid must not be placed on the apparatus.
- The disconnect device is the mains plug; it must remain accessible so as to be readily operable in use.
- THIS APPARATUS MUST BE EARTHED. Under no circumstances should the safety earth be disconnected from the mains lead.
- Do not defeat the safety purpose of the polarized or grounding type plug. A polarized plug has two blades with one wider than the other. A grounding type plug has two blades and a third grounding prong. The wide blade or the third prong are provided for your safety. When the provided plug does not fit into your outlet, consult an electrician for replacement of the obsolete outlet.
- Protect the power cord from being walked on or pinched particularly at plugs, convenience receptacles and the point where they exit from the apparatus.
- Only use attachments/accessories specified by the manufacturer.
- Unplug this apparatus during lightning storms or when unused for long periods of time.



- Refer all servicing to qualified service personnel. Servicing is required when the apparatus has been damaged in any way such as power-supply cord or plug is damaged, liquid has been spilled or objects have fallen into the apparatus, the apparatus has been exposed to rain or moisture, does not operate normally or has been dropped.
- It is recommended that all maintenance and service on the product should be carried out by Soundcraft or its authorised agents. Soundcraft cannot accept any liability whatsoever for any loss or damage caused by service, maintenance or repair by unauthorised personnel.



- If a trolley is used to carry this apparatus, use caution when moving the trolley / apparatus combination to avoid injury from tip-over.
- No naked flame sources, such as lighted candles, should be placed on the apparatus.
- Warning: To reduce the risk of fire or electric shock, do not expose this apparatus to rain or moisture. Do not expose the apparatus to dripping or splashing and do not place objects filled with liquids, such as vases, on the apparatus.

General Precautions

Avoid storing or using the mixing console in conditions of excessive heat or cold, or in positions where it is likely to be subject to vibration, dust or moisture. Do not use any liquids to clean the fascia of the unit: a soft dry cloth is ideal.

Avoid using the console close to strong sources of electromagnetic radiation (e.g. video monitors, high-power electric cabling): this may cause degradation of the audio quality due to induced voltages in connecting leads and chassis.

Caution! In all cases, refer servicing to qualified personnel.

Handling and Transport

The console is supplied in a strong carton. If it is necessary to move it any distance after installation it is recommended that this packing is used to protect it. Be sure to disconnect all cabling before moving. If the console is to be regularly moved we recommend that it is installed in a foam lined flightcase. At all times avoid applying excessive force to any knobs, switches or connectors. You will have to remove the Meter Bridge to get it back into its carton.

Power Cable

Always use the power supply cable supplied with the mixer: the use of alternative cables may cause damage and voids the warranty.

W a r n i n g ! In the event of an electrical storm, or large mains voltage fluctuations, immediately switch off the mixer and unplug from the mains.

Signal Levels

It is important to supply the correct input levels to the console, otherwise signal to noise ratio or distortion performance may be degraded; and in extreme cases, damage to the internal circuitry may result. Likewise, on all balanced inputs avoid sources with large common mode DC, AC or RF voltages, as these will reduce the available signal range on the inputs. Note that $OdBu = 0.775V$ RMS.

Refer to the Specifications section for details of input and output levels.

Mains Installation

General Wiring Procedures

To take full advantage of the excellent signal to noise ratio and low distortion of Soundcraft consoles, care must be taken to ensure that incorrect installation and wiring does not degrade the performance of the desk. Hum, buzz, instability and Radio Frequency interference can usually be traced to earth loops and inferior earthing systems. In some areas, especially heavily industrial areas, the incoming mains earth will not be adequate and a separate technical earth for all the audio equipment must be supplied. However, check with your local electricity supply company to ensure that safety regulations are not infringed or negated.

The successful, hum free, installation of a system requires forethought, and the establishment of a set of ground rules, which must be consistently adhered to at all stages of installation.

Initial Wiring Considerations

For optimum performance, it is essential for the earthing system to be clean and noise free, as all signals are referenced to this earth. A central point should be decided on for the main earth point system, and all earths should be 'star fed' from this point. It is common electrical practice to 'daisy chain' the earths to all electrical outlets but this method is unsuitable for audio installations. The preferred method is to run an individual earth wire from each outlet, back to the system star point to provide a safety earth screen reference for each piece of equipment. A separate earth wire should also be run from each equipment rack and area, to the star point. This may or may not be used depending on circumstances, but it is easier to install in the first place, than later when problems arise. The location of the star point should be a convenient, easily accessible place, preferably at the rear of the console or in the main equipment rack.

Install separate 'clean' and 'dirty' mains outlets, wired individually back to the incoming mains distribution box. Use the 'clean' supply for all audio equipment and the 'dirty' supply for all lighting, etc. Never mix the two systems.

If necessary, to provide sufficient isolation from mains borne interference, install an isolating transformer. This should be provided with a Faraday Shield which must be connected with earth.

Never locate the incoming mains distribution box near audio equipment, especially tape recorders, which are very sensitive to electro-magnetic fields.

Ensure that all equipment racks are connected to earth, via a separate wire back to the star point.

Equipment which has unbalanced inputs and outputs may need to be isolated from the rack to prevent earth loops.

Audio Wiring

Having provided all equipment with power and earthing connections, consideration must be given to the method of providing audio interconnection and adequate screening of those interconnections. This must be done in a logical sequence to avoid problems and assist in the localisation of problem equipment.

Connect the FOH or Monitor system to the console and check for any hum, buzz, or RFI. Only when you are satisfied with the quietness of the console and the PA system should you proceed with the next step.

Connect stereo or Multitrack Tape recorders, FX and foldback sends one at a time, checking and isolating any connection which degrades performance.

Connect all other peripheral devices.

Connect all microphone lines.

By following this sequence much time and future trouble will be saved, and the result will be a quiet, stable system.

Shielding

Audio equipment is supplied with a variety of input and output configurations, which must be taken into consideration when deciding where the screen connections should be made. There are three sources of unwanted signal being impressed on the screen, which are as follows:

Extraneous electrostatic or electromagnetic fields.

Noise and interference on the earth line.

Capacitive coupling between the screen and signal wires.

To minimise the adverse affects of the unwanted coupling to the signal wires, it is important that the screen is connected at one end only, i.e. the screen must not carry any signal current. Any signal on the wires within the screen will be capacitively coupled to the screen. This current will ultimately be returned to the source of the signal, either directly, if the screen is connected at the signal source end, or indirectly via the earthing system, if the screen is connected at the signal destination end. The indirect connection will cause an increase in high frequency cross-talk, and should be avoided wherever possible.

Therefore, in general, always connect the shield only at the signal source end. In high RF areas, the screen can also be connected to earth via a 0.01 mF capacitor. This will present a short circuit at RF frequencies, thus lowering the effective shield impedance to ground. However, at low audio frequencies the reactance of the capacitor will be sufficiently high not to cause an earth loop problem.

Points to Remember

In all cases, use good quality twin screened audio cable. Check for instability at the output.

Always connect both conductors at both ends, and ensure that the screen is only connected at one end.

Do not disconnect the mains earth from each piece of equipment. This is needed to provide both safety and screen returns to the system star point.

Equipment which has balanced inputs and outputs may need to be electrically isolated from the equipment rack and/or other equipment, to avoid earth loops.

It is important to remember that all equipment which is connected to the mains is a potential source of hum and interference and may radiate both electrostatic or electromagnetic radiation. In addition, the mains will also act as a carrier for many forms of RF interference generated by electric motors, air-conditioning units, thyristor light dimmers etc. Unless the earth system is clean, all attempts to improve hum noise levels will be futile. In extreme cases there will be no alternative but to provide a completely separate and independent 'technical earth' to replace the incoming 'noisy earth'. However, always consult your local electricity supply authority to ensure that safety regulations are not being infringed.

WORKING SAFELY WITH SOUND

Although your new console will not make any noise until you feed it signals, it has the capability to produce sounds which when monitored through an amplifier or headphones can damage hearing over time.

The table below is taken from the Occupational Safety & Health Administration directive on Occupational noise exposure (1926.52):

PERMISSIBLE NOISE EXPOSURE

DURATION PER DAY, HOURS	SOUND LEVEL dBA SLOW RESPONSE
8	90
6	92
4	95
3	97
2	100
1.5	102
1	105
0.5	110
<0.25	115

Conforming to this directive will minimise the risk of hearing damage caused by long listening periods. A simple rule to follow is the longer you listen the lower the average volume should be.

Please take care when working with your audio - if you are manipulating controls which you don't understand (which we all do when we are learning), make sure your monitors are turned down. Remember that your ears are the most important tool of your trade, look after them, and they will look after you.

Most importantly - don't be afraid to experiment to find out how each parameter affects the sound - this will extend your creativity and help you to get the best results.

Recommended Headphone Impedance 200-600 ohms.

Setting Up & Troubleshooting

Initial set-up

Once you have connected up your system (see the sections on connection and wiring earlier in this manual for guidance) you are ready to set initial positions for the controls on your mixer.

Set up individual input channel as follows:

- Connect your sources (microphone, keyboard etc.) to the required inputs and release the MUTE switches. Note: Phantom powered mics should be connected before the 48V is switched on.
- Set Master faders at 0, input faders at 0, route the channels to MIX and set power amplifier level to suit the application. Press the L-R switch in the MONITOR SOURCE part of the master section.
- Provide a typical performance level signal and press the PFL button on the first channel, monitoring the level on the bargraph meters.
- Adjust the input gain until the meter display is in the amber section, with occasional peaks to the first red LED at a typical maximum source level. This allows sufficient headroom to accommodate peaks and establishes the maximum level for normal operation (but see note below).
- Repeat this procedure on other channels as required.
- Listen carefully for the characteristic sound of 'feedback'. If you cannot achieve satisfactory input level setting without feedback, check microphone and speaker placement and repeat the exercise. If feedback persists, it may be necessary to use a Graphic Equaliser to reduce the system response at particular resonant frequencies.

Note: The initial settings should only be regarded as a starting point for your mix. It is important to remember that many factors affect the sound during a live performance, for instance the channel EQ settings or even the size of the audience!

You are now ready to start building the mix and this should be done progressively, listening carefully for each component in the mix and watching the meters for any hint of overload. If this occurs, back off the appropriate Channel Fader slightly until the level is out of the red segments, or adjust the Mix Master Faders. This procedure will ensure that the mixer is set up correctly, with adequate headroom. If more amplification is needed, adjust the power amplifier level controls.

Troubleshooting

No Power

- Is the mains supply present?
- Is the mains lead firmly connected?
- Check the mains fusing
- If only one of the power indicators is illuminated, consult your Soundcraft dealer

Condenser Mic Not Working

- Is the 48V turned on?
- Is the mic plugged into the Mic input?
- Is the mic cable a balanced 3-wire type?

Meters not showing any signal

Has the input gain been set correctly? (see above.)

Is the source connected to the appropriate input socket for the level of signal?

Do you have something connected on the Inserts, and is that external device switched on?

Are the Master faders set at max., are input faders set high enough and is the channel routed to the output being monitored?

Is the MUTE switch released on the relevant channels?

Is the appropriate monitor select switch pressed?

Is there a PFL/AFL pressed on another channel?

No Mix output

Check that the Mix Master Fader is up?

No Monitor output

Is a headphone jack plugged in?

Are the Monitor + Phones controls set high enough?

Is the appropriate monitor select switch pressed?

Headphones Distorting

Are the headphones less than 200 Ω impedance?

Is the Phones level set too high?

Optional External Power Supply

Although the GB8 has its own internal power supply, an external backup power supply (DPS-3) can be connected to provide a backup power supply. There is a dedicated connector on the rear connector panel.

Audio Connector Pinouts

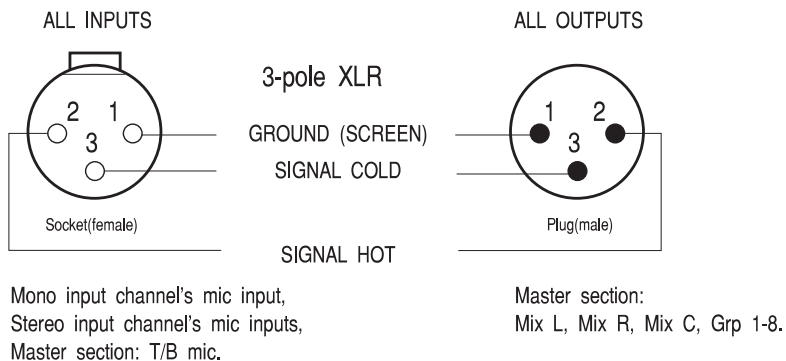

1/4" Stereo Jack Plug used as balanced Input/Output:

All Jacks except headphones and insert points as listed below.

Mono Input Channel: Line Input, Direct Output.

Stereo Input Channel: Line Inputs Left & Right.

Master Section: Left & Right Monitor Outputs, Aux 1-8 Outputs, Matrix 1-4 Outputs, Rec/Alt Outputs, Stereo Return Inputs.

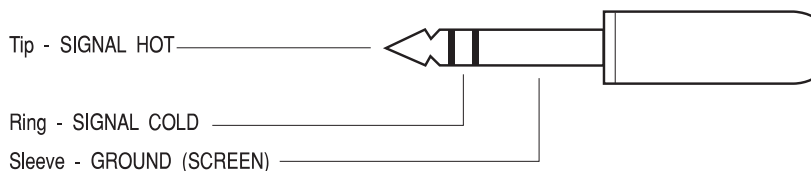

1/4" Stereo Jack Plug used for Headphones

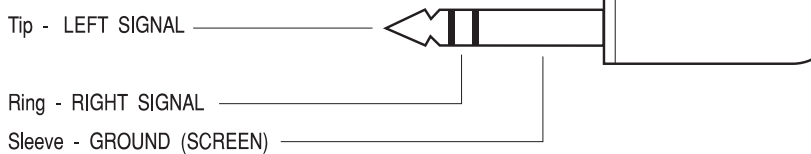

1/4" Stereo Jack Plug used for Insert Point as listed below:

Mono Input, Mix L, Mix R, Mix C, Group 1-8.

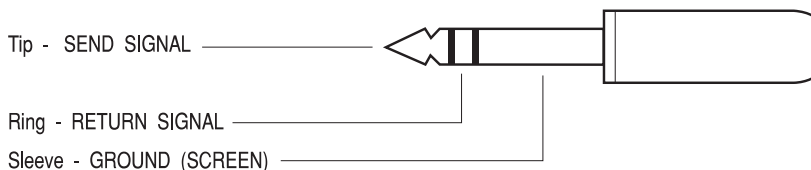

Dimensions

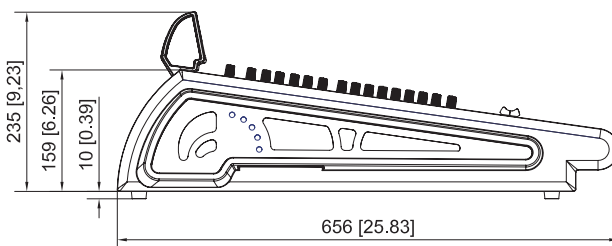
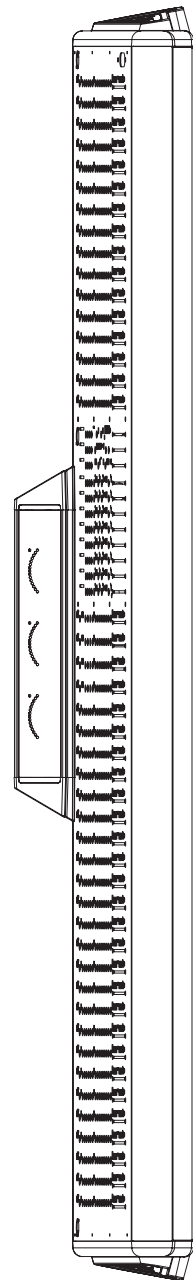
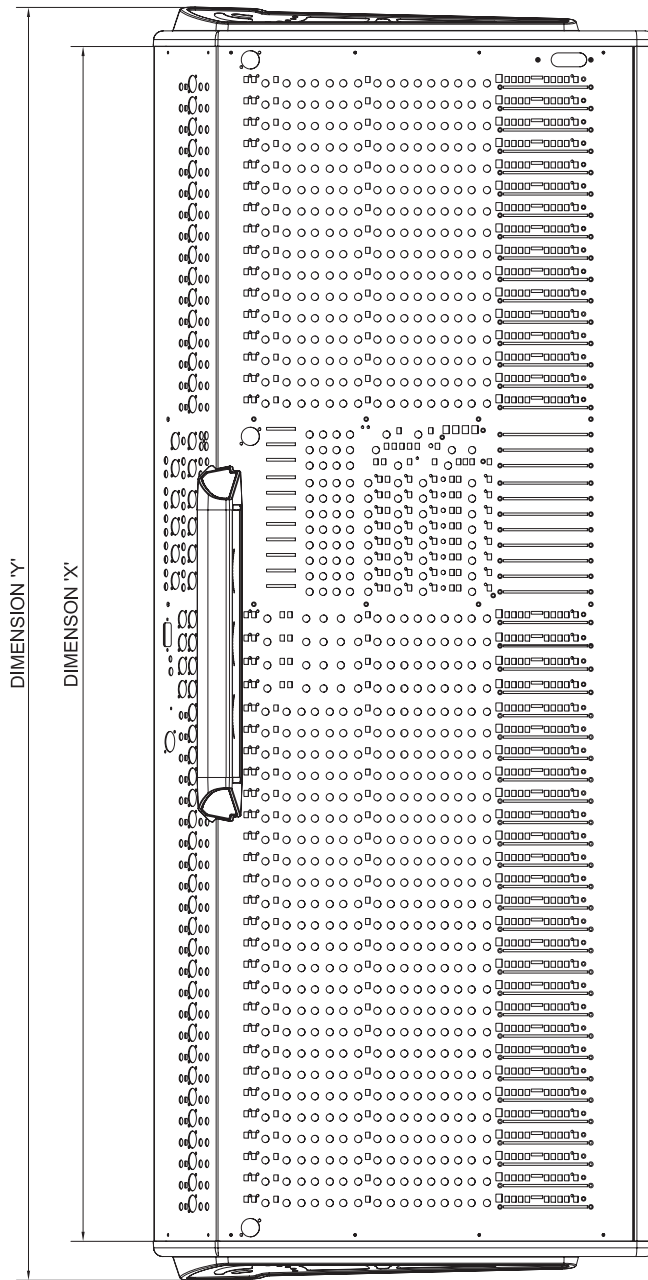

GB8 CONSOLE OVERALL DIMENSION'S		
FRAME SIZE	DIMENSION 'Y'	DIMENSION 'X'
24CH	1208 [47.56]	1106 [43.54]
32CH	1442 [56.77]	1340 [52.75]
40CH	1666 [65.59]	1564 [61.57]
48CH	1889 [74.37]	1787 [70.35]

Block Diagram

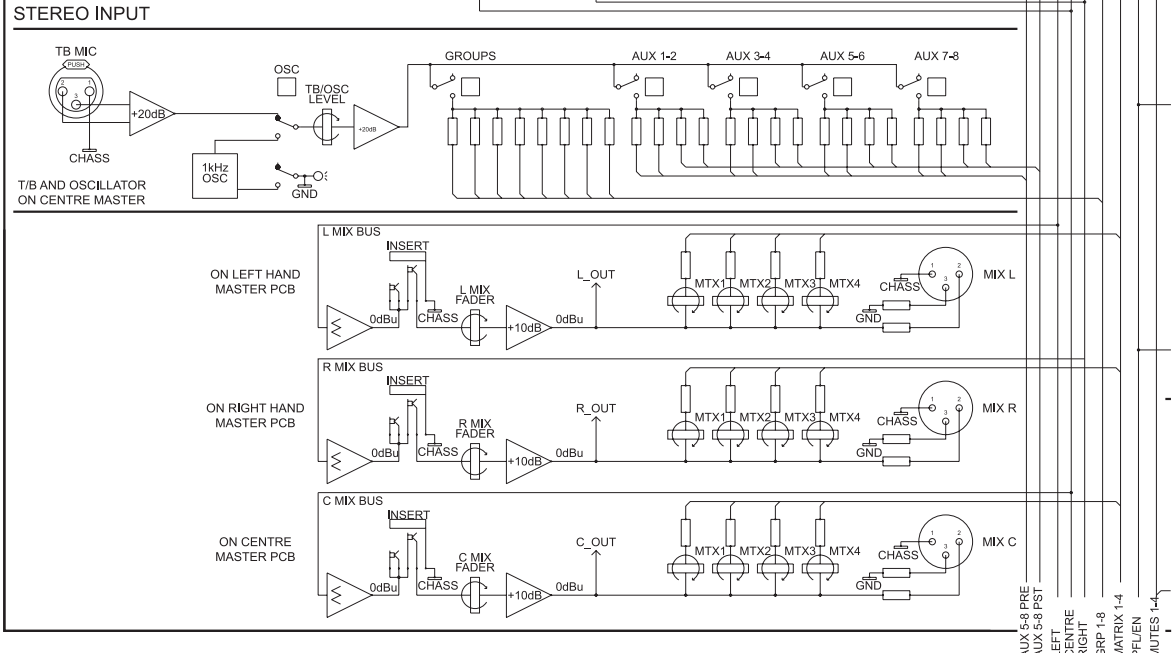
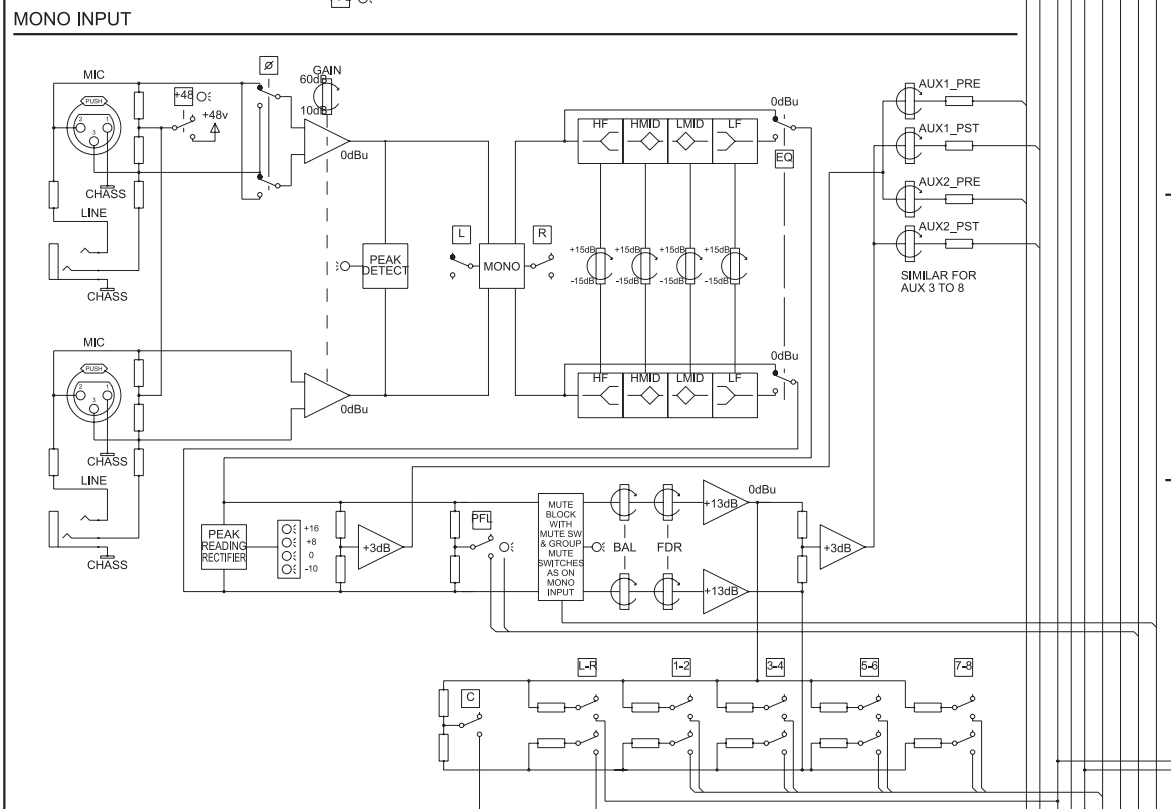
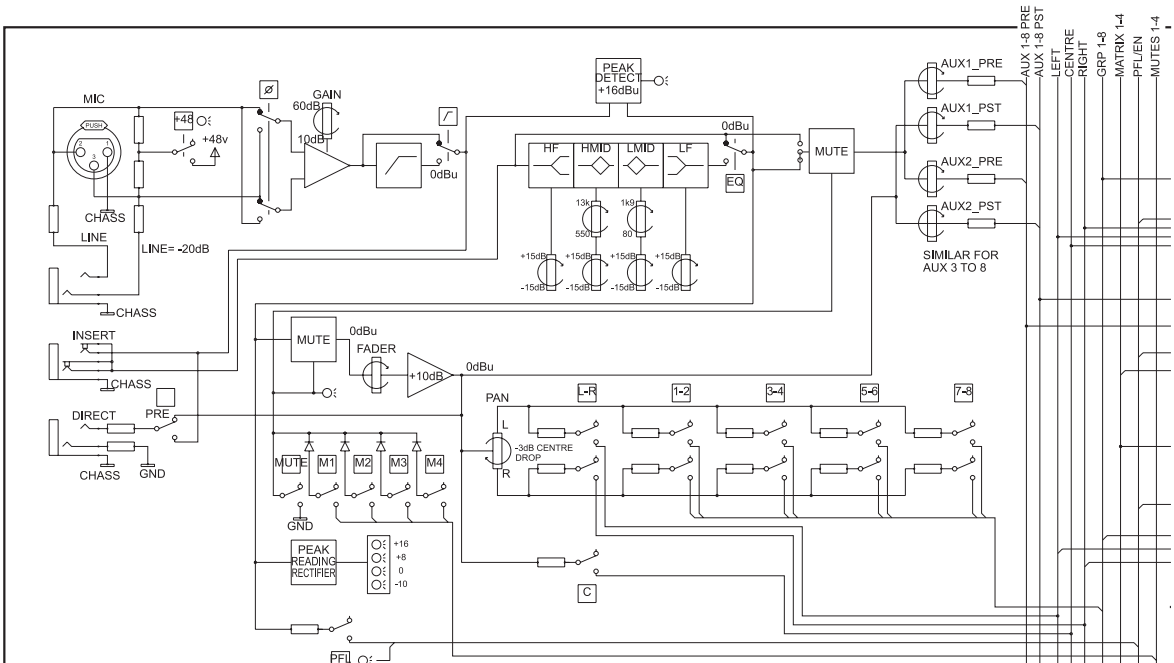

AUX 1-8 PRE
AUX 1-8 PST
LEFT
CENTRE
RIGHT
GRP 1-8
MATRIX 1-4
PFL/EN
MUTES 1-4

AUX 1-8 PRE
AUX 1-8 PST
LEFT
CENTRE
RIGHT
GRP 1-8
MATRIX 1-4
PFL/EN
MUTES 1-4

AUX 5-8 PRE
AUX 5-8 PST
LEFT
CENTRE
RIGHT
GRP 1-8
MATRIX 1-4
PFL/EN
MUTES 1-4

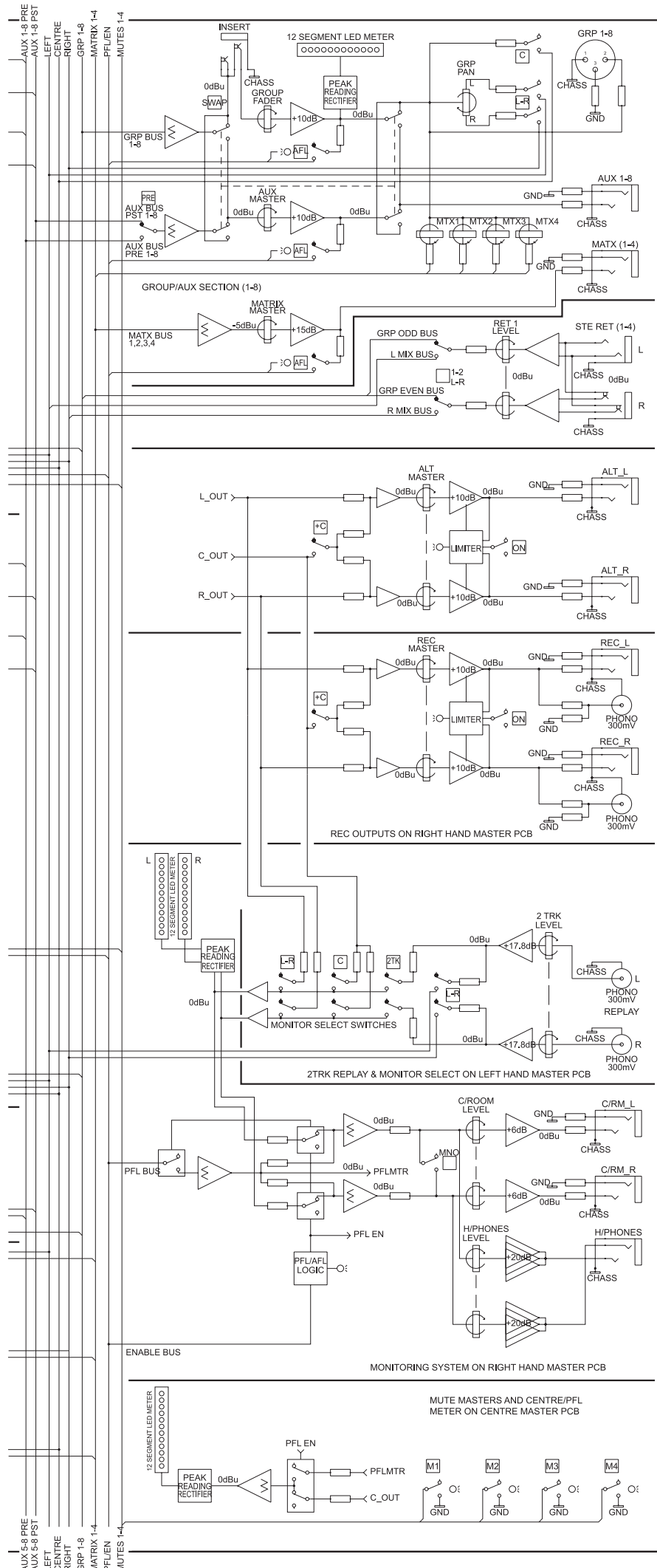

Using The Console

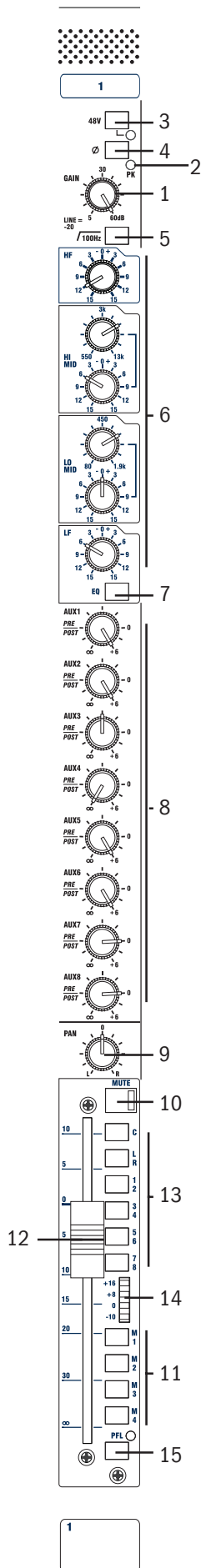

Mono Input

MIC GAIN (1) adjusts the sensitivity of both mic (XLR) and Line (1/4" jack) inputs. Both inputs are electronically balanced, and are located on the rear connector panel.

The PEAK LED (2), monitors two points in the audio path: pre-insert point and post-EQ.

The 48V switch (3) applies 48V phantom power to the input XLR. An adjacent LED indicates when the phantom power is on.

The PHASE switch (4) reverses the phase of the selected input.

HI-PASS (5) switches in the high-pass filter.

The module insert point is pre-EQ, pre-fader. It is located on the rear connector panel.

The EQ section (6) is four band, with shelving HF and LF, and swept peaking high and low mid sections.

The HF and LF sections give +/-15dB cut/boost at 12kHz and 80Hz respectively. The Lo-mid section gives +/-15dB cut/boost at 80Hz-1.9kHz. The Hi-mid section gives +/-15dB cut/boost at 550Hz-13kHz.

The section is switched in by the EQ switch (7).

Signal is sent to the AUX 1-8 busses via individual level pots (8). Each Aux send is globally selectable pre or post fade via switches on the master section. Pre is normally POST-EQ, but may be set to be PRE-EQ via an internal link.

Signal for the L+R (main mix), 1-2, 3-4, 5-6 and 7-8 group busses are routed via the PAN pot (9). The pan pot positions the signal within the stereo image.

The signal in the module is turned on and off by the illuminated MUTE switch (10), and also the master mutes M1-M4 from the master section, if they are selected using the M1 - M4 switches (11).

Post-fader signal level is controlled by a 100mm fader (12).

The signal is sent to the stereo mix bus, centre bus and 8 group busses using the C, L+R, 1-2, 3-4, 5-6 and 7-8 switches (13). Note the use of group 1 & 2, and group 3 & 4; group 5-6 and group 7-8 as 4 sets of stereo pairs.

A 4-segment LED bargraph meter (14), next to the fader, meters the signal post-EQ, pre-mute, pre-fade. The meter has a peak type response.

The PFL switch (15) feeds the pre-mute, pre-fade signal to the monitor output and phones output. An adjacent LED indicates when the PFL is on.

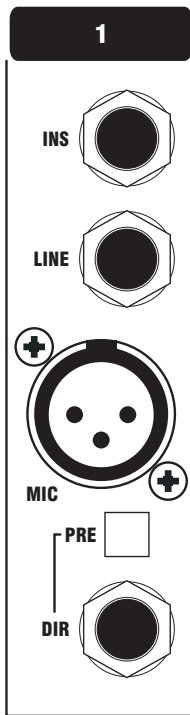

Rear Connectors

INSERT (1/4" TRS Jack)

Tip Send Signal
 Ring Return Signal
 Sleeve Ground

LINE INPUT (1/4" TRS Jack)

Tip Signal Hot
 Ring Signal Cold
 Sleeve Ground

MIC INPUT (3 pin female XLR)

Pin 1 Ground
 Pin 2 Signal Hot
 Pin 3 Signal Cold

DIRECT OUTPUT (1/4" TRS Jack)"

Tip Signal Hot
 Ring Signal Cold
 Sleeve Chassis

The DIRECT OUTPUT is normally post fader. Pressing the PRE button switches it to pre-Insert Point.

Stereo Input

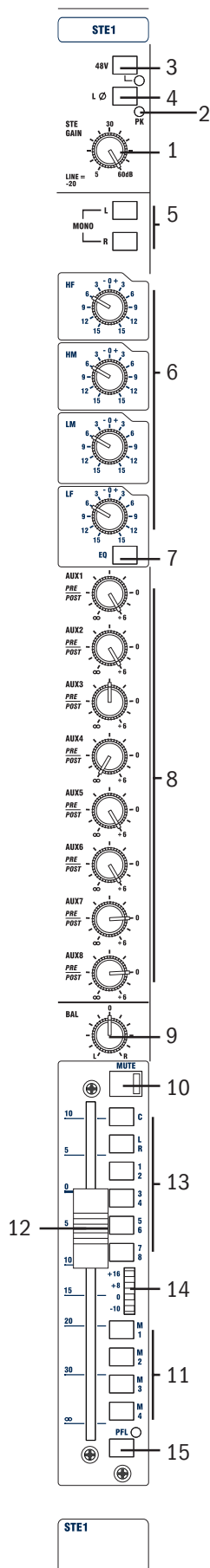

STE GAIN (1) adjusts the sensitivity of both pairs of Mic (XLRs) or Line (1/4" jacks) inputs. Both pairs are electronically balanced, and are located on the rear connector panel.

The PEAK LED (2), monitors both left and right signals after the gain control.

The 48V switch (3) applies 48V phantom power to the input XLRs. An adjacent LED indicates when the phantom power is on.

The Left PHASE switch (4) inverts the phase of the left channel.

The L switch (5) routes the left input signal to both L and R channels in the module. The R switch similarly routes the right input signal. Pressing L and R together mono sums the input.

The EQ section (6) is four band, with shelving high and low frequencies and peaking high-mid and low-mid bands.

The HF control gives +/-15dB cut/boost at 12KHz. The LF control gives +/-15dB cut/boost at 80Hz. The HM control gives +/-15dB cut/boost at a centre frequency of 2.5kHz, and the LM control gives +/-15dB cut/boost at a centre frequency of 450Hz.

The EQ is switched in by the EQ switch (7).

A mono sum of the signal is sent to the AUX 1-8 busses via individual level pots (8). Each Aux send is globally selectable pre or post fade via switches on the master section.

The BAL control (9) allows the stereo image to be balanced between the left and right channels within the module.

The stereo signal in the module is turned on and off by the illuminated MUTE switch (10), and also the master mutes M1-M4 from the master section, if they are selected using the M1 - M4 switches (11).

Post-fader signal level is controlled by a 100mm stereo fader (12).

The signal is sent to the stereo mix bus, centre bus and 8 group busses using the C, L+R, 1-2, 3-4, 5-6 and 7-8 switches (13). Note the use of group 1 & 2, and group 3 & 4; group 5-6 and group 7-8 as 4 sets of stereo pairs.

A 4-segment LED bargraph meter (14), next to the fader, meters the signal post-EQ, pre-mute, pre-fade. The meter has a peak type response.

The PFL switch (15) feeds a mono sum of the pre-mute, pre-fade signal to the monitor output and phones output. An adjacent LED indicates when the PFL is on.

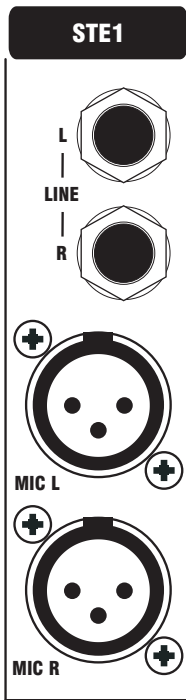

Rear Connectors

MIC INPUT LEFT and RIGHT (3 pin female XLR)

- Pin 1 Ground
- Pin 2 Signal Hot
- Pin 3 Signal Cold

LINE INPUT LEFT and RIGHT (1/4" TRS Jacks)

- Tip Signal Hot"
- Ring Signal Cold"
- Sleeve Ground"



GB 8

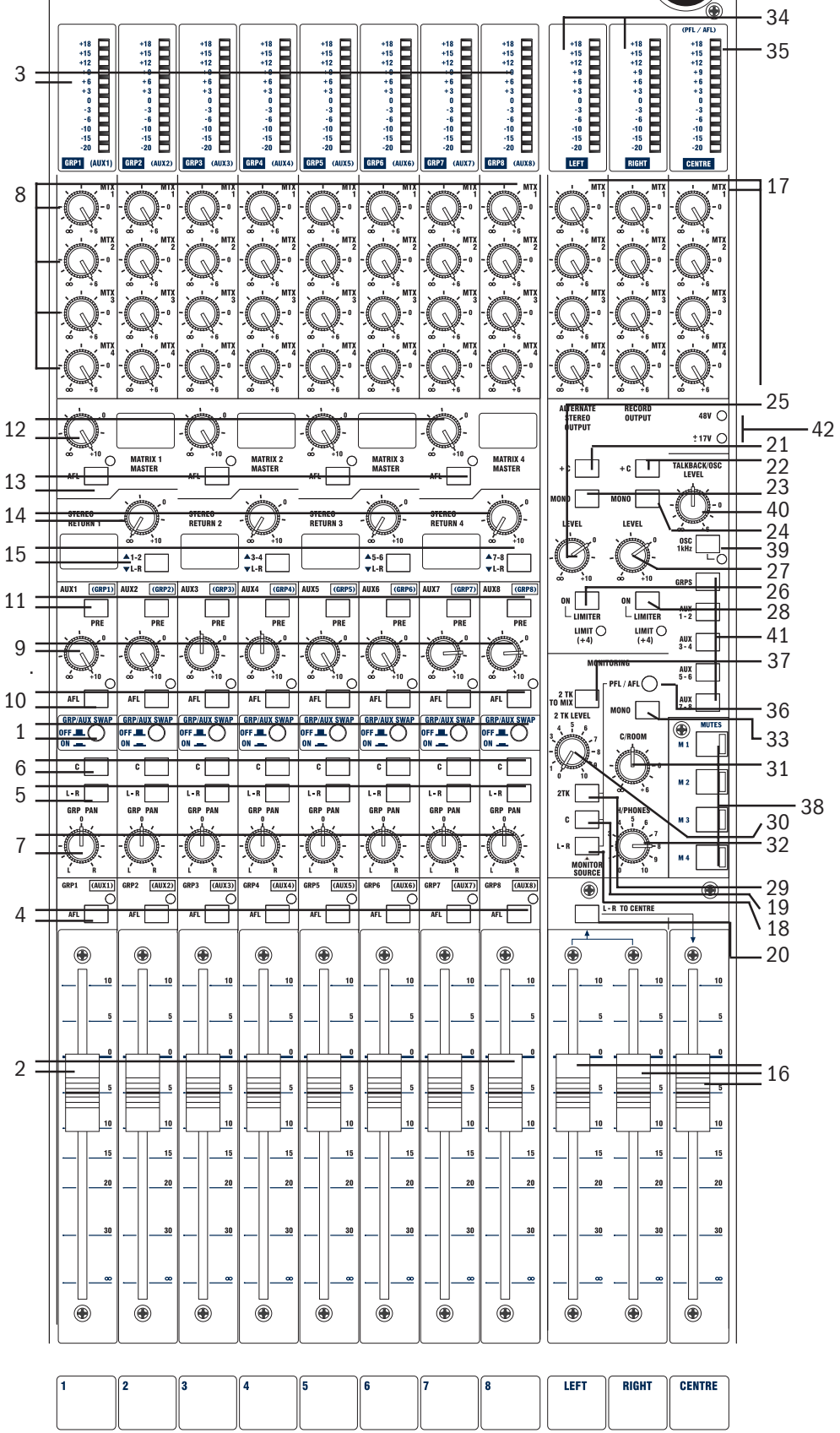

Master Section

GROUPS

Note that the group controls are swappable with the aux 1-8 controls by pressing the GRP/AUX SWAP switches (1). If the controls are swapped the aux and group faders swap function (and their respective AFL buttons) and the group insert point becomes an aux insert point. The 12-segment meter swaps function. The group and aux output connectors retain their original function.

The following description assumes that swap mode is NOT used.

The GRPx fader (2) controls the level after the insert point. This signal is fed to the Group Output XLR on the rear connector panel.

The 12-segment meter (3) monitors the level after the fader.

The AFL button (4) feeds the group post-fader signal to the monitor output and phones output.

The post-fader signal is routed to the main mix stereo pair via the L-R switch (5) and the centre mix via the C switch (6). The Group PAN pot (7) is before the L-R switch in the signal path. It is used to position the group's signal within the stereo image of the main mix.

The post-fader signal may be routed to any or all of the 4 matrix busses via the four matrix input pots (8).

AUX MASTERS 1-8

Aux masters 1-8 are each globally selectable to be pre-fade or post-fade feeds. this is done via the PRE (11) switch.

Each AUX master 1-8 level pot (9) controls the level fed from its own aux bus to its aux output.

The AFL button (10) feeds the aux post-fader signal to the monitor output and phones output.

MATRIX MASTERS

Each MTX MASTER level pot (12) controls the level fed from its own matrix bus to its matrix output.

The AFL button (13) feeds the matrix master post-fader signal to the monitor output and phones output.

STEREO RETURNS

There are 4 stereo returns, the inputs are on 1/4" jacks on the rear connector panel. Each return pair has its own level control (14). Each return pair can be routed either to the main L & R main buses, or to pairs of groups, ie Stereo Return 1 routes to Groups 1 (Left signal) and 2 (Right signal), Stereo Return 2 routes to Groups 3 & 4, etc. This routing is done via the routing switches (15).

L, R & C Outputs

Each of the 3 main mix busses, Left, Right and Centre, has its own insert point. These are located on the rear connector panel. Each mix bus has its own Fader (16) following the insert point in the signal path.

The post-fader signal for each bus is then routed to the following places:

- its main output XLR on the rear connector panel,
- feeds to the matrix 1- 4 buses (17),
- the REC/ALT output section,
- the MONITOR SOURCE select switches L-R (18) and C (19).

A mono sum of the L & R outputs can be routed to the C output via the L-R TO CENTRE switch (20).

REC and ALT Outputs

The ALT output is a stereo pair. Each of the 2 channels (L & R) has its own 1/4" jack on the rear connector panel.

The REC output is also a stereo pair. Each of the 2 channels (L & R) has 2 output connectors on the rear connector panel: an RCA phono socket and a 1/4" jack.

The three feeds to the REC and ALT sections are from the L, R & C main faders (16). The +C switches (21- ALT)(22-REC) feeds the C signal to both L & R channels. The MONO switches (23-ALT)(24-REC) sums both the left and right channels together.

The ALT LEVEL pot (25) feeds the stereo signal to a limiter which can be enabled by the LIMITER ON switch (26), the adjacent LED indicates when the limiter is active. The limiter acts at +4dBu.

The stereo signal is then fed to the rear connector panel.

The REC LEVEL pot (27) feeds its stereo signal to a limiter which can be enabled by the LIMITER ON switch (28), the adjacent LED indicates when the limiter is active. The limiter acts at +4dBu. The stereo signal is then fed to the rear connector panel.

Monitoring & PFL

The monitor section feeds the control room L & R outputs (on the rear connector panel) and the headphones output (right hand front of console).

The sources for the monitor section are:

- the 2-track input (29), its volume is controlled by the 2-TRK LEVEL control (30),
- the centre mix, C (19), and
- the main mix, L-R (18).

Any or all of these sources may be selected at any one time. The monitor signals (L & R) are passed to the control room L & R outputs via the C/ROOM level pot (31), and to the headphones socket via the H/PHONES pot (32). The monitor L & R signals can be mono summed using the MONO switch (33).

The L & R 12-segment meters (34) indicate the level of the monitored signal, as selected by the monitor source select switches. The CENTRE meter (35) monitors the Centre mix output except when any AFL or PFL button is pressed.

When a PFL or AFL button is pressed the CENTRE meter displays the pfl/afl signal level, and the pfl/afl signal is routed to the control room outputs and to the headphones. This signal replaces the normal monitor signal. The PFL/AFL LED (36) illuminates when this is happening.

Note: the 2-track input may also be routed directly to the main L-R mix via the 2 TRK TO MIX switch (37).

Master Mutes

These four switches (38) will mute any input modules which have been assigned to them.

Talkback/Oscillator

The OSC 1kHz switch (39) selects the oscillator or the talkback mic input socket as the signal source. The LED next to the switch indicates when the oscillator is selected.

The talkback mic input is on the rear connector panel.

The level of the talkback mic/oscillator signal is controlled by the TALKBACK/OSC LEVEL pot (40). The signal is fed to all groups, aux 1-2, aux 3-4, aux 5-6 and aux 7-8 using the appropriate buttons (41).

PSU Monitor LEDs

These LEDs (42) confirm the presence of the correct voltage on the +48V and the +/-17V power rails in the console.

Rear Connector Panel

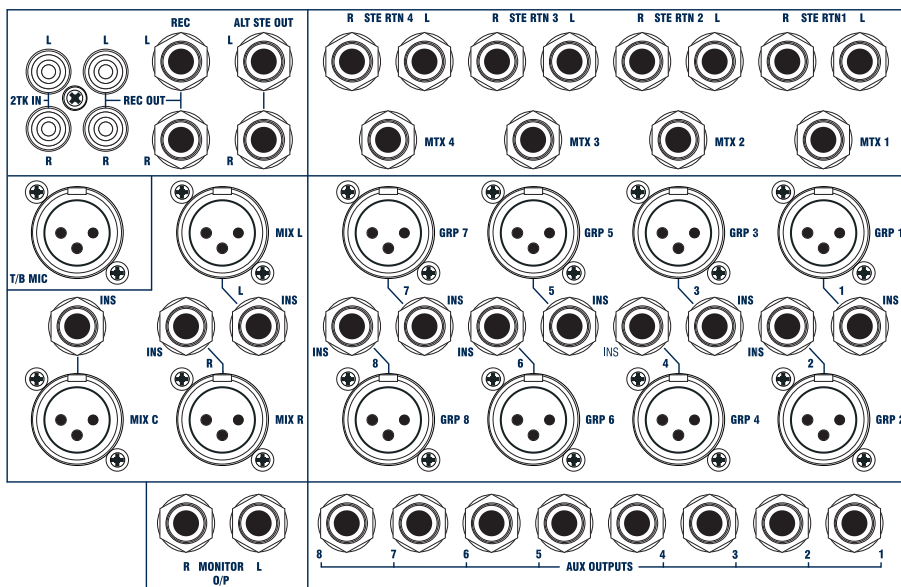

T/B MIC (3-pin female XLR)

- Pin 1 Ground
- Pin 2 Signal Hot
- Pin 3 Signal Cold

MIX L, R & C OUTPUTS (3-pin male XLRs)

- Pin 1 Chassis
- Pin 2 Signal Hot
- Pin 3 Signal Cold

MIX L, R & C INSERT POINTS (1/4" TRS Jacks)

Tip Send Signal
Ring Return Signal
Sleeve Chassis

L & R MONITOR OUTPUTS (1/4" TRS Jacks)

Tip Signal Hot
Ring Signal Cold
Sleeve Chassis

GROUP 1-8 OUTPUTS (3-pin male XLRs)

Pin 1 Chassis
Pin 2 Signal Hot
Pin 3 Signal Cold

GROUP 1-8 INSERT POINTS (1/4" TRS Jacks)

Tip Send
Ring Return
Sleeve Chassis

AUX 1-8 OUTPUTS (1/4" TRS Jacks)

Tip Signal Hot
Ring Signal Cold
Sleeve Chassis

MATRIX 1-4 OUTPUTS (1/4" TRS Jacks)

Tip Signal Hot
Ring Signal Cold
Sleeve Chassis

REC/ALT OUTPUTS (1/4" TRS Jacks and RCA Phonos)

JACK
Tip Signal Hot
Ring Signal Cold
Sleeve Chassis

PHONO
Centre Signal
Screen Chassis

2-TRACK INPUTS (RCA Phono)

Centre Signal
Screen Chassis

STEREO RETURN 1 - 4 INPUTS (1/4" TRS Jacks)

Tip Signal Hot
Ring Signal Cold
Sleeve Chassis

TYPICAL SPECIFICATIONS

Noise: Measured RMS, 22Hz to 22kHz Bandwidth

Mic E.I.N. @ unity gain, 150Ω source impedance	-128dBu
Mix Output, 40 inputs routed to mix	<-82dBu
Group Outputs	<-83dBu
Aux Outputs	<-80dBu
Matrix Outputs	<-89dBu

Crosstalk (@1kHz, typical)

Input Channel Mute	<-97dB
Input Fader cut-off	<-95dB
Pan isolation	<-77dB
Mix route isolation	<-97dB
Group route isolation	<-97dB
Adjacent channel crosstalk	<-99dB
Group to Mix	<-89dB
Aux Send pots offness (typical)	<-84dB
Matrix Send pots offness (typical)	<-84dB

Frequency Response

Mic/Line Input to any output, 20Hz - 20kHz	<1dB
--	------

THD + N

Mic sens. -30dBu, +20dBu at all outputs @1kHz	<0.006%
---	---------

CMRR

Typical @ 1kHz	80dB
----------------	------

Input & Output Max Levels

Mono & Stereo Mic Inputs	+15dBu
Mono & Stereo Line Inputs	+30dBu
Stereo Returns & Insert Returns	+20dBu
Any output	+20dBu
Nominal Operating Level	0dBu
Headphone Power	2x250mW into 200Ω

Input & Output Impedances

Mic Inputs	2kΩ
Line Inputs and Stereo Returns	10kΩ
Mix, Group, Aux, Matrix & Direct outputs	150Ω
Insert Sends	75Ω
Insert Returns	5kΩ
Recommended Headphone Impedance	200 - 600Ω

Mark-up Sheets

