



CSS8004/CSS8008/ CSS8018

With CSS-BB4 and CSS-BB8 Backcans and CSS-TR4/8 Tile Rails

100 mm (4 in) and 200 mm (8 in) Commercial Series Ceiling Speakers for Use with Pre-Install-Type Backcans.

Commercial Series

Key Features:

- ▶ Affordably priced, high-quality dual-cone type ceiling speaker.
- ▶ Pre-assembled speaker / transformer / grille assembly.
- ▶ Suitable for most paging or background music applications, including retail stores, restaurants, schools, and other facilities.
- ▶ Very high sensitivity provides maximum sound levels using minimal amplifier power.
- ▶ Quality triple-voltage transformer (100V, 70V and 25V).
- ▶ Packs of six pieces contain individually packaged speakers for shipping non-pack quantities to jobsite.



JBL's Commercial Series Ceiling Speakers provide excellent performance for paging and background music applications. High sensitivity across the product line provides maximum sound level, even at low tap settings.

Model CSS8004 is a 100 mm (4 in) speaker with 90 dB sensitivity and a 5-Watt multi-tap transformer.

Model CSS8008 is an 200 mm (8 in) speaker with high 96 dB sensitivity, greater bass extension than the CSS8004, and a 5-Watt multi-tap transformer.

Model CSS8018 is a higher-power 200 mm (8 in) speaker, with very high 97 dB sensitivity and a larger 10-Watt multi-tap transformer.

The speaker's pre-attached triple-voltage transformer provides versatility by allowing use on 100V, 70V or 25V distributed loudspeaker lines.

The drivers feature a full 25 mm (1 in) diameter voice coil with a Kapton coil-former and high-temperature wire for better power dissipation and long-term reliability. For installation convenience, the speaker grille and transformer are pre-attached to the driver. Grilles are painted, zinc-plated, cold-rolled steel. The 200 mm (8 in) models feature a standard 286 mm (11¼ in) bolt-mounting diameter. Matching CSS backcans are made of zinc-plated steel with powder-coated finish. CSS steel pre-install backcans can be installed, wired, and inspected prior to installation of the speaker.

Loudspeaker Assemblies:

	CSS8004	CSS8008	CSS8018
Driver Size (dual-cone)	100 mm (4 in)	200 mm (8 in)	200 mm (8 in)
Driver Sensitivity (mid-range) (1W [2.83V], 1m, 2k – 6k Hz)	90 dB	96 dB	97 dB
Frequency Range (-10 dB)	85 Hz – 18 kHz	55 Hz – 16 kHz	50 Hz – 17 kHz
Driver/Grille Assembly: Installed in CSS-BB backcan:	130 Hz – 18 kHz	100 Hz – 16 kHz	90 Hz – 17 kHz
Coverage (2 kHz)	175°	120°	110°
Driver Continuous Power Handling ¹	15 Watts	15 Watts	20 Watts
100V Taps	5W, 2.5W, 1.3W	5W, 2.5W, 1.3W	10W, 5W, 2.5W
70V Taps	5W, 2.5W, 1.3W, 0.7W	5W, 2.5W, 1.3W, 0.7W	10W, 5W, 2.5W, 1.3W
25V Taps	5W, 2.5W, 1.3W, 0.7W	5W, 2.5W, 1.3W, 0.7W	10W, 5W, 2.5W, 1.3W
Transformer Insertion Loss	1.5 dB Maximum	1.5 dB Maximum	1.5 dB Maximum
Transformer Connection	Bare wire	Bare wire	Bare wire
Motor Mass	200 g (7 oz)	200 g (7 oz)	283 g (10 oz)
Safety Agency	Suitable for use in air handling spaces per UL1480, UL2043, NFPA 90 & NFPA 70, when installed with corresponding UL Listed backcan, below. S7232/UL Listed, Signaling Speaker. Transformer UL registered per UL1876. In accordance with IEC60849/EN60849.		
Matching CSS Backcan	CSS-BB4	CSS-BB8 (0.15 cu ft)	CSS-BB8 (0.15 cu ft)
Other Compatible Backcans	n/a	MTC-81BB8 (0.26 cu ft) MTC-200BB6 (0.5 cu ft) MTC-300BB8 (1.0 cu ft)	MTC-81BB8 (0.26 cu ft) MTC-200BB6 (0.5 cu ft) MTC-300BB8 (1.0 cu ft)
Bolt Mounting Circle to Backcan	4 points on 165 mm (6.5 in) diameter	4 points on 286 mm (11.25 in) diameter	4 points on 286 mm (11.25 in) diameter
Cutout Diameter	125 mm (5.0 in)	216 mm (8.5 in)	216 mm (8.5 in)
Open-back: In CSS-BB backcan	170 mm (6.7 in)	295 mm (11.7 in)	295 mm (11.7 in)
Depth (behind grille)	94 mm (3.7 in)	71 mm (2.8 in)	73 mm (2.9 in)
Grille Diameter	198 mm (7.8 in)	327 mm (12.9 in)	327 mm (12.9 in)
Net Weight (ea)	0.90 kg (1.0 lb)	1.27 kg (2.8 lb)	1.58 kg (3.5 lb)
Shipping Weight (ea)	1.26 kg (2.8 lb)	1.94 kg (4.3 lb)	2.25 kg (5.0 lb)
Included Accessories	4 pcs M4 x 40 mm sheet metal screws for attaching speaker/driver/transformer assembly to corresponding backcan.		

¹ Continuous Pink Noise Rating (IEC-shaped pink noise with a 6 dB crest factor, for 100 hrs continuously), 2.83V input level.

JBL continually engages in research related to product improvement. Some materials, production methods and design refinements are introduced into existing products without notice as a routine expression of that philosophy. For this reason, any current JBL product may differ in some respect from its published description, but will always equal or exceed the original design specifications unless otherwise stated.

► CSS8004/CSS8008/CSS8018 Commercial Series Ceiling Speakers

Backcans & Tile Rails

	CSS-BB4	CSS-BB8	CSS-TR4/8
Compatibility	CSS-8004 speaker, CSS-TR4/8 tile rails	CSS-8008 and CSS-8018 speakers, CSS-TR4/8 tile rails	CSS-BB4 and CSS-BB8 backcans
Dimensions	89 deep x 214 diameter mm (3.5 x 8.4 in)	108 deep x 334 diameter mm (4.3 x 13.2 in)	600 x 36 x 8 mm (23.6 x 1.4 x 0.3 in)
Bolt Mount Circle	4 points on 165 mm (6.5 in) diameter	4 points on 286 mm (11.25 in) diameter	n/a
Air Space	1.4 liters (0.05 cu ft)	4.0 liters (0.15 cu ft)	n/a
Material	Steel, zinc-plated, powder-coated	Steel, zinc-plated, powder-coated	Punched/formed steel, zinc-plated
Conduit Knockouts	Five (5) knockouts: 4 on sides spaced at 90° and 1 at center of top panel	Five (5) knockouts: 4 on sides spaced at 90° and 1 at center of top panel	n/a
Attachment Points	4 points on 165 mm (6.5 in) diameter with clip nuts for 4 screws.	4 points on 286 mm (11.25 in) diameter. Clip nuts for 4 screws.	2 points screw onto backcan, each rail.
Safety Agency	Suitable for use in air handling spaces per UL1480, UL2043, NFPA 90 & NFPA 70, when installed with corresponding UL Listed loudspeaker, above. S7232/UL Listed, Signaling Speaker. CUL Listed. In accordance with IEC60849/EN60849.		
Net Weight (ea)	0.38 kg (0.9 lb)	0.87 kg (2.0 lb)	0.18 kg (0.4 lb)
Shipping Weight (ea)	0.47 kg (1.1 lb)	1.04 kg (2.3 lb)	0.21 kg (0.5 lb)
Included Accessories	4 pcs M4 x 8 mm machine screws for attaching two tiles rails to backcan		(M4 x 8 mm machine screws for attaching rails are packaged with backcans)

Frequency Response & Impedance

Transformer bypassed, 10° off-axis (typical for coverage area), driver/grille assembly

CSS8004

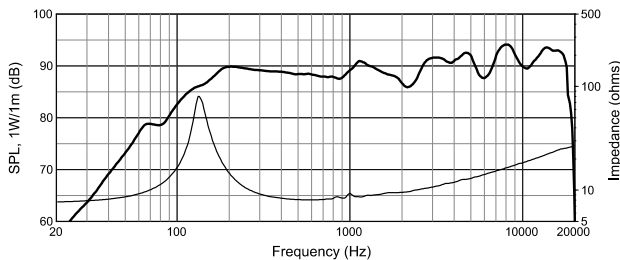

CSS8008

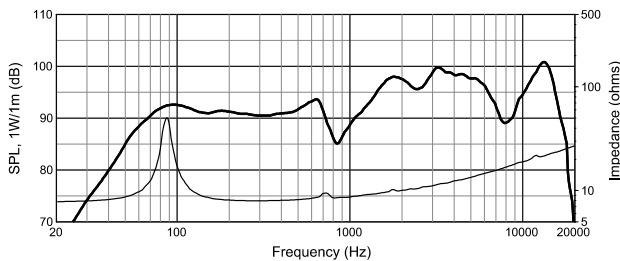

CSS8018

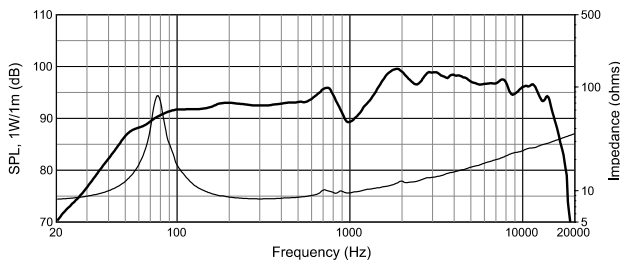

Connection:

CSS8004 and CSS8008

	Orange	Green	Gray	Yellow	Black
25V	0.7W	1.3W	2.5W	5W	COM
	White	Blue	Brown	Orange	Black
70V	0.7W	1.3W	2.5W	5W	COM
100V	1.3W	2.5W	5W	N/C	COM

CSS8018

	Orange	Green	Gray	Yellow	Black
25V	1.3W	2.5W	5W	10W	COM
	White	Blue	Brown	Orange	Black
70V	1.3W	2.5W	5W	10W	COM
100V	2.5W	5W	10W	N/C	COM

Coverage:

CSS8004

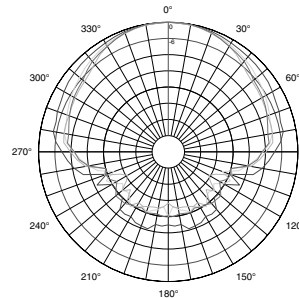
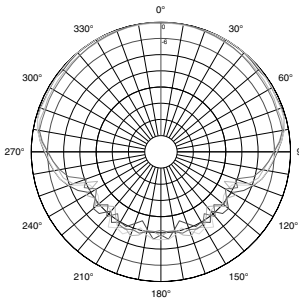
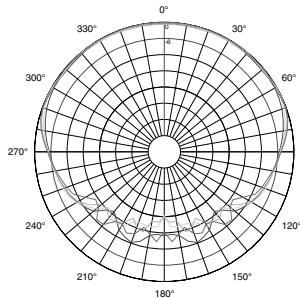

CSS8008

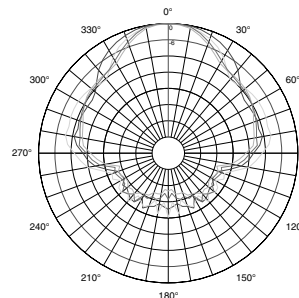
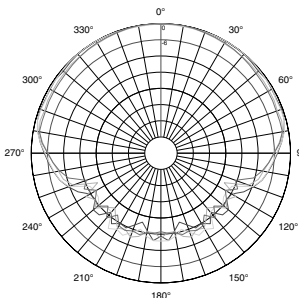
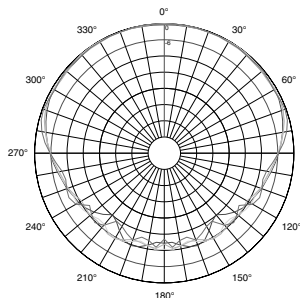

CSS8018

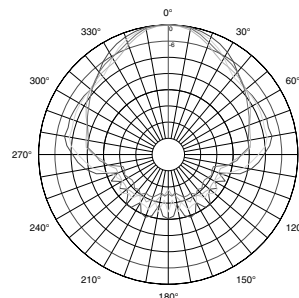
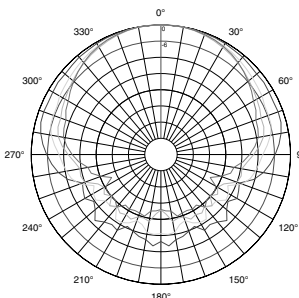
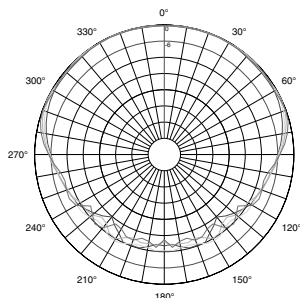

Assembly:

CSS8004

Tile Rails CSS-TR4/8(X2)
Secure rails to ceiling/grids in manner required by local building code.

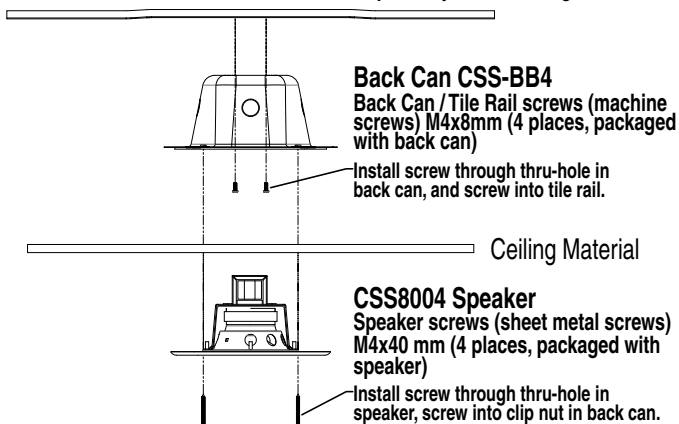

CSS8008 & 8018

Tile Rail CSS-TR4/8(x2)
Secure to ceiling/grids in manner required by local building code.

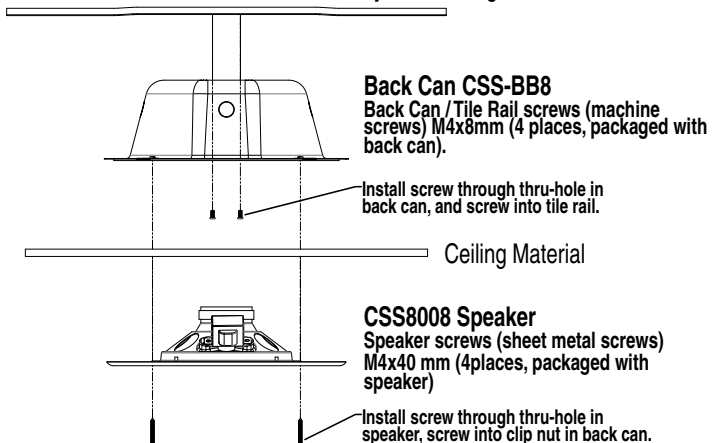

► CSS8004/CSS8008/CSS8018 Commercial Series Ceiling Speakers

Dimensions:

CSS8004

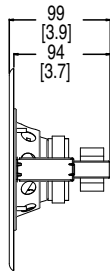
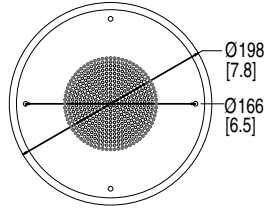

CSS8008 and
CSS8018

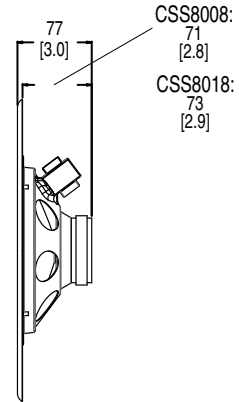
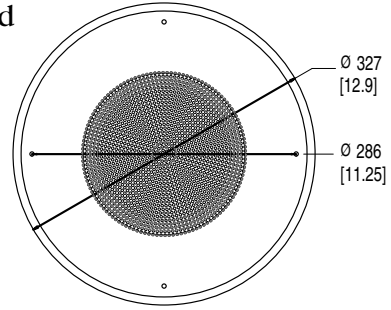

CSS-BB4

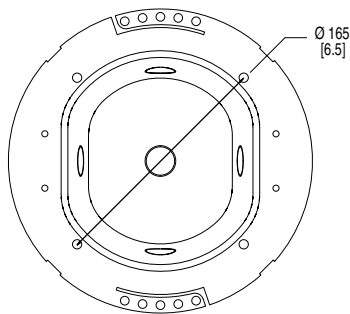
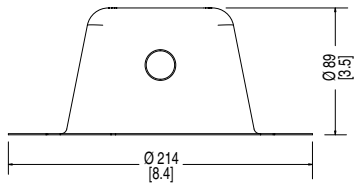

CSS-BB8

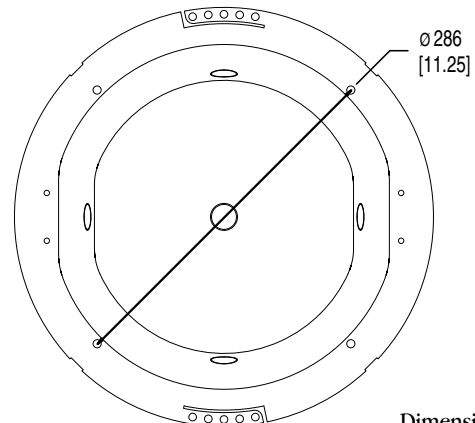
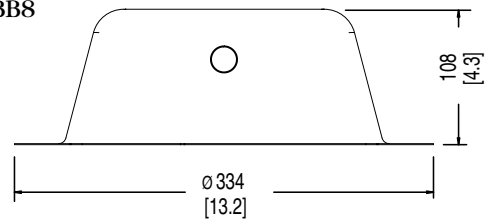

CSS-TR4/8

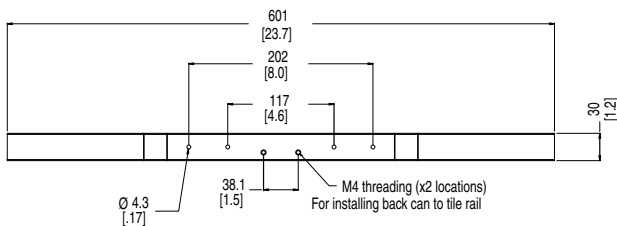

Dimensions in mm (in)



JBL Professional
8500 Balboa Boulevard, P.O. Box 2200
Northridge, California 91329 U.S.A.

© Copyright 2015 JBL Professional
www.jblpro.com

SS CSS CEILING
CRP
08/15