

**datavideo**

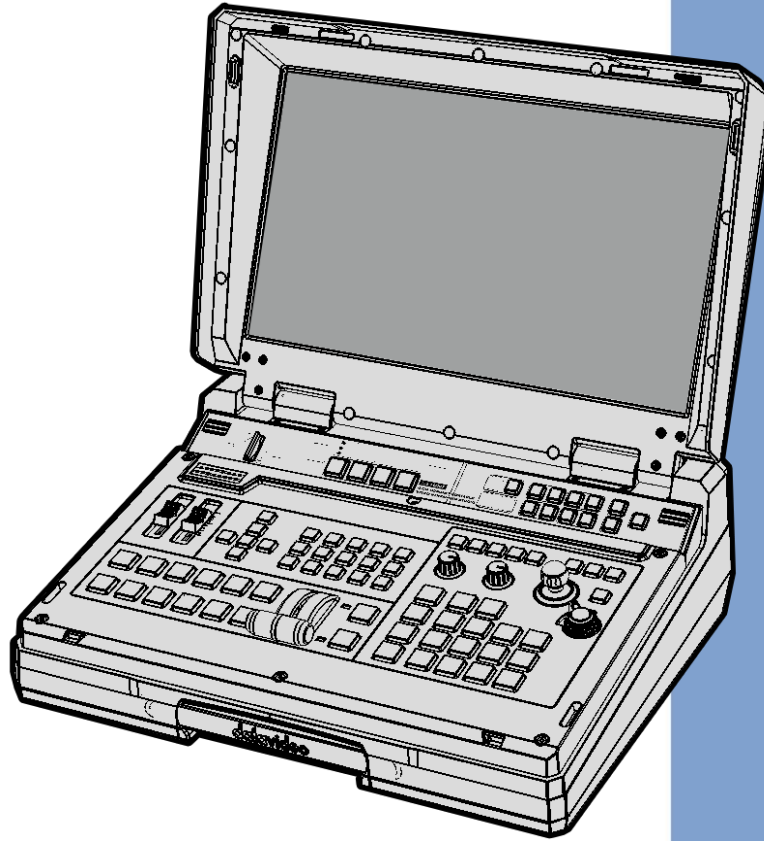

**4 CHANNEL HD/SD  
HDBASET PORTABLE  
VIDEO STREAMING STUDIO  
HS-1600T MARK II  
Instruction Manual**

[www.datavideo.com](http://www.datavideo.com)

# Table of Contents

<b>FCC COMPLIANCE STATEMENT</b> .....	<b>5</b>
<b>WARNINGS AND PRECAUTIONS</b> .....	<b>5</b>
<b>WARRANTY</b> .....	<b>6</b>
<i>STANDARD WARRANTY</i> .....	6
<i>THREE YEAR WARRANTY</i> .....	6
<b>DISPOSAL</b> .....	<b>7</b>
<b>CHAPTER 1 INTRODUCTION</b> .....	<b>8</b>
1.1 FEATURES .....	8
1.2 SYSTEM DIAGRAM .....	9
<b>CHAPTER 2 CONNECTIONS AND CONTROLS</b> .....	<b>10</b>
2.1 REAR PANEL .....	10
2.2 SWITCHER KEYBOARD PANEL .....	13
2.3 MONITOR CONTROL PANEL .....	22
2.4 RECORD/STREAM PANEL .....	23
<b>CHAPTER 3 SWITCHER OSD MENU</b> .....	<b>25</b>
3.1 START .....	25
<i>Transition Type</i> .....	25
<i>Transition Speed</i> .....	25
<i>Wipe Effect</i> .....	26
<i>WIPE Border Size</i> .....	26
<i>WIPE Border Color</i> .....	26
<i>BKG Color</i> .....	26
3.2 PIP / SPLIT.....	26
<i>PIP Source</i> .....	27
<i>PIP Size (PIP Window Size)</i> .....	27
<i>Position X</i> .....	27
<i>Position Y</i> .....	28
<i>Split Source</i> .....	28
<i>Border Size</i> .....	28
<i>Border Color</i> .....	28
3.3 PIP CROP .....	28
3.4 LUMAKEY.....	29
<i>Lumakey Source</i> .....	29
<i>Mode</i> .....	29
<i>Cleanup Level</i> .....	29
<i>Transparency</i> .....	29
3.5 AUDIO.....	30
<i>Mute</i> .....	30
<i>HDMI Input</i> .....	30
<i>HDMI Group</i> .....	30
<i>Level</i> .....	30
<i>Tally Mode</i> .....	30
3.6 USER MEMS.....	31

Load Memory.....	31
Save Memory.....	31
Factory Default.....	31
3.7  SETUP.....	31
PGM Out Res.....	32
MV Out Res.....	32
Output Format.....	33
Save Setup.....	33
Language.....	33
MB and KBD Software.....	33
3.8  CAMERA.....	33
Camera CH. Setup.....	34
PTC-150T-01/02/03.....	34
Camera Info.....	34
Video.....	34
Operator.....	34
<b>CHAPTER 4  MONITOR.....</b>	<b>35</b>
4.1  MENU OPTIONS.....	35
MAIN ADJUST.....	36
COLOR.....	36
Information.....	36
Special Function.....	37
Factory Reset.....	37
<b>CHAPTER 5  APPLICATIONS.....</b>	<b>38</b>
5.1  PLACING A LOGO ON THE VIDEO USING THE LUMAKEY FUNCTION.....	38
5.2  CONNECTING PTC-150T CAMERAS.....	38
<b>CHAPTER 6  VIDEO STREAMING AND RECORDING.....</b>	<b>40</b>
6.1  STREAMING NETWORK CONNECTION AND DEVICE SEARCH.....	40
Connecting to a DHCP Network (DHCP Mode).....	40
Connecting to a NON-DHCP Network (Static IP).....	41
Default Fixed IP.....	41
Troubleshooting the Network Connection.....	41
Advanced Troubleshooting.....	44
6.2  WEB USER INTERFACE.....	45
Source.....	45
Operation Mode.....	46
Stream Mode.....	46
Record Mode.....	51
CG.....	55
CG Layer.....	55
CG Type.....	56
Location-X.....	56
Location-Y.....	56
Foreground Color.....	56
System.....	56
Network Setting.....	58
Account and Password.....	58

Time Setting .....	58
Firmware Update .....	59
Disk Format .....	59
Device Name Setting.....	59
Other Option .....	60
System Control.....	60
<i>Status</i> .....	60
<i>Vertical</i> .....	60
6.3 OPERATIONS.....	61
<i>Video Streaming</i> .....	61
RTSP/TS/HLS.....	61
RTMP .....	66
<i>Text Overlay Video</i> .....	67
6.4 RECORD/STREAM PANEL .....	69
<i>Record Button</i> .....	69
<i>Stream Button</i> .....	69
<i>Bitrate Button</i> .....	70
<i>Vertical Button</i> .....	70
6.5 RESTORING FACTORY DEFAULTS .....	70
6.6 FIRMWARE UPDATE .....	70
<b>CHAPTER 7 APPENDICES .....</b>	<b>71</b>
APPENDIX 1 TALLY OUTPUTS .....	71
APPENDIX 2 FIRMWARE UPGRADE.....	72
<i>Keyboard / Mainboard</i> .....	72
<i>Video Streaming Server</i> .....	74
APPENDIX 3 RECOMMENDED SD CARDS.....	76
APPENDIX 4 FREQUENTLY-ASKED QUESTIONS.....	78
APPENDIX 5 ETHERNET CABLE SELECTION FOR HDBASET NETWORKS .....	79
APPENDIX 6 DIMENSIONS .....	81
APPENDIX 7 SPECIFICATIONS .....	82
<b>SERVICE AND SUPPORT .....</b>	<b>84</b>

### **Disclaimer of Product & Services**

The information offered in this instruction manual is intended as a guide only. At all times, Datavideo Technologies will try to give correct, complete and suitable information. However, Datavideo Technologies cannot exclude that some information in this manual, from time to time, may not be correct or may be incomplete. This manual may contain typing errors, omissions or incorrect information. Datavideo Technologies always recommend that you double check the information in this document for accuracy before making any purchase decision or using the product. Datavideo Technologies is not responsible for any omissions or errors, or for any subsequent loss or damage caused by using the information contained within this manual. Further advice on the content of this manual or on the product can be obtained by contacting your local Datavideo Office or dealer.

## FCC Compliance Statement

This device complies with part 15 of the FCC rules. Operation is subject to the following two conditions:

- (1) This device may not cause harmful interference, and
- (2) This device must accept any interference received, including interference that may cause undesired operation.

## Warnings and Precautions

1. Read all of these warnings and save them for later reference.
2. Follow all warnings and instructions marked on this unit.
3. Unplug this unit from the wall outlet before cleaning. Do not use liquid or aerosol cleaners. Use a damp cloth for cleaning.
4. Do not use this unit in or near water.
5. Do not place this unit on an unstable cart, stand, or table. The unit may fall, causing serious damage.
6. Slots and openings on the cabinet top, back, and bottom are provided for ventilation. To ensure safe and reliable operation of this unit, and to protect it from overheating, do not block or cover these openings. Do not place this unit on a bed, sofa, rug, or similar surface, as the ventilation openings on the bottom of the cabinet will be blocked. This unit should never be placed near or over a heat register or radiator. This unit should not be placed in a built-in installation unless proper ventilation is provided.
7. This product should only be operated from the type of power source indicated on the marking label of the AC adapter. If you are not sure of the type of power available, consult your Datavideo dealer or your local power company.
8. Do not allow anything to rest on the power cord. Do not locate this unit where the power cord will be walked on, rolled over, or otherwise stressed.
9. If an extension cord must be used with this unit, make sure that the total of the ampere ratings on the products plugged into the extension cord do not exceed the extension cord rating.
10. Make sure that the total amperes of all the units that are plugged into a single wall outlet do not exceed 15 amperes.
11. Never push objects of any kind into this unit through the cabinet ventilation slots, as they may touch dangerous voltage points or short out parts that could result in risk of fire or electric shock. Never spill liquid of any kind onto or into this unit.
12. Except as specifically explained elsewhere in this manual, do not attempt to service this product yourself. Opening or removing covers that are marked "Do Not Remove" may expose you to dangerous voltage points or other risks, and will void your warranty. Refer all service issues to qualified service personnel.



13. Unplug this product from the wall outlet and refer to qualified service personnel under the following conditions:
- a. When the power cord is damaged or frayed;
  - b. When liquid has spilled into the unit;
  - c. When the product has been exposed to rain or water;
  - d. When the product does not operate normally under normal operating conditions. Adjust only those controls that are covered by the operating instructions in this manual; improper adjustment of other controls may result in damage to the unit and may often require extensive work by a qualified technician to restore the unit to normal operation;
  - e. When the product has been dropped or the cabinet has been damaged;
  - f. When the product exhibits a distinct change in performance, indicating a need for service.

## Warranty

### ***Standard Warranty***

- Datavideo equipment are guaranteed against any manufacturing defects for one year from the date of purchase.
- The original purchase invoice or other documentary evidence should be supplied at the time of any request for repair under warranty.
- The product warranty period begins on the purchase date. If the purchase date is unknown, the product warranty period begins on the thirtieth day after shipment from a Datavideo office.
- All non-Datavideo manufactured products (product without Datavideo logo) have only one year warranty from the date of purchase.
- Damage caused by accident, misuse, unauthorized repairs, sand, grit or water is not covered under warranty.
- Viruses and malware infections on the computer systems are not covered under warranty.
- Any errors that are caused by unauthorized third-party software installations, which are not required by our computer systems, are not covered under warranty.
- All mail or transportation costs including insurance are at the expense of the owner.
- All other claims of any nature are not covered.
- All accessories including headphones, cables, and batteries are not covered under warranty.
- Warranty only valid in the country or region of purchase.
- Your statutory rights are not affected.

### ***Three Year Warranty***

- All Datavideo products purchased after July 1st, 2017 are qualified for a free two years extension to the standard warranty, providing the product is registered with Datavideo within 30 days of purchase.



- Certain parts with limited lifetime expectancy such as LCD panels, DVD drives, Hard Drive, Solid State Drive, SD Card, USB Thumb Drive, Lighting, Camera module, PCIe Card are covered for 1 year.
- The three-year warranty must be registered on Datavideo's official website or with your local Datavideo office or one of its authorized distributors within 30 days of purchase.

## Disposal

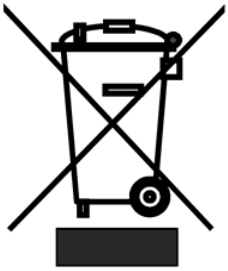

### For EU Customers only - WEEE Marking

This symbol on the product or on its packaging indicates that this product must not be disposed of with your other household waste. Instead, it is your responsibility to dispose of your waste equipment by handing it over to a designated collection point for the recycling of waste electrical and electronic equipment. The separate collection and recycling of your waste equipment at the time of disposal will help to conserve natural resources and ensure that it is

recycled in a manner that protects human health and the environment. For more information about where you can drop off your waste equipment for recycling, please contact your local city office, your household waste disposal service or the shop where you purchased the product.



**CE Marking** is the symbol as shown on the left of this page. The letters "CE" are the abbreviation of French phrase "Conformité Européene" which literally means "European Conformity". The term initially used was "EC Mark" and it was officially replaced by "CE Marking" in the Directive 93/68/EEC in 1993. "CE

Marking" is now used in all EU official documents.

# Chapter 1 Introduction

Datavideo's HS-1600T MKII Hand-carry Mobile Switcher, the cutting-edge technology that supports **Full HD 1080P**, is designed for broadcast of live events and TV programs with a need for mixing a wide variety of video and audio sources. The HS-1600T MKII is a highly valuable solution for **religion, education and AV markets**.

With its built-in **HDBaseT technology**, HS-1600T MKII is able to accept the Full HD 1080p video format from three PTC-150T HDBaseT PTZ Cameras through three individual CAT-6 cables. Each cable runs up to **100 meters**. While shooting in the field, the **PoE** feature serves to power the three PTC-150T devices. The PoE feature can also be used in the field where long-distance transmission is required.

The HS-1600T MKII also features an **audio mixer** with balance XLR inputs and unbalance RCA audio inputs; more features include **PIP, WIPE Generator** and **Tally**.

The HS-1600T MKII has a **Joystick** that allows the user to **Pan, Tilt** and **Zoom** the PTC-150T camera. In addition, the HS-1600T MKII also allows the user to adjust the PTC-150T's **Focus, IRIS** and **other settings**.

HS-1600T MKII also features an easy-to-use video **streaming** and **recording** device for professional video producers who need to simultaneously stream a live event and record the master quality version for post-event editing.

## 1.1 Features

- Full HD 1080P Video Format
- Built-in HDBaseT technology to connect three PTC-150T HDBaseT PTZ Cameras through three CAT-6 (or higher) cables with each cable running up to 100 meters.
- PoE technology to Power the PTC-150Ts
- Joystick Pan, Tilt and Zoom with speed control
- Iris, Focus, and Gain Control as well as other PTC-150T camera functions
- Simultaneous Live Streaming & Recording
- Broadcast quality HD / SD H.264 network streaming over RTMP(S), RTSP, TS, and HLS
- Support different bitrates for recording and streaming
- 4 Video Inputs (RJ-45 x 3 + HDMI x 1)
- 3 Video Outputs (RJ-45 x 1 + HDMI x 2)
- Audio inputs: XLR Analogue x 2 + RCA Analogue (L/R) x 2
- Versatile Mix Effects: PIP, WIPE, Mix and Fades
- Tally Output
- One 17.3-inch monitor with a resolution of 1920x1080



# 1.2 System Diagram

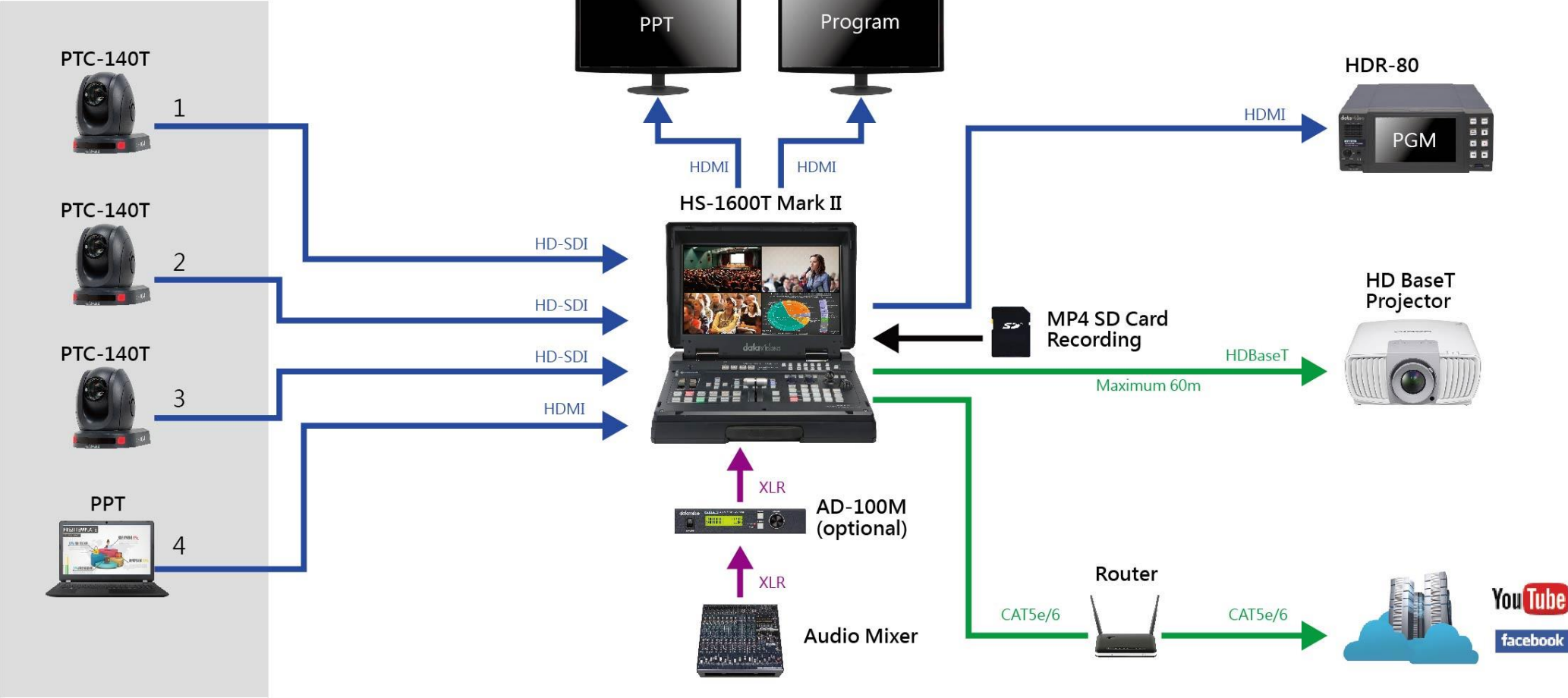

# Chapter 2 Connections and Controls

## 2.1 Rear Panel

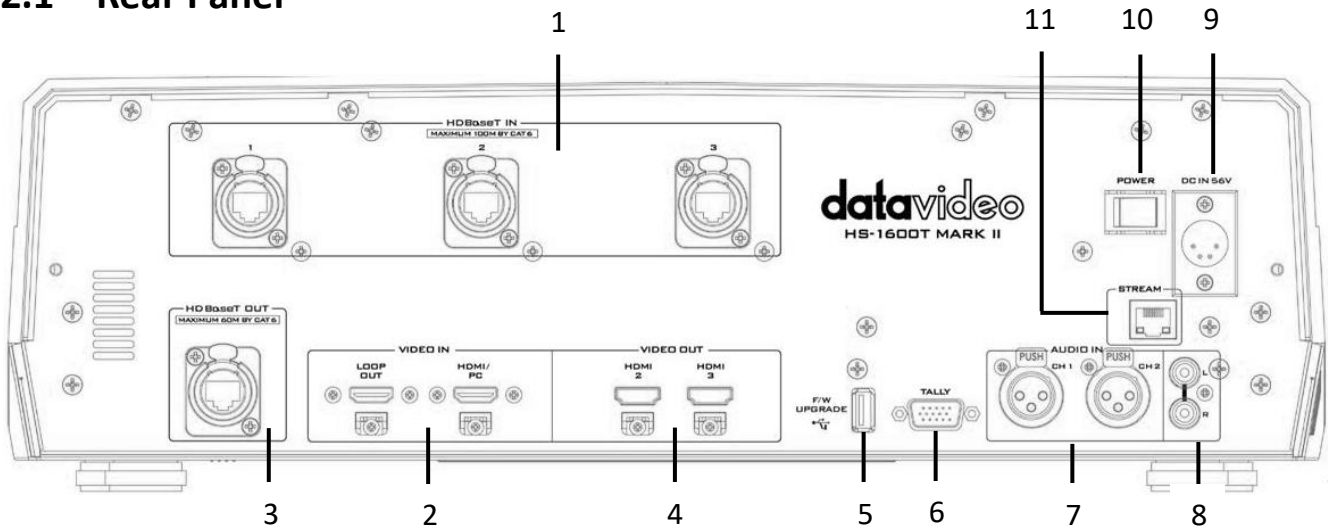

- |   |                      |    |                                    |
|---|----------------------|----|------------------------------------|
| 1 | HDBaseT Port IN x 3  | 7  | AUDIO IN – XLR Balanced CH1/CH2    |
| 2 | HDMI Video IN        | 8  | AUDIO IN – Stereo RCA (Left/Right) |
| 3 | HDBaseT Port OUT x 1 | 9  | DC IN                              |
| 4 | HDMI Video OUT x 2   | 10 | Power Switch                       |
| 5 | USB F/W Upgrade Port | 11 | Stream Port                        |
| 6 | TALLY Output Port    |    |                                    |

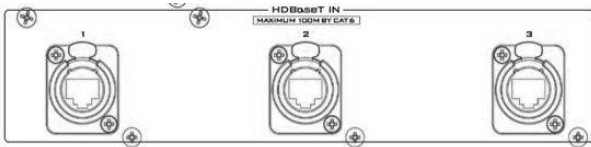

### 1. HDBaseT IN

The HDBaseT ports connect three HDBaseT cameras via three CAT-6 Ethernet cables. Please note that the baud rate is 38400 and cannot be changed by the user. Hence, in order to establish connection with the camera, you will need to set the camera's baud rate to 38400. See [Section 5.2](#) for instructions on setting the baud rate of connected cameras.

If the camera's baud rate is already pre-set to 38400, the camera video should appear on the respective Multiview quadrants as soon as the camera is physically connected to the HDBaseT port (See Multiview Screen below).

In addition to connecting to cameras, the HS-1600T MKII can also receive videos sent from Datavideo's HBT-5 and HBT-10. The highest resolution supported is 1080p60 and the maximum allowable transmission distance is 100 meters. **If you experience any problem while connecting, please contact the local Datavideo sales office or distributors.**



**Note:** The HDBaseT port is designed using Neutrik’s etherCON A series connector system, which is optimized for pro audio and video network applications. Prior to using the HS-1600T MKII, you will need to first acquire the EtherCON A series connector to make your own Ethernet cable. Please visit Neutrik’s official home page (<http://www.neutrik.com/>) for more information.

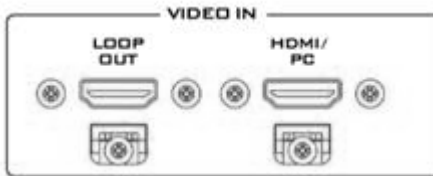

## 2. HDMI Video IN

The **HDMI/PC** Input port allows connection of an additional HDMI video source or a PC and the video or the PC screen will be displayed in the fourth quadrant of the Multiview (built-in monitor). The **Loop OUT** port allows you to connect an additional monitor for displaying the video source connected or the PC screen separately.

### Multiview Screen

<b>HDBaseT IN 1 (CH1)</b>	<b>HDBaseT IN 2 (CH2)</b>
<b>HDBaseT IN 3 (CH4)</b>	<b>HDMI/PC (CH5)</b>

**Note:** Please use program source row buttons to select the Program video source and preview source row buttons to select the Preview video source.



## 3. HDBaseT OUT

The **HDBaseT OUT** port allows you to deliver video directly to HDBaseT devices such as the HBT-11 HDBaseT Receiver Box (Contact your local Datavideo office or visit our official website for more information). Note that the maximum video transmission distance is **60 meters**.

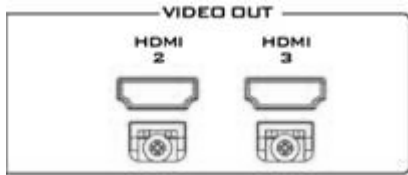

#### 4. HDMI Video OUT 2/3

The HDMI Video Out 2/3 output Program video only. Connect these two ports to HDMI monitors or other HDMI destination devices.



#### 5. USB F/W Upgrade Port

USB port for firmware upgrade. Please refer to the [Firmware Upgrade](#) section for details.

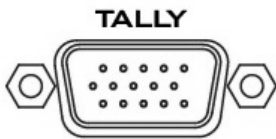

#### 6. TALLY Output Port

Sends **Red** and **Green** tally signals to each channel.

**Red** indicates On-Air, and **Green** indicates next camera source. Tally output port can connect other Datavideo peripheral devices such as ITC-100, ITC-200, AM-100 or other monitor models, allowing the peripheral device to communicate with the HS-1600T MKII or send tally signal to be displayed on the monitor.

See [Appendix 1](#) for physical pin connections and [Section 3.5](#) for [Tally Mode](#) selection.

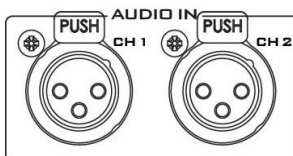

#### 7. Audio Input – XLR Balanced (CH1/CH2)

Two channels of XLR Balanced Audio Input.

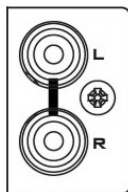

#### 8. Audio Input – Stereo RCA (Left/Right)

Connects unbalanced analog audio source (stereo).

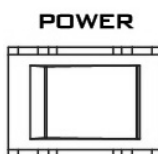

#### 9. Power Switch

Power switch ON/OFF

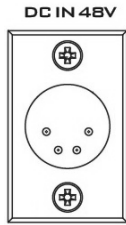

### 10. DC IN

DC in socket connects the supplied 48V / 190W PSU. The connection can be secured by screwing the outer fastening ring of the DC In plug to the socket.

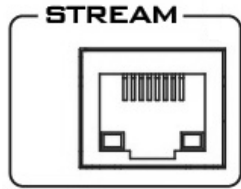

### 11. Stream Port

The stream port allows the user to establish direct connection between the notebook computer and the HS-1600T MKII in order to access the built-in NVS-31 Mark II or connect the NVS-31 Mark II to any local area network.

**Note:** See the [Chapter 6 Video Streaming](#) for device configuration and operations.

## 2.2 Switcher Keyboard Panel

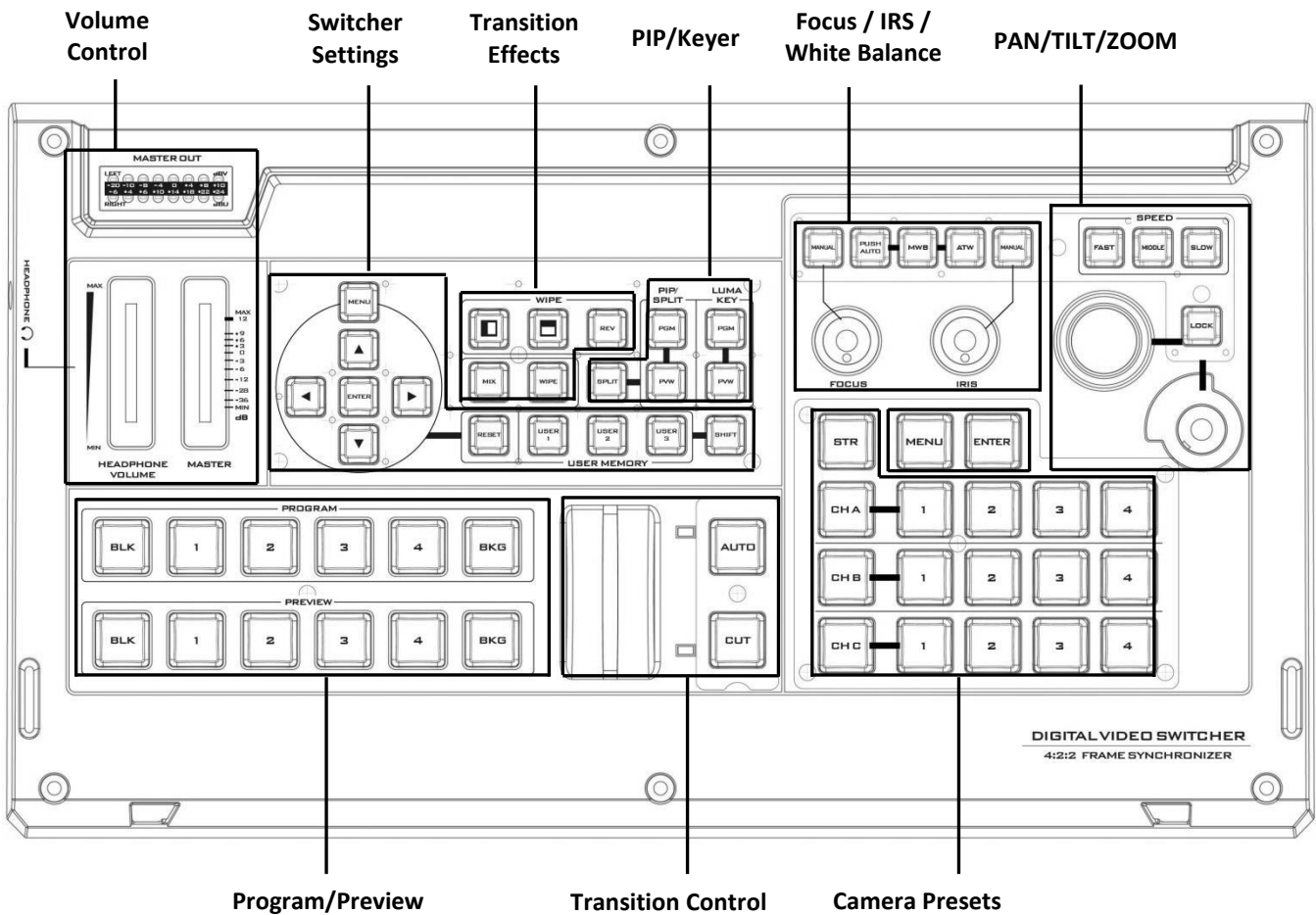

Switcher Settings	Volume Control
Menu browsing buttons RESET button User Memory Shift button	Volume adjustment sliders Headphone jack Audio meter Headphone volume control knob
Transition Effects	Camera Presets
WIPE transition effect selection MIX Enable/Disable button WIPE transition effect Enable/Disable	Channel Selection Buttons Preset Buttons STR Button
PIP/Keyer	FOCUS / IRIS / White Balance
Enable/Disable buttons for PIP Keyer Luma Keyer Enable/Disable buttons Split Activation button	Focus Adjustment IRIS Adjustment White Balance
Transition Control	PAN / TILT / ZOOM
T-Bar (manual transition) CUT button AUTO transition button	Speed Selection Buttons Joystick – PAN/TILT VR Knob – ZOOM LOCK Button
Program/Preview	Camera MENU Control
Program row Preview row	MENU Button ENTER Button

### Switcher Settings

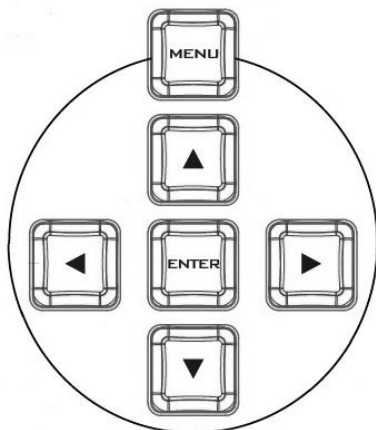

#### Menu browsing buttons

Press the **MENU** button to gain access to the menu; use the up/down/left/right **arrow buttons** to browse through the menu and press **ENTER** button to select an option or **MENU** button again to exit.

#### Reset Button

**Mode 1** – When in Menu Select mode (left hand column of the OSD menu), pressing the 'Reset' button will reset all current menu items to their factory defaults.

**Mode 2** – When in a Sub-Menu, pressing the 'Reset' button will reset the current menu line only.



### User Memory

User Memory buttons 1-3 allow the user to quickly recall and load previously saved switcher settings with a single button press. This includes PIP and Keyer settings. See the [User Memory](#) section for setup information.



### Shift Button

Pressing the **Shift** button will switch **USER 1-3** buttons to **USER 4-6** buttons

## Transition Effects

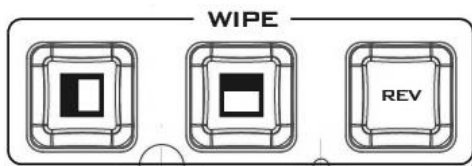

### WIPE Transition Effect Selection

Each Wipe button consists of black and white colors. The white represents the current **Program** image and the black represents the **WIPE-IN** image. The HS-1600T MKII provides 3 WIPE presets with the **Horizontal** and **Vertical** WIPEs selectable on the control panel. The **Center** WIPE can be selected from the menu ([Start](#)).

Pressing the **REV** button reverses the direction of the **WIPE**.



### MIX Enable/Disable Button

A **MIX**, also known as a dissolve, is a transition wherein the Program video is replaced by the Preview video at a smooth rate, and at the same time. Pressing the **MIX** button enables the **MIX** transition effect and automatically disables the **WIPE** button. To trigger the **MIX** effect, simply press the **AUTO** button or move the **T-Bar**.



### WIPE Transition Effect Enable/Disable Button

Pressing the **WIPE** button enables the **WIPE** transition effect after which the **WIPE** transition effect can be selected. To trigger the **WIPE** transition effect, simply press the **AUTO** button or move the **T-Bar**.

**Wipe Transition Effect, Border and Position** settings can be found in the OSD menu ([Start](#)).

## PIP / Keyer

### PIP/ SPLIT

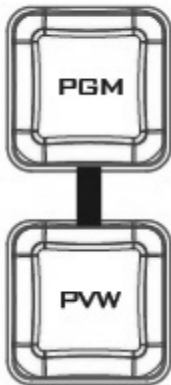

#### Enable/Disable Buttons for PIP Keyer

Picture in Picture puts the selected Sub Video Source in a window on the Main Program view, with control over window size and placement. For PIP configuration, please refer to the [PIP](#) section.

**PIP PGM:** Shows the configured PIP on the PGM output after transition, however, the PIP cannot be previewed on the QUAD split view display.

**PIP PVW:** Sets the configured PIP on the next transition. Holding down this button allows selection of the PIP source from the Preview Source row. The selected source button will flash.

### LUMA KEY

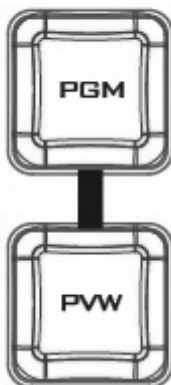

#### Luma Keyer Enable/Disable Buttons

**Luma Key PGM:** Shows the luma key source on the PGM output and enables the luma key effect, however, the luma key effect cannot be previewed on the QUAD split view display.

**Luma Key PVW:** Enables luma key source for the PGM output on the next transition. Holding down this button allows selection of the luma key source from the Preview Source row. The selected source button will flash.

See [Section 3.4](#), the [Luma Key](#) section, for luma key configurations.



#### Split Activation Button

**After activating the PIP window**, pressing the **Split** button will split the PROGRAM output display into two with the program out view on the left and the PIP view on the right.

To select the Split source, i.e. the program out view, please see [Split Source](#) in [Section 3.2](#).



## Transition Control

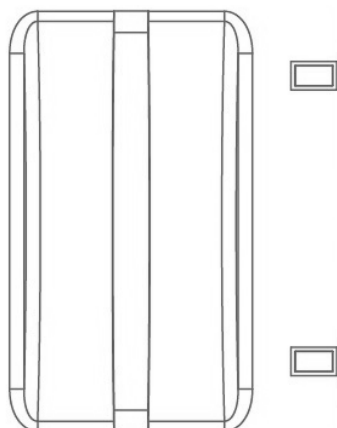

### T-Bar (Manual Transition)

**T-Bar** is used for manual transition. The **T-Bar** can be either all the way up, all the way down or anywhere in between. When the T-Bar is pushed to halfway between the topmost position and the bottommost position, the keyboard functions will be disabled.

**PVW** and **PGM** views can be transitioned at your preferred speed. To include the transition effect, simply press the **WIPE** or **MIX** button, after which the **Transition Effect** will be triggered as you move the **T-Bar**.



### CUT Button

Pressing the **Cut** button performs immediate manual switch between PVW and PGM views without the transition effect.



### AUTO Button

Pressing the **Auto** button automatically transitions **PVW** and **PGM** views according to the selected speed and the configured transition effect.

## Program Output

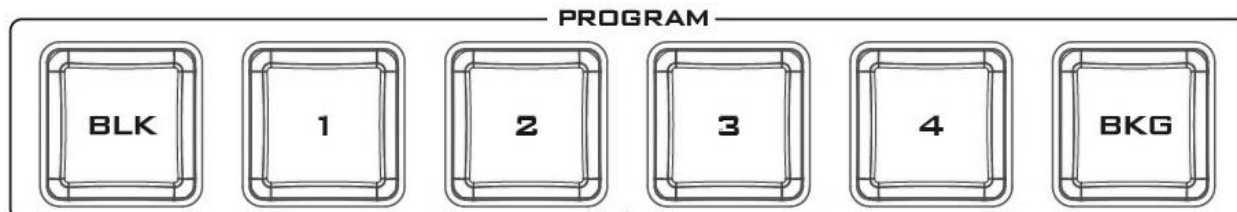

### Program Source Row

Pressing the number buttons along the **PROGRAM** row selects the Program video source.

**BKG** button: Pressing the **BKG** button will switch the background to a **Matte** background. The BKG color can be configured on the OSD MENU ([Start](#) → [BKG Color](#)). The available color options are listed as follows:

- White
- Yellow
- Cyan
- Green
- Magenta
- Red
- Blue
- Black

**BLK** button: Pressing the **BLK** button places a black screen on the **PROGRAM** view.

## Preview Output

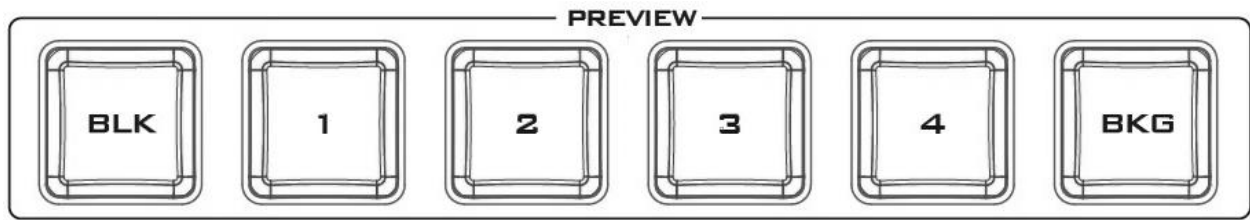

### Preview Source Row

Pressing the number buttons along the **PREVIEW** row selects the Preview video source.

**BKG** button: Pressing the **BKG** button will set the Preview OUT to a **Matte** background, which will be displayed on the **Program OUT** monitor upon the next transition. The BKG color can be configured on the OSD MENU ([Start](#) → [BKG Color](#)). The available color options are listed as follows:

- White
- Yellow
- Cyan
- Green
- Magenta
- Red
- Blue
- Black

**BLK** button: Pressing the **BLK** button sets the **Preview** OUT to a black screen.

## Volume Control

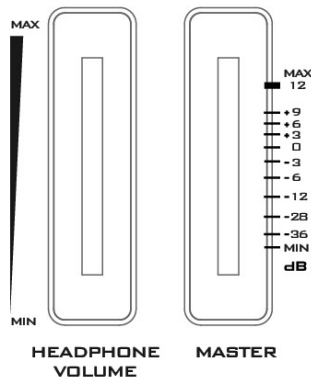

### Volume Adjustment Sliders

Sliders to control audio levels for the Main audio mixer.

**Headphone Volume:** Audio volume of the connected headphone.

**Master:** Main audio output volume.



### Headphone Jack

Headphone jack accepts the mini jack plug of the stereo headphone type. The headphone volume is controlled by the Headphone volume adjustment slider.

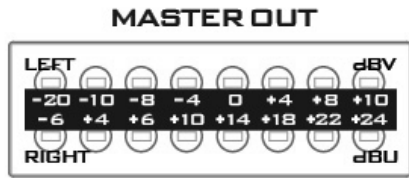

### MASTER OUT Meter

The LED style meters show the audio signal strength at the Main Program Audio Output. The signal strength is determined by the level set with the Master OUT slider. The LEDs turn red at +10 dB to indicate clipping distortion.

Audio Volume (dBV)	-20		-10		-8		-4		0		+4		+8		+10	
LED Color	G		G		G		G		G		Y		Y		R	
Range (dBV)	-20	-12	-11	-9.5	-8.5	-6.5	-5.5	-3	-2	1	2	5.5	6.5	8	9+	

G: Green Y: Yellow R: Red

## Camera Presets



### Channel Selection Buttons

To control or set up a connected camera, first select it by pressing these buttons. The selected channel button will be turned ON.

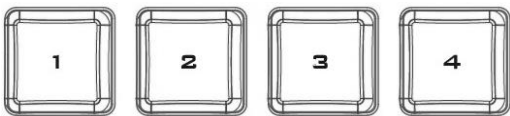

### Preset Buttons

These buttons may be used to store up to four camera positions for each camera. Each button corresponds to one stored camera position. The button LED will be turned ON when selected.



### STR Button

Pressing this button enters the HS-1600T MKII into **STORE MODE**. When activated, this allows the current camera position to be stored in a chosen Channel Preset Button by pressing the corresponding preset button.

Press again to exit **STORE MODE**.

## FOCUS / IRIS / White Balance

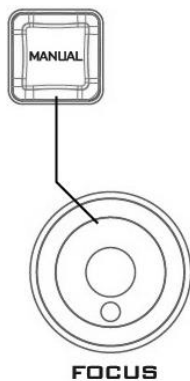

### Focus Adjustment

To manually control the **FOCUS** setting, first press the **MANUAL** button to enter the manual mode. The button LED will be turned ON to indicate that the manual mode is enabled.

The **FOCUS** dial can then be rotated to set the focus.

If the **MANUAL** button is disabled (OFF), the camera is in **AUTO FOCUS** mode.

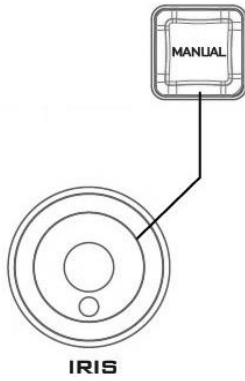

### IRIS Adjustment

To manually control the **IRIS** setting, first press the **MANUAL** button to enter the manual mode. The button LED will be turned ON to indicate that the manual mode is enabled.

The **IRIS** dial can then be rotated to set the exposure.

If the **MANUAL** button is disabled (OFF), the camera is in **AUTO IRIS** mode.

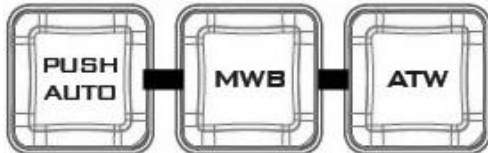

### White Balance

Certain light conditions can cause discoloration of your image. White balance allows you to adjust the color balance in order to produce the best image quality.

#### Push Auto

The One Push White Balance mode is a fixed white balance mode that is automatically adjusted at the user's request. The One Push White Balance data is lost when the power is turned off, in other words, turning off the machine power resets the One Push White Balance setting.

The One Push White Balance mode can also be used for white balance calibration. Zoom in the camera lens on a white piece of paper which basically serves as a reference for what is white, then press the PUSH AUTO button to balance other colors accordingly.

**Note: If you are using the HS-1600T MKII in conjunction with the PTC-140T, after the PUSH AUTO key is pushed, wait for 5 to 6 seconds while the camera adjusts the white balance setting automatically then proceed to the next action.**

#### MWB (Manual White Balance)

Push to enable manual white balance adjustment.

#### ATW (Automatic White Balance)

Push to enable automatic white balance adjustment.

## PAN / TILT / ZOOM

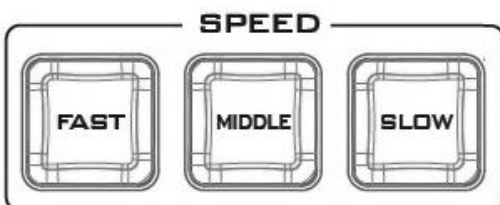

### Speed Selection Buttons

The speed at which the selected camera moves can be chosen by pressing one of the three speed buttons.

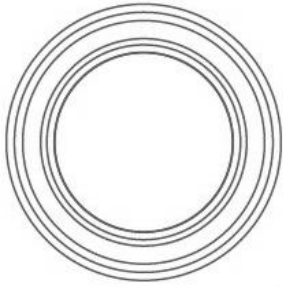

### Joystick – PAN / TILT

**PAN** – Move the joystick left or right to pan the selected PTZ camera from left to right or vice versa.

**TILT** – Move the joystick up or down to tilt the selected PTZ camera up or down.

**Note:** Before attempting to use the joystick to PAN or TILT a selected camera, first make sure the **LOCK** button is not enabled. If the **LOCK** button LED is ON, the joystick is locked; press the **LOCK** button to unlock the joystick.

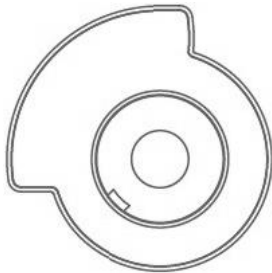

### VR Knob – ZOOM

**ZOOM** – Twist the joystick clockwise (to the right) or anti-clockwise (to the left) to have the selected PTZ camera zoom in or out.

Note: Make sure the **LOCK** button is not enabled. If the **LOCK** button LED is ON, the joystick is locked; press the **LOCK** button to unlock the joystick.



### LOCK Button

When enabled, the joystick will be in the lock state. To resume its functional status, simply press the button once to unlock the joystick.

## Camera MENU Control



### MENU Button

Press once to open the **OSD MENU** of the connected PTC-150T on the monitor screen. Use the **P/T** joystick to move between options. To select, simply press the **ENTER** button. Please see the **PTC-150T instruction manual** for details of the menu operation.

**Note:** Pressing the menu button again will not exit the **OSD MENU**. Select the **ESCAPE** option on the **OSD MENU** to exit.



### ENTER Button

Press this button to select a menu option after the camera OSD menu is opened.

## 2.3 Monitor Control Panel

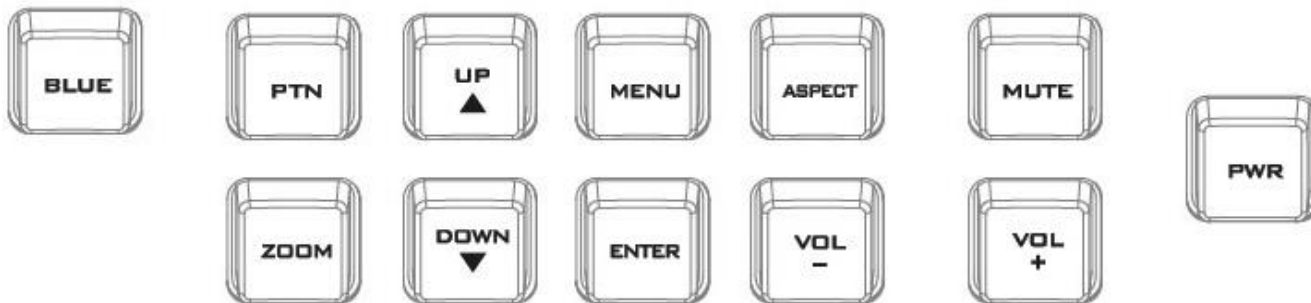

### Power

Switches the HS-1600T MKII Monitor Power ON / OFF



### BLUE

Press this button to eliminate the red and green component of input signals. Only the blue component of an input is displayed on the screen. This allows adjustments of chroma and phase. (Phase adjustment is effective with NTSC signals).



### PTN

Press to display internally generated SMPTE 75% Colour Bars. Press again to return to the previously selected video input.



### ZOOM

This feature is designed for use with HD-SDI and HDMI sources above 720p resolution. Press this button to zoom in to the video on the display. This is strictly a zooming function and does not alter the native aspect ratio of the source pixels to fill the screen.

The **ZOOM** button allows you to toggle the Pixel Zoom feature between **zoom x1, x2, x4** and **x8**.

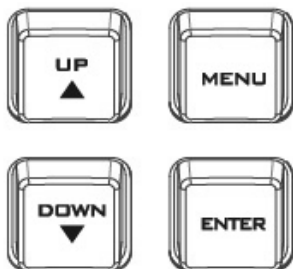

### Menu Navigation Buttons

Display and navigate the setup menus. See [Monitor Menu Options](#) for more details.



**Aspect Ratio Button**  
Sets the Aspect Ratio to 16:9 / 4:3

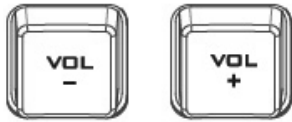

**Volume Control**  
Adjusts the speaker / headphone volume up / down.

**MUTE**  
Mutes the audio from the internal speakers or headphone socket.

## 2.4 Record/Stream Panel

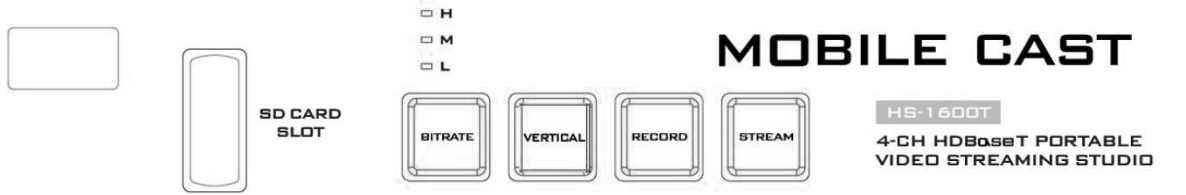

**RECORD**  
Press the **RECORD** button to start enable video record mode. See [Section 6.4](#) for details.



**STREAM**  
Press the **STREAM** button to enable video stream mode. See [Section 6.4](#) for details.



**Vertical Button**  
Press the **Vertical** button to switch video orientation of the four input videos (HDBaseT 1-3 and HDMI/PC) between **Portrait** and **Landscape**. See [Section 6.4](#) for details. **Note: You can also switch video orientation via web user interface; see descriptions of the [Vertical](#) page for details.**



**BITRATE**  
Use the **BITRATE** button to switch between **high (H)**, **moderate (M)** and **low (L)** bitrates for each of the **RECORD**, **STREAM** and **RECORD+STREAM** buttons. See [Section 6.4](#) for details.

**Note: Not all models come with the bitrate button.**



### **SD Card Slot**

Insert an SD card into the SD card slot for video recording.

**Note that you should only use Class 10 SD card or above. See the Appendix, [Recommended SD Cards](#), for a list of SD cards recommended by Datavideo.**

**Note: Do not remove SD card while it is being written as doing so may result in corrupted video files.**



## Chapter 3 Switcher OSD Menu

The switcher's OSD menu allows the user to perform several configurations of video effects, such as picture-in-picture, luma key and etc. The user can also configure the audio settings in the Audio menu. In the setup menu, the user is allowed to set video output resolution, reset to factory default, and selects the interface language.

### 3.1 Start

Main	Sub-Menu	Options or Values	Default Value
Start	Transition Type	MIX WIPE	Mix
	Transition Speed	1-200 frames	60 frames; the duration in second depends on the Program OUT resolution.
	WIPE Effect	1. Horizontal 2. Vertical 3. Center	1
	WIPE Border Size	OFF Small Middle Large	Small
	WIPE Border Color	White Yellow Cyan Green Magenta Red Blue Black	Red
	BKG Color	White Yellow Cyan Green Magenta Red Blue Black	White

#### Transition Type

The HS-1600T MKII provides two types of transition effect, which are cross dissolve (MIX) and WIPE. The default setting is **MIX**.

#### Transition Speed

The **Transition Speed** allows the user to set the **MIX** or **WIPE** effect duration, in frames. If the **Transition Speed** is set to a value of 60 then the transition will take effect over a period of 1 second if the progressive video is chosen and 2 seconds if the interlaced video is chosen. When the **AUTO** button is pressed, the transition will take the current **Transition Speed** defined by the user.

**Note:** Pressing the up or down arrow button on the control panel allows the user to either increment or decrement the transition speed by 1. To change the value at an accelerated rate, simply press and hold the left or right arrow button.

### Wipe Effect

On the HS-1600T MKII, there are three wipe effects available for the user to choose. The three wipe effects are **HORIZONTAL**, **VERTICAL** and **CENTER**. The default is Horizontal.

### WIPE Border Size

The **WIPE Border Size** generally allows the user to select an appropriate border width. Setting the **WIPE Border Size** to OFF turns the border off. Setting the border size to small selects a thin border; middle will yield a medium size width; large is the maximum wipe border width.

### WIPE Border Color

In this option, you will be allowed to select a color for your wipe border. The available colors are listed as follows:

- White
- Yellow
- Cyan
- Green
- Magenta
- Red
- Blue
- Black

### BKG Color

In this option, you will be allowed to assign a color to the **BKG** button. The available colors are listed as follows:

- White
- Yellow
- Cyan
- Green
- Magenta
- Red
- Blue
- Black

## 3.2 PIP / Split

Picture-In-Picture (P-In-P) places a sub window on the **PGM** or **Multiview** screen. You can configure various settings of the PIP window in the **PIP/Split** sub menu.

**Note:** When **PIP** and **Lumakey** features are enabled at the same time, the lumakey source will be the upper layer and the PIP source will be the lower layer. The layer order cannot be changed.

Main	Sub-Menu	Options or Values	Default Value
PIP/Split	PIP Source	Black Input 1 Input 2 Input 3 <b>Input 4*</b>	Input 2

Main	Sub-Menu	Options or Values	Default Value
		Background Color Bar	
	PIP Size	1-100%	30%
	Position X	-50% - +50%	20%
	Position Y	-50% - +50%	10%
	Split Source	Black Input 1 Input 2 Input 3 <b>Input 4*</b> Background Color Bar	Input 2
	Border Size	OFF Small Middle Large	Small
	Border Color	White Yellow Cyan Green Magenta Red Blue Black	Red

### PIP Source

In this option, the user will be allowed to assign the PIP source; the available sources are listed as follows:

- Black
- Input 1
- Input 2
- Input 3
- **Input 4\***
- Background
- Color Bar

**Tip: To quickly assign the PIP source, simply press and hold the PIP PGM button and then select a source from the Program BUS.**

### PIP Size (PIP Window Size)

The PIP window size ranges from 1 to 100 with 1% being the smallest and 100 being the largest. Therefore 50% would represent a PIP window which is half the size of the background image. 100% would see the PIP window totally cover the background image unless offset to one side.

### Position X

Adjusting **Position X** moves the PIP window horizontally. Pressing the up or down arrow button on the control panel allows the user to either decrement or increment **Position X** by 1. To change the value at an accelerated rate, simply press and hold the up or down arrow button.

## Position Y

Adjusting **Position Y** moves the PIP window vertically. Pressing the up or down arrow button allows the user to either increment or decrement **Position Y** by 10. Press and hold the up or down arrow buttons to change the value at an accelerated rate.

## Split Source

**After the PIP window is activated**, pressing the Split button will split the PROGRAM output display into two with the program out view on the left and the PIP view on the right. The Split source, i.e. the program out view, can be selected in this option. The available split sources are listed as follows:

- Black
- Input 1
- Input 2
- Input 3
- **Input 4\***
- Background
- Color Bar

## Border Size

The **Border Size** generally allows the user to select an appropriate PIP border width. Setting the **Border Size** to OFF turns the PIP border off. Setting the border size to small selects a thin border; middle will yield a medium size width; large is the maximum PIP border width.

## Border Color

The user is allowed to assign a PIP border color. The available colors are listed as follows:

- White
- Yellow
- Cyan
- Green
- Magenta
- Red
- Blue
- Black

*\*Note: Select Input 4 if you would like to use the video source connected to the HDMI input.*

## 3.3 PIP Crop

The PIP Crop basically adjusts the PIP window borders. You can adjust each side individually (Left / Right / Top / Bottom) or all four sides at the same time (Size).

Main	Sub-Menu	Options or Values	Default Value
PIP Crop	Size	0 – 100%	0
	Left	0 – 100%	0
	Right	0 – 100%	0
	Top	0 – 100%	0
	Bottom	0 – 100%	0

The PIP Crop sub-menu options are described below:

- **Left** – Adjusts the position of the left edge of the PIP window.

- **Right** – Adjusts the position of the right edge of the PIP window.
- **Size** – Adjusts the PIP image crop size.
- **Top** – Adjusts the position of the top edge of the PIP window.
- **Bot** – Adjusts the position of the bottom edge of the PIP window.

### 3.4 Lumakey

Keyer of the HS-1600T MKII provides the user with the capability of luma keying.

**Note: When PIP and Lumakey features are enabled at the same time, the lumakey source will be the upper layer and the PIP source will be the lower layer. The layer order cannot be changed.**

Main	Sub-Menu	Options or Values	Default Value
Lumakey	Lumakey Source	Black Input 1 Input 2 Input 3 <b>Input 4*</b> Background Color Bar	Input 2
	Mode	Black White	Black
	Cleanup Level	0 – 100	20
	Transparency	0 – 64	64

#### Lumakey Source

Lumakey source is where you can select the image for luma keying. The available sources are listed as follows:

- Black
- Input 1
- Input 2
- Input 3
- **Input 4\***
- Background
- Color Bar

#### Mode

There are two modes available on the Luma Keyer. Select Black if the image is on a black background and white if the image is on a white background.

#### Cleanup Level

The **Cleanup Level** allows the user to fine tune the effect of the luma key. The default value is 20.

#### Transparency

In this option, you will be able to adjust the transparency of the overall foreground key image.

**\*Note: Select Input 4 if you would like to use the video source connected to the HDMI input.**

## 3.5 Audio

This option allows the user to configure various audio settings such as muting HDMI output audio, set the audio type, selecting your tally type and etc.

Main	Sub-Menu	Options or Values	Default Value
Audio	Mute	OFF/ON	Off
	HDMI Input	Input 1-4 / Follow	Follow
	HDMI Group	Channel 1/2 Channel 3/4 Channel 5/6 Channel 7/8	Channel 1/2
	Level	Auto / SMPTE / EBU	Auto
	Tally Mode	Normal / Audio Mixer	Normal

### Mute

The **Mute** allows you to turn ON/OFF the embedded audio component at the **HDMI-in**. The default is OFF.

### HDMI Input

In this option, you can select the audio source. Selection of input 1-4 allows the HS-1600T MKII to play the enabled audio source. If “**Follow**” is selected, the audio will enter Audio follow Video mode, i.e. playback of the audio of the output video.

### HDMI Group

The HDMI Group allows the user to assign the HDMI audio channel. The default audio channel pair is Channel 1/2. You can select any of the four audio channel pairs.

### Level

There are two different audio standards available for selection. The user can either select the EBU or SMPTE standard. By selecting AUTO allows the device to automatically detect the audio standard. When the image is 50 Hz, the audio follows EBU standard and when the image is 59.94/60 Hz, the audio follows SMPTE standard.

### Tally Mode

Tally output port generally sends two tally signals to each channel. In Datavideo products, **Red** indicates On-Air, and **Green** indicates next camera source.

The HS-1600T MKII provides **two tally modes**:

**Normal:** If in normal mode, tally lights of all camera sources displayed on the PGM monitor will be turned ON (Red). These sources include PGM, PIP and Key sources. While the transition is in progress, as the next video seen on the PGM monitor, tally light of the PVW source camera will then also be turned ON (**Red**).

**Audio Mixer:** If the Audio Mixer mode is selected, only tally light of the PGM source camera selected on the keyboard panel will be turned ON (Red). While the transition is in progress, the tally light color will remain unchanged. The tally light color will only change (red → green) after the transition of PGM and PVW views is complete.

### 3.6 User Mems

In “**User Mems**”, the user is allowed to **load** previously saved settings and **save** the currently configured settings.

Main	Sub-Menu	Options or Values	Default Value
User Mems	Load Memory	User 1-6	
	Load		
	Save Memory	User 1-6	
	Save		
	Factory Default	[Reset]	

#### Load Memory

Use the up/down arrow to select the desired memory location and load the saved setting by selecting “**Load**”.

**Tip:** The user can also press one of the USER memory shortcut buttons (1-3) on the control panel as a quick way of loading those previously saved User configurations. Use the **SHIFT** button to switch between **USER MEMORY 1-3** and **USER MEMORY 4-6**.

#### Save Memory

Use the up/down arrow to select the desired memory location and save the current setting by selecting “**Save**”.

#### Factory Default

**Reset:** Once selected, the factory default settings will be restored. The device will start the factory reset process in 2 to 3 seconds after “**Reset**” is selected.

### 3.7 Setup

In the “**Setup**” menu, the user can change the **output resolution**, reset the HS-1600T MKII to its **Factory Default** values, choose the preferred OSD menu **language**, **upgrade firmware** and view the **current firmware versions** (Mainboard and Keyboard).

Main	Sub-Menu	Options or Values	Default Value
Setup	PGM Out Res.	1080p/60 1080p/59.94 1080p/50 1080p/30 1080p/25 1080i/60 1080i/59.94 1080i/50 720p/60 720p/59.94 720p/50 576i 480i	
	MV Out Res.	1080p/60 1080p/59.94 1080p/50	

Main	Sub-Menu	Options or Values	Default Value
		1080p/30 1080p/25 1080i/60 1080i/59.94 1080i/50 720p/60 720p/59.94 720p/50	
	Output Format	RGB YUV444 YUV422	
	Save Setup	[Save]	
	Language	English Simplified Chinese Traditional Chinese	
	MB Software	Version	
	KBD Software	Version	

### PGM Out Res.

In **PGM Out RES.**, the user is allowed to select an appropriate **PROGRAM** output resolution. The available resolutions are listed as follows:

- 1080p/60
- 1080p/59.94
- 1080p/50
- 1080p/30
- 1080p/25
- 1080i/60
- 1080i/59.94
- 1080i/50
- 720p/60
- 720p/59.94
- 720p/50
- 576i
- 480i

Once done, simply go to “**Save Setup**” to confirm the selected output resolution.

**Note: Please make sure input and output resolutions are identical to avoid unexpected errors.**

### MV Out Res.

In **MV Out RES.**, the user is allowed to select an appropriate **MULTIVIEW** output resolution. The available resolutions are listed as follows:

- 1080p/60
- 1080p/59.94
- 1080p/50
- 1080p/30
- 1080p/25



- 1080i/60
- 1080i/59.94
- 1080i/50
- 720p/60
- 720p/59.94
- 720p/50

Once done, simply go to “**Save Setup**” to confirm the selected output resolution.

**Note: The new resolution will be effective once selected. If you have selected a resolution that is not supported by the monitor, you will not be able to view the OSD menu. In this case, reboot your machine to restore the resolution previously configured.**

### Output Format

Select a color encoding system for your video output. The available color formats are listed below:

- RGB
- YUV444
- YUV422

### Save Setup

In this option, select “**Save**” to save the current configuration.

### Language

The available OSD menu languages are **English**, **Traditional Chinese** and **Simplified Chinese**.

### MB and KBD Software

The **MB** and **KBD** software fields display the respective version numbers.

## 3.8 Camera

In the “**Camera**” menu, the user will be able to change the camera name, view camera information and perform some basic camera settings. The basic camera settings include the video format, mirror mode, PAN/TILT direction and etc.

Main	Sub-Menu	Options	Values	
Camera	Camera CH. Setup	Yes/No		
	[PTC-150T-01/02/03]	Camera Info	Vendor ID	
			MB Version	
			FPGA Version	
			Motor Version	
			DVIP Version	
	Video	Video Format	1080i/60	
			1080i/50	
			1080p/29.97	
			1080p/25	
		720p/59.94		
		720p/50		
		1080p/59.94		
		1080p/50		
		Mirror Mode	Off	

Main	Sub-Menu	Options	Values
			V H H+V
		Joystick Pan	Normal Reverse
		Joystick Tilt	Normal Reverse
		Memory Speed	1-18
	Operator	Power	On/Standby
		R-Gain	0-255
		B-Gain	0-255
		Tally LED	Off Red Green

### Camera CH. Setup

By selecting Yes/No, you will be able to enable/disable the camera setup.

### PTC-150T-01/02/03

The PTC-150T-01/02/03 options will allow you to configure basic settings of the respective cameras.

#### Camera Info

This field provides camera information display such as **Vendor ID**, **MB Version**, **FPGA Version**, **Motor Version** and **DVIP Version**.

#### Video

In the "Video" sub-option, you will be able to configure the **Video Format**, **Mirror Mode**, **Joystick Direction** and **Joystick Speed**.

The available resolutions in **Video Format** are listed as follows:

- 1080i/60/50
- 1080p/59.94/50/29.97/25
- 720p/59.94/50

In "**Mirror Mode**", there are three types of modes available:

- V: Vertical mirroring
- H: Horizontal mirroring
- H+V: Horizontal and Vertical mirroring

In **Joystick Pan/Tilt**, you can either select the normal PAN/TILT direction or reverse the PAN/TILT direction. The PAN/TILT speed can be configured in **Memory Speed**, which ranges from 1-18.

#### Operator

The **Operator** sub-option offers the user basic camera operation functions, which are described below:

**Power:** Select **ON** to start powering the selected camera; select **Standby** to enter the camera into power standby mode.

**R-Gain/B-Gain:** The red and blue components can be adjusted, ranging from 0 to 255.

**Tally LED:** You can either turn the tally light off or enable the red or green tally light.

## Chapter 4 Monitor



The HS-1600T MKII's built-in monitor can be configured via an on screen menu. Press the **MENU** button to display the Main Menu list on the monitor.



This section covers the Menu options in the order that they appear on the monitor. These settings may also appear in more detail elsewhere in this instruction manual. Options may vary depending on the firmware version in use.

Once the chosen setting has been confirmed with the **ENTER** button, it is stored within the switcher's non-volatile memory.

### 4.1 MENU Options

Main Options	Sub Options	Values	Values
MAIN ADJUST	BRIGHTNESS	0~100	
	CONTRAST	0~100	
	SHARPNESS	0~100	
	SATURATION	0~100	
	TINT	0~100	
	BACKLIGHT	0~100	
	NR	HIGH / MID / LOW / OFF	
	DLC	ENABLE / DISABLE	
	VOLUME	0~100	
	EXIT		
COLOR	6500		
	9300		
	7500		
	USER COLOR	RED	0~100
		GREEN	0~100
		BLUE	0~100
EXIT			
SCAN SETTING	UNDER SCAN	Full Image	
	OVER SCAN	Cropped Image	
INFORMATION	H. FREQUENCY		
	V. FREQUENCY		
	RESOLUTION		
	VER.		
LANGUAGE	English [default]		
	Francis		
	Deutsch		
	Español		
	Italiano		
	Dutch		
	Português		
	Russian		
EXIT			

Main Options	Sub Options	Values	Values
SPECIAL FUNCTION	OSD TIMEOUT	5-120 SEC	
	FRAME RATIO	80 / 90 / OFF	
	4:3 MARK LINE	ON / OFF	
	CENTRAL MARK	ON / OFF	
	CINEMA ZONE MARK	ON / OFF	
	AUDIO CHANNEL L*		
	AUDIO CHANNEL R*		
	EXIT		
FACTORY RESET			
EXIT			

\* Selectable on PGM only; external HDMI and MV are allowed on 1 and 2 ONLY.

## MAIN ADJUST

After pressing the **MENU** button on the monitor control panel, the first menu option highlighted is the **MAIN ADJUST** option.

Press **ENTER** to access the **MAIN ADJUST** Menu and the **Brightness** option will be highlighted.

To adjust the **Brightness**, press **Enter** again. Use the **Up / Down** buttons to change the value and then press **Enter** to store the new value and return to the main menu.

To configure other settings such as **Contrast**, **Saturation**, **Sharpness**, **TINT** and etc, use the **Up / Down** buttons to select the desired option. Follow the above procedure to set the new value.

## COLOR

Press **ENTER** to access the **COLOR** menu and the first option will be highlighted.

Press **ENTER** to select the first color option.

Use the **Up / Down** buttons to navigate the available color options listed as follows.

- **7500**
- **9300**
- **6500**
- **USER COLOR**

## Information

The **System Information** displays **Horizontal Frequency**, **Vertical Frequency**, **Resolution** and the Firmware Version (**Ver.**) of the monitor.

Once selected, the information below will be displayed.

- **H. FREQUENCY:** 33.7KHZ
- **V. FREQUENCY:** 60.0HZ
- **RESOLUTION:** 1920X1080I
- **VER.:** 0.11

## Special Function

In the **Special Function**, you will be able to configure **OSD TIMEOUT**, **Frame Ratio**, **4:3 MARK LINE**, **Central Mark**, **Cinema Zone Mark** and **Audio Channel L & R**.

Use the **Up / Down** buttons to navigate the available options listed as follows. Press **ENTER** to access a particular option.

<b>OSD TIMEOUT</b>	5-120 SEC
<b>FRAME RATIO</b>	90 / 80 / OFF
<b>4:3 MARK LINE</b>	ON / OFF
<b>CENTRAL MARK</b>	ON / OFF
<b>CINEMA ZONE MARK</b>	ON / OFF
<b>AUDIO CHANNEL L*</b>	1/2/3/4
<b>AUDIO CHANNEL R*</b>	1/2/3/4

## Factory Reset

The monitor menu offers a **Factory Reset** option, which will return all the monitor settings to the factory defaults

To reset the monitor, press the **MENU** button and then use the **UP / Down** buttons to navigate to the **FACTORY RESET** option. Press **ENTER** again to reset the monitor. After a few seconds, the monitor settings will return to factory defaults.

## Chapter 5 Applications

### 5.1 Placing a logo on the video using the lumakey function

The HS-1600T MKII allows the user to place a logo on the video using the lumakey function. First of all, create a 1920x1080 (16:9) logo against a black or white background on a laptop. Once the logo is created, please follow the steps outlined as follows to insert the logo layer.

**Note: If your logo consists primarily of dark colors, choose a white background; if the logo consists primarily of bright colors, choose a black background.**

1. Connect the laptop to the switcher's **HDMI Input Port**.
2. Press the **MENU** button to open the OSD Menu on the four-quadrant Multiview display.
3. In the **Lumakey** menu, set the "**Lumakey Source**" to **Input 4**.
4. In this example, the logo is against a black background so **Black Mode** is chosen.
5. Set the "**Cleanup Level**" to 10 if the background is in total black.
6. "**Transparency**" is set to 64 if an opaque logo is desired. **Opaque** logo can be created by setting the "**Transparency**" to 64. **Semi-transparency** effect can be generated by setting the "**Transparency**" to a value between 0 and 64.
7. Exit the menu after the Logo is properly configured.
8. Press the **Luma Key PGM** button to place the logo on the Program screen or the **Luma Key PVW** button to place the logo on the Preview screen.

### 5.2 Connecting PTC-150T Cameras

DVIP is a communication interface that allows the user to control multiple PTC-150T cameras remotely. Follow the steps outlined below to set up your PTC-150T cameras with the HS-1600T MKII.

1. Locate the DIP switch at the bottom of the PTC-150T camera



2. Set DIP Switch positions 1 and 4 to ON

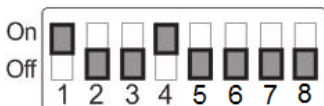

3. Power **ON** the PTC-150T PTZ Camera.
4. Open the main menu by pressing the **MENU** button on the HS-1600T MKII's keyboard panel and select option 4 "**Remote Control**".

```
[MAIN MENU]
1: CAMERA SET (NORMAL)
2: MEMORY
```

```
3: VIDEO OUTPUT
4: REMOTE CONTROL
5: SYSTEM
6: CAMERA SET (ADVANCE)
7: RESET P/T/Z
8: ESCAPE
```

5. Select “**SET DVIP**” to configure the DVIP port.

```
[REMOTE CONTROL]
1: PAN/TILT REVERSE: P+T
2: REMOTE SOURCE: DVIP, SW
3: SET RS422
4: SET DVIP
5: SET IR
6: PTZ INFO. OUTPUT: OFF
7: ESCAPE
```

6. Set the **DVIP baud** to 38400.

```
[SET DVIP]
1: DVIP BAUDRATE: 38400
2: ESCAPE
```

7. Connect the PTC-150T to the HS-1600T MKII, which should automatically assign an IP to the PTC-150T.

# Chapter 6 Video Streaming and Recording

The HS-1600T MKII 4 Channel HD/SD HDBaseT Portable Video Streaming Studio includes a built-in Video Streaming Server (NVS-31 MARK II) allowing the user to concurrently stream and record your program at the same time. From any SDI/HDMI input sources, the Datavideo’s video streaming server generates an H.264 encoded stream that is compliant with RTSP or RTMP protocols. While encoding the video at bit rates appropriate for live streaming, the Datavideo NVS-31 MARK II concurrently records a high-quality MP4 file to an SD card.

**Note:** *The built-in video streaming server and recording device are referred to as NVS-31 MARK II.*

## 6.1 Streaming Network Connection and Device Search

This section details how to connect the NVS-31 MARK II to a network with or without a DHCP server, and describes how to acquire the NVS-31 MARK II’s IP address.

### Connecting to a DHCP Network (DHCP Mode)

Follow the procedure below to scan your DHCP network for connected NVS-31 MARK II devices.

**Note:** *The NVS-31 MARK II will be automatically assigned an IP address upon connection to the DHCP network.*

1. Connect the NVS-31 MARK II’s stream port to the network via an Ethernet cable.
2. Turn on the HS-1600T MKII’s power and the NVS-31 MARK II will also be turned ON in the DHCP mode by default.
3. Connect the laptop to the same network that the NVS-31 MARK II is connected to and download the free IP Finder utility program.
4. Double click the IP Finder utility program icon to open the IP Finder interface.
5. Click the **SCAN** button to start searching for connected devices.

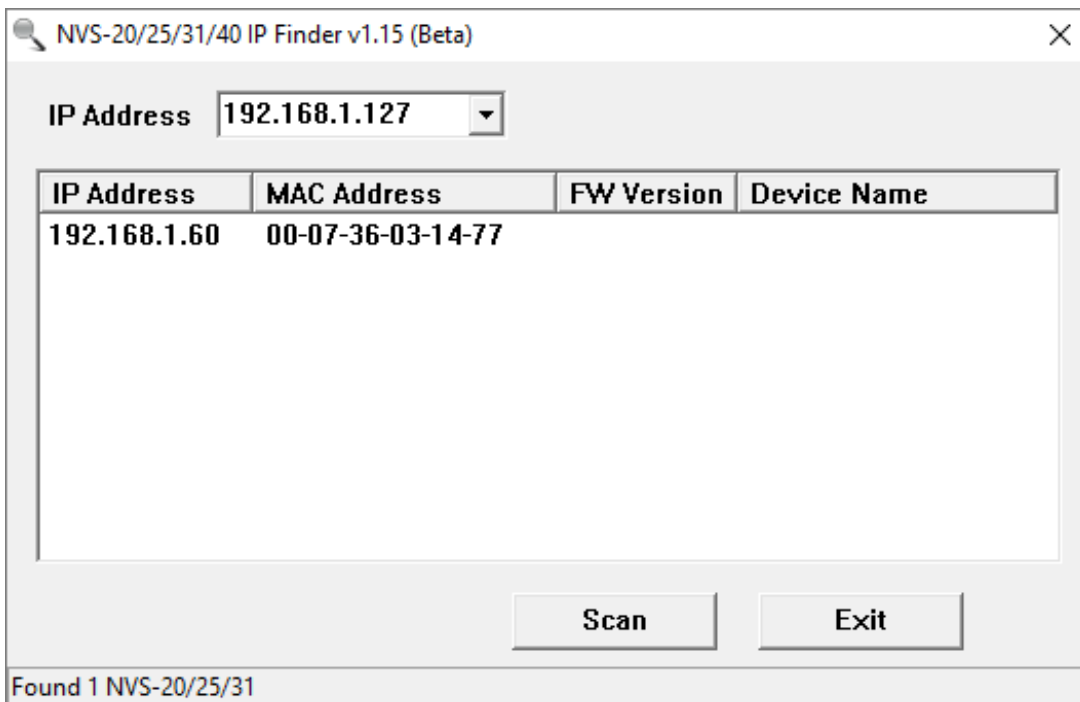
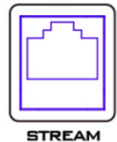



## Connecting to a NON-DHCP Network (Static IP)

Upon connection to a non-DHCP network, the NVS-31 MARK II will not be assigned of any IP addresses. As such it is recommended that you manually assign a fixed IP address to the device or use the default IP address (**192.168.1.200**).

### Default Fixed IP

Default Fixed IP is primarily used in point-to-point connection, such as connecting the PC to the NVS-31 MARK II directly. In a non-DHCP environment, the NVS-31 MARK II works in fixed IP mode only. To configure the NVS-31 MARK II to the **default IP**, please follow the steps outlined below:

1. Connect the NVS-31 MARK II's stream port to the network via an Ethernet cable.
2. Turn on the HS-1600T MKII's power and the NVS-31 MARK II will also be turned ON in the DHCP mode by default.
3. Search for the NVS-31 MARK II device according to the method as detailed in the previous DHCP section. Once found, log into the user interface on the web browser.
4. Open the system page by clicking the "System" tab on the home of the user interface.
5. In the "Network Setting", disable the DHCP mode.
6. You will then be allowed to manually enter the static IP address once the DHCP mode is disabled. The static IP is 192.168.1.200 by default. The subnet mask and default gateway are 255.255.255.0 and 192.168.1.254 respectively.

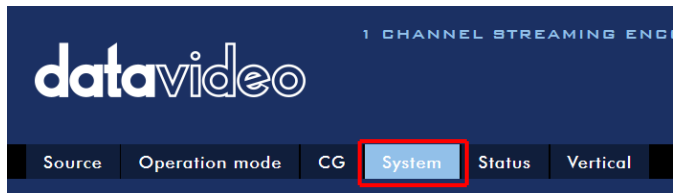

**Tip: If you forget or lose the IP address, do the following to reset the network settings.**

- Turn off the device.
- Press the **RECORD** and **STREAM** buttons at the same time then turn ON the power of the device
- Wait for about five seconds and release the button push as soon as you see the **RECORD** and **STREAM** button LEDs light up.
- The IP address should be the default IP which is **192.168.1.200**.

### Troubleshooting the Network Connection

Connect the NVS-31 MARK II to the network and open the IP Finder utility program. Scan for the device. If not found, it is possible that your network is not assigning IP addresses. Reasons of this are listed as follows:

- Router or DHCP server is not connected to the network.
- New devices are blocked by the network administrator.
- Anti-virus software or the firewall blocks the communication.

Solve the problem by attempting the following:

- Turn off the router, wait for 10 seconds then turn on the router again.
- Reset the NVS-31 MARK II to the factory default:
  - Turn off the device.

- Push the **Record and Stream** buttons simultaneously while turning on the device's power.
- Wait for about five seconds and release the button push as soon as you see the **RECORD** and **STREAM** button LEDs light up.
- Reboot the PC.

If the problem persists, try the following:

- Temporarily shut down the anti-virus software or firewall.
- Make sure no other devices are connected to the LAN (wired or wireless) because this may result in IP conflicts.

After trying all methods and if the problem is still not solved, the NVS-31 MARK II video streaming server offers the fixed IP feature that allows you to establish direct connection to the NVS-31 MARK II. The default IP address is 192.168.1.200.

This method allows you to configure the NVS device to the IP range of your network so that you do not need a DHCP server to gain access to the NVS device.

- Connect your PC to the NVS device directly using an Ethernet cable (not necessarily a crossover cable).

Next, change the network settings of your PC or laptop.

- Click **START** located at the bottom left corner of your screen.
- On the text bar, enter **Network Connections** then click the icon that appears.
- Double click the network adapter that connects your PC or laptop to the network.
- Click the "**Properties**" button.
- Select "**Internet Protocol Version 4 (TCP/IPv4)**" option and click the "**Properties**" button.
- Check the "**Obtain an IP address automatically**" option.
- Enter IPv4 settings:
  - IP Address: 192.168.1.2
  - Subnet Mask: 255.255.255.0 (System default is 255.255.255.0)
  - Default Gateway: Not required for one-to-one connection.

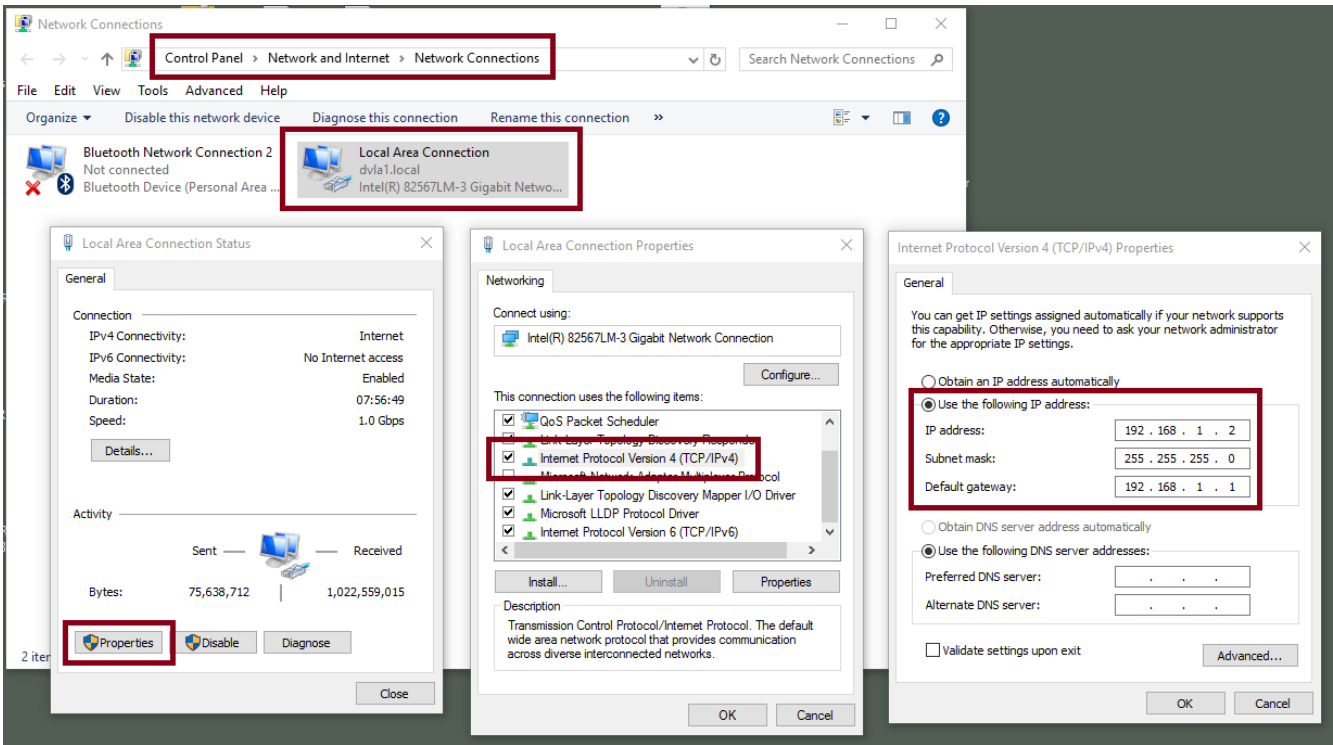

**Note:** Please write down the IPv4 address previously entered as it may be needed after you are done with streaming or recording.

- The NVS-31 MARK II should now be connected with an IP address of 192.168.1.200. If the NVS-31 MARK II still cannot connect, simply restore the NVS-31 MARK II to the factory defaults.
  - Turn off the device.
  - Push the **Record and Stream** buttons simultaneously while turning on the device's power.
  - Wait for about five seconds and release the button push as soon as you see the **RECORD** and **STREAM** button LEDs light up.
  - Make sure no other devices are connected to the LAN (wired or wireless) because this may result in IP conflicts.
- Login the NVS-31 MARK II via a web browser.
  - Default user name is **admin**
  - Default password is **000000**
- Click the "**System**" tab then on the system page, enter network settings such as static IP and default gateway. Make sure that the default gateway matches your connected network and no device shares the same IP as the NVS-31 MARK II. For example, if your router's default gateway IP is 10.10.1.1, then in the default gateway field, you should also enter 10.10.1.1. Then set the IP address of the NVS-31 MARK II to 10.10.1.X, which can range from 10.10.1.2 to 10.10.1.255. Pick an unused IP address.

Network Setting	
DHCP	Static IP
Enable	192.168.1.200
Subnet Mask	Default Gateway
255.255.255.1	192.168.1.1
Primary DNS	Secondary DNS
192.168.1.100	0.0.0.0

- DHCP: Disable
- Static IP: X.X.X.Y; the first three decimal numbers must be the same as your router or switch. The number Y must be a number not used by any devices connected to the network.
- Subnet Mask: 255.255.255.0
- Default Gateway: Z.Z.Z.Z; same as the gateway IP of your router or switch.

**Note: Some router may require special gateway IP setting; instead of the standard 192.168.1.1. Therefore, you should check the network properties on the PC before switching to the fixed IP mode.**

**For example, some routers have a gateway IP of 192.168.1.254 and as a result, the default gateway and primary DNS fields on the NVS-31 MARK II must also be configured to 192.168.1.254.**

- Primary DNS: Same as the default gateway IP, which, if causing issues, can be changed to 8.8.8.8 or 8.8.8.4 (Public DNS provided by Google).
- Click the **“Submit”** button to save the network settings.
- Reconnect the PC and the NVS-31 MARK II to the network.
- Restore the PC’s original network settings.
- Shut down the HS-1600T MKII; wait for approximately five seconds before turning the HS-1600T MKII back ON.
- You should be able to access the NVS-31 MARK II through the fixed IP address.

### **Advanced Troubleshooting**

If you still are unable to connect, please try the following:

- Use the ARP table to search for the encoder’s MAC address; the device’s MAC address is on the print label at the bottom of your HS device.
- MAC address starts with **00:07:36:03:xx:xx**.
  - Device’s MAC address starts with 00:07:36:07:xx:xx
- On the command prompt (terminal on MAC OS), enter **"arp -a"** then press enter key to display an ARP list. See if the NVS-31 MARK II is successfully connected to the network.
- Execute **services.msc**, and on the right column of the **“Services”** window, locate **“DHCP Client”** then click **“Restart”**.
- On the command prompt, enter **ipconfig/flushdns** followed by **ipconfig/release** and **ipconfig/renew**.

## 6.2 Web User Interface

By now, we have obtained the IP addresses of the PC and the NVS-31 MARK II. Enter the NVS-31 MARK II's IP address into the address bar of a browser then hit the **ENTER** button. Login by entering the user name as well as the password into a pop-up dialogue box as shown below.



**Username: admin**

**Password: 000000**

Click **OK** to login. Once logged in, the first page that appears will be the **Source** page.

### Source

You will see the **Source** page immediately after logging into the NVS-31 MARK II web UI. On the Source page, you will see **Input Information, Video Source, Audio Source, Resolution, Frame Rate, Channels, Bits Per Sample** and **Sample Frequency**.

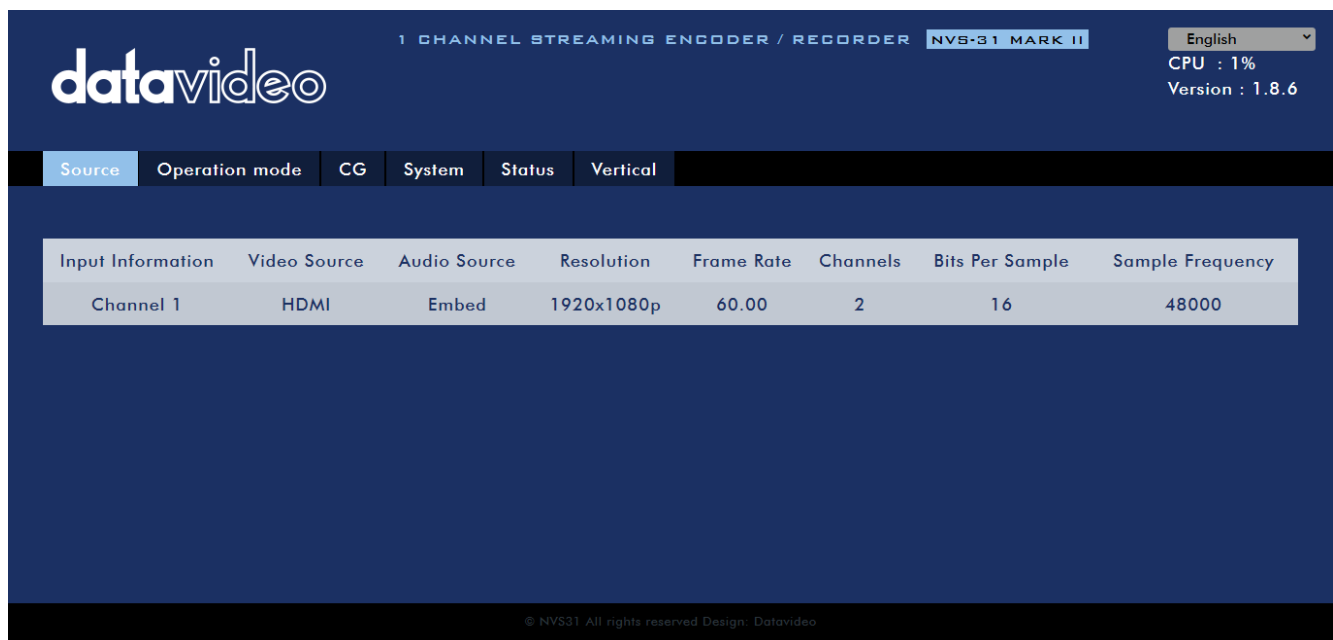

Input Information	Video Source	Audio Source	Resolution	Frame Rate	Channels	Bits Per Sample	Sample Frequency
Channel 1	HDMI	Embed	1920x1080p	60.00	2	16	48000

**Note: The NVS-31 MARK II web UI does not update automatically so to learn the latest device status, please refresh the page manually.**

While monitoring streaming and recording, please update the page periodically regardless of how you operate the device (using the device's physical buttons only or using the device's physical buttons along with the web UI). This ensures the page is always displaying the most up-to-date information.

## Operation Mode

Click the **Operation Mode** tab on the tool bar to open the operation mode configuration page on which the user will be allowed to customize various stream and record settings.

The NVS-31 MARK II offers the following operation modes:

- **Stream**
- **Record**

which will be discussed in detail in this section.

### Stream Mode

The NVS-31 MARK II has two stream engines allowing you to stream to two different destinations over multiple protocols. The configurable stream settings are **Encoder Source**, **Stream Type**, **Resolution**, **Frame Rate**, **Profile**, **Level**, **Entropy**, and **Video Bitrate (bps)** which will be described later in this section.

The screenshot displays the 'Operation mode' configuration page for the NVS-31 MARK II. The interface is divided into two columns for 'Streaming one' and 'Streaming two'. Each column contains a grid of settings:

- Encoder Source:** Enable (dropdown)
- Stream Type:** RTMP (dropdown)
- Resolution:** 1080 x 1920 (dropdown)
- Frame Rate:** 60.00 (dropdown)
- Profile:** Main (dropdown)
- Level:** Level 41 ( FHD ) (dropdown)
- Entropy:** CABAC (dropdown)
- GOP:** 30 (dropdown)
- Encoder Mode:** Medium (dropdown)
- Video Bitrate ( bps ):** 4 M (dropdown)

Additional settings for each stream include:

- Streaming one:** RTMP URL (rtmps://live-api-s.face), Stream Name (10217846917557153), Account, Password.
- Streaming two:** RTSP Port (556), RTSP HTTP Port (8556), Account (root), Password (root).

A **Session Name** field is shared at the bottom, set to 'session0.mpg'. At the top, there are 'Record' and 'Stream' buttons. At the bottom, there are 'Apply', 'Default', and 'Start Stream' buttons. The page header shows '1 CHANNEL STREAMING ENCODER / RECORDER NVS-31 MARK II' and 'English' language selection. System status shows 'CPU : 1%' and 'Version : 1.8.6'.

Four streaming protocols available on the NVS-31 MARK II are **RTSP**, **RTMP**, **HLS**, and **TS**. See [Section 6.3](#) for instructions on each individual stream setup.

Note that once your video streams are set up, click **“Apply”** button to apply the new stream settings. Click **“Start Stream”** to open the stream and **“Stop Stream”** to end the stream. To reset, simply click the default button.

Next, we will discuss the stream setting options in greater detail.

### **Encoder Source**

This option allows you to enable the stream encoder for configurations of various parameters. If the stream encoder is not needed, disable this option.

### **Stream Type**

The NVS-31 MARK II offers the user four stream types which are **RTSP**, **RTMP**, **TS**, and **HLS**. Parameters of each individual protocol will be briefly described below.

#### **RTSP (Real Time Streaming Protocol)**

- RTSP Port: The RTSP port number ranges from 554 to 562 and is 554 by default.
- RTSP HTTP Port: The RTSP HTTP port number ranges from 8553 to 8563 and is 8554 by default.
- Account / Password: The RTSP streaming account credentials which are root/root by default.
- Session Name: The default RTSP session name is session0.mgp.

#### **RTMP (Real-Time Messaging Protocol)**

- RTMP URL: Enter an RTMP URL obtained from any live streaming platform such as Ustream.

**Note: The NVS-31 MARK II supports RTMP Publish only and not RTMP Local.**

- Stream Name: Enter a stream name or key from any live streaming platform such as Ustream.
- Account / Password: Enter the account name and the password of your RTMP platform account.

#### **TS (Transport Stream)**

- TS URL: Enter a URL for your transport stream.

Please note that when streaming, the NVS-31 MARK II converts video into data, which are sent across an IP network. High bitrates consume more bandwidth across the IP network. In a gigabit office LAN, high bitrate may not be a concern and Speed/Bandwidth is therefore not a limitation in an NVS-31 MARK II application environment.

If your available bandwidth is limited, you should reduce both your resolution and your bitrate accordingly. A good rule of thumb is for the bitrate of your stream to use no more than 50% of your available upload bandwidth capacity on a dedicated line. For example, if the result you get from a speed test shows that you have 2Mbps of upload speed available, your video bitrate should not exceed 1Mbps.

## Resolution

The first step of encoder setup is to adjust the image size. It is best to either match your original video source or scale it down. For example, capture at HD 720 and stream at HD 720. Or capture at HD 720 and stream at 540 (high).

You should never be scaling up and streaming at a higher resolution than your original video source. For example, it does not make sense to capture at 720 and stream at 1080. Note that you will also have no gain in quality and you are using more bandwidth than is necessary for your viewers.

You should also be aware that higher resolutions require greater processing power to encode the stream. Attempting too high of a resolution on too little processing power can result in degraded image quality and corrupted or interrupted streams or recordings.

Resolutions available for your stream encoder are listed as follows:

- 1080x1920
- 720x1280
- 576x720
- 480x720
- 480x640

## Frame Rate

Select a frame rate from the drop-down menu for video streaming. Note that frame rates should always match the frame rate of the video source.

- 60.00
- 50.00
- 30.00
- 25.00
- 20.00
- 15.00

## Video Bitrate (bps)

The bitrate of the video specifies the amount of information stored in the video. The higher the bitrate is, the clearer the video is. However, when choosing your encoder settings for streaming, you should first check your available upload bandwidth. A good rule of thumb is for the bitrate of your stream to use no more than 50% of your available upload bandwidth capacity on a **DEDICATED** line. For example, if the result you get from a speed test shows that you have 2Mbps of upload speed available, your combined audio and video bitrate should not exceed 1Mbps.

Usually high bitrate means good image quality; however, there are also exceptions. For example, SD video may appear acceptable at 1000 Kbps (1M) but HD video is unacceptable at 1000 Kbps.

Available video bitrates are listed as follows:

- 10M
- 8M
- 6M
- 4M



- 2M
- 1M
- 512K
- 256K

### Encoder Mode

The Encoder Mode sets the video bitrate mode for your video stream. The available modes are listed as follows:

- High (8M)
- Medium (4M)
- Low (2M)

**Tip:** You can also switch between different bitrate modes by pressing the Bitrate button in the H.264 Encoder button group. See [Section 6.4](#) for details.

### Profile

**Profile** sets the H.264 encoding profile for your stream. The available options are **Baseline**, **Main**, and **High**. Typically, **High** profile provides the best image quality and is suitable in most instances. However, depending on the decoder used when viewing the stream, such as with mobile devices, a Main or Baseline profile may be required.

- High
- Main
- Baseline

### Level

Levels specify the size of the video a decoder must be able to handle. They specify a maximum bit-rate for the video and a maximum number of macroblocks per second. Level numbers range from 1 to 5 with intermediate steps (e.g., 1.1, 1.2, 1.3 and etc). The table below provides a summary of maximum parameters supported by each H.264/AVC level.

Level ID	Max. Video Bitrate in kbits/s	Max Frame Size in macroblocks	Max decoding speed in macroblocks per second	Resolution, Frame Rate (Max Stored Frames)
1.0	64	99	1485	128×96@30.9 (8) 176×144@15.0 (4)
1b	128	99	1485	128×96@30.9 (8) 176×144@15.0 (4)
1.1	192	396	3000	176×144@30.3 (9) 320×240@10.0 (3) 352×288@7.5 (2)
1.2	384	396	6000	320×240@20.0 (7) 352×288@15.2 (6)
1.3	768	396	11880	320×240@36.0 (7) 352×288@30.0 (6)
2.0	2000	396	11880	320×240@36.0 (7) 352×288@30.0 (6)

Level ID	Max. Video Bitrate in kbits/s	Max Frame Size in macroblocks	Max decoding speed in macroblocks per second	Resolution, Frame Rate (Max Stored Frames)
2.1	4000	792	19800	352×480@30.0 (7) 352×576@25.0 (6)
2.2 (SD)	4000	1620	20250	352×480@30.7 (12) 352×576@25.6 (10) 720×480@15.0 (6) 720×576@12.5 (5)
3.0	10000	1620	40500	352×480@61.4 (12) 352×576@51.1 (10) 720×480@30.0 (6) 720×576@25.0 (5)
3.1	14000	3600	108000	720×480@80.0 (13) 720×576@66.7 (11) 1,280×720@30.0 (5)
3.2 (HD)	20000	5120	216000	1,280×720@60.0 (5) 1,280×1,024@42.2 (4)
4.0	20000	8192	245760	1,280×720@68.3 (9) 1,920×1,080@30.1 (4) 2,048×1,024@30.0 (4)
4.1 (FHD)	50000	8192	245760	1,280×720@68.3 (9) 1,920×1,080@30.1 (4) 2,048×1,024@30.0 (4)

## Entropy

There are two coding options available for generating H.264 content:

- CAVLC (Context-Adaptive Variable Length Coding)
- CABAC (Context-based Adaptive Binary Arithmetic Coding)

CABAC encoding provides a 7-10% quality improvement over CAVLC but requires an extra 10-15% CPU. CABAC encoding is only available in H.264 Profiles Main & High. When targeting at low-powered devices, such as older cell phones and tablets, we recommend the Baseline Profile that uses CAVLC which requires less computing power.

## GOP

GOP pattern with longer GOP length encodes video very efficiently. Shorter GOP lengths usually work better with video that has quick movements, but they do not compress the data rate as much.

Depending on your applications, you can select 16 GOP sizes ranging from 1 to 255.

- 255
- 240
- 200
- 120
- 100
- 60
- 50

- 30
- 25
- 20
- 15
- 10
- 5
- 3
- 2
- 1

### Record Mode

The NVS-31 MARK II’s record engine allows you to record your program on the SD card. See [Appendix 2](#) for a list of recommended SD cards. The record parameters shown in the diagram below will be discussed in detail in this section.

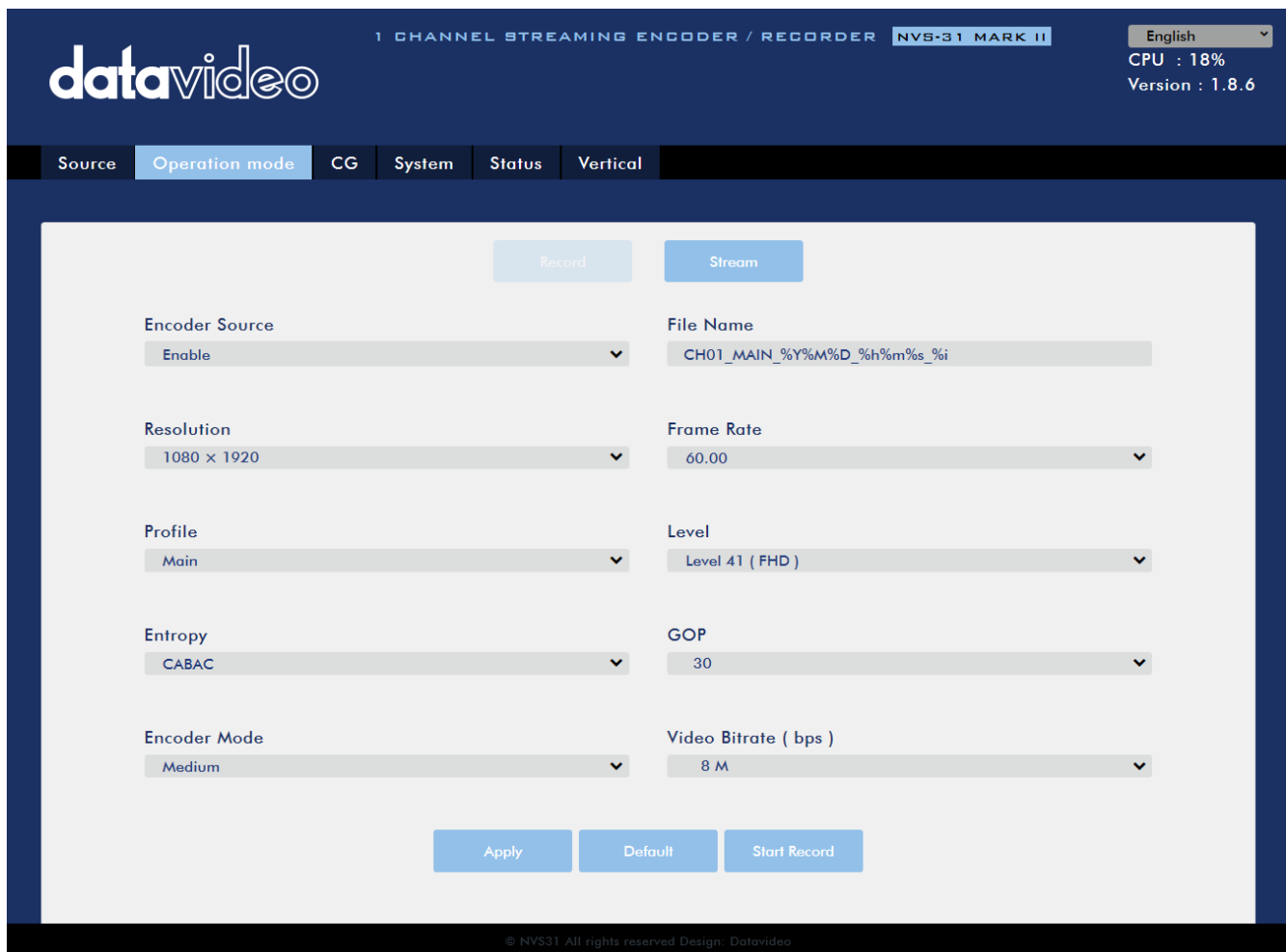

Note that after you’ve configured the record settings, click **“Apply”** to apply the new record settings. Click **“Start Record”** to start recording and **“Stop Record”** to end recording. To reset, simply click the default button.

### Encoder Source

This option allows you to enable the record engine for configurations of various parameters. If the recorder is not needed, disable this option.

## File Name

Enter the name of your record file.

## Resolution

Recording resolution is the number of pixels (dots) used to create an image. Higher resolutions use more pixels to create an image. This means that greater amounts of detail can be expressed in the image, but larger file sizes and a greater amount of storage (i.e. hard drive space) are required to save the images or video.

Resolutions available for your recorder are listed as follows:

- 1080x1920
- 720x1280
- 576x720
- 480x720
- 480x640

## Frame Rate

Select a frame rate from the drop-down menu for video recording.

- 60.00
- 50.00
- 30.00
- 25.00
- 20.00
- 15.00

Frame rate greatly impacts the style and viewing experience of a video. Different frame rates yield different viewing experiences, and choosing a frame rate often means choosing between things such as how realistic you want your video to look, or whether or not you plan to use techniques such as slow motion or motion blur effects.

Below is a list of common options for different applications:

- **24fps** – This is the standard for movies and TV shows, and it was determined to be the minimum speed needed to capture video while still maintaining realistic motion.
- **30fps** – Videos with a lot of motion, such as sports, will often benefit from the extra frames per second.
- **60+fps** – Anything higher than 30fps is mainly used to create slow motion video or to record video game footage.

## Video Bitrate (bps)

The bitrate of the video specifies the amount of information stored in the video. The higher the bitrate is, the clearer the video is.

Available video bitrates are listed as follows:

- 16M
- 12M

- 8M
- 6M
- 4M
- 2M
- 1M
- 512K
- 256K

Recommended video bitrates

- **720P or lower** – 8 – 10 mbps
- **1080P or higher** – 15 mbps or higher

### Encoder Mode

The Encoder Mode sets the video bitrate mode for your recording. The available modes are listed as follows:

- High (8M)
- Medium (4M)
- Low (2M)

**Tip:** You can also switch between different bitrate modes by pressing the **Bitrate** button in the **H.264 Encoder** button group. See [Section 6.4](#) for details.

### Profile

**Profile** sets the H.264 encoding profile for your recorder. The available options are **Baseline**, **Main**, and **High**. Typically, **High** profile provides the best image quality and is suitable in most instances. However, depending on the decoder used when viewing the recording, a Main or Baseline profile may be required.

- High
- Main
- Baseline

### Level

Levels specify the size of the video a decoder must be able to handle. They specify a maximum bit-rate for the video and a maximum number of macroblocks per second. Level numbers range from 1 to 5 with intermediate steps (e.g., 1.1, 1.2, 1.3 and etc). The table below provides a summary of maximum parameters supported by each H.264/AVC level.

Level ID	Max. Video Bitrate in kbits/s	Max Frame Size in macroblocks	Max decoding speed in macroblocks per second	Resolution, Frame Rate (Max Stored Frames)
1.0	64	99	1485	128×96@30.9 (8) 176×144@15.0 (4)
1b	128	99	1485	128×96@30.9 (8) 176×144@15.0 (4)
1.1	192	396	3000	176×144@30.3 (9) 320×240@10.0 (3)

Level ID	Max. Video Bitrate in kbits/s	Max Frame Size in macroblocks	Max decoding speed in macroblocks per second	Resolution, Frame Rate (Max Stored Frames)
				352×288@7.5 (2)
1.2	384	396	6000	320×240@20.0 (7) 352×288@15.2 (6)
1.3	768	396	11880	320×240@36.0 (7) 352×288@30.0 (6)
2.0	2000	396	11880	320×240@36.0 (7) 352×288@30.0 (6)
2.1	4000	792	19800	352×480@30.0 (7) 352×576@25.0 (6)
2.2 (SD)	4000	1620	20250	352×480@30.7 (12) 352×576@25.6 (10) 720×480@15.0 (6) 720×576@12.5 (5)
3.0	10000	1620	40500	352×480@61.4 (12) 352×576@51.1 (10) 720×480@30.0 (6) 720×576@25.0 (5)
3.1	14000	3600	108000	720×480@80.0 (13) 720×576@66.7 (11) 1,280×720@30.0 (5)
3.2 (HD)	20000	5120	216000	1,280×720@60.0 (5) 1,280×1,024@42.2 (4)
4.0	20000	8192	245760	1,280×720@68.3 (9) 1,920×1,080@30.1 (4) 2,048×1,024@30.0 (4)
4.1 (FHD)	50000	8192	245760	1,280×720@68.3 (9) 1,920×1,080@30.1 (4) 2,048×1,024@30.0 (4)

## Entropy

There are two coding options available for generating H.264 content:

- CAVLC (Context-Adaptive Variable Length Coding)
- CABAC (Context-based Adaptive Binary Arithmetic Coding)

CABAC encoding provides a 7-10% quality improvement over CAVLC but requires an extra 10-15% CPU. CABAC encoding is only available in H.264 Profiles Main & High. When targeting at low-powered devices, such as older cell phones and tablets, we recommend the Baseline Profile that uses CAVLC which requires less computing power.

## GOP

GOP pattern with longer GOP length encodes video very efficiently. Shorter GOP lengths usually work better with video that has quick movements, but they do not compress the data rate as much.

Depending on your applications, you can select 16 GOP sizes ranging from 1 to 255.

- 255
- 240

- 200
- 120
- 100
- 60
- 50
- 30
- 25
- 20
- 15
- 10
- 5
- 3
- 2
- 1

## CG

The CG function allows the user to place a textual or picture layer on top of the video. The CG settings are shown in the diagram below.

The screenshot shows the web interface for the NVS-31 MARK II 1 Channel Streaming Encoder / Recorder. The 'CG' tab is selected in the navigation menu. The main content area displays the following settings:

- CG Layer:** Layer 0
- CG Type:** Text
- Text:** CH01 %Y.%M.%D %h:%m:%s
- Text Size:** 36
- Location-X:** 50
- Location-Y:** 50
- Foreground Color:** R: 255, G: 255, B: 255

At the bottom of the settings area, there are four buttons: 'Apply', 'Default', 'Start CG', and 'Stop CG'. The footer of the interface contains the text: © NVS31 All rights reserved Design: Datavideo.

### CG Layer

You are allowed to toggle the CG text or picture between four layers, from layer 0 to layer 3.

### **CG Type**

You may select to place a text (Text) or graphic (Picture) CG object on your video from the drop-down menu.

- **Text**

After setting the CG type to **Text**, you will be allowed to enter the text that you want to place on the video.

Enter CG text in the **Text** field and CG text font size in the **Text Size** field.

- **Picture**

If you set the CG Type to **Picture**, you will be required to select a picture file from your local hard disk. Click **Browse** to browse the hard drive for your graphic CG file.

### **Location-X**

Enter the x-coordinate that determines the horizontal location of the CG object overlaid.

### **Location-Y**

Enter the y-coordinate that determines the vertical location of the CG object overlaid.

### **Foreground Color**

You may either enter the RGB values or select a color from the color spectrum to set the foreground color. Then fine tune the selected color by dragging the circle cursor on the palette. Click the color wheel button at the bottom right corner to confirm the selection.

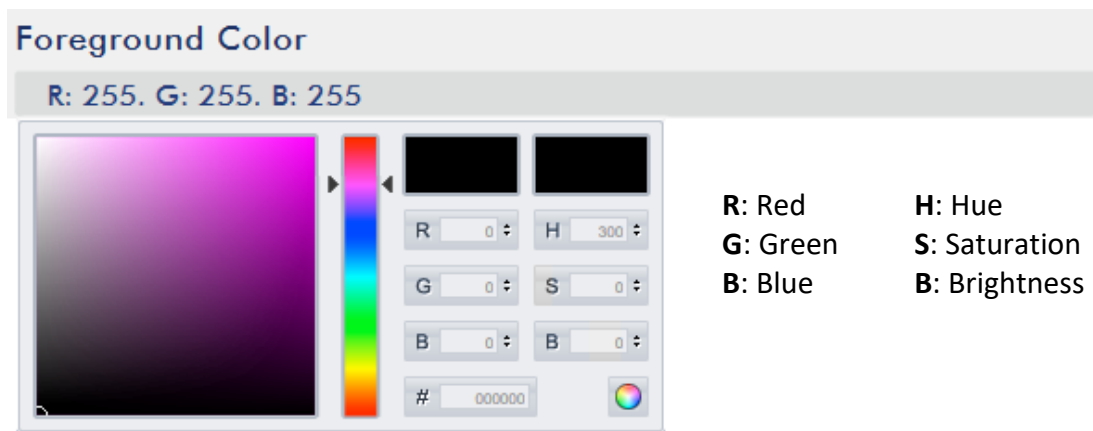

### **System**

The system page allows the user to configure several network and system related settings.

The network settings are **DHCP enable/disable, static IP address, subnet mask, default gateway, primary and secondary DNS**, and etc.

The system settings are **account credentials, time settings, firmware update, disk format and device name**.

The system page is shown in the diagram below.



### Network Setting

DHCP	Static IP
Enable	192.168.1.200
Subnet Mask	Default Gateway
255.255.255.1	192.168.1.1
Primary DNS	Secondary DNS
192.168.1.100	0.0.0.0

Apply Default

### Account and Password

New Account	New Password	Apply
-------------	--------------	-------

### Time Setting

Type	Timezone	Apply
Automatically from the internet	UTC+8	
NTP Server		
time.google.com		

### Firmware Update

File Path	Browse
	Update

### Disk Format

Device	Format Type	Format
Device0:	FAT-32	

### Device Name Setting

Device Name	Apply
-------------	-------

### Other Option

Timeout Period	Apply
20 Min	

### System Control

Restore to Default Reboot

## ***Network Setting***

In network settings, you can either manually enter the IP address or set the device to DHCP mode which allows the router to automatically assign the IP address to the NVS-31 MARK II.

### **DHCP**

In DHCP mode, the router automatically assigns the IP address to the device. If you want to manually configure the network settings, disable this option.

### **Static IP Address**

If the DHCP is disabled, the static IP field will be activated for the user to manually enter the IP address. The static IP address is 192.168.1.200 by default.

**Tip: If you do not know the device's IP address, you can always use the following method to reset the network settings.**

- Shut down the machine
- Turn on the machine while holding down **RECORD** and **STREAM** buttons simultaneously.
- Approximately after 5 seconds, release the **RECORD** and **STREAM** buttons as soon as the button LEDs are turned **ON**.
- The default IP address should be 192.168.1.200.

### **Subnet Mask**

Static IP address mode requires the **subnet mask**, which is 255.255.255.0 by default.

### **Default Gateway**

Static IP address mode requires the **default gateway**, which is 192.168.1.254 by default.

### **Primary DNS (Optional)**

Primary DNS is required in static IP mode only but is optional.

### **Secondary DNS (Optional)**

Secondary DNS is required in static IP mode only but is optional.

### ***Account and Password***

Set the NVS-31 MARK II's account name and password here. Click **Apply** to save the new login credentials.

### ***Time Setting***

In time setting, you are allowed to select the reference time source for the NVS-31 MARK II.

### **Type**

In this drop-down menu, you can either select to allow the device to retrieve the time automatically from the Network Time Protocol (NTP) server by selecting "**Automatically from the Internet**" or locally by selecting "**Manual**".

### ***NTP Server***

If you've selected "**Automatically from the Internet**," you will need to enter the NTP server address here. An example of the NTP server address is time.google.com.

### **Manual**

If you've selected "**Manual**", the **Date** and **Time** fields will appear showing the device's system date and time values. A calendar will appear after the **Date** field is clicked. Simply click a day to set the date. Set the time in the **Time** field.

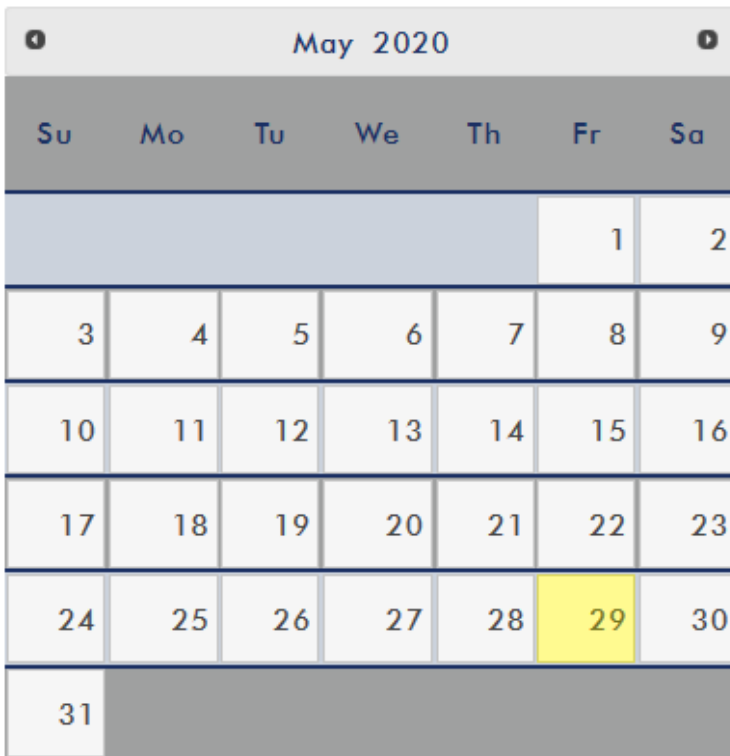

### **Time Zone**

Click the drop-down menu to select a time zone for your device.

After you've configured the time settings, click **Apply** to save the new settings.

### **Firmware Update**

Click **Browse** to search for the latest firmware file saved on the PC's hard disk. After the latest firmware file is uploaded, click **Update** to start the firmware update.

### **Disk Format**

In this pane, you will be allowed to view the SD card information and format the SD card to one of the format types listed as follows:

- FAT-32
- NTFS
- EXFAT

Click **Format** to start formatting.

### **Device Name Setting**

Enter a name for this device and click **Apply** to save the name.

## Other Option

### Timeout Period

This sets the timeout period for the current login. See below for available options.

- 20 Min
- 120 Min
- 1 Day
- 7 Day
- Never

## System Control

### Restore to Default

Click to restore the system's default settings.

### System Reboot

Click to reboot the NVS-31 MARK II.

## Status

The status page shows **Record**, **Stream** and **Disk** information as depicted in the diagram below.

**Note: The NVS-31 MARK II web UI does not update automatically so to learn the latest device status, please refresh the page manually.**

The screenshot shows the DataVideo web UI for the NVS-31 MARK II device. The top navigation bar includes 'Source', 'Operation mode', 'CG', 'System', 'Status' (selected), and 'Vertical'. The 'Status' page is divided into three main sections: Record Status, Stream Status, and Disk Information.

Record Status	
Resolution	NA
Frame Rate	NA
Video Bitrate ( bps )	NA

Stream Status	
Streaming one	
Resolution	1080x1920
Frame Rate	60
Video Bitrate ( bps )	4M
Streaming two	
Resolution	1080x1920
Frame Rate	60
Video Bitrate ( bps )	8M

Disk Information	
Name	NA
Capacity	NA
Format Type	NA
Status	NA

While monitoring streaming and recording, please update the page periodically regardless of how you operate the device (using the device's physical buttons only or using the device's physical buttons along with the web UI). This ensures the page is always displaying the most up-to-date information.

## Vertical

On this page, you will be able to change your stream video orientation.

- Crop: Designed for HS-1600T MKII product series allowing 16:9 video output and left/right image crop.

- Rotate: Designed for video production; if the camera is placed upside down, this mode will reverse it.



## 6.3 Operations

In this section, we will discuss how you can play the video using different streaming protocols and how to place texts on your video.

### **Video Streaming**

The NVS-31 MARK II provides the user with different video streaming options such as RTSP, TS, RTMP, and HLS.

This section discusses settings of these options and how to stream your video using these methods.

### **RTSP/TS/HLS**

In the **RTSP/TS/HLS** modes, the **NVS-31 MARK II** is a stream server which allows any client device to connect and playback your video stream.



The following operation procedure uses VLC media player to playback video stream. If your PC or laptop does not have VLC media player installed, please visit VideoLAN's official homepage (<https://www.videolan.org/>) and download the installation file then install the program.

**Follow the steps below to obtain the RTSP URL:**

1. On the web UI, click "Operation Mode" → "Stream" to open the stream settings page.
2. Select **RTSP** from **Stream Type** drop-down menu.

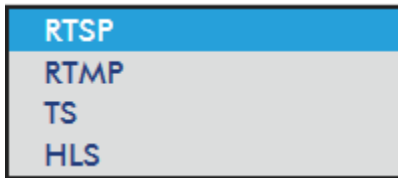

3. Click the **Start Stream** button to generate the RTSP URL.



4. Based on your settings, the device will automatically generate the RTSP URL **rtsp://root:root@192.168.1.82:556/session0.mpg.**

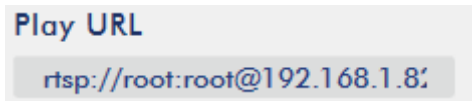

5. To view the RTSP video stream, enter the RTSP URL into the client device.

6. Open VLC then click **Open Network Stream** (shown in the diagram below).

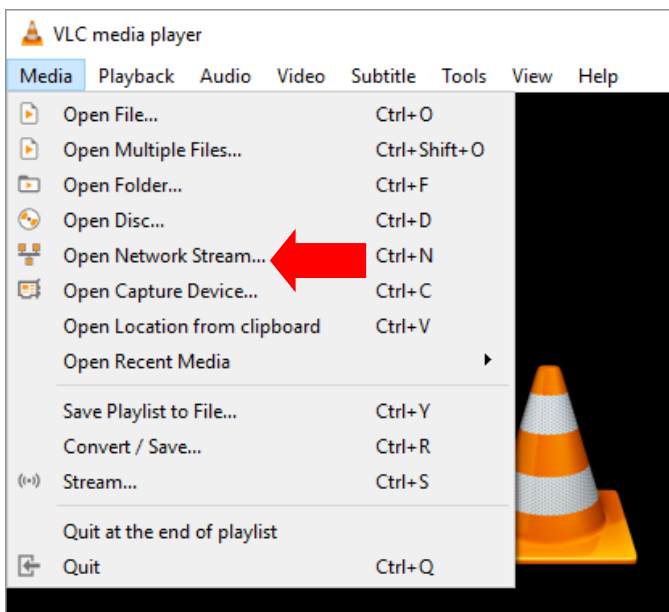

7. As shown in the diagram below, enter the stream URL then click **Play** to start streaming.

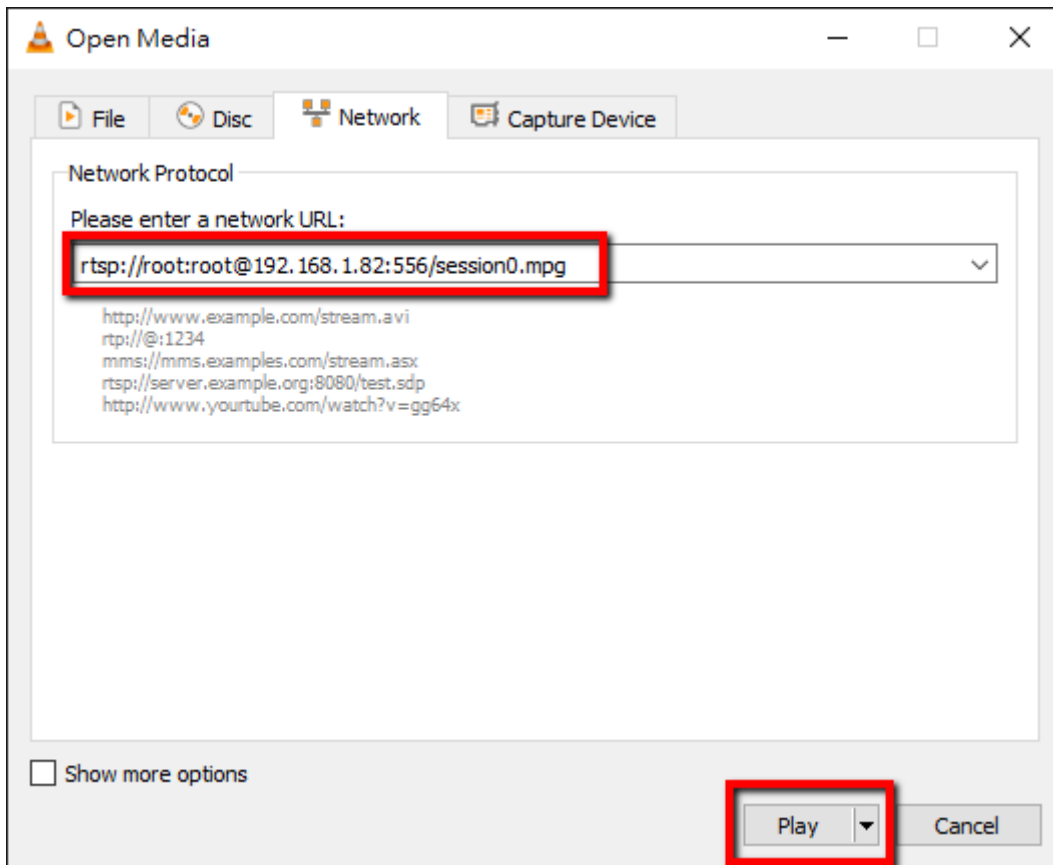

**Follow the steps below to obtain the TS URL:**

1. On the web UI, click **“Operation Mode”** → **“Stream”** to open the stream settings page.
2. Select **TS** from **Stream Type** drop-down menu.

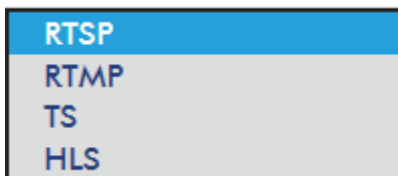

3. Enter the TS URL. Note that the TS URL shown below is only for illustration purpose.



4. Click the **Start Stream** button to start the stream.



5. Enter the TS play URL into the client device to which the video stream is delivered over TS protocol.
6. On the computer, open VLC then click **Open Network Stream** (shown in the diagram below).

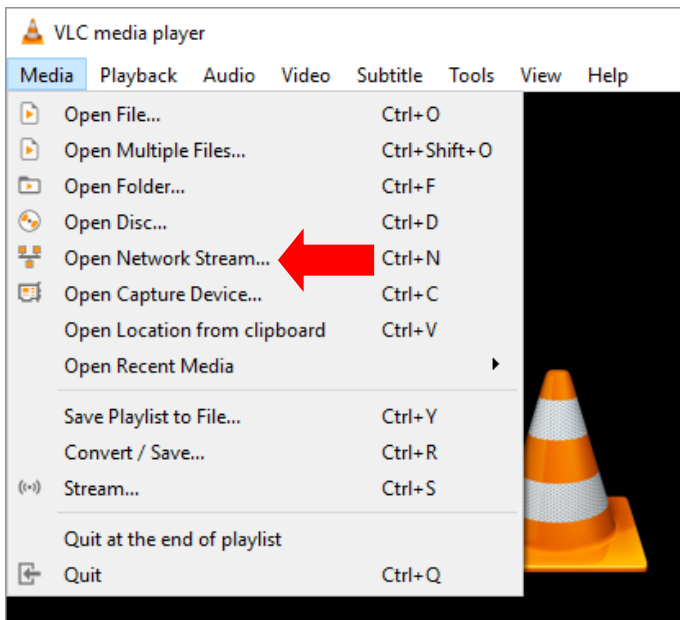

7. As shown in the diagram below, enter the stream URL then click **Play** to start streaming.

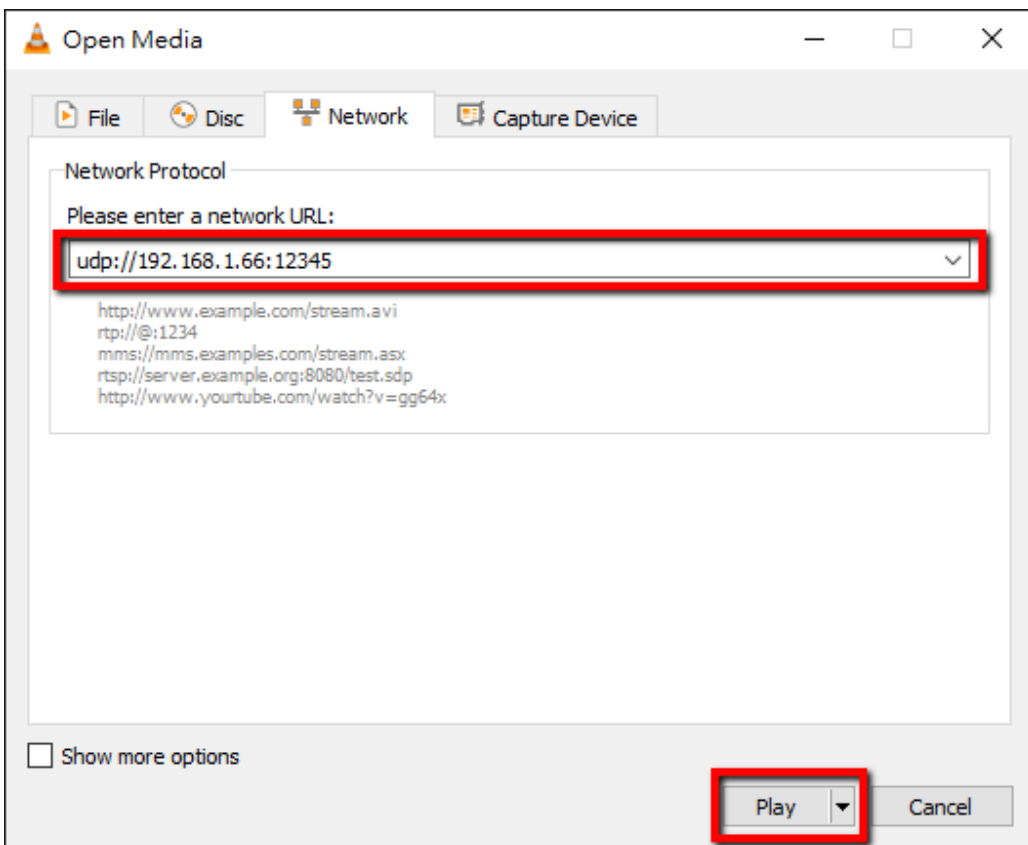

**Follow the steps below to obtain the HLS URL:**

1. On the web UI, click “**Operation Mode**” → “**Stream**” to open the stream settings page.
2. Select **HLS** from **Stream Type** drop-down menu.

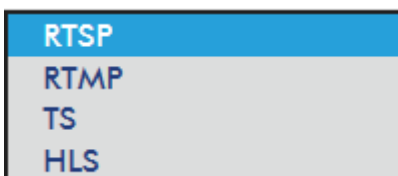



3. Click the **Start Stream** button to start the stream.

### Play URL

<http://192.168.1.82/hls/2/ses>

4. Based on your settings, the device will automatically generate a .m3u8 stream URL:  
<http://192.168.1.82/hls/2/session0.m3u8>
5. Enter the **HLS** URL into the client device.
6. Open VLC then click **Open Network Stream** (shown in the diagram below).

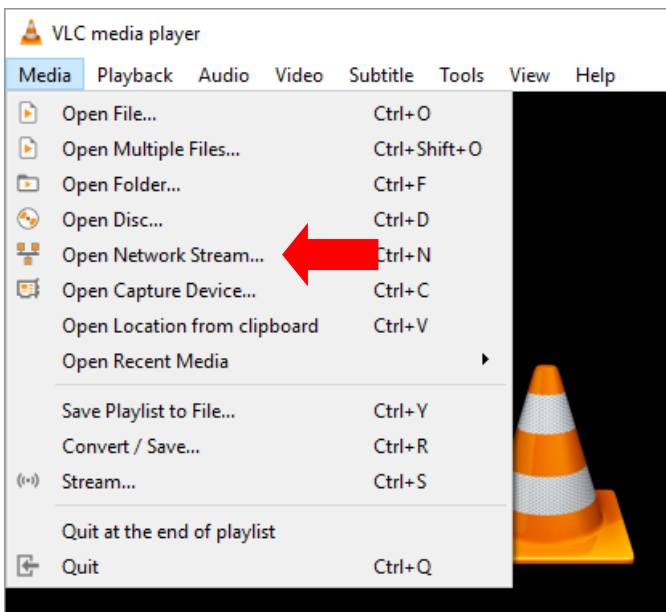

7. As shown in the diagram below, enter the stream URL then click **Play** to start streaming.

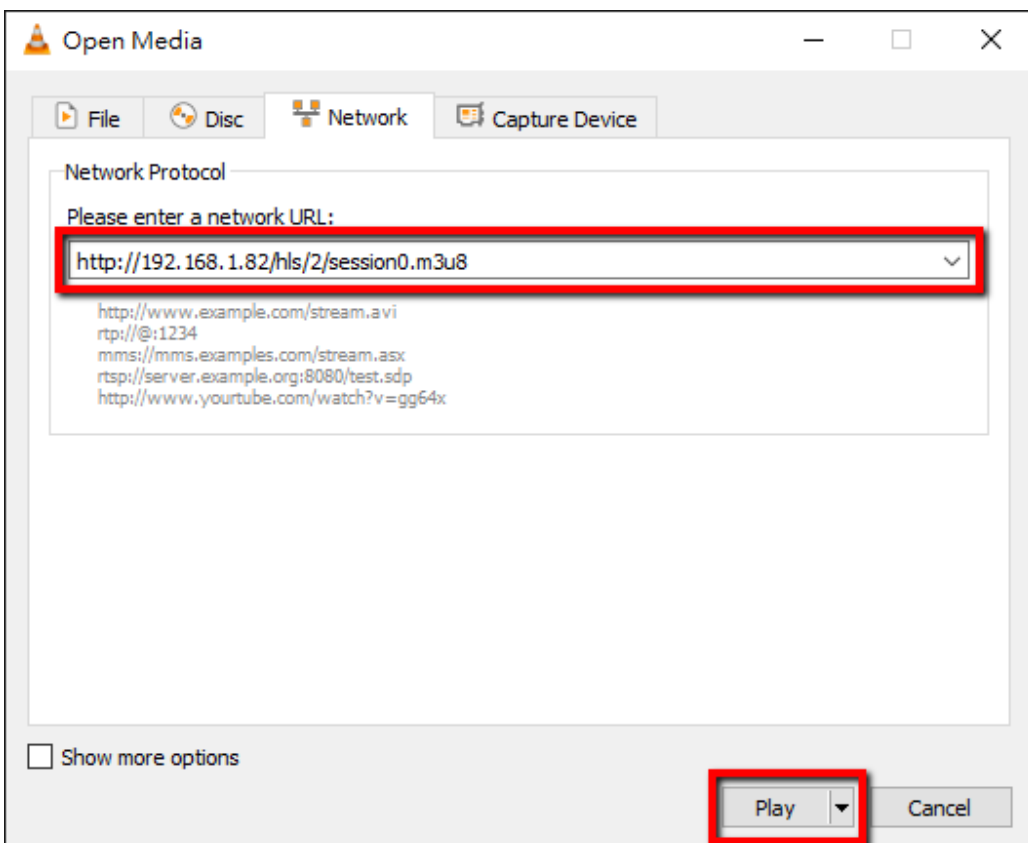

8. You can also play .m3u8 stream URL using the devices listed as follows:
  - iPhone, iPad and MacBook: Use Safari to open the .m3u8 stream URL.
  - Windows 10: Use Microsoft Edge to open the .m3u8 stream URL.

### **RTMP**

In the **RTMP** mode, the NVS-31 MARK II can send up to two data streams to multiple CDNs or media servers that support the **Real-Time Messaging Protocol**. Examples of the **RTMP** media server are **USTREAM** and **Youtube**.

**Note: The NVS-31 MARK II does not support RTMP local.**

In the following section, we will show you how to set up an **RTMP** stream to **Youtube**. The step-by-step account setup is outlined as follows:

1. First, obtain the Server URL and Stream name/key from Youtube.
2. Open the Youtube Live Dashboard [https://www.youtube.com/live\\_dashboard](https://www.youtube.com/live_dashboard)
3. On the left column, locate and click “**Stream now.**”

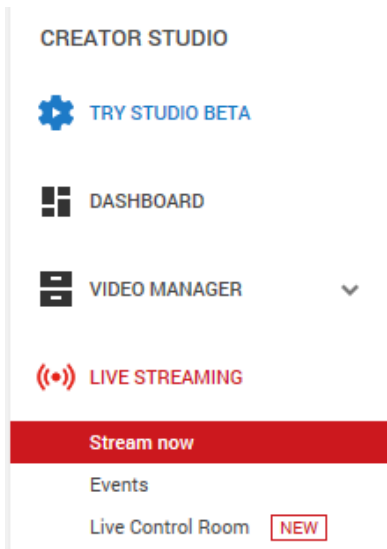

4. On the right, scroll down to the bottom where you will be able to find **Server URL** and **Stream name/key**.

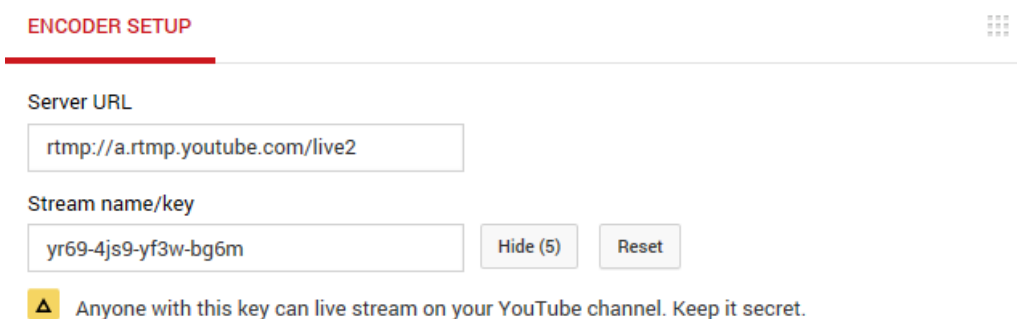

5. On the NVS-31 MARK II, open the **Stream** operation mode page.
6. Select **RTMP** from the Stream Type drop-down menu.

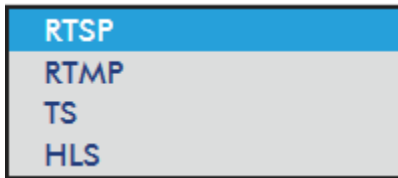

7. Enter the **Server URL** (`rtmp://a.rtmp.youtube.com/live2`) obtained from the **Youtube Live Streaming** page into the **RTMP URL** field.



8. Enter the **Stream name/key** (`yr69-4js9-yf3w-bg6m`) obtained from the **Youtube Live Streaming** page into the **StreamName** field.



9. As required by the live streaming channel, enter your Youtube account name and password into the **Account** and **Password** fields.



10. Click the **Start Stream** button to start streaming the live video to the **Youtube Live**. You should also see an **RTMP URL** generated.

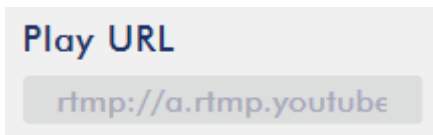

11. At this point, you should be able to view your stream video on Youtube.
12. To stop live streaming, simply click the **Stop Stream** button.

### ***Text Overlay Video***

The HS-1600T MKII's built-in video streaming server not only allows you to stream and record your program, it also features a CG tool that is capable of overlaying text on the video currently being broadcast.

The CG settings page is shown below:

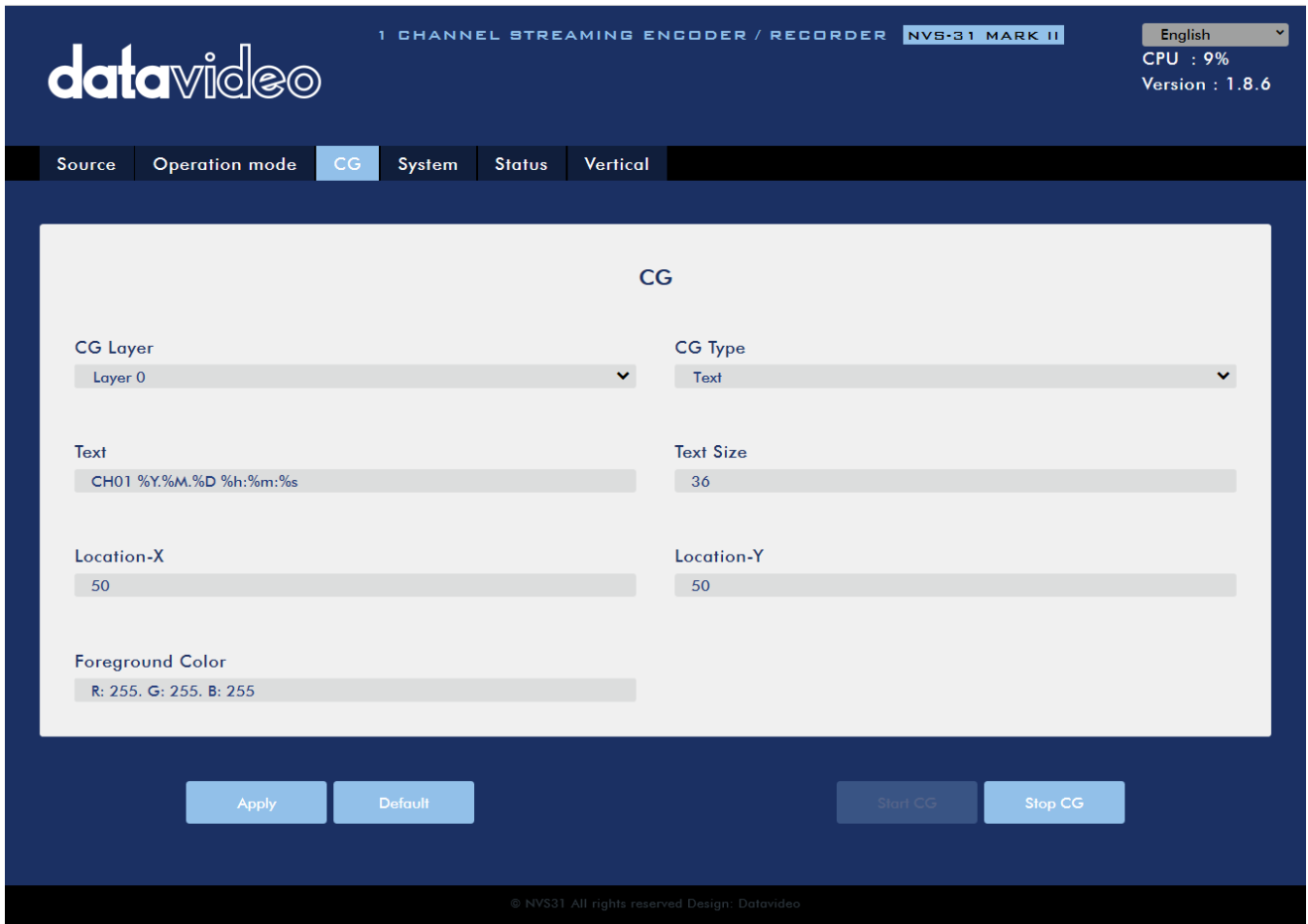

Follow the steps below to overlay text on the video:

1. Open the **CG** settings page.
2. Set the CG layer.
3. Select the CG Type.
4. If Text is selected, enter the overlay text in the **Text** field, otherwise browse for the picture file on the disk.
5. Enter the **X and Y coordinates** to set the CG object position.
6. If you have selected the picture CG, you will need to adjust the object's width and height as well.
7. Set the foreground color.
8. Click **Apply** button to save CG settings.

**Note:** Increasing the X coordinate moves the overlay object to the right and decreasing the X coordinate moves the overlay object to the left; increasing the Y coordinate moves the overlay object down and decreasing the Y coordinate moves the overlay object up.

## 6.4 Record/Stream Panel

The **RECORD**, **STREAM**, **VERTICAL** and **BITRATE** buttons on the front panel of the HS-1600T MKII give the user certain controls of the record and stream functions. In this section, we will cover operations of these four buttons in detail.

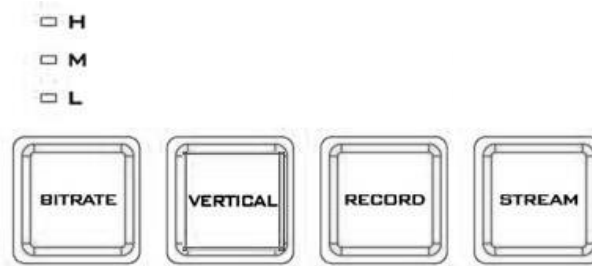

The table below summarizes the **RECORD** and **STREAM** Button LED behaviors:

	<b>RECORD Button</b>	<b>STREAM Button</b>
<b>Solid White</b>	Record function in idle state	Stream function in idle state
<b>Blinking Red</b>	Record function is activating or resetting	Stream function is activating or resetting
<b>Solid Red</b>	Record function activated	Stream function activated

### **Record Button**

Press the **RECORD** button to start/stop recording.

#### **Start recording**

- When idle, the **RECORD** button is solid white.
- Press and hold the **RECORD** button for approximately 2 seconds.
- When the record function is activating, the **RECORD** button turns from solid white, then blinking red and finally to solid red.
- When the **RECORD** button is solid red, this indicates that the record function has been successfully activated.

#### **Stop recording**

- While recording, the **RECORD** button is solid red.
- Press and hold the **RECORD** button for approximately 2 seconds.
- When the record function is terminating, the **RECORD** button turns from solid red, then blinking red and finally to solid white.
- When the **RECORD** button is solid white, this indicates that the record function has been successfully terminated.

### **Stream Button**

Press the **STREAM** button to start/stop streaming.

#### **Start streaming**

- When idle, the **STREAM** button is solid white.

- Press and hold the **STREAM** button for approximately 2 seconds.
- When the stream function is activating, the **STREAM** button turns from solid white, then blinking red and finally to solid red.
- When the **STREAM** button is solid red, this indicates that the record function has been successfully activated.

### Stop streaming

- While streaming, the **STREAM** button is solid red.
- Press and hold the **STREAM** button for approximately 2 seconds.
- When the stream function is terminating, the **STREAM** button turns from solid red, then blinking red and finally to solid white.
- When the **STREAM** button is solid white, this indicates that the stream function has been successfully terminated.

### Bitrate Button

Follow the steps below to switch the stream bitrate mode using the **BITRATE** button:

- Press and hold one of the **RECORD** button and **STREAM** button until the pressed button starts blinking red.
- Continue holding down one of the **RECORD** button and the **STREAM** button while pressing the **BITRATE** button to switch stream bitrate mode (H, M or L).

**Note: The system will return to original settings if the BITRATE button push is not sensed. The default bitrate is M.**

### Vertical Button

Press the **Vertical** button to switch the video orientation between **Portrait** and **Landscape**.

## 6.5 Restoring Factory Defaults

On the system page, scroll down to **System Control** in which you should be able to find the **Restore to Default** button. Click to restore the system's factory defaults. Alternately, you can follow the steps below to restore the NVS-31 MARK II's factory defaults.

- The **RECORD** and **STREAM** buttons are either solid white and solid red, which means the factory defaults can be restored regardless of the state of the device.
- Press and hold the **RECORD** and **STREAM** buttons simultaneously for more than 10 seconds.
- While the NVS-31 MARK II's factory defaults are being restored, the **RECORD, STREAM, VERTICAL** and **BITRATE** buttons turn from solid red, then blinking red and finally to solid white.
- When the **RECORD, STREAM, VERTICAL** and **BITRATE** buttons turn solid white, it indicates that the NVS-31 MARK II's factory defaults have been successfully restored.

## 6.6 Firmware Update

Datavideo usually releases new firmware containing new features or reported bug fixes from time to time. See [System](#) → [Firmware Update](#) for instructions on NVS-31 Mark II firmware update.

# Chapter 7 Appendices

## Appendix 1 Tally Outputs

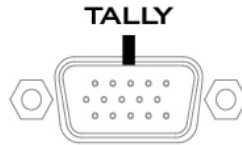

The HS-1600T MKII has a D-sub 15 pin female tally output port. These connections provide bi-colour tally information to a number of other Datavideo products, such as the ITC-100 eight channel talkback system and the TLM range of LCD Monitors. The ports are open collector ports and as such do not provide power to tally light circuits.

The pin outputs are defined as follows:

PIN No.	Signal Name	Input/Output	Description of Signal
1	Program 1	Open collector output	Tally output of input video Program 1
2	--	--	No Function
3	Preview 1	Open collector output	Tally output of input video Preview 1
4	RCOM (GND)	Ground	Ground
5	Program 4	Open collector output	Tally output of input video Program 4
6	Program 2	Open collector output	Tally output of input video Program 2
7	--	--	No Function
8	Preview 2	Open collector output	Tally output of input video Preview 2
9	GND	Ground	Ground
10	--	--	No Function
11	Program 3	Open collector output	Tally output of input video Program 3
12	--	--	No Function
13	Preview 3	Open collector output	Tally output of input video Preview 3
14	YCOM (GND)	Ground	Ground
15	Preview 4	Open collector output	Tally output of input video Preview 4

## Appendix 2 Firmware Upgrade

Datavideo usually releases new firmware containing new features or reported bug fixes from time to time. Customers can either download the HS-1600T MKII firmware as they wish or contact their local dealer or reseller for assistance.

This section outlines the firmware upgrade process which should take **approximately 10 minutes to complete**. The existing HS-1600T MKII settings should persist through the **firmware upgrade process, which should not be interrupted once started** as this could result in a non-responsive unit.

### Keyboard / Mainboard

Successful firmware upgrade on HS-1600T MKII requires:

- HS-1600T MKII x 1
- 48V Power adapter x 1
- USB thumb drive x 1
- USB Cable x 1

### Update Procedure

1. On the PC, copy the two HS-1600T MKII firmware binary files to the root directory of a USB thumb drive. After the files are successfully copied, safely remove the USB thumb drive from the PC.
  - **HS-1600T MKII.bin**: The HS-1600T MKII Keyboard (KB) Firmware is approximately 27KB and usually with a version number of V1.X.
  - **HS-1600T MKIIM.bin**: The firmware file for the HS-1600T MKII Mainboard (MB) and OSD MENU fonts is approximately 2-3 MB (Example of the firmware display is V1.16 for the mainboard and V1.02 for OSD fonts).
2. Connect the USB thumb drive to the F/W Upgrade USB port located on the back of the HS-1600T MKII device.

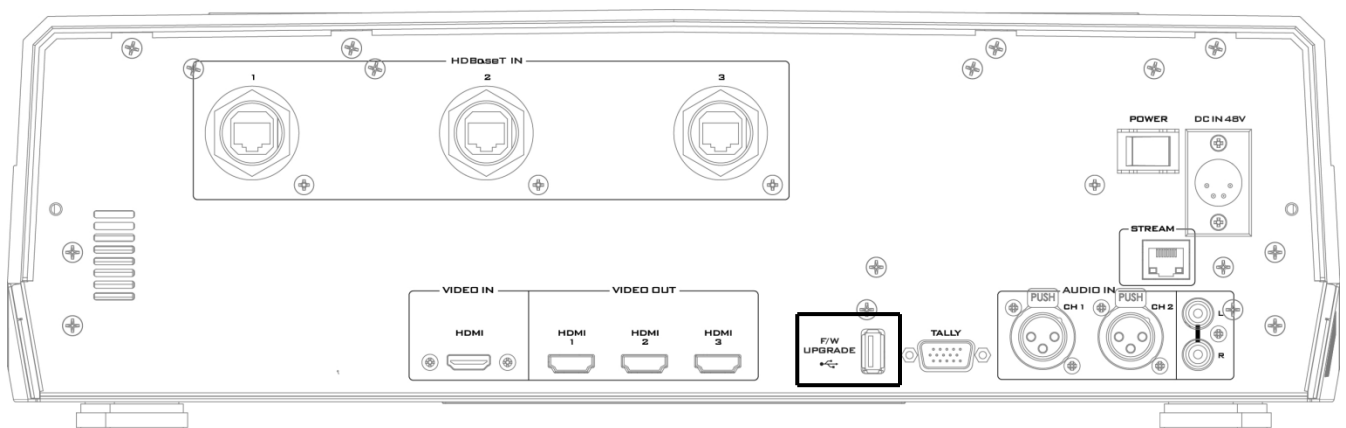

3. Turn on the HS-1600T MKII power.
4. Approximately after 5 seconds, the keyboard firmware will be updated and the update status will be indicated by the LED color of the program row buttons.
  - **Same version number** detected: The firmware will **NOT** be updated and all six buttons should



illuminate red.

- **Different version number** detected: The BLK button flashes red twice and the firmware will be updated. All six program row buttons will illuminate red while the firmware is being updated. As soon as the program row buttons are turned off and then turned back on (red) again, the firmware update is complete. The HS-1600T MKII automatically reboots itself after the keyboard firmware is updated.

5. The Mainboard firmware is automatically updated after the Step 4 is executed and the update status will be indicated by the LED color (green) of the preview row buttons. Approximately 5 seconds after the HS-1600T MKII is rebooted, you will see a startup screen on the monitor with old mainboard version (V1.5) displayed at the bottom right corner. At this point, the BLK button will start flashing green. The mainboard firmware update will start approximately 10 seconds after the mainboard finishes booting.

The startup screen on the monitor disappears and the firmware update will be in progress as the preview row buttons are turned on one at a time from left to right until all buttons illuminate solid green after approximately **ONE minute**. At this point, the firmware update is complete and the mainboard will reboot itself. After the HS-1600T MKII finishes booting, the new version number (V1.6) will be displayed at the bottom right corner of the HS-1600T MKII startup screen.

6. The OSD fonts will be automatically updated after the Step 5 is executed and the update status will be indicated by the LED color (green) of the preview row buttons. The machine reboots itself after the mainboard is updated, and the BLK button will start flashing green after the reboot. The OSD fonts update will start approximately 10 seconds after the mainboard finishes booting.

The startup screen on the monitor disappears and the firmware update will be in progress as the preview row buttons are turned on one at a time from left to right until all buttons illuminate solid green after approximately **SIX minutes**. At this point, the monitor should display a four-quadrant Multiview screen and this indicates that the OSD fonts update is complete.

7. The update is finished when all six buttons of the program and preview rows illuminate solid red and green respectively. Remove the USB thumb drive and reboot the HS-1600T MKII.
8. After the machine finishes booting and as soon as you see the Multiview screen, press the MENU button to open the OSD menu to check the MB, OSD and KB versions:  
Use the Up/Down arrow buttons to move to the Setup option and check if the firmware is successfully updated:

- MB Software: V1.16.1.02
- KBD Software: V1.2 (HS-1600T MKII)

**Note 1:** The device will not be damaged even if the USB cable or power is accidentally disconnected while the firmware is being updated; plug the USB thumb drive back in and reboot the device to resume the update process.

**Note 2:** The USB disk drive system supports FAT / FAT32 formats.

**Note 3:** There is no guarantee that the HS-1600T MKII supports all USB disks. When you see all buttons of the program and preview rows illuminate pink or greenish pink, this indicates that the disk file read error has occurred. Please try using other USB flash drive brands.

## ***Video Streaming Server***

**To update the video streaming server, you will need:**

- The latest firmware for the **video streaming server**.  
This firmware file can be obtained from your local Datavideo office or dealer or product page.
- HS-1600T MKII x 1
- 48V Power adapter x 1

### **Update Procedure**

1. Visit the official product page [https://www.datavideo.com/tw/product/HS-1600T MKII](https://www.datavideo.com/tw/product/HS-1600T%20MKII) where you can download the latest firmware file.
2. Login the NVS-31 Mark II web interface, then click the **System** tab to open the system configuration page.
3. Scroll down to **Firmware Update** then click the **Browse** button to search for the latest firmware file on the PC's hard disk.

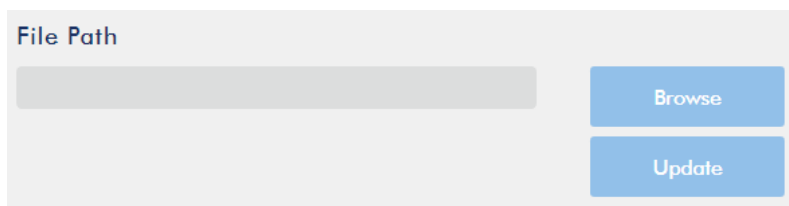

4. After double clicking the firmware file, you will see the loading prompt as shown below, indicating that the file is being uploaded to the NVS-31 Mark II.

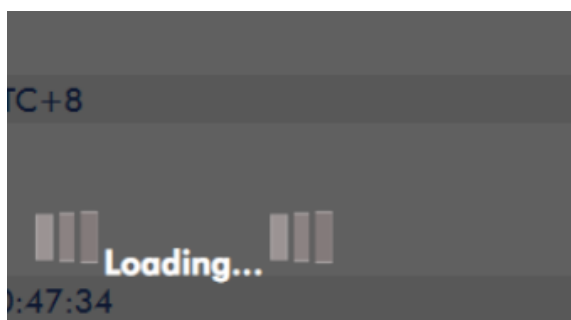

5. After the file has been successfully uploaded, you will see a file upload success message. Click the **Update** button to start the firmware update process.



6. The device will reboot itself after it is updated successfully.

**Preparing for Rebooting!**

**48 Secs**

**Note: If the device is recording or streaming, you must turn them off before initiating the firmware update.**

## Appendix 3 Recommended SD Cards

You should only use Class 10 SD card or above. In this appendix, you will find a list of SD cards recommended by Datavideo.

Recommended SD Cards			
No.	Brand	Model	Pictures
1	Kingston	SDHC I C10 16GB	
2	SANDISK Extreme	SDXC I C10 U3 V30 64GB	
3	SONY	SDXC I C10 U1 64GB	
4	SANDISK Extreme PRO	SDXC I C10 U3 128GB/64GB	 
5	SONY	SDXC I C10 U3 64GB	
6	TOSHIBA	SDHC C10 16GB	

Recommended SD Cards			
No.	Brand	Model	Pictures
7	SANDISK Extreme	SDHC C10 16GB	
8	ADATA Premier Pro	microSDXC I UHS-I U3 Class 10 with SD adapter 64GB/16GB	 
9	SANDISK ULTRA®	SDHC™/SDXC™ UHS-I 128GB	
10	Transcend	300S UHS-I SDHC 64GB/32GB	 

## Appendix 4 Frequently-Asked Questions

This section describes problems that you may encounter while using HS-1600T MKII. If you have any questions, please refer to related sections and follow all suggested solutions. If problem still exists, please contact your distributor or the service center.

No.	Problems	Solutions
1.	<b>Audio is switched only after the transition is complete.</b>	It is normal that audio is switched after the transition is complete regardless of the transition method (T-Bar or Auto) used.
2.	<b>What are the recommended SD card classes?</b>	Use any of the SD Card Classes C10/U1/V10.
3.	<b>a. Why am I still seeing lag delay in the video recorded on SD Card Class C10?</b>	a. This could be due to unoptimized disk formatting. Format your disk on the NVS-31 Mark II or using the tool downloaded from the SD association's official website ( <a href="https://www.sdcard.org/cht/downloads/formatter_4/index.html">https://www.sdcard.org/cht/downloads/formatter_4/index.html</a> ).
	<b>b. In this case, why doesn't the system issue any error messages upon start of video recording?</b>	b. The system only detects and sets write speed upon start of video recording. The system will not issue an error message if insufficient write speed is experienced while video recording is in progress.
4.	<b>Jitter is seen on moving images.</b>	Please make sure the input and output are set to the same resolution and frame rate.
5.	<b>A few important things to note about operating the NVS-31 Mark II.</b>	Because the NVS-31 Mark II UI is not updated in real time so the UI status display may not reflect the current device status. As a result, whether the device is operated on the panel, on the UI or both, please refresh the status page from time to time to make sure the information shown is the latest. You should also constantly monitor your video recording and streaming at the same time.
6.	<b>I've experienced issues with other camera functions after the PUSH AUTO key is pushed.</b>	After the PUSH AUTO key is pushed, wait for 5 to 6 seconds while the camera adjusts the white balance setting automatically then proceed to the next action.
7.	<b>Unable to update NVS-31 Mark II firmware on MAC OS.</b>	It is recommended to run NVS-31 Mark II web UI on Windows and the recommended browsers are Microsoft Edge, Google Chrome and Firefox.

## Appendix 5 Ethernet Cable Selection for HDBaseT Networks

### Tips for Setting up an HDBaseT Compliant Network

According to the HDBaseT Alliance Standards, the maximum number of cables allowed in a bundle is six. The table below summarizes the maximum number of cables allowed in a bundle based on the cable type as well as the run distance.

Type	30m	50m	70m	100m
CAT5e/6	6	4	2	1
CAT6a/7	6	6	6	6

When using CAT5e/6 cables, the following installation practices will mitigate external interferences.

1. Do not bundle the first 20 meters of cables in a horizontal cable run.
2. Avoid tight tie wraps, clamping or stapling; tie cables loosely with appropriate cable wraps.
3. Use horizontal cable management, for example, run cables connected to odd ports of the Ethernet switch through the cable manager above and cables connected to even ports of the Ethernet switch through the cable manager below.
4. Lay loose vertically run cables.
5. Reduce the fill ratio capacity of the conduit to 40%.
6. It is recommended to wrap the cable around a cable reel as shown on the left of the diagram below. Compared to loosely laid cables, cables wrapped up in a reel generate substantially lower electromagnetic fields. Compared to a fully stretched cable, it has been tested and proven that cables wrapped up in a cable reel with a diameter of 70 cm experience only slight signal degradation due to noise.



### Tips for Setting up an HDBaseT Compliant Network in a Noisy Environment

1. For an outdoor HDBaseT Compliant Network, it is recommended to use UV resistant Ethernet cables to ensure connection quality. UV resistant Ethernet cables are usually coated with black PE jacket.
2. Use SFTP\* Ethernet cables if your network environment contains multiple interference sources.

\*SFTP stands for Shielded with Foiled Twisted Pairs; the individual twisted pairs are wrapped in a foil tape before being wrapped in an overall flexible yet mechanically strong braid screen. The additional foil on the twisted pairs helps to reduce crosstalk from adjacent pairs and other cables. The braid provides better grounding.

### Tips for the Ethernet Cable Selection

1. Use solid Ethernet cables for better electrical performance.



2. Round Ethernet cables are preferred over the flat ones because they deliver better quality with higher durability, security and clarity in signal communication.

3. Visit the website "<http://hdbaset.org/hdbaset-recommended-cables/>" for the list of all the HDBaseT Alliance verified Ethernet cable providers.

4. For more information about how to set up an HDBaseT network, visit the website "<http://hdbaset.org/installers/>" and sign up for free membership.



## Appendix 6 Dimensions

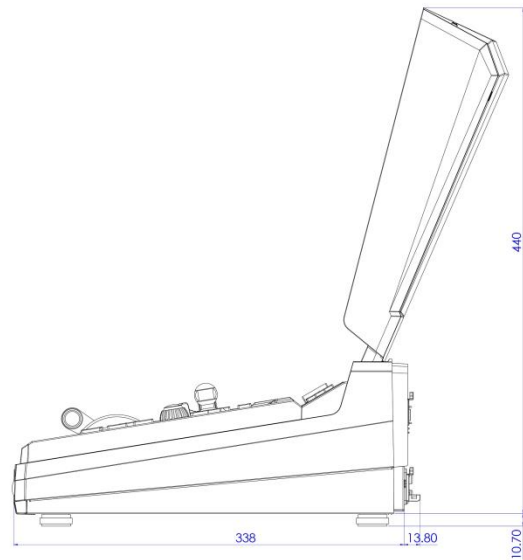
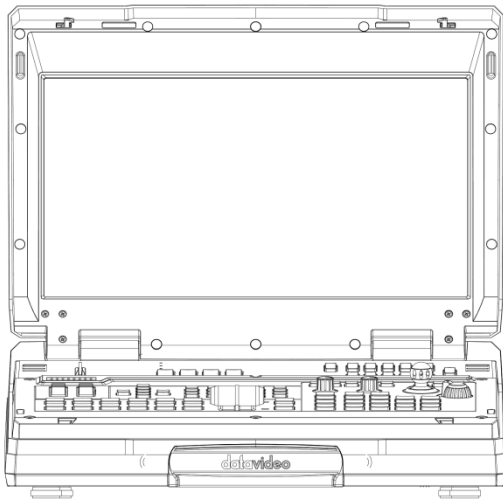
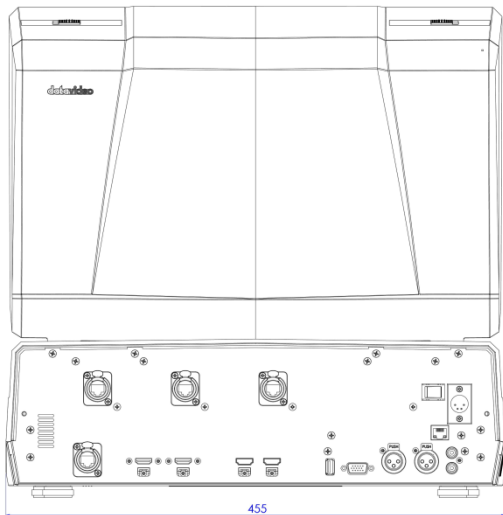

All measurements in millimeters (mm)

## Appendix 7 Specifications

<b>Model Name</b>	<b>HS-1600T MKII</b>
<b>Product Name</b>	4-Channel HD/SD HDBaseT Portable Video Streaming Studio
<b>Video Standard</b>	HD & SD
<b>Video Format</b>	1080p 50/59.94/60Hz 1080i 50/59.94/60Hz 720p 50/59.94/60Hz 576i/p 50Hz 480i/p 59.94Hz
<b>Input Routable / Crosspoint</b>	N/A
<b>Video Input</b>	3 x HDBaseT 1 x HDMI
<b>Computer Graphical Interface</b>	1 via HDMI
<b>Down-Converted Output</b>	Yes
<b>Video Output</b>	3 x HDMI PGM 1 x HDBaseT (RJ-45) 1 x Stream Port (RJ-45)
<b>Analogue Audio Input</b>	2 x Balanced XLR 1 x Stereo RCA (L/R) De-embedded Digital Audio
<b>Analogue Audio Output</b>	1x Stereo headphone
<b>Digital Embedded Audio Support</b>	Input :2 Channel Output: 2 Channel
<b>Audio Delay Calibration</b>	N/A
<b>A+V Switching</b>	N/A
<b>USK</b>	1x USK Lumakey support
<b>DSK</b>	N/A
<b>Picture in Picture</b>	1
<b>Logo Insertion</b>	N/A
<b>Built-in Audio Mixer</b>	Yes, 4 Channels
<b>Built-in Monitor Display</b>	17.3" HD TFT LED backlit, 1920x1080 pixels
<b>Built-in Intercom &amp; Tally</b>	N/A
<b>Streaming Video Encode</b>	H.264 / AVC, Main/ High Profile Configurable Bit-rate up to 10Mbps

<b>Model Name</b>	<b>HS-1600T MKII</b>
<b>Product Name</b>	4-Channel HD/SD HDBaseT Portable Video Streaming Studio
<b>Streaming Audio Encode</b>	AAC-LC Configurable bit rate ranging from 32Kbps to 384Kbps Sample rate: 48KHz, 16bit
<b>Streaming Protocol</b>	TS over TCP/UDP (unicast & multicast) RTSP over HTTP/TCP/UDP (RTSP Elementary Streaming) RTMP/RTMPS (Publish) HLS SRT
<b>Streaming Control</b>	Web browser UI for configuration and control Socket commands
<b>Recording File System</b>	FAT, exFAT, NTFS
<b>Recording File Format</b>	MP4
<b>Recording Setting Control</b>	Web UI for system configuration and control
<b>Dimensions (LxWxH)</b>	455 x 355 x 134 mm
<b>Weight</b>	17.2 Lbs (7.8 Kg), Reinforce Plastic Case
<b>Accessory</b>	CB-60/61/62

# Service & Support

It is our goal to make owning and using Datavideo products a satisfying experience. Our support staff is available to assist you to set up and operate your system. Contact your local office for specific support requests. Plus, please visit [www.datavideo.com](http://www.datavideo.com) to access our FAQ section.

Please visit our website for latest manual update.

[www.datavideo.com/product/HS-1600T MARK II](http://www.datavideo.com/product/HS-1600T_MARK_II)

**datavideo**  
[www.datavideo.com](http://www.datavideo.com)



@DatavideoUSA @DatavideoIndia2016  
@DatavideoEMEA @Datavideojapan  
@DatavideoTaiwan @DatavideoLatam  
@DatavideoAsia @DatavideoBrasil



@Datavideo  
@Datavideo\_EMEA  
@Datavideo\_Taiwan



@DatavideoUSA  
@DVTWDCVN



@DatavideoUSA  
@DatavideoEurope

All the trademarks are the properties of their respective owners.  
Datavideo Technologies Co., Ltd. All rights reserved 2020

Apr-28.2021  
Version E9