

POWER AMPLIFIER

**PX10/PX8
PX5/PX3**

Owner's Manual

Thank you for your purchase of the Yamaha PX10, PX8, PX5 or PX3 power amplifier. Please read through this manual carefully before using for the first time, in order to take full advantage of your PX power amplifier's superlative features and enjoy trouble-free operation for years to come. After you have read the manual, keep it in a safe, convenient place for reference when needed.

- Please read the PRECAUTIONS on the reverse side of this manual before use.
- The illustrations as shown in this manual are for instructional purposes only.
- The company names and product names used in this manual are the trademarks or registered trademarks of their respective companies.
- In this manual, the PX10, PX8, PX5 and PX3 power amplifier models are referred to collectively as "PX amplifier."
- Unless specified otherwise, the example illustrations used in this manual are taken from the PX10.
- The PX amplifier provides two setting methods: Basic mode and Advanced mode. This manual explains operations in the Basic mode. Operate in the Advanced mode for detailed settings. For information on the Advanced mode, refer to the PX10/PX8/ PX5/PX3 Reference Manual.

The PX10/PX8/ PX5/PX3 Reference Manual is an electronic file in PDF format. You can read this book on a computer. Use Adobe® Reader® to read this book on screen, search for words very quickly, print specific pages, or click links to display sections of special interest. The ability to search for words, or to follow links directly to relevant sections in the document, are helpful attributes of this electronic file format. We encourage you to take advantage of these benefits. You can download the latest Adobe Reader application from the website listed below.
<http://www.adobe.com/>

Features

- Maximum output of 1,000W out of lightweight chassis (PX10)
- Yamaha's proprietary Class-D and processing technologies provide superb sound quality and high reliability
- Speaker presets that allow you to get the best possible performance from Yamaha speakers
- A wide variety of DSP functions, including D-CONTOUR processing
- CONFIG WIZARD that provides the optimal configuration for any speaker
- Broad range of input/output connectors

Included accessories

- AC power cord
- Owner's Manual (this leaflet)
- Technical Specifications (English)
- AC plug clamp
- USB cap

Setup

The PX amplifier can be used as a normal amplifier by simply setting the volume knobs properly. The following settings enhance the performance of speakers.

Pre-installation

Mount PX amplifiers in a rack as required. Make sure that the power is turned off, and turn both the two volume knobs all the way to the left.

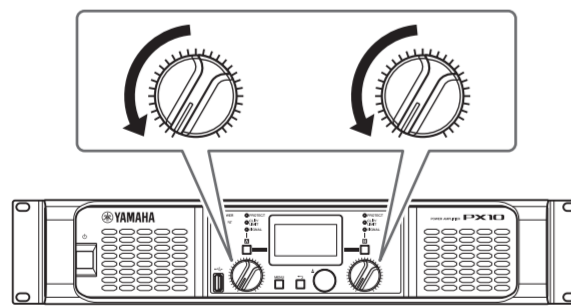

In this manual, methods of operations are explained with the following marks.

— [(item name)]: Rotate the main knob to select [(item name)].

: Press the Main knob.

: Press the [MENU] key.

: Press the [←] (back) key.

A → B : Operate A, and then operate B.

A solid arrow (↓) between steps indicates a basic operation procedure, and a dotted arrow (↑) indicates an operation returning to the previous screen.

Stereo connection (using two full-range speakers)

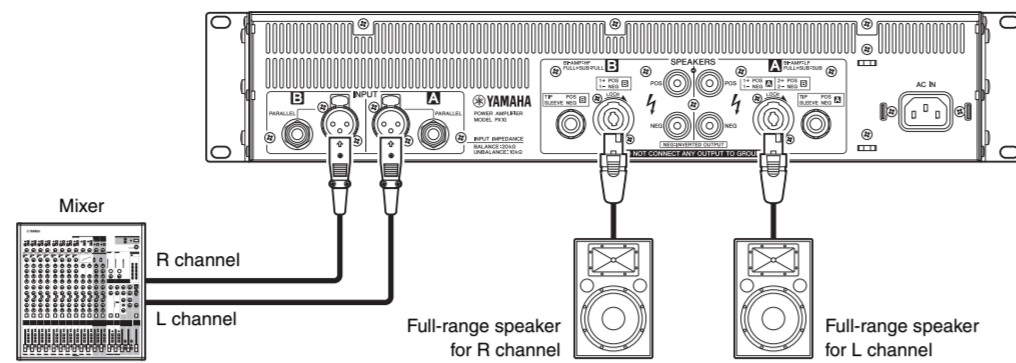

CAUTION
Please carry out "Pre-installation" surely. Do not connect any cables while the power is on.

1. Connect the full-range speaker for L channel to the [SPEAKERS] A terminal and the full-range speaker for R channel to the [SPEAKERS] B terminal.
2. Connect the output from sources (such as a mixer) to the [INPUT] A/B connectors. Connect the L channel source to the [INPUT] A connector, and the R channel source to the [INPUT] B connector.
3. Connect the AC power cord and turn on. First connect the AC power cord to the connector on the unit, and then plug it into an appropriate AC power outlet.
4. Secure the AC power cord with the AC plug clamp to prevent accidental disconnection from the connector. Refer to the "Rear panel" section on the reverse side for instructions on installation.

NOTE
Refer to the "Wiring" section on the reverse side for instructions on making connections.

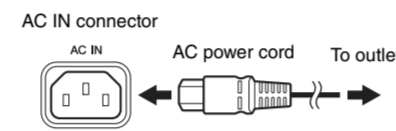

Cross-over connection (using a full-range speaker and a subwoofer)

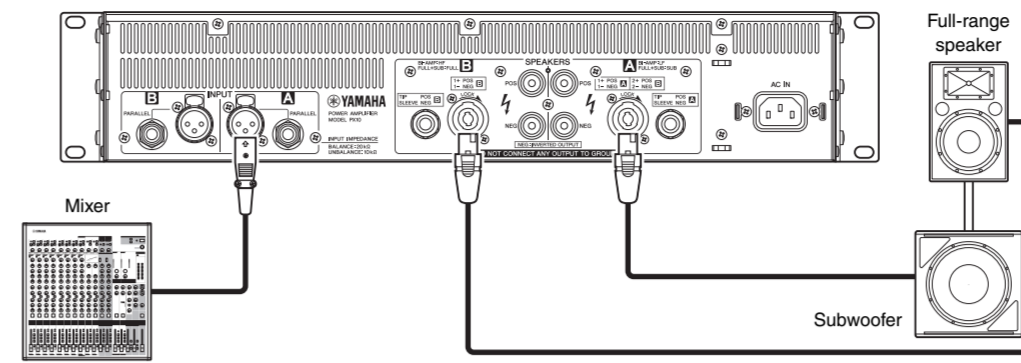

CAUTION
Please carry out "Pre-installation" surely. Do not connect any cables while the power is on.

1. Connect the subwoofer to the [SPEAKERS] A terminal and the full-range speaker to the [SPEAKERS] B terminal.
2. Connect the output from source (such as mixer) to the [INPUT] A connector.
3. Connect the AC power cord and turn on. First connect the AC power cord to the connector on the unit, and then plug it into an appropriate AC power outlet.
4. Secure the AC power cord with the AC plug clamp to prevent accidental disconnection from the connector. Refer to "Rear panel" section on the reverse side for instructions on the installation.

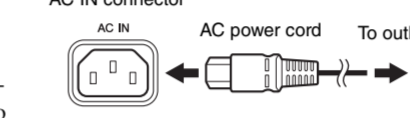

HOME screen

→ **MENU screen (top screen)**

→ **SP TYPE screen**

→ **Speaker selection (A)**

→ **HPF screen**

→ **Speaker selection (B)**

→ **X-OVER screen**

→ **CONFIRMATION screen**

→ (Applies the set value) → Go on to the "Tone control" instructions.

Tone Control

Input signal from the source, confirm that the sound is being output from the speakers, and adjust the volume appropriately.

→ **TUNING screen**

→ **D-CONTOUR screen**

→ **MODE Selection screen**

→ **DEPTH Selection screen**

→ **MENU screen (top screen)**

→ **HOME screen**

- NOTE**
- To mute channel A, push the [A] key and the main knob simultaneously. To cancel muting, push the [A] key and the main knob simultaneously again.
 - To mute channel B, push the [B] key and the main knob simultaneously. To cancel muting, push the [B] key and the main knob simultaneously again.

Controls and Functions

Front panel

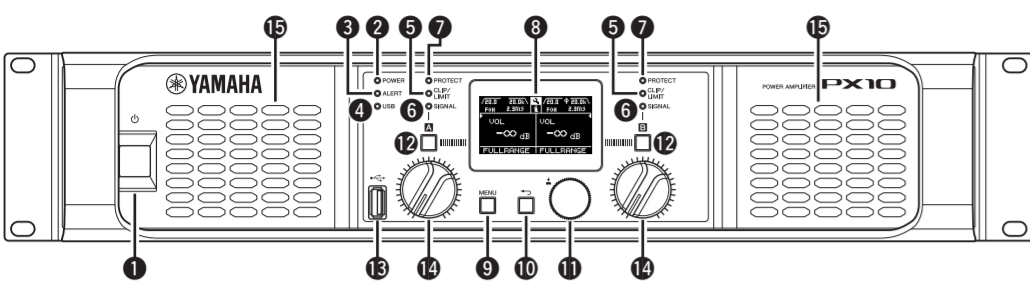

1 Power button

Turns the power to the unit on or off.

2 [POWER] indicator

Turns on when the power is on.

3 [ALERT] indicator

Lights when a problem in the device is detected. Lights until the cause of the problem is solved.

NOTE

Details of the problem are shown on the display (17). Selecting the  icon on the HOME screen with the main knob calls up the operating log.

17 icon

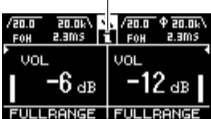

4 [USB] indicator

Lights when a compatible USB memory device is inserted into the [USB] terminal. Flashes when the USB device is being accessed.

NOTICE

Do not unplug the USB device while the [USB] indicator is flashing. Data in the USB memory may be corrupted or lost.

5 [CLIP/LIMIT] indicators

Lights when the limiter is operating to protect the amplifier and the speaker, or the input signal overflows in the digital circuit or clips at the amplifier output.

6 [SIGNAL] indicators

Lights when the output is larger than -60 dB of maximum output level (8 ohms).

7 [PROTECT] indicators

Lights when the protection circuit is operating.

8 Display

Displays condition of the PX amplifier and setting menus.

9 [MENU] key

Press the key to move to the top MENU screen.

10 [←→] (Back) key

Press this key to move up to the immediately higher menu level or previous display. Press and briefly hold the key to return the HOME screen.

11 Main knob

Rotate the knob to change the values of parameters and move the position of cursor. Press the knob to actually enter the set value or enable the selected item.

12 [A]/[B] keys

Press the key to switch the channel (A or B) for operating the corresponding parameters.

NOTE

Press the main knob and [A] key to change the mute status of channel A. Press the main knob and [B] key to change the mute status of channel B.

13 [USB] terminal

Insert a USB memory device to read/load the data from/to the PX amplifier.

NOTICE

When the terminal is not used, attach the supplied USB cap to protect the terminal.

14 Volume knob

Adjust the level from -∞ dB to 0 dB.

15 Intake ports

Air intakes for the cooling fan. Make sure to not block the air intakes.

NOTE

- The settings can be changed so that the display and indicators turn off automatically when panel is not operated (Black-out mode). Refer to PX10/PX8/PX5/PX3 Reference Manual for instructions on the Black-out mode.

- For the protection of the display, even if the Black-out mode is not active, the display automatically turns off if the PX amplifier has not been operated for 20 minutes. To turn on the display again, simply press any key on the front panel or rotate the main knob.

Rear panel

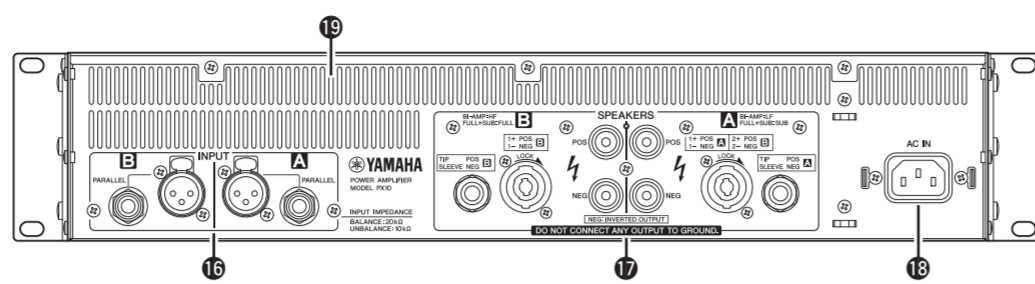

16 [INPUT] A/B connectors

The following two type input connectors are provided for both channels A and B.

- XLR input jack
- Phones input jack

NOTE

Each XLR input jack and phones input jack are connected in parallel. Only one of the jacks can be used as an input jack at one time; the signals from the jacks cannot be mixed.

17 [SPEAKERS] A/B terminals

Output terminals to speakers. The following three types are available:

- Neutrik NL4MD SpeakON output connector
- Binding post output connector
- Phones output jack

CAUTION
Do not touch the terminals or metal parts of cords connected to the terminal.

NOTICE

- If connecting speakers to multiple connectors of a same channel results in a parallel connection, make sure that the total impedance of the speakers to be connected is not excessively low.
- The PX amplifier adopts BTL (Balanced Transformer Less) amplifier circuits. Connecting both terminals of channels A and B and contact between the terminal and the chassis may cause a failure or malfunction. Be careful to not connect or contact the two by mistake.

■ Wiring

● Binding post connector

• No plugs

Remove about 15 mm of insulation from the end of each speaker cable, pass the bare wire through the holes in the appropriate speaker terminals, and tighten the terminals to securely clamp the wires. Make sure that the bare wire ends do not jut out from the terminals and touch the chassis.

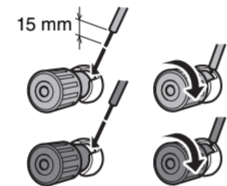

• Y-plugs

From above, insert the Y-plugs all the way into the opening, and tighten the terminals.

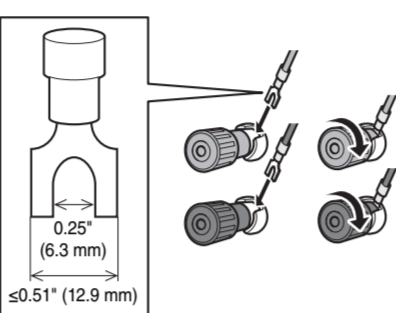

● SpeakON connector

Insert the SpeakON cable plug (Neutrik NL4) into the connector, and turn it to the right to lock it.

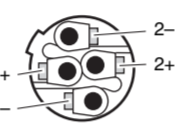

Channel A

Neutrik NL4	PX amplifier	Channel B	Neutrik NL4	PX amplifier
1+	A+	1+	B+	B+
1-	A-	1-	B-	B-
2-	B-	2+	(not connected)	
2-	B-	2-	(not connected)	

18 AC IN connector

Connect the supplied AC power cord. First connect the AC power cord to the connector on the amplifier, and then plug it into an appropriate AC power outlet. Secure the AC power cord with the AC plug clamp to prevent accidental disconnection from the connector.

Installing the AC plug clamp

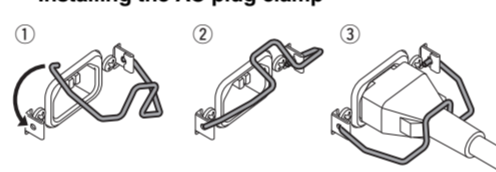

19 Exhaust ports

Exhaust vents for the cooling fan. Make sure to not block the exhaust vents.

PRECAUTIONS

PLEASE READ CAREFULLY BEFORE PROCEEDING

Please keep this manual in a safe place for future reference.

WARNING

Always follow the basic precautions listed below to avoid the possibility of serious injury or even death from electrical shock, short-circuiting, damages, fire or other hazards. These precautions include, but are not limited to, the following:

Power supply/power cord

- Do not place the power cord near heat sources such as heaters or radiators, and do not excessively bend or otherwise damage the cord, place heavy objects on it, or place it in a position where anyone could walk on, trip over, or roll anything over it.
- Only use the voltage specified as correct for the device. The required voltage is printed on the name plate of the device.
- Only use the supplied power cord/plug.
- Check the electric plug periodically and remove any dirt or dust which may have accumulated on it.
- When setting up the device, make sure that the AC outlet you are using is easily accessible. If some trouble or malfunction occurs, immediately turn off the power switch and disconnect the plug from the outlet. Even when the power switch is turned off, as long as the power cord is not unplugged from the wall AC outlet, the device will not be disconnected from the power source.
- Remove the electric plug from the outlet when the device is not to be used for extended periods of time, or during electrical storms.
- Be sure to connect to an appropriate outlet with a protective grounding connection.

Do not open

This device contains no user-serviceable parts. Do not open the device or attempt to disassemble the internal parts or modify them in any way. If it should appear to be malfunctioning, discontinue use immediately and have it inspected by qualified Yamaha service personnel.

Water warning

- Do not expose the device to rain, use it near water or in damp or wet conditions, or place on it any containers (such as vases, bottles or glasses) containing liquids which might spill into any openings. If any liquid such as water seeps into the device, turn off the power immediately and unplug the power cord from the AC outlet. Then have the device inspected by qualified Yamaha service personnel.
- Never insert or remove an electric plug with wet hands.

Hearing loss

- Do not use speakers for a long period of time at a high or uncomfortable volume level, since this can cause permanent hearing loss. If you experience any hearing loss or ringing in the ears, consult a physician.
- When turning on the AC power in your audio system, always turn on the device LAST, to avoid hearing loss and speaker damage. When turning the power off, the device should be turned off FIRST for the same reason.

Fire warning

- Do not place any burning items or open flames near the device, since they may cause a fire.

If you notice any abnormality

- If any of the following problems occur, immediately turn off the power switch and disconnect the electric plug from the outlet.

- The power cord or plug becomes frayed or damaged.
- Unusual smells or smoke are emitted.
- Some object has been dropped into the device.
- There is a sudden loss of sound during use of the device.
- Cracks or other visible damage appear on the device.
- Then have the device inspected or repaired by qualified Yamaha service personnel.

• If this device should be dropped or damaged, immediately turn off the power switch, disconnect the electric plug from the outlet, and have the device inspected by qualified Yamaha service personnel.

CAUTION

Always follow the basic precautions listed below to avoid the possibility of physical injury to you or others, or damage to the device or other property. These precautions include, but are not limited to, the following:

Power supply/power cord

- When removing the electric plug from the device or an outlet, always hold the plug itself and not the cord. Pulling by the cord can damage it.

Location

- Do not place the device in an unstable position where it might accidentally fall over and cause injuries.
- Do not block the vents. This device has ventilation holes at the front/rear to prevent the internal temperature from becoming too high. In particular, do not place the device on its side or upside down. Inadequate ventilation can result in overheating, possibly causing damage to the device(s), or even fire.
- When installing the device:
 - Do not cover it with any cloth.
 - Do not install it on a carpet or rug.
 - Make sure the top surface faces up; do not install on its sides or upside down.
 - Do not use the device in a confined, poorly-ventilated location.
- Inadequate ventilation can result in overheating, possibly causing damage to the device(s), or even fire. Make sure that there is adequate space around the device: at least 40 cm above, 10 cm at the sides and 10 cm behind.

- Do not place the device in a location where it may come into contact with corrosive gases or salt air. Doing so may result in malfunction.
- Keep the device out of reach of children, to keep them from putting their fingers into openings on the equipment and accidentally being injured.
- Before moving the device, remove all connected cables.
- If the device is mounted in an EIA standard rack, carefully read the section "Rack Mounting" in the PX10/PX8/PX5/PX3 Reference Manual. Inadequate ventilation can result in overheating, possibly causing damage to the device(s), malfunction, or even fire.

Connections

- Before connecting the device to other devices, turn off the power for all devices. Also, before turning the power of all devices on or off, make sure that all volume levels are set to the minimum. Failing to do so may result in electric shock, hearing loss, or equipment damage.
- Use only speaker cables for connecting speakers to the speaker jacks. Use of other types of cables may result in fire.

Maintenance

- Remove the power plug from the AC outlet when cleaning the device.

Handling caution

- Do not insert your fingers or hands in any gaps or openings on the device (vents).
- Avoid inserting or dropping foreign objects (paper, plastic, metal, etc.) into any gaps or openings on the device (vents). If this happens, immediately turn off the power unplug the power cord from the AC outlet, and have the device inspected by qualified Yamaha service personnel.
- Do not rest your weight on the device or place heavy objects on it, and avoid use excessive force on the buttons, switches or connectors to prevent injuries.

Yamaha cannot be held responsible for damage caused by improper use or modifications to the device, or data that is lost or destroyed.

PA_en_7

IMPORTANT NOTICE FOR THE UNITED KINGDOM

Connecting the Plug and Cord
WARNING: THIS APPARATUS MUST BE EARTHED IMPORTANT. The wires in this mains lead are coloured in accordance with the following code:

- GREEN-AND-YELLOW : EARTH
- BLUE : NEUTRAL
- BROWN : LIVE

As the colours of the wires in the mains lead of this apparatus may not correspond with the coloured markings identifying the terminals in your plug proceed as follows:

The wire which is coloured GREEN-AND-YELLOW must be connected to the terminal in the plug which is marked by the letter E or by the safety earth symbol  or coloured GREEN or GREEN-AND-YELLOW.

The wire which is coloured BLUE must be connected to the terminal which is marked with the letter N or coloured BLACK. The wire which is coloured BROWN must be connected to the terminal which is marked with the letter L or coloured RED.

(3 wires)

Information for Users on Collection and Disposal of Old Equipment

This symbol on the products, packaging, and/or accompanying documents means that used electrical and electronic products should not be mixed with general household waste. For proper treatment, recovery and recycling of old products, please take them to applicable collection points, in accordance with your national legislation and the Directives 2002/96/EC.

By disposing of these products correctly, you will help to save valuable resources and prevent any potential negative effects on human health and the environment which could otherwise arise from inappropriate waste handling.

For more information about collection and recycling of old products, please contact your local municipality, your waste disposal service or the point of sale where you purchased the items.

[For business users in the European Union]
If you wish to discard electrical and electronic equipment, please contact your dealer or supplier for further information.

[Information on Disposal in other Countries outside the European Union]
This symbol is only valid in the European Union. If you wish to discard these items, please contact your local authorities or dealer and ask for the correct method of disposal.

(weee_eu_en_01)

ADDRESS LIST

NORTH AMERICA		MALTA		OTHER COUNTRIES	
CANADA Yamaha Canada Music Ltd. 135 Milner Avenue, Toronto, Ontario, M1S 3R1, Canada Tel: +1-416-298-1311		Olimpus Music Ltd. Valletta Road, Mosta MST9010, Malta Tel: +356-2133-2021, 2022 Jebel Ali FZE, Dubai, UAE Tel: +971-4-801-1500		Yamaha Music Gulf FZE JAFZA-16, Office 512, P.O. Box 17328, Jebel Ali FZE, Dubai, UAE Tel: +971-4-801-1500	
U.S.A. Yamaha Corporation of America 6600 Orangeflora Avenue, Buena Park, CA 90620, U.S.A. Tel: +1-714-522-9011		Clarissenhof 5b, 4133 AB Vianen, The Netherlands Tel: +31-347-358040		CHINA Yamaha Music & Electronics (China) Co., Ltd. 2F, Yunhedasha, 1818 Xinxin-lu, Jingan-qu, Shanghai, China Tel: +86-400-051-7700	
CENTRAL & SOUTH AMERICA MEXICO Yamaha de México, S.A. de C.V. Av. Insurgentes Sur 1647 Piso 9, Col. San José Insurgentes, Delegación Benito Juárez, México, D.F. C.P. 03900 Tel: +52-55-5804-0600		LUXEMBOURG Yamaha Music Europe Branch Benelux Clarissenhof 5b, 4133 AB Vianen, The Netherlands Tel: +31-347-358040		INDIA Yamaha Music India Private Limited Spazeed Building, Ground Floor, Tower A, Sector-47, Gurgaon- Sohna Road, Gurgaon-122002, Haryana, India Tel: +91-124-485-3300	
ARGENTINA Yamaha Musical del Brasil Ltda. Rua Fidêncio Ramos, 302 - CJ 52 e 54 - Torre B - Vila Olímpia - CEP 04551-010 - São Paulo/SP, Brazil Tel: +55-11-3704-1377		FRANCE Yamaha Music Europe 7 rue Ambroise Croizat, Zone d'activités de Pariset, 77183 Crossy-Beaubourg, France Tel: +33-1-6461-4000		INDONESIA PT. Yamaha Musik Indonesia (Distributor) Yamaha Music Center Bldg. Jani Jend. Gatot Subroto Kav. 4, Jakarta 12930, Indonesia Tel: +62-21-520-2577	
ITALY Yamaha Music Europe GmbH, Branch Italy Viale Italia 88, 20020, Lainate (Milano), Italy Tel: +39-02-93577-1		NETHERLANDS/BELGIUM/ Clarissenhof 5b, 4133 AB Vianen, The Netherlands Tel: +31-347-358040		SPAIN/PORTUGAL Yamaha Music Europe GmbH Ibérica, Sucursal en España Ctra. de la Corona km. 17,200, 28231 Las Rozas de Madrid, Spain Tel: +34-91-639-88-88	
ARGENTINA Yamaha Musical de Venezuela, C.A. Av. Manzanares, C.C. Manzanares Plaza, Piso 4, Oficina 0401, Baruta, Caracas, Venezuela Tel: +58-212-943-1877		GERMANY Philippos Nakas S.A. The Music House 19th Km. Leof. Lavriou 190 02 Peania - Attiki, Greece Tel: +30-210-6686168		TAIWAN Yamaha Music & Electronics Taiwan Co., Ltd. 2F, No. 1, Yuandong Rd. Banqiao Dist. New Taipei City 22063, Taiwan, R.O.C. Tel: +886-2-7741-8888	
ARGENTINA Olga Cossetini 1553, Piso 4 Norte, Maduro Este-C1107CEK, Buenos Aires, Argentina Tel: +54-11-4119-7000		GERMANY YA Wettergengsgata 1, 400 43 Göteborg, Sweden Tel: +46-31-89-34-00		THAILAND Siam Music Yamaha Co., Ltd. 3, 4, 15, 16th Fl., Siam Motors Building, 891/1 Rama 1 Road, Wangmai, Pathumwan, Bangkok 10330, Thailand Tel: +66-2215-2622	
PANAMA AND OTHER LATIN AMERICAN COUNTRIES/ CARIBBEAN COUNTRIES Yamaha Music Latin America, S.A. Edif: Torre Banco General, Piso 7, Urbanización Marbella, Calle 47 y Aguilón de la Guardia, Ciudad de Panamá, República de Panamá Tel: +507-269-5311		GERMANY Yamaha Music Europe GmbH Siemensstrasse 22-34, 25462 Rellingen, Germany Tel: +49-4101-303-0		VIETNAM Yamaha Music Vietnam Company Limited 15th Floor, Nam A Bank Tower, 201-203 Cach Mang Thang Tam St., Ward 4, Dist. 3, Ho Chi Minh City, Vietnam Tel: +84-8-3818-1122	
DENMARK Yamaha Music Denmark, Filial of Yamaha Music Europe GmbH, Tyskland Generatorvej 8C, ST. TH., 2860 Soborg, Denmark Tel: +45-44-92-49-00		GERMANY Yamaha Music Europe GmbH Siemensstrasse 22-34, 25462 Rellingen, Germany Tel: +49-4101-303-0		OTHER ASIAN COUNTRIES Sales & Marketing Division Yamaha Music Gulf FZE JAFZA-16, Office 512, P.O. Box 17328, Jebel Ali FZE, Dubai, UAE Tel: +971-4-801-1500	
GERMANY Yamaha Music Europe GmbH Siemensstrasse 22-34, 25462 Rellingen, Germany Tel: +49-4101-303-0		RUSSIA Yamaha Music (Russia) LLC. Room 37, entrance 7, bld. 7, Kievskaya street, Moscow, 121059, Russia Tel: +7-495-626-5005		AUSTRALIA Yamaha Music Australia Pty. Ltd. Level 19, Queensbridge Street, Southbank VIC 3006, Australia Tel: +61-3-9693-5111	
GERMANY Yamaha Music Europe GmbH Siemensstrasse 22-34, 25462 Rellingen, Germany Tel: +49-4101-303-0		SWITZERLAND/LIECHTENSTEIN Yamaha Music Europe GmbH, Rellingen. Branch Switzerland in Zürich Seefeldstrasse 94, 8008 Zürich, Switzerland Tel: +41-44-3878080		OTHER EUROPEAN COUNTRIES Yamaha Music Europe GmbH Siemensstrasse 22-34, 25462 Rellingen, Germany Tel: +49-4101-303-0	
AUSTRIA/BULGARIA Yamaha Music Europe GmbH Branch Austria Schleiergasse 20, 1100 Wien, Austria Tel: +43-1-60203900		NETHERLANDS Yamaha Music Europe GmbH Clarissenhof 5b, 4133 AB Vianen, The Netherlands Tel: +31-347-358040		CYPRUS Yamaha Music Europe GmbH Siemensstrasse 22-34, 25462 Rellingen, Germany Tel: +49-4101-303-0	
CZECH REPUBLIC/HUNGARY/ ROMANIA/SLOVAKIA/SLOVENIA Yamaha Music Europe GmbH Branch Austria Schleiergasse 20, 1100 Wien, Austria Tel: +43-1-60203900		POLAND/LITHUANIA/LATVIA/ ESTONIA Yamaha Music Europe GmbH Sp.z o.o. Oddział w Polsce ul. Wroclawska 14, 02-553 Warsaw, Poland Tel: +48-22-880-08-88		NEW ZEALAND Yamaha Music New Zealand Ltd. Unit 1, 200-225 The Esplanade, Manukau City, Auckland Tel: +64-9-480-1500	
GERMANY Yamaha Music Europe GmbH Siemensstrasse 22-34, 25462 Rellingen, Germany Tel: +49-4101-303-0		TURKEY Yamaha Music Europe GmbH Merkez Almanyana Türkiye Istanbul Subesi Maslak Mevdan Sokak, Spring Giz Plaza Bagimsiz Bol. No:3, Sariyer Istanbul, Turkey Tel: +90-212-999-8010		OTHER ASIAN COUNTRIES Sales & Marketing Division Yamaha Music Gulf FZE JAFZA-16, Office 512, P.O. Box 17328, Jebel Ali FZE, Dubai, UAE Tel: +971-4-801-1500	

PA42 HEAD OFFICE Yamaha Corporation, Audio Products Sales and Marketing Division
 10-1, Nakazawa-cho, Naka-ku, Hamamatsu, Japan 430-8650

Yamaha Pro Audio global website
<http://www.yamahaproaudio.com/>
 Yamaha Downloads
<http://download.yamaha.com/>

Manual Development Group
 © 2016 Yamaha Corporation
 Published 04/2016 POHD-B0
 Printed in China

Troubleshooting

The Yamaha Pro Audio website provides a FAQ (a list of frequently asked questions, with answers).

<http://www.yamahaproaudio.com/>