

# ETX-15SP

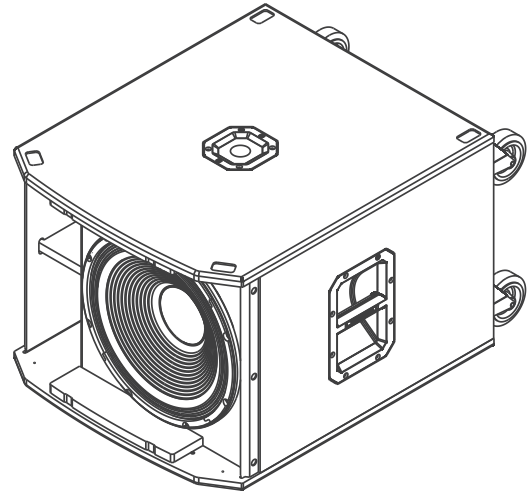

- 1800 W amplifier and 134 dB peak SPL
- Single-knob DSP includes presets for multiple configurations and top+sub combinations (performance style, locations, and space)
- Loudspeaker system performance monitoring via integrated LCD and front panel LED
- Includes DSP preset for true cardioid performance
- Enclosure includes removable casters and a combo pole cup (insert and threaded) for use with the two-way models



ETX-15SP from Electro-Voice is a powered subwoofer; it can be used in a variety of portable and permanent applications. The DSP (Digital Signal Processing) menus offer extensive configurations, crossovers, true cardioid presets, protection limiters, EQ mode, and a lock out mode that prevents casual changes to the system. Loudspeaker system performance is optimized via an LCD screen. The front LED indicates power or can be configured to indicate limit.

EV's FIR-Drive technology utilized the latest FIR (Finite Impulse Response) filter technology to optimize transducer linearity and advanced limiter algorithms for independent peak and thermal transducer protection. True cardioid DSP preset delivers true cardioid response across all frequencies.

The enclosure is constructed out of 18-mm, 13-ply birch plywood finished with EVCoat. Subwoofers include professional-grade castors, and combination pole mount receptacle for threaded and unthreaded loudspeaker poles.

ETX Powered Loudspeakers combine EV-engineered intelligent DSP, high-powered amplifiers and high-efficiency transducers to deliver that legendary EV sound and performance.

## Technical specifications

Frequency Response (-3 dB): 37 Hz – 150 Hz<sup>1</sup>

Frequency Range (-10 dB): 32 Hz – 180 Hz<sup>1</sup>

Maximum SPL: 134 dB peak<sup>2</sup>

Power Rating:	1800 W
LF Transducer:	DVX3159A 380 mm (15 in)
Low Pass Frequency:	Adjustable: 80 Hz, 100 Hz, 120 Hz, 150 Hz
Connectors:	(2) XLR/TRS Combo Jack and (2) XLR link Output
Enclosure:	18 mm, 13-ply birch plywood with EVCoat
Grille:	16AWG steel with powdercoat
Dimensions (H x W x D):	471 mm x 576 mm x 825 mm (19 in x 23 in x 32 in)
Dimensions (H x W x D): without casters	471 mm x 576 mm x 692 mm (19 in x 23 in x 27 in)
Net Weight:	41.7 kg (91.9 lb)
Shipping Weight:	46.8 kg (103.2 lb)
Power Consumption:	100 – 240 V~, 50 – 60 Hz, 1.6 – 0.8 A <sup>3</sup>

1. Half space measurement using the music DSP preset and 150 Hz low pass.
2. Maximum SPL is measured at 1 m using broadband pink noise at maximum amplifier output.
3. Current rating is 1/8 power.

# System overview

## Dimension drawing:

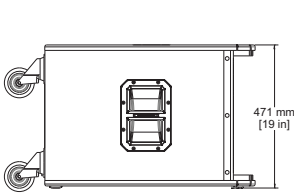

Left View

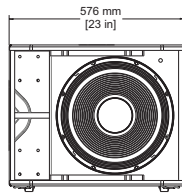

Front View

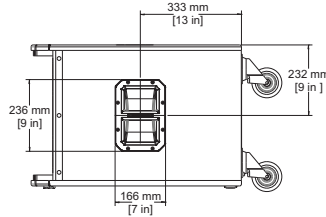

Right View

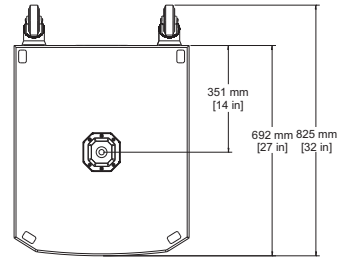

Top View

## Subwoofer amplifier panel:

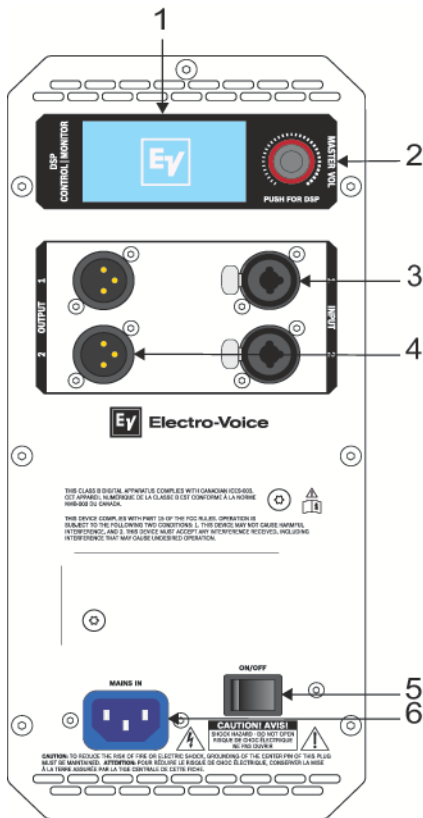

1. LCD
2. MASTER VOL/DSP
3. INPUT
4. OUTPUT
5. POWER
6. MAINS IN

For more information, see the user manual.

## Frequency response:

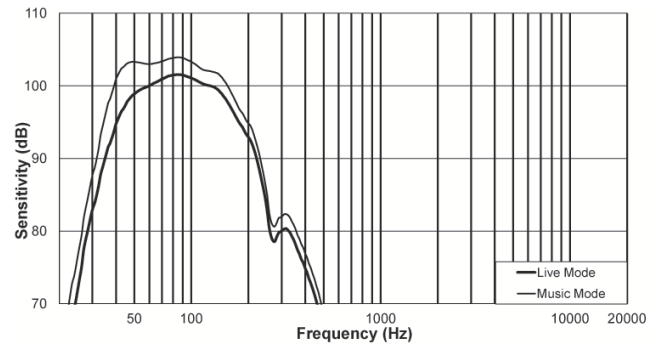

## Ordering information

### **ETX-15SP US**

15-inch powered subwoofer, black, US 120V

Order number **ETX-15SP-US**

---

### **ETX-15SP EU**

15-inch powered subwoofer, black, EU 240V

Order number **ETX-15SP-EU**

---

### **Accessories**

#### **ETX-15SP Cover**

Padded cover for ETX-15SP, EV logo

Order number **ETX-15SP-CVR**

---

#### **Represented by:**

---

##### **Germany:**

Bosch Sicherheitssysteme GmbH  
Robert-Bosch-Ring 5  
85630 Grasbrunn  
Germany

Bosch Security Systems, Inc.  
12000 Portland Avenue South  
Burnsville MN 55337  
USA

[www.electrovoice.com](http://www.electrovoice.com)