

Solid-State Memory Camcorder

Operating Guide

Identifying Parts and
Controls

Getting Started

Recording

Playback

Using Network Functions

Editing

Using the Menu

Troubleshooting

Additional Information

NXCAM

XAVC S

AVCHD
Progressive

InfoLITHIUM
V
SERIES

MEMORY STICK™

S2
XC

HDMI®
HIGH-DEFINITION MULTIMEDIA INTERFACE

NFC

Read this first

Before operating this unit, please read this manual thoroughly, and retain it for future reference.

Precautions when using the camcorder

- Do not hold the camcorder by the following parts, and also do not hold the camcorder by the jack covers.

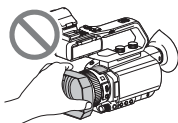

Lens hood

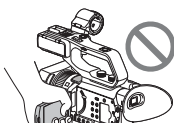

LCD screen



Microphone (sold separately) or
Microphone holder

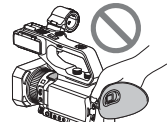

Viewfinder

Notes

- The camcorder is not dustproof, dripproof or waterproof. See "About handling of your camcorder" (p. 159).
- When connecting the camcorder to another device with communication cables, be sure to insert the connector plug in the correct way. Pushing the plug forcibly into the terminal will damage the terminal and may result in a malfunction of the camcorder.
- Use the camcorder in accordance with the regulations of the place where you use it.

On the LCD screen and lens

- A menu item that is grayed out is not available under the current recording or playback conditions.
- The LCD screen is manufactured using extremely high-precision technology, so over 99.99% of the pixels are operational for effective use. However, there may be some tiny

black points and/or bright points (white, red, blue, or green in color) that appear constantly on the LCD screen. This is not a malfunction. These points are normal results of the manufacturing process and do not affect the recording in any way.

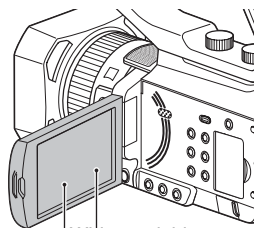

White, red, blue or green point
Black point

On sunlight

- Do not record the sun or leave the camcorder under the sun for a long time. The internal parts of the camcorder may be damaged. If sunlight is focused on a nearby object, it may cause a fire.
- Do not expose your camcorder's viewfinder, lens, or LCD screen to the sun or strong light source for extended periods. Doing so may cause a malfunction of the camcorder.
- Do not attempt to record the sun directly. Doing so may cause a malfunction of the camcorder.
- Do not expose the lens to beams, such as laser beams. That may damage the image sensor and cause the camera to malfunction.

On the temperature of your camcorder and battery pack

Your camcorder has a protective function that disables recording or playback if the temperature of your camcorder or battery pack is beyond the safely operable range. In this case, a message appears on the LCD screen or in the viewfinder (p. 144).

On recording

- In order to stabilize memory card operation, it is recommended that you format the memory card

when you use it with your camcorder for the first time. All data recorded on the memory card will be erased by formatting, and cannot be recovered. Save important data on the memory card on other media, such as a computer, before formatting the memory card.

- Before starting to record, test the recording function to make sure the picture and sound are recorded without any problems.
- Compensation for the loss of the content of recordings or the loss of recording opportunities cannot be provided, even if recording or playback is not possible due to a malfunction of the camcorder, storage media, etc., or even if images or sounds are distorted due to the limits of the capabilities of the camcorder.
- TV color systems differ depending on the countries/regions. To view your recordings on a TV, a TV of the appropriate color system for the country/region is required.
- Television programs, films, video tapes, and other materials may be copyrighted. Unauthorized recording of such materials may be contrary to the copyright laws.
- Because of the way that the image device (CMOS sensor) reads out image signals, the following phenomena may occur.
 - The subjects passing by the frame rapidly might appear crooked depending on the recording conditions. (This phenomenon may be notable in displays having high motion resolution.)
 - Horizontal lines appear on the LCD screen during recording under fluorescent lights, sodium lamps or mercury lamps. The phenomena can be reduced by adjusting the shutter speed (p. 44).

Save all your recorded image data

- To prevent your image data from being lost, save all your recorded images periodically.

To handle the recorded images on your computer

Download software (p. 19).

Format the memory card using [MEDIA FORMAT] if images are not recorded or played back properly

If you continue recording and deleting images on a memory card for a long period of time, the files on that memory card may become fragmented. As a result, you may not be able to record and save images properly. If this happens, save images on a PC, then format the memory card (p. 98).

About the operation of the camcorder

You can operate the camcorder using the ▲/▼/◀/▶/SET buttons (p. 100), and the touch panel.* However, you cannot use the touch panel to make some settings, such as the MENU items.

* Some operations are possible only with the touch panel.

About this manual

- The on-screen display in English is used for illustrating the operating procedures. Change the screen language before using your camcorder if necessary.
- The value you can set in [REC FORMAT], etc., depends on the [60i/50i SEL] setting. In this manual, the values for both [60i] and [50i] settings are described.
- Design and specifications of recording media and other accessories are subject to change without notice.

Table of Contents

Read this first	2
-----------------------	---

Identifying Parts and Controls

Identifying Parts and Controls	8
Body	8
Wireless Remote Commander	16
Screen Indicators	17

Getting Started

Step 1: Checking supplied accessories	19
Step 2: Charging the battery pack	21
Step 3: Attaching the accessory shoe	23
Step 4: Turning on the camcorder and setting the date and time	24
Turning on the camcorder	24
Setting the date and time	24
Step 5: Adjusting the LCD screen and viewfinder	26
Using the LCD screen	26
Adjusting the viewfinder diopter	26
Step 6: Preparing the recording media	27
Supported memory cards	27
Inserting a memory card	29

Recording

Recording	30
Recording	30
Continuous recording on the memory cards (Relay Rec)	31
Recording movies using both memory card A and B (Simul Rec)	32
Changing the START/STOP button/handle record button setting	32
Adjusting the zoom	33
Adjusting the focus	35
Adjusting the focus manually	35
Adjusting the focus automatically	35
Adjusting the focus while tracking a selected subject (Lock-on AF)	38
Focusing using the focus magnifier	38
Focusing by touching the LCD screen (Spot Focus)	39
Focusing on a detected face (Face Detection)	39
Selecting the file format and recording format	41
Setting the file format and recording format	41
Setting the output destination when recording in 4K mode	41

Proxy recording	42
Notes on proxy recording	42
Proxy recording	42
Adjusting the brightness	43
Adjusting the iris	43
Adjusting the ISO sensitivity/gain	44
Adjusting the shutter speed	44
Adjusting the exposure	45
Adjusting the light level (ND Filter)	45
Adjusting the color tone	46
Adjusting the white balance	46
Using Direct Menu	48
Audio setup	50
Recording sound from the internal microphone	50
Recording sound from an external audio device	50
Recording sound from a Multi Interface Shoe compatible microphone (sold separately)	51
Recording sound from an external microphone (sold separately)	52
Adjusting the audio level from the INPUT1 and INPUT2 jacks	52
Adjusting the audio level from the internal microphone or an external microphone (sold separately)	52
Useful functions	53
Selecting suitable settings automatically (auto mode setting)	53
Shooting in dimly lit locations (LOW LUX)	54
Shooting in dark conditions (NIGHTSHOT)	54
Customizing the picture quality (Picture Profile)	54
Shooting in high dynamic range (HDR)	56
Setting time data	58
Recording with the Slow & Quick Motion function	59
Slow-motion recording at high frame rate (HFR)	60
Recording with the Super Slow Motion function	60
Reviewing the most recently recorded scene (Last Scene Review)	62
Assigning functions to the ASSIGN buttons	64

Playback

Playback	65
Playback	65
Changing/checking the settings in your camcorder	67
Changing the screen display	67
Displaying recording data (Data Code)	67
Checking the settings in your camcorder (Status Check)	68
Connecting to a monitor or a TV	69
Output signal formats	70

Using Network Functions

Using with a Smartphone	74
Downloading "Content Browser Mobile"	74
Using a smartphone as a remote controller	74
Connecting the camcorder to an Android smartphone equipped with the NFC function using One-touch	75
Connecting without using the NFC function (Android)	76
Connecting without using the NFC function (iPhone/iPad)	76
Configuring a wireless LAN	77
Selecting and registering an access point	77
Registering an access point using the WPS function	78
Registering an access point using the WPS PIN method	79
Registering an access point manually	80
Changing the device name	81
Configuring a wired LAN	82
Using the streaming function (STREAMING)	83
Streaming formats	83
Configuring streaming (preset registration)	83
Streaming distribution	83
Streaming movies using RTMP/RTMPS	86
Configuring RTMP/RTMPS streaming (preset registration)	86
RTMP/RTMPS streaming distribution	86
Stopping RTMP/RTMPS	88
Importing an RTMPS certificate	88
Streaming movies using USTREAM	89
Configuring USTREAM authentication	89
Configuring using the menu	90
Starting USTREAM	90
Stopping USTREAM	91
Synchronizing the timecode of multiple cameras using a smartphone	92
To use Wireless TC LINK	92
Preparation on the smartphone	92
Synchronizing the timecode to another device using a smartphone	92
Importing a root certificate	94
Resetting network settings	95

Editing

Protecting movies (Protect)	96
Dividing a movie	96
Deleting movies	97

Formatting a memory card	98
Deleting all data from the memory card completely	98
Repairing the image database file	99

Using the Menu

Operating the menu	100
Menu items	101
CAMERA SET menu	103
REC/OUT SET menu	111
AUDIO SET menu	116
DISPLAY SET menu	118
TC/UB SET menu	122
NETWORK SET menu	123
OTHERS menu	125
EDIT menu	127
PICTURE PROFILE menu	127

Troubleshooting

Troubleshooting	136
Warning indicators and messages	144

Additional Information

Recording time	149
Function limitations when recording	151
Limitations for each file format	151
Slow & Quick Motion and Super Slow Motion recording limitations	152
Streaming, RTMP/RTMPS, and USTREAM supported formats	153
Proxy recording supported formats	154
Using your camcorder abroad	155
File/folder structure on the recording media	156
Maintenance and precautions	157
About the XAVC S format	157
About the AVCHD format	157
About memory cards	157
About the "InfoLITHIUM" battery pack	158
About handling of your camcorder	159
Specifications	163
Index	166

Identifying Parts and Controls

Body

The numbers in () are reference pages.

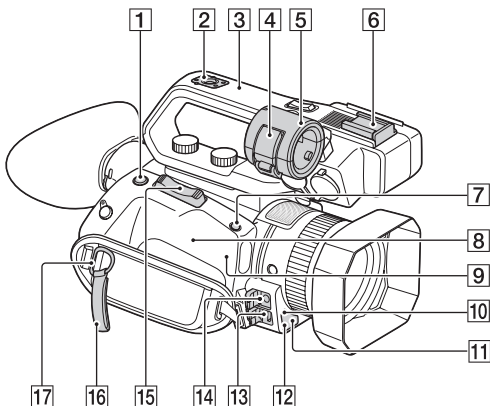

- | | |
|---|--|
| <p>1 ASSIGN4/FOCUS MAGNIFIER button (p. 38)</p> <p>2 Accessory shoe mount (p. 23)</p> <p>3 XLR handle unit</p> <p>4 Microphone fixing clamper</p> <p>5 Microphone holder</p> <p>6 Accessory shoe</p> <p>7 ASSIGN5/IRIS PUSH AUTO button (p. 43)</p> <p>8  (N mark)</p> <ul style="list-style-type: none"> • Touch an NFC-enabled smartphone to the mark to establish a connection with the camcorder. • Near Field Communication (NFC) is an international standard for short-range wireless communication technology. <p>9 WLAN antenna (built-in)
Covering this part with your hand or other object may block Wi-Fi communication.</p> <p>10 Remote control sensor (p. 126)</p> | <p>11 Recording lamp (p. 126)
Flashes when remaining capacity of the memory card or battery becomes low.</p> <p>12 NightShot light (p. 54)</p> <p>13 Multi/Micro USB jack (p. 69)
VIDEO OUT jack (p. 69, 113)</p> <p>14 MIC jack (PLUG IN POWER)</p> <p>15 Power zoom lever</p> <p>16 Cable clamper</p> <p>17 Hook for shoulder strap</p> <p>18 Multi Interface Shoe (p. 51)</p> |
|---|--|

Attaching the XLR handle unit

- ① Remove the Multi Interface Shoe cap.

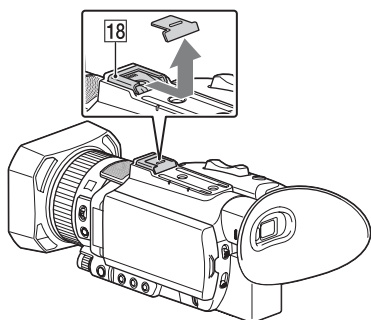

- ② Remove the handle shoe cap.

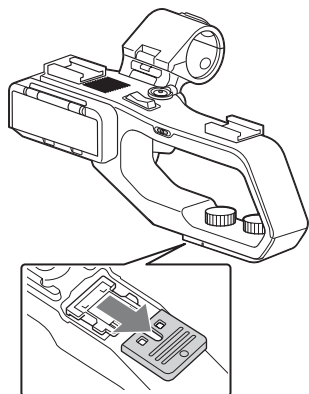

- ③ Align the mark on the XLR handle with the one on the camcorder, and insert the XLR handle unit in the direction of the arrow.

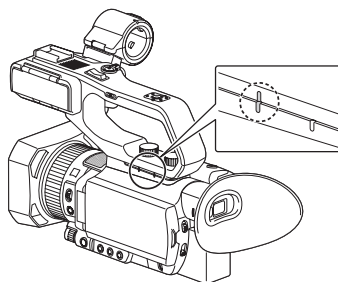
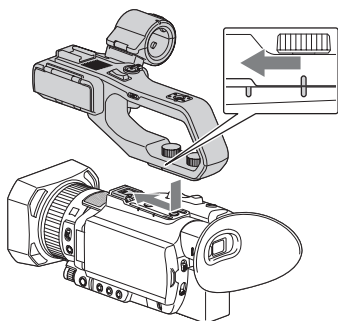

- ④ Press and turn the handle mounting screws to tighten them.

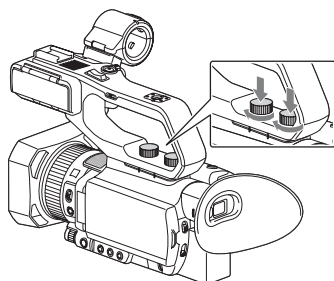

💡 Tips

- When attaching the XLR handle unit, make sure to securely tighten both handle mounting screws.
- If you use the XLR handle unit without securely tightening the mounting screws, it may damage

Identifying Parts and Controls (Continued)

the Multi Interface Shoe or cause the camcorder to detach and fall.

Detaching the XLR handle unit

To detach the XLR handle unit, perform the attachment procedure in reverse.

Attaching the microphone (sold separately)

Use the following procedure to attach an external microphone (sold separately) to record audio.

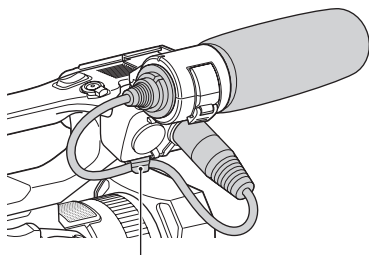

Put the cable in the outer cable holder.

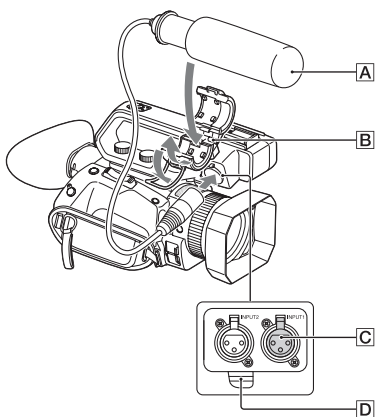

- ① Place the microphone **A** into the microphone holder **B**.
- ② Connect the plug of the microphone to the INPUT 1 jack **C**.
- ③ Place the microphone cable into the cable holder **D**.

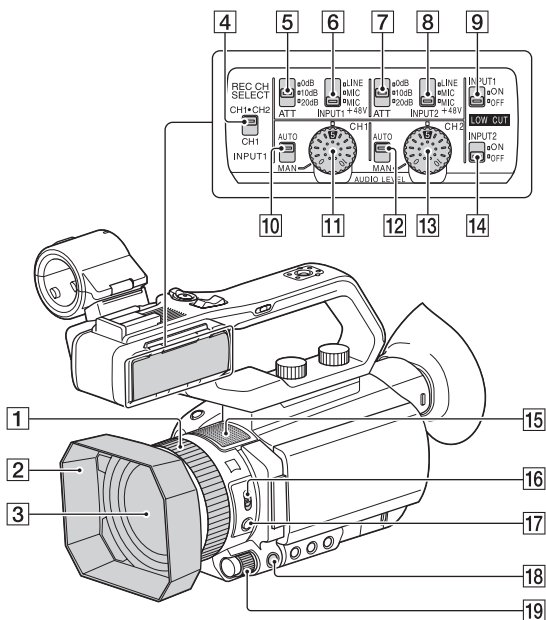

- | | |
|---|---|
| 1 Manual lens ring (p. 34) | 14 LOW CUT (INPUT2) switch (p. 51) |
| 2 Lens hood | 15 Internal microphone |
| 3 Lens (ZEISS lens) | 16 ZOOM/FOCUS switch (p. 35) |
| 4 REC CH SELECT (INPUT1) switch (p. 50) | 17 AF/MF button (p. 35) |
| 5 ATT (INPUT1) switch (p. 50) | 18 MENU button (p. 100) |
| 6 INPUT1 (LINE/MIC/MIC+48V) switch (p. 50) | 19 MANUAL dial (p. 43) |
| 7 ATT (INPUT2) switch (p. 50) | |
| 8 INPUT2 (LINE/MIC/MIC+48V) switch (p. 50) | |
| 9 LOW CUT (INPUT1) switch (p. 51) | |
| 10 AUTO/MAN (CH1) switch (p. 50) | |
| 11 AUDIO LEVEL (CH1) dial (p. 50) | |
| 12 AUTO/MAN (CH2) switch (p. 50) | |
| 13 AUDIO LEVEL (CH2) dial (p. 51) | |

Attaching the lens hood

Align the mark on the lens hood to the mark on the camcorder, and turn the lens hood in the direction of the arrow ② until it is locked.

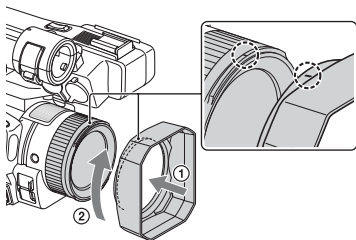

Tip

- If you attach or remove a 62 mm PL filter or MC protector, remove the lens hood.

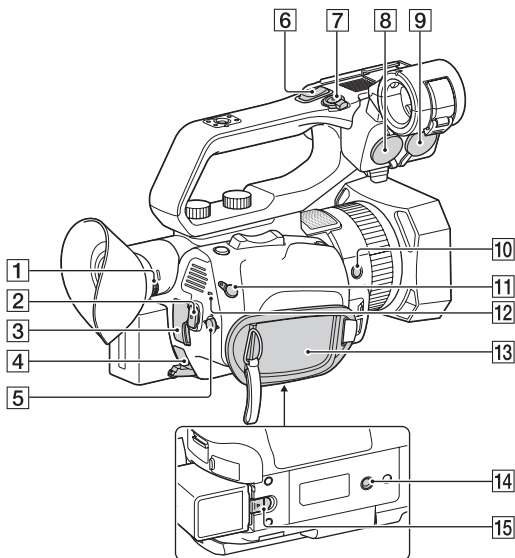



- 1** Diopter adjustment dial (p. 26)
- 2** START/STOP button (p. 30)
- 3** HDMI OUT jack (p. 69)
- 4** DC IN jack (p. 21)
- 5** ▲/▼/◀/▶/SET buttons (p. 100)
- 6** Handle zoom lever (p. 33)
- 7** Handle record button (p. 30)
- 8** INPUT2 jack (p. 50)
- 9** INPUT1 jack (p. 50)
- 10** ASSIGN6 button
- 11** REMOTE jack
- 12** POWER/CHG lamp
- 13** Grip belt
- 14** Tripod receptacles (1/4 inch)
Supports 1/4-20UNC screws.
For mounting on a tripod (sold
separately, screw length 5.5 mm or
shorter).

The camcorder may not be able to mount in some orientations, depending on the tripod specifications.

- 15** BATT release lever (p. 21)

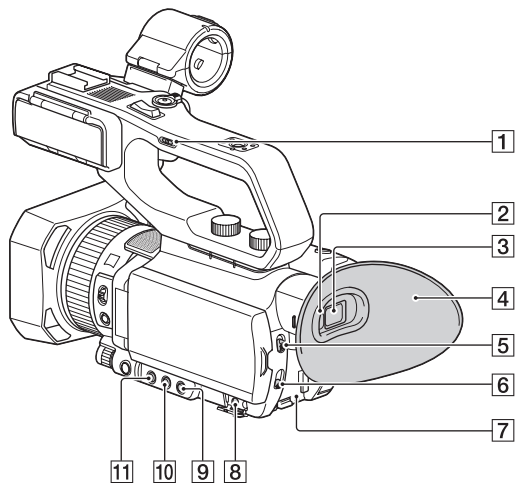
Identifying Parts and Controls (Continued)



- 1** Handle zoom speed switch (p. 33)
- 2** Eye sensor
- 3** Viewfinder (p. 26)
- 4** Large eyecup (p. 26)
- 5** AUTO/MANUAL switch (p. 43)
- 6** ND FILTER switch (p. 45)
- 7** Battery slot (p. 21)
- 8**  (headphones) jack
- 9** SHUTTER SPEED button (p. 44)
- 10** ISO/GAIN (ISO sensitivity/gain) button (p. 44)
- 11** IRIS button (p. 43)

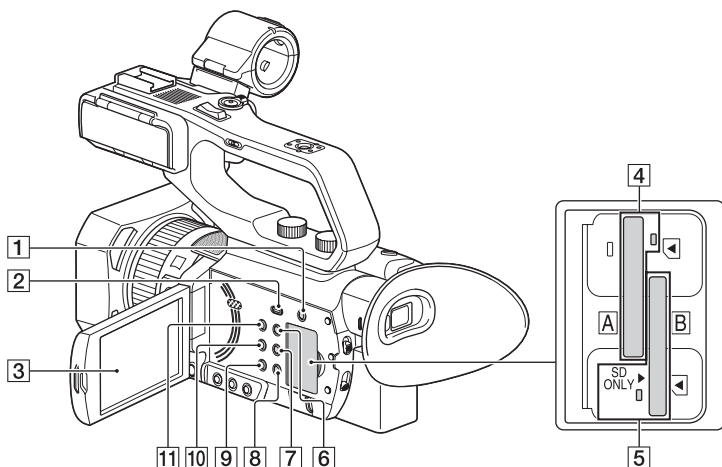

- 1** SLOT SELECT button (p. 29)
- 2** THUMBNAIL/▶ button (p. 65)
- 3** LCD screen/touch panel (p. 26)
- 4** Memory card slot A/Memory card access lamp (p. 29)
- 5** Memory card slot B/Memory card access lamp (p. 29)
- 6** DISPLAY button (p. 67)
- 7** ASSIGN3/PICTURE PROFILE button (p. 54)
- 8** ASSIGN2/STATUS CHECK button (p. 68)
- 9** ASSIGN1/S&Q button (p. 59)
- 10** WHITE BALANCE button (p. 46)
- 11** ⏻ (On/Standby) button (p. 24)

Wireless Remote Commander

Remove the insulation sheet before using the Wireless Remote Commander.

Insulation sheet

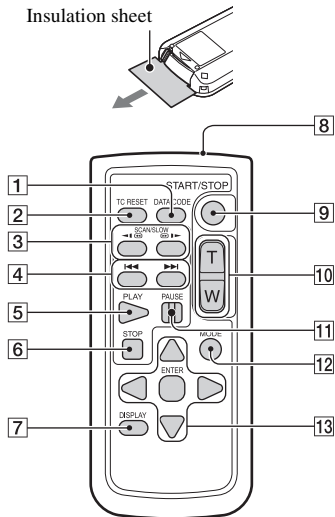

- 1 DATA CODE button (p. 67)
- 2 TC RESET button (p. 59)
- 3 SCAN/SLOW buttons (p. 65)
- 4 ◀◀ ▶▶ (PREV/NEXT) buttons (p. 65)
- 5 PLAY button (p. 65)
- 6 STOP button (p. 65)
- 7 DISPLAY button (p. 67)
- 8 Transmitter
- 9 START/STOP button (p. 30)
- 10 Power zoom lever
- 11 PAUSE button (p. 65)
- 12 MODE button
- 13 ◀/▶/▲/▼/ENTER buttons

Notes

- Aim the Wireless Remote Commander towards the remote sensor to operate your camcorder.
- Point the remote sensor away from strong light sources such as direct sunlight or overhead lighting. Otherwise, the Wireless Remote Commander may not function properly.
- When you are operating with the Wireless Remote Commander supplied with your camcorder, your video device may also operate. In that case, select a commander mode other than DVD2 for your video device, or cover the sensor of your video device with black paper.

To change the battery of the Wireless Remote Commander

- ① While pressing on the tab, inset your fingernail into the slit to pull out the battery case.
- ② Place a new battery with the + side facing up.
- ③ Insert the battery case until it clicks into place.

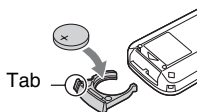

WARNING

Battery may explode if mistreated. Do not recharge, disassemble or dispose of in fire.

- When the lithium battery becomes weak, the operating distance of the Wireless Remote Commander may shorten, or the Wireless Remote Commander may not function properly. In this case, replace the battery with a Sony CR2025 lithium battery. Use of another battery may present a risk of fire or explosion.

Screen Indicators

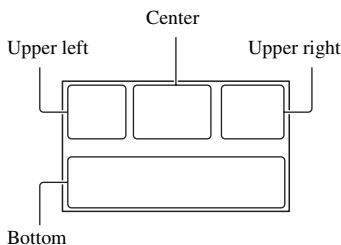

Upper left

Indicator	Meaning
100%	Remaining battery
	INTELLIGENT AUTO (face/scene detection/camera-shake detection) (p. 53)
	SCENE SELECTION (p. 53)
XAVCS 2160/30p 60 XAVCS 1080/60p 50 AVCHD 1080/60i FX	Recording format (p. 41)
	Optical zoom (p. 104)
Z99 ×1.2	Clear image zoom (p. 104)
Z99 ×2.3	Digital zoom (p. 104)
	Simultaneous recording (p. 32)
	Relay recording (p. 31)
	Proxy recording [ON] (p. 42)

Center

Indicator	Meaning
	Recording media (p. 27)
REC STBY	Recording standby (p. 30)
	Warning (p. 144)
	Playback indicator (p. 65)
	Processing

Indicator	Meaning
	Relay recording (p. 31)
	HDMI REC CONTROL (p. 115)
	Streaming (p. 83, 90)













Upper right

Indicator	Meaning
Omin	Estimated remaining recording time
	Recording/playback media
00:00:00:00	Timecode (hour:minute:second:frame) (p. 58)
	LAN connection (p. 84, 90, 93)
	Wi-Fi connection status indicator (p. 92)
	2.4GHz
	USTREAM audience (p. 90)

Bottom

Indicator	Meaning
	Face detection [ON] (p. 39)
PEAKING	Peaking (p. 118)
	Zebra (p. 118)
	NFC active (p. 75)
	Airplane mode [ON] (p. 124)
	Image stabilization (STEADYSHOT) (p. 104)
	Manual focus (p. 35)
PP1 to PP10	Picture profile (p. 54)
F5.6	Iris (p. 43)

Screen Indicators (Continued)

Indicator	Meaning
ISO800	ISO sensitivity (p. 44)
9dB	Gain (p. 44)
100 180°	Shutter speed (p. 44)
	AVCHD audio format (p. 116)
-2.0EV	AE shift (p. 104)
	Auto setting/manual setting (p. 43)
 A B 6500K	White balance (p. 46)
	Histogram (p. 118)
	LOW LUX (p. 54)
CH1  CH2 	Audio level display (p. 120)
	Digital extender (p. 104)
	REC LEVEL MODE (p. 116)
	NIGHTSHOT (p. 54)
	SELECTED MIC (p. 117)
NDOFF ND1 ND2 ND3	ND filter (p. 45)
	Gamma display assist (p. 57)

Tip

- Indicators may look different or appear at different positions.

Data during recording

The date, time, and recording conditions are recorded automatically.

They are not displayed while recording. However, you can check them by selecting  (DISPLAY SET) → [DATA CODE] and choosing the data that you want to display, or by pressing the ASSIGN button to which the DATA CODE function is assigned, during playback.

Step 1: Checking supplied accessories

Make sure that you have following items supplied with your camcorder. If, for any reason, there is something missing, contact your Sony dealer.

The number in the parentheses indicates the number of that item supplied.

AC Adaptor (p. 21)

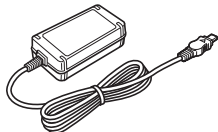

Power cord (mains lead) (p. 21)



RMT-845 Wireless Remote Commander (p. 16)



A button-type lithium battery is already installed.

Large eyecup (p. 26)



Lens hood (p. 12)

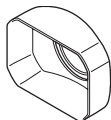

Lens cap (Attached to lens)

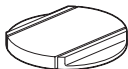

Accessory shoe kit (Accessory shoe (1), Accessory shoe plate (1), screws (4)) (p. 23)

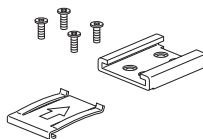

XLR handle unit

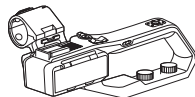

USB cable

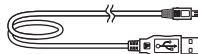

Rechargeable battery pack (NP-FV70A)

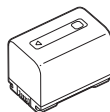

CD-ROM "Manuals for Solid-State Memory Camcorder"

Operating Guide (2)

Software Downloads

When the unit is used with a PC connection, download any device drivers, plug-ins, and application software you require from the following websites. You can work with recorded video on a computer, for example, combining relay-recorded movies, using the "Catalyst Browse" application software. For details, see the supplied brochure.

For details about NLE (Non-Linear Editing) use, contact the software maker.

Step 1: Checking supplied accessories (Continued)

Sony Professional products website:

U.S.A. <http://pro.sony.com>

Canada <http://www.sonybiz.ca>

Latin America

<http://sonypro-latin.com>

Europe, Middle East, and Africa

<http://www.pro.sony.eu>

Japan <http://www.sonybsc.com>

Asia Pacific

<http://pro.sony-asia.com>

Korea <http://bp.sony.co.kr>

China <http://pro.sony.com.cn>

Although the data regarding recorded materials are stored over multiple files and folders, you can easily handle the clips without considering its data and directory structure, by using the dedicated application software.

About paid upgrade license

- To use the Wireless TC LINK function, “CBKZ-WTCL” (sold separately) is required.
- After purchasing the option, connect the camcorder to a computer using USB to use the auto detect function, and install by following the instructions on the PC.

Step 2: Charging the battery pack

You can charge the “InfoLITHIUM” battery pack (V series) with the supplied AC Adaptor.

Note

- You can use an NP-FV100A large capacity battery pack (sold separately) with your camcorder. You cannot use an NP-FV50A.

- 1 Close the LCD screen and store the viewfinder before attaching the battery.

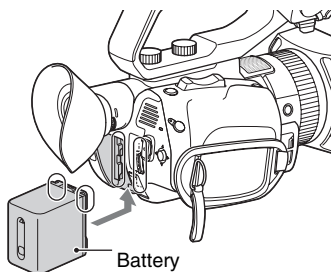

- 2 Connect the AC Adaptor and power cord from the camcorder to an outlet.

The CHG lamp lights up and charging starts.

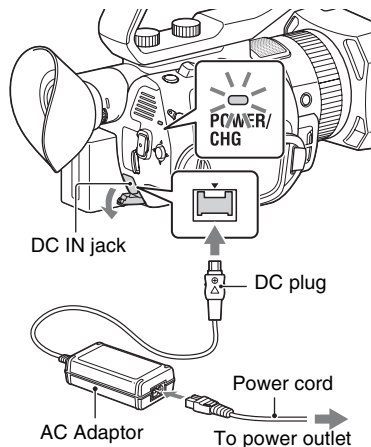

When charging ends

The CHG lamp turns off when the battery is fully charged.

Disconnect the AC Adaptor from the DC IN jack.

Tip

- You can check the remaining battery life with the status check function (p. 68).

To remove the battery pack

Turn the power off, then slide the BATT release lever to release the battery.

Step 2: Charging the battery pack (Continued)

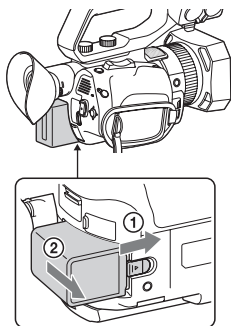

On the AC Adaptor

- Do not short-circuit the DC plug of the AC Adaptor or battery terminal with any metallic objects. This may cause a malfunction.

To store the battery pack

If the battery pack is not in use for a while, run down the battery and store it (p. 159).

Charging time

Approximate time (minutes) required when you charge a fully discharged battery pack.

Battery pack	Full charge time
NP-FV70A	170

On the battery pack

- Turn the power off before changing the battery pack.
- The CHG lamp flashes during charging, or the Battery Info will not be correctly displayed under the following conditions.
 - The battery pack is not attached correctly.
 - The battery pack is damaged.
 - The battery pack is worn-out.

Using a power outlet

You can use the AC Adaptor to obtain the AC power. While you are using the AC Adaptor, the battery pack will not lose its charge even when it is attached to your camcorder.

Perform the procedure up to step 2 of “Step 2: Charging the battery pack” (p. 21).

Step 3: Attaching the accessory shoe

To mount the accessory shoe

Mount the accessory shoe on the accessory shoe mount as illustrated.

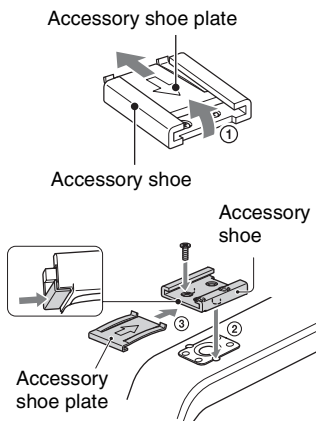

- ① Lift the edge of the accessory shoe plate and pull it in the direction opposite to that of the arrow on the accessory shoe plate and remove it from the accessory shoe.
- ② Place the accessory shoe as its protrusions matches recesses of the accessory shoe mount, then fix it to the mount with 4 screws.
- ③ Insert the accessory shoe plate in the direction of the arrow on the plate surface until the end of the plate engages the end of the shoe.

To remove the accessory shoe

Remove the shoe plate in the same way as step ① of “To mount the accessory shoe.” Loosen the 4 screws and remove the accessory shoe from the accessory shoe mount.

Step 4: Turning on the camcorder and setting the date and time

Turning on the camcorder

Open the LCD screen and turn the power on.

You can also turn on the power by extending the viewfinder or by pressing the  (On/Standby) button.

When you use your camcorder for the first time, the [CLOCK SET] screen appears.

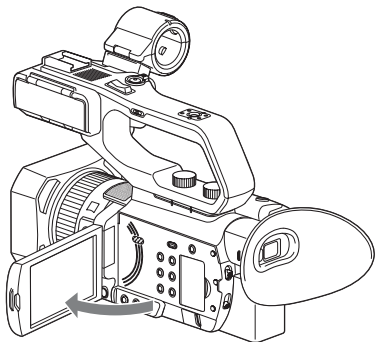

To turn off the power

Close the LCD screen.

If the viewfinder is extended, return it to its original position.

You can also turn off the power by pressing the  (On/Standby) button.

Notes

- If a warning message is displayed, follow the instructions.
- When recording movies or when connected to another device via USB, the camcorder does not turn off even if the LCD screen is closed and the viewfinder is returned to its original position.

Setting the date and time

Set the date and time when you use your camcorder for the first time.

Tip

- If you do not use your camcorder for about **3 months**, the built-in rechargeable battery gets discharged and the date and time settings may be cleared from the memory. In that case, charge the rechargeable battery and then set the date and time again (p. 161).

LCD screen

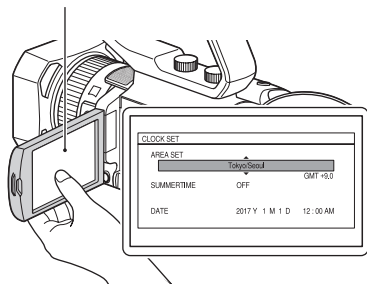

To set the date and time again, press the MENU button, and select  (OTHERS) → [CLOCK SET].

1 Set the area.

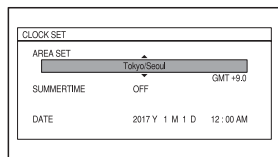

2 Set [SUMMERTIME], [Y], [M], [D], hour, and minute.

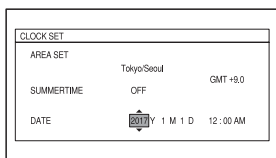

The clock starts.

- Set [SUMMERTIME] to [ON] to move the time forward 1 hour.
- You can set any year up to the year 2037.
- Midnight is indicated as 12:00 AM, and noon as 12:00 PM.

 **Tip**

- The date and time are automatically recorded on the selected memory card, and can be displayed during playback (p. 67).

Step 5: Adjusting the LCD screen and viewfinder

Using the LCD screen

The LCD screen can be rotated in the range as illustrated below, allowing a person other than the camera operator to see the image.

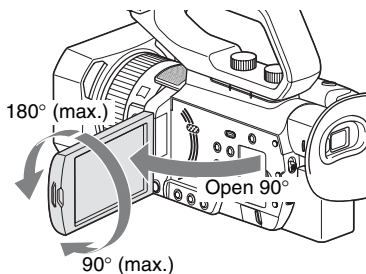

Adjusting the viewfinder diopter

When using the viewfinder, extend it and position your eye near it. If you extend the viewfinder while the LCD screen is open, the display switches from the LCD screen to the viewfinder when you position your eye near the viewfinder. If the viewfinder image appears blurred, turn the diopter adjustment dial next to the viewfinder until the image is sharp.

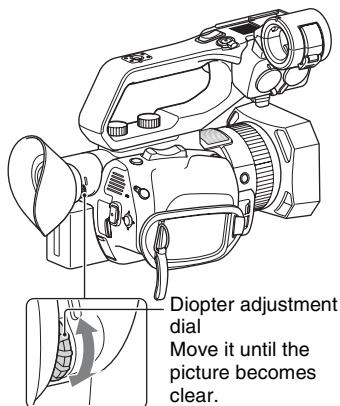

Note

The LCD screen and the viewfinder do not operate at the same time.

When the picture in the viewfinder is hard to see

If you cannot see the picture in the viewfinder clearly under bright circumstances, use the supplied large eyecup. To attach the large eyecup, stretch it slightly and fit it over the groove of the eyecup attached to the camcorder. You can attach the large eyecup facing either the right or left side.

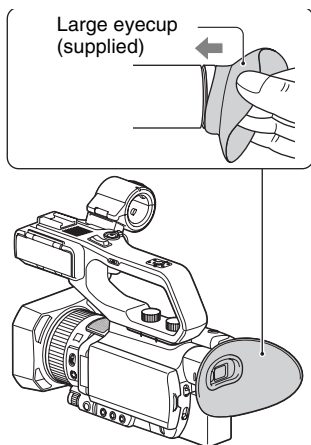

Note

- If the viewfinder is extended while the NP-FV100A battery pack (sold separately) is attached, the large eyecup and battery pack may interfere with each other slightly. However, this does not affect the functionality of the camcorder.

Step 6: Preparing the recording media

Supported memory cards

Refer to the following lists when selecting memory cards to use.

In this document, SD cards or “Memory Stick” media are referred to as supported memory cards.

SD card

File format	Supported memory cards
AVCHD	SD/SDHC/SDXC memory cards (Class 4 or U1 or faster)
	S&Q MOTION SDHC/SDXC memory cards (Class 10 or U1 or faster)
	SUPER SLOW MOTION SDHC/SDXC memory cards (Class 10 or U1 or faster)
XAVC S HD	60Mbps or slower SDHC/SDXC memory cards (Class 10 or U1 or faster)
	100Mbps SDHC/SDXC memory cards (U3)
	S&Q MOTION SDHC/SDXC memory cards (Class 10 or U1 or faster)
XAVC S 4K	SUPER SLOW MOTION SDHC/SDXC memory cards (Class 10 or U1 or faster)
	60Mbps or slower SDHC/SDXC memory cards (Class 10 or U1 or faster)
	100Mbps SDHC/SDXC memory cards (U3)
	S&Q MOTION SDHC/SDXC memory cards (U3)
	SUPER SLOW MOTION —

“Memory Stick” media

File format	Supported memory cards
AVCHD	Memory Stick PRO Duo (Mark2), Memory Stick PRO-HG Duo
	S&Q MOTION SUPER SLOW MOTION —
XAVC S HD, XAVC S 4K	S&Q MOTION SUPER SLOW MOTION —

Notes

- Operation with all memory cards is not assured. For details about non-Sony memory cards, contact each manufacturer.
- See page 149 for the recording time of memory cards.
- Only “Memory Stick PRO Duo” media, which is half the size of standard “Memory Stick” media, or “Memory Stick XC-HG Duo” media, or standard size SD cards can be used with this camcorder.
- Movies recorded on “Memory Stick XC-HG Duo” media or SDXC memory cards can be imported to or played back on other equipment, such as a computer or A/V device, by connecting the camcorder to the equipment with the USB cable. However, the equipment must support the exFAT file system used for

Step 6: Preparing the recording media (Continued)

“Memory Stick XC-HG Duo” media and SDXC memory cards. Confirm in advance that the connecting equipment is supporting the exFAT file system. If you connect equipment not supporting the exFAT file system and the format screen appears, do not perform the format. All the data recorded will be lost.

Inserting a memory card

Open the cover, and insert the memory card with the notched corner in the direction as illustrated until it clicks into place.

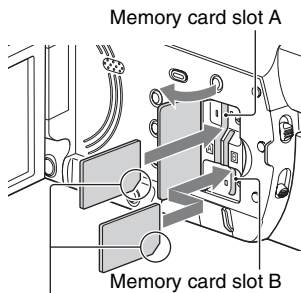

Note the direction of the notched corner.

- If you insert a memory card into the slot in the wrong direction, the memory card, the memory card slot, or image data may be damaged.
- Memory card slot A accepts both “Memory Stick PRO Duo” and SD cards. Memory card slot B accepts SD cards only.

To eject a memory card

Lightly push the memory card once.

Notes

- If “The image database file is corrupted. The media must be restored to use again.” appears, format the memory card (p. 98).
- When inserting or ejecting a memory card, be careful of the memory card popping out and dropping.

Selecting the memory card slot to be used for recording

Press the SLOT SELECT button to change which slot is selected for recording. You can confirm the selected slot on the screen.

SLOT SELECT button

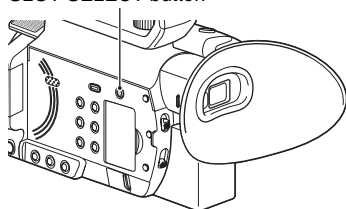

Notes

- You can only select a slot that already has a memory card inserted.
- When recording to a memory card, you cannot switch the slot even if you press the SLOT SELECT button.

Tips

- When only one slot has a memory card inserted, the slot that has the memory card is selected automatically.
- When the memory card becomes full during recording, the camcorder automatically switches to the other slot if a memory card is inserted (relay recording, p. 31).

If a repair memory card prompt screen appears

There may have been a problem recording to the memory card during the most-recent recording. Select [OK] to repair the card to the extent possible. Select [CANCEL] to continue without repairing.

Notes

- Correct repair may not be possible, even when repair is executed.
- Repair is not supported if an error occurs when recording in XAVC S format.

Recording

Your camcorder records movies on memory cards. The factory setting for recording is XAVC S 4K.

Check that the memory cards are inserted correctly, and press the START/STOP button (handle record button) to start recording.

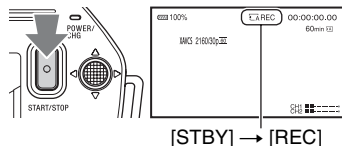

The recording lamps light up during recording.

To stop recording, press the START/STOP button (handle record button) again.

Notes

- When [AUTO] is selected in the [MIC SELECT] menu and the XLR handle unit is connected to the camcorder without a microphone attached to the INPUT1 and INPUT2 jacks, the internal microphone is not selected and no audio is recorded. In this case, select [INT MIC] (p. 50).
- If the file format is XAVC S 4K and [4K REC OUTPUT] is switched to [EXTERNAL OUTPUT], then [NIGHTSHOT LIGHT] is set to [OFF].
- If recording in XAVC S 4K is started with [4K REC OUTPUT] set to [EXTERNAL OUTPUT], then [LCD BRIGHT] is set to [NORMAL].
- If the file format is AVCHD or XAVC S HD and [SIMUL/RELAY REC] is switched to [SIMULTANEOUS REC], then [NIGHTSHOT LIGHT] is set to [OFF].
- If the file format is XAVC S 4K and streaming is started, then [4K REC OUTPUT] is set to [VF/LCD PANEL], [NIGHTSHOT LIGHT] is set to [OFF], and [LCD BRIGHT] is set to [NORMAL] while streaming.
- If the file format is AVCHD or XAVC S HD and streaming is started, then [NIGHTSHOT LIGHT] is set to [OFF] and [LCD BRIGHT] is set to [NORMAL] while streaming.
- When the access lamp is lit or flashing in red, your camcorder is reading or writing data. Do not shake or apply strong force to your camcorder, do not turn the power off, and do not remove the memory card, battery pack or the AC Adaptor. The image data may be destroyed.
- If a movie file size exceeds 2 GB while recording in AVCHD format, the camcorder automatically divides the file and creates a new one.
- The menu settings, picture profile settings, and settings made using the AUTO/MANUAL switch are saved when you close the LCD screen and turn off the camcorder. The POWER/CHG lamp flashes while the settings are being stored. If you remove the battery or disconnect the AC Adaptor with the power turned on without closing the LCD screen, interrupting the power, the settings will not be saved.

Tips

- The picture aspect ratio is fixed to 16:9.
- For details about changing the screen display during recording, see page 67.
- For details about screen display during recording, see page 17.
- The recording lamps can be set to stay off ([REC LAMP], p. 126).
- See page 149 about the recording time of movies.

Continuous recording on the memory cards (Relay Rec)

Insert memory cards each in both slots A and B so the camcorder switches memory card A (or B) just before the remaining space on the other one runs out, and continues recording on the next memory card automatically.

Make the following setting before recording.

Set \Rightarrow (REC/OUT SET) \rightarrow [REC SET] \rightarrow [SIMUL/RELAY REC] \rightarrow [RELAY REC].

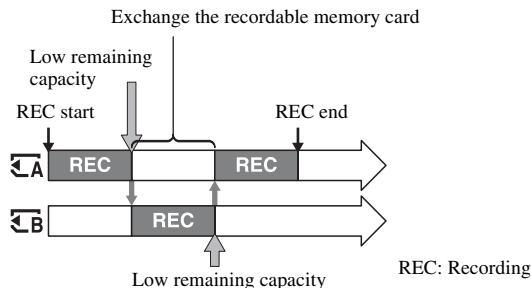

Notes

- Do not eject the memory card that is currently being used for recording. When replacing a memory card while recording, replace only the one in the slot whose access lamp is off.
- Even if you press the SLOT SELECT button, while recording movies, you cannot switch the slot currently being used.
- When the remaining recording time of the memory card being used is less than 1 minute and the other slot has a recordable memory card inserted, [$\overline{\text{A}}$ \rightarrow $\overline{\text{B}}$] or [$\overline{\text{B}}$ \rightarrow $\overline{\text{A}}$] appears on the camcorder screen. The indicator turns off when the memory card is switched.
- If you start recording on a memory card with the remaining recording time of less than 1 minute, the camcorder may not be able to relay-record. To relay-record without failing, make sure that the memory card has more than 1 minute when you start recording.
- Seamless playback of relay-recorded movies with this camcorder is not possible.
- You can combine relay-recorded movies using application software (p. 19).
- The maximum continuous recording time is 13 hours for XAVC S (HD/4K), and AVCHD. Recording stops automatically when the maximum recording time elapses.

Recording movies using both memory card A and B (Simul Rec)

You can record movies on both memory card A and memory card B simultaneously. Set \Rightarrow (REC/OUT SET) \rightarrow [REC SET] \rightarrow [SIMUL/RELAY REC] \rightarrow [SIMULTANEOUS REC].

🔗 Notes

- If an SDHC memory card is inserted in memory card slot A/B and an SDXC memory card is simultaneously inserted in the other memory card slot, data is recorded only to the SDXC memory card when the file format is XAVC S (HD/4K), even if [SIMULTANEOUS REC] is enabled.
- If the file format is AVCHD or XAVC S HD and [SIMUL/RELAY REC] is switched to [SIMULTANEOUS REC], then [NIGHTSHOT LIGHT] is set to [OFF].

Changing the START/STOP button/handle record button setting

You can start and stop recording on different memory cards by using the START/STOP button and the handle record button.

In the default setting, movies are recorded on both the memory card A and B at the same time when either record button is pressed.

- REC BUTTON: $\overline{\text{A}}$ $\overline{\text{B}}$
- HANDLE REC BUTTON: $\overline{\text{A}}$ $\overline{\text{B}}$

To change the setting

Select \Rightarrow (REC/OUT SET) \rightarrow [REC SET] \rightarrow [REC BUTTON SETTING].

REC BUTTON SETTING setting	Button and memory card
REC BUTTON: $\overline{\text{A}}$ $\overline{\text{B}}$ HANDLE REC BUTTON: $\overline{\text{A}}$ $\overline{\text{B}}$	Recording on both the memory card A and the memory card B starts and stops at the same time when either record button is pressed.
REC BUTTON: $\overline{\text{A}}$ HANDLE REC BUTTON: $\overline{\text{B}}$	Recording on the memory card A starts and stops when the START/STOP button is pressed, and on the memory card B when the handle record button is pressed.
REC BUTTON: $\overline{\text{B}}$ HANDLE REC BUTTON: $\overline{\text{A}}$	Recording on the memory card B starts and stops when the START/STOP button is pressed, and on the memory card A when the handle record button is pressed.

🔗 Note

- If an SDHC memory card is inserted in memory card slot A/B and an SDXC memory card is simultaneously inserted in the other memory card slot, only the buttons assigned to the slot in which the SDXC memory card is inserted are enabled when the file format is XAVC S (HD/4K).

Adjusting the zoom

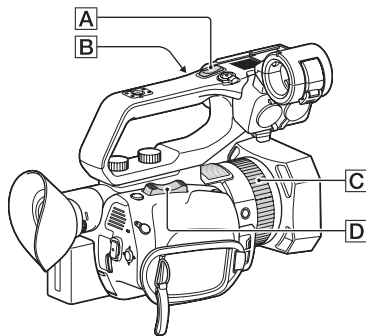

Adjusting the zoom with the power zoom lever

Press the zoom lever **D** slightly to zoom slowly, and press it further to zoom more quickly.

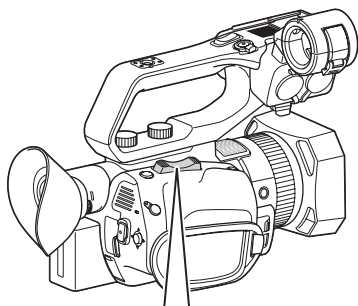

Wide angle view:
Wide



Close view:
Telephoto

⚡ Tips

- When focusing, the minimum distance required between the camcorder and the subject is about 1 cm (about 13/32 in.) for wide angle and about 1 m (about 39 3/8 in.) for telephoto.
- The focus may not be adjusted at certain zoom positions if the subject is within 1 meter (about 39 3/8 in.) from your camcorder.
- Be sure to keep your finger on the power zoom lever **D**. If you remove your finger, the operation sound of the power zoom lever **D** may also be recorded.
- You can select the type of zoom operation for the zoom lever **D** ([ZOOM TYPE], p. 104).
- You can increase the zoom speed of the power zoom lever **D** ([SPEED ZOOM], p. 104).

Adjusting the zoom with the handle zoom

- ① Set the handle zoom speed switch **B** to VAR or FIX.

⚡ Tips

- When set to VAR, you can zoom in or out at variable speed.
 - When set to FIX, you can zoom in or out at fixed speed (set in [HANDLE ZOOM], p. 104).
- ② Press the handle zoom lever **A** to zoom in or out.

⚡ Notes

- You cannot use the handle zoom when the handle zoom speed switch **B** is set to OFF.
- You cannot change the zoom speed of the power zoom lever **D** with the handle zoom speed switch **B**.

⚡ Tips

- You can select the type of zoom operation for the handle zoom lever **A** ([ZOOM TYPE], p. 104).
- You can increase the zoom speed of the handle zoom lever **A** ([SPEED ZOOM], p. 104).

Adjusting the zoom with the manual lens ring

If you toggle the ZOOM/FOCUS switch to ZOOM, you can zoom at the desired speed by turning the manual lens ring . Fine adjustment is also possible.

Note

- Turn the manual lens ring  at a moderate speed. If you turn it too fast, the zoom speed may lag behind the manual lens ring rotation speed, or the operation sound of the zoom may also be recorded.

Adjusting the focus

You can adjust the focus manually or automatically for different recording conditions.

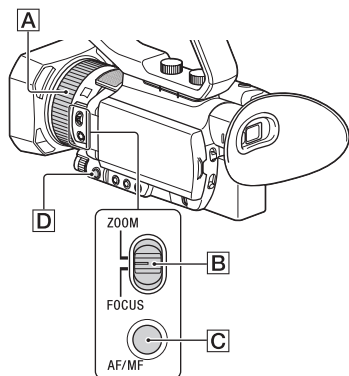

Adjusting the focus manually

1 During recording or standby, press the AF/MF button **C** to set the focus to manual.

appears.

2 Move the ZOOM/FOCUS **B** switch, and turn the manual lens ring **A**.

- FOCUS: You can manually adjust the focus by turning the manual lens ring.
- ZOOM: You can manually adjust the zoom by turning the manual lens ring. changes to when the focus cannot be adjusted any farther, and changes to when the focus cannot be adjusted any closer.

Adjusting the focus automatically

Press the AF/MF button **C** to set the focus to automatic. disappears and automatic focus adjustment is restored.

The camcorder uses phase detection AF for high-speed focusing and contrast AF for high-accuracy focusing.

The combination of these two AF methods provides auto focus with both high speed and high accuracy.

When phase detection AF is enabled, phase detection AF frames are displayed on the screen when [PHASE AF FRAMES] is set to [ON]. And the phase detection AF area is displayed on the screen when [PHASE DETECT. AF AREA] is set to [ON].

The position for focusing is indicated by white phase detection AF frames, and the frames turn green when the image is in focus.

Phase detection AF frames

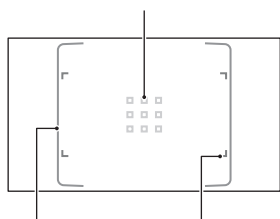

Phase detection AF area

Notes

- Phase detection AF frames are displayed only when [FOCUS AREA] is set to [WIDE] or [ZONE]. If set to [CENTER] or [FLEXIBLE SPOT] and phase detection AF is enabled, the focus area frame is displayed green to indicate the in-focus state.
- The auto focus function cannot be used when shooting in Super Slow Motion.

Tips

- The focal length information (the distance at which the subject is in focus; for when it is dark

Adjusting the focus (Continued)

and hard to adjust the focus) appears for about 3 seconds in the following cases.

- When you press the AF/MF button **[C]** to set the focus to manual and **[∞]** appears on the LCD screen.
 - When you rotate the manual lens ring **[A]** while **[∞]** is displayed on the LCD screen.
- You can switch the focal length information between meters and feet ([FOCUS DISPLAY], p. 120).

Selecting the focus area

You can change the position for focusing used by auto focus.

This is useful when the composition and movement range of the subject are determined in advance, or when focusing on an intended subject is difficult.

- ① Press the MENU button **[D]**, and select **[CAMERA SET]** → **[FOCUS AREA]**.
- ② Select **[WIDE]**, **[ZONE]**, **[CENTER]**, or **[FLEXIBLE SPOT]**.
When **[ZONE]** or **[FLEXIBLE SPOT]** is selected, touch the position for focusing on the next displayed screen.

Notes

- **[FOCUS AREA]** is fixed to **[WIDE]** in the following cases.
 - When using Clear Image Zoom
 - When using Digital Zoom
 - When auto mode shooting with **[SCENE SELECTION]** setting
 - When auto mode shooting with **[INTELLIGENT AUTO]** setting
 - When using lock-on AF
 - When the priority face is selected with face detection (**[FACE DETECTION]**)
- The focus area setting is disabled when shooting in Super Slow Motion.
- When using non-optical zoom, the focus area setting is disabled and the focus area frame is displayed using dotted lines.

To focus on a position when **[WIDE]** is selected

When **[FOCUS AREA]** is set to **[WIDE]** and an unintended position is in focus, touch the position at which you want to focus on the LCD screen to automatically focus at that position.

The area that can be touched is limited to the phase detection AF area.

About phase detection AF

When there are phase detection AF distance measurement points within the focus area, auto focus uses a combination of phase detection AF and contrast AF.

Note

- Phase detection AF cannot be used in the following cases. Only contrast AF is used.
 - When the file format is XAVC S HD and the recording format is 120p/100p
 - When **[HIGH FRAME RATE]** is enabled in **[S&Q MOTION]**
 - When using **[NIGHTSHOT]**
 - When the iris is F8.0 or larger

Selecting the AF drive speed

You can select the speed for focusing used by auto focus.

- ① Press the MENU button **[D]**, and select **[CAMERA SET]** → **[AF DRIVE SPEED]**.
- ② Select a drive speed in the range **[1[SLOW]]** to **[7[FAST]]**.

1 to 4: The focus moves slowly when the subject to be focused changes, enabling the shooting of impressive images.

5 to 7: The higher the speed, the faster the focus follows the subject. This enables continuous focus on fast-moving subjects, making it suitable for shooting active scenes, such as sports.



Notes

- The AF drive speed setting is disabled in the following cases.

- When the file format is XAVC S HD and the recording format is 120p/100p
- When [HIGH FRAME RATE] is enabled in [S&Q MOTION]
- When using [NIGHTSHOT]
- When [INTELLIGENT AUTO] is enabled
- For subjects with low contrast or subjects in dark places, AF may operate at the optimum speed regardless of the speed setting.

Setting AF subject tracking

You can select the tracking sensitivity used by auto focus.

- ① Press the MENU button , and select  (CAMERA SET) → [AF SUBJ. TRACK SET].
- ② Set [AF TRACKING DEPTH] and [AF SUBJ. SWITCH. SENS.].

AF TRACKING DEPTH:

This sets the range for tracking subjects in the depth direction in the range [1[NARROW]] to [5[WIDE]].

The wider the range, the faster the response to subjects with large motion, allowing focusing on subjects with different distances one after the other.

The narrower the range, focusing can be maintained on subjects with less movement. This is useful to maintain focus on a subject under conditions where other subjects may pass in front of the intended subject.

AF SUBJ. SWITCH. SENS.:

This sets the time taken for focusing on a new subject when switching subjects in the range [1[LOCKED ON]] to [5[RESPONSIVE]].

The shorter the time, the faster the response to changing subjects, allowing focusing on different subjects one after the other.

The longer the time, the longer the focus is maintained. This focus response delay allows you to maintain the focus on a subject if the subject is temporarily placed outside the focus area and then immediately returned to within the focus area.

Example [AF TRACKING DEPTH] / [AF SUBJ. SWITCH. SENS.] settings

Trains/motor sports

When there is nothing in the foreground and you want to follow subjects with regular movement and speed.

[AF TRACKING DEPTH]: 4
[AF SUBJ. SWITCH. SENS.]: 5

Sports/wildlife

When you want to track a specific subject with fast and irregular movement.

[AF TRACKING DEPTH]: 4
[AF SUBJ. SWITCH. SENS.]: 2

Landscape/macro shooting

When the movement of the subject is small, but there are many scene changes whose tempo you want to capture.

[AF TRACKING DEPTH]: 1
[AF SUBJ. SWITCH. SENS.]: 5

Parties/festivals

When you want to track a slow-moving subject but other subjects or people appear in the foreground.

[AF TRACKING DEPTH]: 1
[AF SUBJ. SWITCH. SENS.]: 1

Note

- The AF subject tracking settings are disabled in the following cases.
 - When the file format is XAVC S HD and the recording format is 120p/100p
 - When [HIGH FRAME RATE] is enabled in [S&Q MOTION]
 - When using [NIGHTSHOT]
 - When [INTELLIGENT AUTO] is enabled

Adjusting the focus (Continued)

Adjusting the focus while tracking a selected subject (Lock-on AF)

You can touch the screen to select a subject to track for focusing (default setting is [OFF]).

1 Press the **MENU** button .

2 Select  (**CAMERA SET**) → **[LOCK-ON AF]** → **[ON]**.

3 Touch the subject you want to track on the LCD screen.

To cancel Lock-on AF

Select .

Notes

- Lock-on AF may not provide optimum results for the following subjects and shooting conditions.
 - Subject is moving too quickly
 - Subject is too small or too large
 - Subject and background are similar colors
 - Dark scenes
 - Scenes with changing brightness
- Lock-on AF cannot be used in the following cases.
 - When the file format is XAVC S HD and the recording format is 120p/100p
 - When using Digital Zoom
 - When using focus magnification (FOCUS MAGNIFIER)
 - When shooting in HFR (High Frame Rate)
 - When shooting in Super Slow Motion
 - When the file format is XAVC S 4K and [PROXY REC MODE] is set to [ON]
 - During HDMI output when the file format is XAVC S 4K

- During streaming (STREAMING)
 - During streaming (RTMP/RTMPS)
 - During streaming (USTREAM)
 - When using Wireless TC LINK (WIRELESS TC LINK)
 - When using the digital extender (D. EXTENDER)
 - During color bar display
- If a fixed time has elapsed since a subject being tracked is lost from view, it may not be possible to resume tracking the subject.
 - [FOCUS AREA] is set to [WIDE] while using lock-on AF.

Focusing using the focus magnifier

The selected area on the LCD screen is magnified and displayed. This is useful when adjusting the focus.



[FOCUS MAGNIFIER] is assigned to the ASSIGN4/FOCUS MAGNIFIER button (p. 64).

Press the ASSIGN4/FOCUS MAGNIFIER button.

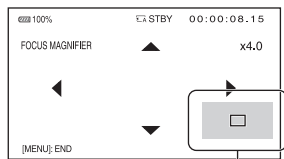
The center of the screen is magnified. The setting changes with each press of the button.



Enlarged display position

You can adjust the enlarged display position with the / buttons on the camcorder. Press the SET button to set the enlarged display position back to the center.

Note

- Even though the image appears enlarged on the LCD screen, the recorded image is not enlarged.

Tip

- You can change the magnification ratio with [FOCUS MAG RATIO] (p. 119).

Focusing by touching the LCD screen (Spot Focus)

You can focus on the point where you touch on the LCD screen.

1 Press the MENU button .

2 Select  (CAMERA SET) → [SPOT FOCUS].

3 Touch the point to be focused on the LCD screen.

Note

- [SPOT FOCUS] is available only with manual focus.

To cancel the spot focus

Press the MENU button .

Focusing on a detected face (Face Detection)

The camcorder detects faces and focuses on one of them (default setting is [ON]). [FACE DETECTION] is available only with automatic focus.

1 Press the MENU button .

2 Select  (CAMERA SET) → [FACE DETECTION] → [ON].

When a face is detected, a gray face detection frame is displayed. When auto focusing is possible, a white frame is displayed. If phase detection AF is enabled, a green frame is displayed when in focus.

To set face detection

Move the selection cursor (orange colored underline) to select the priority face, then press the /SET button.

Priority face frame (double frame)



Selection cursor (orange)

The frame on the priority face changes to a double frame.

To cancel the priority face

Move the selection cursor to the priority face frame, then press the /SET button to cancel the priority face.

Notes

- Faces may not be detected depending on the recording environment, the condition of the subject or the settings.
- You may not be able to get the proper effect in some recording environments. If this happens, set [FACE DETECTION] to [OFF].
- Face detection is disabled in the following cases.
 - When using Clear Image Zoom
 - When using Digital Zoom
 - When using NightShot

Adjusting the focus (Continued)

- For details about limitations of face detection, see “Function limitations when recording” (p. 151) and “Slow & Quick Motion and Super Slow Motion recording limitations” (p. 152).
- When [LOCK-ON AF] is set to [ON], the selection cursor is not displayed, and a priority face cannot be selected.

Tips

- Only faces within the set focus area can be focused.
- If [FOCUS AREA] is set to [WIDE], the focus area frame is not displayed when [FACE DETECTION] is set to [ON].
- To make it easy to detect faces, record under the following conditions:
 - Record in a moderately bright place.
 - Do not obscure the face with a hat, mask, sunglasses, etc.
 - Face the front of the camera.

Selecting the file format and recording format

Setting the file format and recording format

Set the file format in **↔ (REC/OUT SET)** → [REC SET] → [FILE FORMAT] and the recording format (bit rate, picture size, frame rate, scanning method) in **↔ (REC/OUT SET)** → [REC SET] → [REC FORMAT] (p. 111).

Setting the output destination when recording in 4K mode

You can select the output for the video signal when recording in XAVC S 4K.

1 Press the MENU button.

2 Select **↔ (REC/OUT SET)** → [VIDEO OUT] → [OUTPUT SELECT] → [4K REC OUTPUT].

3 Select the output destination.

VF/LCD PANEL

Output to viewfinder/LCD screen.

EXTERNAL OUTPUT

Output to an external device.

- If recording in XAVC S 4K is started with [4K REC OUTPUT] set to [EXTERNAL OUTPUT], then [LCD BRIGHT] is set to [NORMAL].
- Any one of the following functions can be used while recording in XAVC S 4K.
 - 4K REC OUTPUT
 - FACE DETECTION
 - Proxy recording

🔗 Notes

- The [4K REC OUTPUT] settings are enabled only when the file format is XAVC S 4K.
- The picture being recorded is not displayed on the viewfinder/LCD screen when [4K REC OUTPUT] is set to [EXTERNAL OUTPUT]. Also, [NIGHTSHOT LIGHT] is set to [OFF].
- The picture is output to the viewfinder/LCD screen when recording and streaming, even when set to [EXTERNAL OUTPUT].

Proxy recording

This function allows you to simultaneously record a low bitrate proxy file at the same time as recording the high bitrate original file movie.

Notes on proxy recording

Function limitations when proxy recording

Some functions on the camcorder may be unavailable when proxy recording. For details, see “Function limitations when recording” (p. 151).

Proxy recording supported formats

Proxy recording is supported when the file format is set to other than AVCHD. There are also limitations on the size of the original file movie and the proxy file movie. For details, see “Proxy recording supported formats” (p. 154).

Supported media for proxy recording

See “Supported memory cards” (p. 27).

Proxy recording

1 Press the **MENU** button.

2 Select **↔** (**REC/OUT SET**) → **[REC SET]** → **[PROXY REC MODE]** → **[ON/OFF]** → **[ON]**.
[Px] appears on the screen.

3 Select **↔** (**REC/OUT SET**) → **[REC SET]** → **[PROXY REC MODE]** → **[SIZE]** → desired picture size.

4 Press the **START/STOP** button (handle record button) to start recording.

Notes

- The camcorder can no longer record when the maximum number of XAVC S movie files is reached (600).
- The following functions are not available when proxy recording is on.
 - COLOR BAR
 - DATE REC
 - S&Q MOTION
 - SUPER SLOW MOTION

About proxy recording files

- For details about the storage location of proxy recording files, see “File/folder structure on the recording media” (p. 156).
- Proxy files cannot be played on the camcorder. **[Px]** appears on the thumbnail of the original file.
- A proxy file is also deleted/protected when the corresponding original file is deleted/protected.

Adjusting the brightness

You can adjust the image brightness by adjusting the iris, ISO sensitivity/gain or shutter speed, or by adjusting the light level with the ND filter **E**.

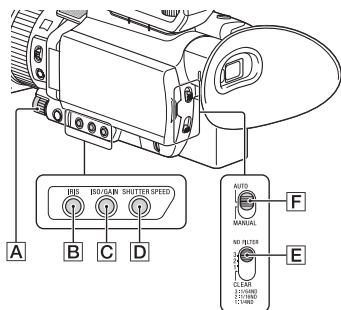

Note

- When you set the AUTO/MANUAL switch **F** to AUTO, iris, ISO sensitivity/gain, shutter speed, and white balance are adjusted automatically. You cannot adjust them manually.

Adjusting the iris

1 Set the AUTO/MANUAL switch **F** to MANUAL.

2 Press the IRIS button **B**.

The **A** or **E** next to the iris value disappears, and the iris value is highlighted.



Iris value

3 Turn the MANUAL dial **A** to adjust the value.

The light level increases the more that you open the aperture (decreasing F value). The light level decreases the more that you close the aperture (increasing F value).

To temporarily adjust automatically

Hold the ASSIGN5/IRIS PUSH AUTO button down.

The iris is adjusted automatically for as long as you hold the button down.

To adjust automatically

Press the IRIS button **B** while the iris value is highlighted.

The iris value disappears or **A** appears next to the iris value. When AE is fixed, **E** appears.

Adjusting the ISO sensitivity/ gain

Set whether to adjust the ISO sensitivity or gain using [ISO/GAIN SEL] (p. 103).

- 1 Set the AUTO/MANUAL switch [F] to MANUAL.

- 2 Press the ISO/GAIN button [C].

The [A] or [B] next to the ISO value or gain value disappears, and the value is highlighted.



ISO value or gain value

- 3 Turn the MANUAL dial [A] to adjust the value.

To adjust automatically

Press the ISO/GAIN button [C] while the ISO value or gain value is highlighted. The ISO value or gain value disappears, or [A] appears next to the ISO value or gain value. When AE is fixed, [B] appears.

Adjusting the shutter speed

- 1 Set the AUTO/MANUAL switch [F] to MANUAL.

- 2 Press the SHUTTER SPEED button [D].

The [A] or [B] next to the shutter speed value disappears, and the shutter speed value is highlighted.



Shutter speed value

- 3 Turn the MANUAL dial [A] to adjust the shutter speed.

When [60i] is selected:

You can select from 1/8 to 1/10000 (1/6 to 1/10000 when shooting at 24p).

When [50i] is selected:

You can select from 1/6 to 1/10000.

The denominator of the set shutter speed appears on the LCD screen. For example, [100] appears on the LCD screen when you set the shutter speed to 1/100 second. The larger the value on the LCD screen is, the faster the shutter speed is.

Tips

- It is difficult to focus automatically at a lower shutter speed. Manual focusing with your camcorder attached to a tripod is recommended.

- When recording under fluorescent lamps, sodium lamps, or mercury lamps, the picture may flicker or change colors, or may have horizontal bands of noise.
You may be able to improve the situation by adjusting the shutter speed to 1/100 if the power frequency of your area is 50 Hz, or 1/60 in a 60 Hz area.
- You can switch the shutter speed display between seconds and degrees ([SHUTTER DISPLAY], p. 120).

To adjust automatically

Press the SHUTTER SPEED button **[D]** while the shutter speed value is highlighted. The shutter speed value disappears, or **[A]** appears next to the shutter speed value. When AE is fixed, **[E]** appears.

Setting when [60i/50i SEL] is switched

The shutter speed may change after switching, depending on the current speed level. Refer to the following table for the shutter speed levels.

Level	60i/60p/30p	24p	50i/50p/25p
0	–	6	–
1	8	12	6
2	15	24	12
3	30	25	25
4	50	40	30
5	60	48	50
6	90	50	60
7	100	60	100
8	125	96	120
9	180	100	150
10	250	120	215
11	350	144	300
12	500	192	425
13	725	200	600
14	1000	288	1000
15	1500	400	1250
16	2000	576	1750
17	3000	1200	2500

Level	60i/60p/30p	24p	50i/50p/25p
18	4000	2400	3500
19	6000	4800	6000
20	10000	10000	10000

Adjusting the exposure

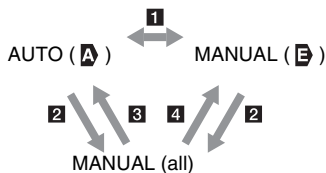

1 When you switch to AUTO/MANUAL in [SPOT METER] or [SPOT METER/ FOCUS].

2 When all of iris, ISO sensitivity/gain, and shutter speed are set to MANUAL.

3 When the last setting of the exposure is set to AUTO, and the iris, ISO sensitivity/gain, or shutter speed is set to AUTO.

4 When the last setting of the exposure is set to MANUAL, and the iris, ISO sensitivity/gain, or shutter speed is set to AUTO.

Note

- When you set the AUTO/MANUAL switch **[F]** to AUTO, or press [EXEC] on the [SPOT METER] or [SPOT METER/FOCUS] screen, the exposure is returned to AUTO.

Adjusting the light level (ND Filter)

You can set an appropriate brightness level using the ND filter switch **[E]** when the recording environment is too bright. The ND filters 1, 2 and 3 reduce the light level to about 1/4, 1/16 and 1/64, respectively.

If **ND1** flashes during the iris automatic adjustment, set the ND filter to 1. If **ND2** flashes during the iris automatic

Adjusting the brightness (Continued)

adjustment, set the ND filter to 2. If **ND3** flashes during the iris automatic adjustment, set the ND filter to 3.

The ND filter indicator will stop flashing and remain on the screen.

If **NDOFF** flashes, set the ND filter **[E]** to OFF. The ND filter icon will disappear from the screen.

⚡ Notes

- If you change the ND filter **[E]** during recording, the movie and sound may become distorted.
- When adjusting the iris manually, the ND filter icon does not flash even if the light level should be adjusted with the ND filter.
- If the camcorder cannot detect the ND filter position (OFF/1/2/3), **ND** flashes on the screen. Make sure that the ND filter is set correctly.

💡 Tip

- While recording a bright subject, diffraction may occur if you close the aperture further down, resulting in a fuzzy focus (this is a common phenomenon with video cameras). The ND filter **[E]** suppresses this phenomenon and gives better recording results.

Adjusting the color tone

Adjusting the white balance

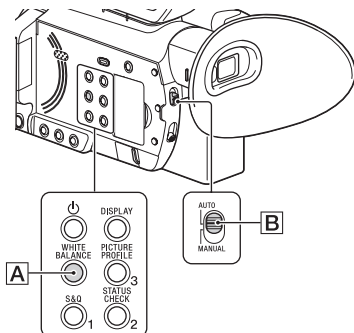

You can adjust and fix the white balance according to the lighting conditions of recording environment.

You can store white balance values in memory A (📁 A) and memory B (📁 B), respectively. Unless a white balance is readjusted, values will remain even after the power has been turned off.

When you select PRESET, [OUTDOOR], [INDOOR] or [MANU WB TEMP] is selected, according to which one you previously set with [WB PRESET] in the 📁 (CAMERA SET) menu.

1 Set the **AUTO/MANUAL** switch **[B]** to **MANUAL**.

2 Press the **WHITE BALANCE** button **[A]**.

The white balance value is highlighted.

3 Turn the **MANUAL** dial to select **PRESET, A, or B**.

■ Setting the A/B value

Select A or B for recording with the white balance setting stored in memory A or B.

■ To use the PRESET value of white balance

Select (CAMERA SET) → [WB PRESET] and select a desired setting.

Setting values	Example of recording conditions
Outdoor ([OUTDOOR])	<ul style="list-style-type: none"> When recording a night scene, neon lighting, fireworks, etc. When recording a sunrise, sunset, etc. Under daylight fluorescent lamp
Indoor ([INDOOR])	<ul style="list-style-type: none"> Where lighting conditions change, such as at a party place, etc. Under video light, such as in a studio, etc. Under a sodium or mercury lamp
Color temperature setting ([MANU WB TEMP])	<ul style="list-style-type: none"> You can set a desired color temperature between 2300K and 15000K with (CAMERA SET) → [WB TEMP SET] (default setting is 6500K).

To save the adjusted white balance value in memory A or B

- ① Set the AUTO/MANUAL switch to MANUAL.
- ② Press the WHITE BALANCE button to highlight the white balance value.
- ③ Turn the MANUAL dial to select A () or B ()

- ④ Press the MENU button.

- ⑤ Select (CAMERA SET) → [WB SET].

- ⑥ Frame a white object such as a piece of paper that fills the screen under the same lighting conditions as your subject.

- ⑦ Press the /SET button.

The adjusted value is stored in A or B. The stored color temperature appears for about 3 seconds.

Tip

- If [WB SET] is assigned to an ASSIGN button, the adjusted value is stored by pressing the ASSIGN button when the shooting screen is displayed, instead of performing step ④.

Note

- When a white balance adjustment value has not been obtained successfully, A or B starts flashing slowly. Adjust the subject appropriately and set the shutter speed to auto or around 1/60 (when [60i] is selected)/1/50 (when [50i] is selected), then try adjusting the white balance again.

To restore automatic adjustment

Press the WHITE BALANCE button .

Note

- When you set the AUTO/MANUAL switch to AUTO, iris, ISO sensitivity/gain, shutter speed, and white balance are adjusted automatically. You cannot adjust manually.

Using Direct Menu

Direct Menu allows you to change settings directly while recording using the **▲/▼/◀/▶/SET** buttons.

The following items can be configured.

- Focus value (p. 35)
- AE shift level value (p. 104)
- Iris value (p. 43)
- ISO sensitivity/gain value (p. 44)
- Shutter speed value (p. 44)
- White balance value (p. 46)

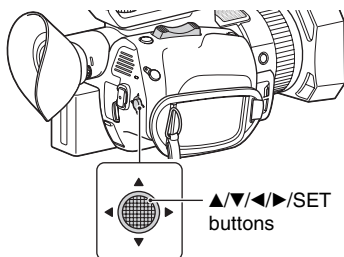

You can assign this function to an ASSIGN button.

For details about function assignment operation to an ASSIGN button, see “Assigning functions to the ASSIGN buttons” (p. 64).

1 Press the ASSIGN button to which Direct Menu is assigned.

After entering Direct Menu mode, a cursor (underline) is displayed for items along the bottom of the LCD screen.

- Orange cursor indicates the selected item.
- White cursor indicates selectable items.

For example, the iris value **3** is selected in the following diagram.

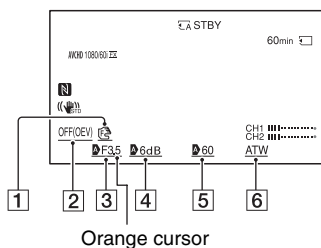

- 1 Focus value
 - 2 AE shift level value
 - 3 Iris value
 - 4 ISO sensitivity/gain value
 - 5 Shutter speed value
 - 6 White balance value
-
- 2** Move the **▲/▼/◀/▶/SET** button left/right to move the orange cursor to select the target item to set.
-
- 3** When **A** (auto) appears for the item to set, moving the **▲/▼/◀/▶/SET** button up/down clears the **A** mark.

4 Press the ▲/▼/◀/▶/SET button to apply the setting.

The set value is highlighted in reverse black and white, allowing you to change the value.

The following diagram shows an example of changing the shutter speed value.

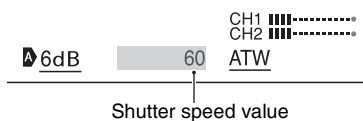

5 Move the ▲/▼/◀/▶/SET button up/down to display the desired value.

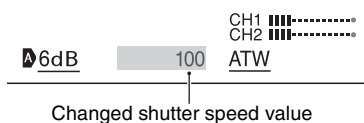

- If an item (such as iris value or focus value) is changed using buttons or switches while Direct Menu is displayed, the Direct Menu may be canceled.

6 To set another item, repeat steps 3 to 5 to move the orange cursor using the ▲/▼/◀/▶/SET button.

7 When all desired values are displayed, press the ▲/▼/◀/▶/SET button.

The setting is applied, and Direct Menu mode ends.

Notes

- Direct Menu is not available when using the following functions (includes operation using operation buttons and ASSIGN buttons).
 - During menu display
 - During playback mode
 - S&Q MOTION
 - SUPER SLOW MOTION
 - FOCUS MAGNIFIER
 - SPOT METER/FOCUS
 - SPOT METER
 - SPOT FOCUS
 - Focus area setting
 - VOLUME
 - Smartphone operation (CTRL W/ SMARTPHONE)
 - LAST SCENE REVIEW
 - STREAMING
 - RTMP/RTMPS
 - USTREAM
 - WIRELESS TC LINK

Audio setup

Recording sound from the internal microphone

You can record sound in stereo using the camcorder's internal microphone.

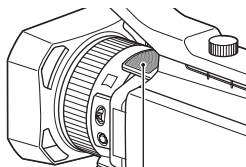

Internal microphone

Select [INT MIC] in the [MIC SELECT] menu.

Tip

- To reduce wind noise, set [INT MIC WIND] to [ON].

Recording sound from an external audio device

The jacks, switches and dials shown below allow you to set the sound that is recorded. See page 10 for details about connecting a microphone.

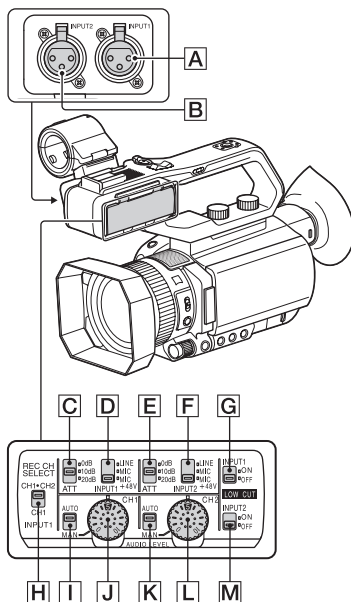

External audio input jacks

- A**: INPUT1 jack
- B**: INPUT2 jack

Audio source switches

- D**: INPUT1 (LINE/MIC/MIC+48V) switch
- E**: INPUT2 (LINE/MIC/MIC+48V) switch

Audio source level controls

- C**: ATT (INPUT1) switch
- E**: ATT (INPUT2) switch

Recording channel switch

- H**: REC CH SELECT (INPUT1) switch

Audio level controls

- I**: AUTO/MAN (CH1) switch
- J**: AUDIO LEVEL (CH1) dial
- K**: AUTO/MAN (CH2) switch

[L]: AUDIO LEVEL (CH2) dial

Wind noise reduction switches

[G]: LOW CUT (INPUT1) switch

[M]: LOW CUT (INPUT2) switch

When using a microphone with XLR-type connector (sold separately) or external audio device (such as a mixer), configure the settings as described below.

1 Select the audio input source.

- Set the INPUT1/INPUT2 (LINE/MIC/MIC+48V) switch (**[D]** or **[F]**) based on the device connected to INPUT1 jack **[A]**/INPUT2 jack **[B]**.

Connected device	Switch position
External audio device (such as mixer)	LINE
Dynamic microphone or microphone with built-in battery	MIC
+48V powered (phantom power) microphone	MIC+48V

Notes

- If the switch is set to MIC+48V and you connect a device that is not compatible with +48V power, it may damage the connected device. Check the switch before connecting the device.
- To prevent unwanted noise when no audio device is connected to the INPUT1 or INPUT2 jack, set the INPUT1/INPUT2 (LINE/MIC/MIC+48V) switch (**[D]** or **[F]**) to LINE.

2 Set the microphone input level.

When the INPUT1/INPUT2 (LINE/MIC/MIC+48V) switch (**[D]** or **[F]**) is set to MIC or MIC+48V, the input level can be set using the ATT (INPUT1/INPUT2) switch (**[C]** or **[E]**). Adjust the setting based on the sensitivity of the microphone.

ATT 0dB: -60dBu

ATT 10dB: -50dBu



ATT 20dB: -40dBu

Note

- The input level is fixed to +4dBu when the INPUT1/INPUT2 (LINE/MIC/MIC+48V) switch (**[D]** or **[F]**) is set to LINE. The input level does not change, even if you change the ATT switch setting.

3 Select the channel to record.

With the REC CH SELECT (INPUT1) switch **[H]**, select the channel to record.

REC CH SELECT (INPUT1) switch setting	Sound recorded to CH1 and CH2
CH1•CH2	INPUT1  CH1 CH2
CH1	INPUT1  CH1
	INPUT2  CH2

Tip

- When using a stereo microphone with two XLR (3-pin) plugs, connect the INPUT1 jack **[A]** to the left channel, connect the INPUT2 jack **[B]** to the right channel, and set the REC CH SELECT (INPUT1) switch **[H]** to CH1.

Recording sound from a Multi Interface Shoe compatible microphone (sold separately)

You can record audio with a Multi Interface Shoe-compatible microphone.

1 Connect the Multi Interface Shoe compatible microphone (sold separately) to the Multi Interface Shoe.

Audio setup (Continued)

-
- 2 Select **[MI SHOE MIC]** in the **[MIC SELECT]** menu.
-

Recording sound from an external microphone (sold separately)

You can record sound in stereo using an external microphone (sold separately).

-
- 1 Connect the external microphone (sold separately) to the MIC jack (PLUG IN POWER).
-

- 2 Select **[STEREO MINI MIC]** in the **[MIC SELECT]** menu.
-

Adjusting the audio level from the INPUT1 and INPUT2 jacks

You can adjust the audio level for the sound that is input from the INPUT1 and INPUT2 jacks.

-
- 1 Set the **AUTO/MAN** switch to **MAN** for the channel that you want to adjust (CH1 or CH2).
-

- 2 Turn the **AUDIO LEVEL** dial to adjust the audio level.

Use headphones or an audio level meter to check that the audio level is appropriate.

To restore automatic adjustment

- Set the **AUTO/MAN** switch to **AUTO** to restore automatic adjustment for sound that is input from the INPUT1 and INPUT2 jacks.

Adjusting the audio level from the internal microphone or an external microphone (sold separately)

You can adjust the audio level for the sound that is input from the internal microphone or an external microphone (sold separately).

-
- 1 Select **[MANUAL]** in the **[REC LEVEL MODE]** menu in **[AUDIO REC LEVEL]**.
-

- 2 During recording or standby, adjust the microphone volume in the **[MANUAL REC LEVEL]** menu in **[AUDIO REC LEVEL]**.
-

To restore automatic adjustment

- Select **[NORMAL]** or **[HIGH]** in the **[REC LEVEL MODE]** menu in **[AUDIO REC LEVEL]**.

Useful functions

Selecting suitable settings automatically (auto mode setting)

You can make optimal recordings in various situations.

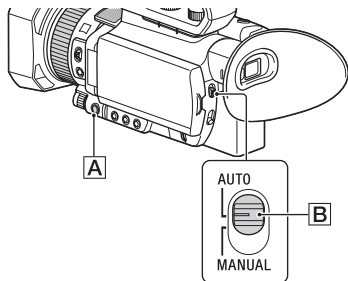

1 Set the **AUTO/MANUAL** switch **B** to **AUTO**.

2 Press the **MENU** button **A**.

3 Select **CAMERA SET** → **AUTO MODE SET**.

4 Select **[AUTO]**, **[INTELLIGENT AUTO]**, or **[SCENE SELECTION]**, then press the dial.

Note

- Fixed to [AUTO] if the file format is XAVC S 4K.
- When you select [INTELLIGENT AUTO], [STEADYSHOT] is set to [ACTIVE], and the angle of view shifts 1.08 times toward the telephoto side.

Scenes detected by INTELLIGENT AUTO

Face detection: (Portrait), (Baby)

Scene detection: (Backlight), (Landscape), (Night Scene), (Spotlight), (Low Light), (Macro)

Camera-shake detection: (Walk), (Tripod)

To use [SCENE SELECTION]

① Select **CAMERA SET** → **SCENE SELECTION SET**.

② Select the desired setting.

Setting values	Recording conditions
Night Scene ([NIGHT SCENE])	Shoots a night view with a proper exposure, using a tripod (sold separately).
Sunrise & Sunset ([SUNRISE & SUNSET])	Shoots the scenes under the glow of sunset/sunrise vividly.
Fireworks ([FIREWORKS])	Shoots fireworks with optimal exposure.
Landscape ([LANDSCAPE])	Shoots distant subjects clearly. This setting also prevents your camcorder from focusing on any glass or mesh in windows between the camcorder and the subject.
Portrait ([PORTRAIT])	Brings out the subject, such as people or flowers, while creating a soft background.
Spotlight ([SPOTLIGHT])	Prevents people's faces from appearing excessively white when subjects are lit by strong light.
Beach ([BEACH])	Takes the vivid blue of the ocean or a lake.

Useful functions (Continued)

🔊 Notes

- When [SCENE SELECTION SET] is set, the following settings are canceled.
 - White balance
 - Iris
 - Shutter speed
 - ISO sensitivity/gain
- When [SCENE SELECTION SET] is set, the focus area is fixed to [WIDE].

Shooting in dimly lit locations (LOW LUX)

You can shoot bright video, even in low light conditions, such as outdoor locations with limited street lighting or dimly lit indoors, by automatically optimizing the gain and shutter speed.

🔊 Note

This function is available only when the AUTO/MANUAL switch is set to AUTO and [AUTO MODE SET] is set to [AUTO].

1 Set the AUTO/MANUAL switch AUTO.

2 Press the MENU button.

3 Select (CAMERA SET) → [LOW LUX] → [ON].

-  is displayed.
- To cancel, set [LOW LUX] to [OFF].

Shooting in dark conditions (NIGHTSHOT)

You can shoot scenes under very dark conditions by turning on the infrared light. The infrared light does not turn on if [NIGHTSHOT LIGHT] is set to [OFF].

1 Press the MENU button.

2 Select (CAMERA SET) → [NIGHTSHOT] → [ON].

-  is displayed.
- To cancel, set [NIGHTSHOT] to [OFF].

🔊 Notes

- NIGHTSHOT can only be used when the AUTO/MANUAL switch is set to AUTO.
- NIGHTSHOT uses infrared light. Make sure that your finger does not cover the NightShot light when shooting.
- Remove the lens hood.
- Do not use NIGHTSHOT in bright conditions. Doing so may damage the camcorder.

Customizing the picture quality (Picture Profile)

You can customize the picture quality by adjusting picture profile items such as [GAMMA] and [DETAIL]. You can make adjustments for the time of day, weather conditions, or just personal preference. Press the ASSIGN3/PICTURE PROFILE button to display the picture profile selection screen.

Select a picture profile number to enable shooting with the selected picture profile settings (p. 127).

You can change the settings of the picture profile.

Picture quality settings for different recording conditions have been stored in [PP1] through [PP10] as default settings. [PP4] is set for the picture profile by default.

Picture profile number	Example setting
PP1	Example settings of a color tone with [STANDARD] gamma
PP2	Example settings of a color tone with [STILL] gamma
PP3	Example settings of natural color tone with [ITU709] gamma
PP4	Example settings of a color tone that is faithful to [ITU709]
PP5	Example settings of pictures recorded on cinema color negative film
PP6	Example settings of pictures screened with cinema color print film
PP7	Example settings when shooting with [S-LOG2] gamma in [S-GAMUT] color mode.
PP8	Example settings when shooting with [S-LOG3] gamma in [S-GAMUT3.CINE] color mode.
PP9	Example settings when shooting with [S-LOG3] gamma in [S-GAMUT3] color mode.
PP10	Example settings when shooting with [HLG2] gamma in [BT.2020] color mode.

To change the picture profile

You can change the settings stored in [PP1] through [PP10].

- Press the ASSIGN3/PICTURE PROFILE button.

- Select the picture profile number with the settings you want to change.
- Select [SETTING].
- Select the item to adjust.
- Adjust the picture quality.
- Repeat steps ④ and ⑤ to adjust other items.
- Select [↩ RETURN] → [OK].
The picture profile indicator is displayed.

Copying the picture profile settings to another picture profile number

You can change settings by copying a picture profile. This is useful when you want to register similar settings.

- Press the ASSIGN3/PICTURE PROFILE button.
- Select the source picture profile number to copy.
- Select [SETTING] → [COPY].
- Select the destination picture profile number.
- Select [YES] → [↩ RETURN] → [OK].

Resetting a picture profile

You can reset changed picture profile settings by the picture profile number. You cannot reset all picture profile settings at once.

- Press the ASSIGN3/PICTURE PROFILE button.
- Select the picture profile number that you want to reset to default settings.
- Select [SETTING] → [RESET] → [YES] → [↩ RETURN] → [OK].

Tip

Connect your camcorder to a TV or monitor, and adjust the picture quality while observing the picture on the TV or monitor screen.

Shooting in high dynamic range (HDR)

Reproduction of brightness over a wider range than previously available is supported by applying an HDR-compatible picture profile. The camcorder supports Hybrid Log-Gamma (HLG), with four selectable gamma settings.

The [HLG] setting is equivalent to ITU-R BT.2100. The [HLG1], [HLG2], and [HLG3] settings enable images to be reproduced with a wider dynamic range without images that appear unnatural, as can arise in existing camera image reproduction.

Shooting using HDR-compatible picture profile

An HDR setting is registered in [PP10] by default for shooting in HDR.

[HLG], [HLG1], [HLG2], and [HLG3] can also be used in [PP1] to [PP9].

- Press the MENU button, and select  (CAMERA SET) → [PICTURE PROFILE] → [PP10].

Picture profile number	Example setting
PP10	Setting for shooting in HDR

- Adjust the picture profile items, as required.
- Press the START/STOP button (or the handle record button).
Movies shot in HDR are recorded on the memory card.

Notes

- XAVC S format recording
When recording HDR video in XAVC S format on the camcorder, the color space, gamma, and other metadata required for HDR playback and display are stored in the video file.
On devices used for playback and display that support the metadata, the video is displayed

automatically with the appropriate settings. On devices that do not support the metadata, manual configuration is required.

- AVCHD format recording
AVCHD format recordings do not support HDR metadata. For appropriate playback and display of HDR, manual configuration is required.

Picture profile HDR-related items

[GAMMA] items

(Default setting in bold)

Item	Description
[HLG]	Setting equivalent to ITU-R BT.2100.
[HLG1]	Setting that provides greater noise suppression than [HLG2]. However, the dynamic range that can be shot is narrower.
[HLG2]	Setting with balance between dynamic range and noise suppression.
[HLG3]	Setting that provides wider dynamic range than [HLG2]. However, the noise level rises.

[HLG1], [HLG2], and [HLG3] all use the same gamma curve characteristic. Only the dynamic range and noise suppression characteristics differ.

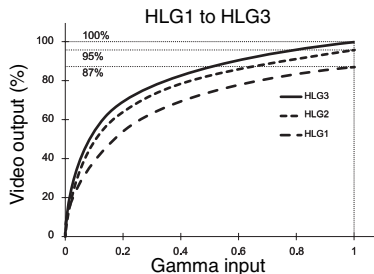

Notes

- The maximum value of the video output varies depending on whether [HLG1], [HLG2], or [HLG3] is selected ([HLG1]: 87%, [HLG2]:

95%, [HLG3]: 100%). Test shooting beforehand is recommended to prevent use of an inappropriate setting during actual shooting.

- The following limitations apply when [HLG], [HLG1], [HLG2], or [HLG3] is selected.
 - If [MODE] is set to AUTO for [KNEE], the [KNEE] setting becomes disabled.
 - [COLOR MODE] can only be set to [BT.2020] or [709].
 - The [BLACK GAMMA] setting is disabled.
 - [AUTO BACK LIGHT] cannot be used.

[COLOR MODE] items

(Default setting in bold)

Item	Description
[BT.2020]	Standard color tone when [HLG], [HLG1], [HLG2], or [HLG3] is selected for [GAMMA].
[709]	Color tone for recording HDTV format (BT.709) color when [HLG], [HLG1], [HLG2], or [HLG3] is selected for [GAMMA].

Note

Color bars are not output correctly when [BT.2020] is selected.

Using the gamma display assist function

The viewfinder and LCD screen of the camcorder do not support HDR, and so are not appropriate for displaying HDR. However, they can display an image to aid shooting using the gamma display assist function.

The gamma display assist function affects only the monitoring video or playback video displayed in the viewfinder or on the LCD screen. The recorded video and output video are not affected.

- ① Press the MENU button, and select  (DISPLAY SET) menu → [GAMMA DISP ASSIST] → [ON/OFF] → [ON].

- ② Select [GAMMA DISP ASSIST] → [TYPE].

- ③ Select one of the following.
(Default setting in bold)

Item	Description
[AUTO]	Shooting screen: Automatically corrects the picture according to the picture profile setting. Playback screen: For AVCHD and XAVC S non-HLG files, automatically corrects the picture according to the current picture profile setting. For XAVC S HLG files, automatically corrects the picture according to the gamma and color mode of the playback image. Thumbnail screen: Maintains the recent setting (shooting/playback).
S-LOG2→	Converts S-LOG2 to ITU-709(800%) for display.
S-LOG3→	Converts S-LOG3 to ITU-709(800%) for display.
[HLG (BT.2020)]	Applies suitable correction for when [GAMMA] is HLG and [COLOR MODE] is set to [BT.2020].
[HLG(709)]	Applies suitable correction for when [GAMMA] is HLG and [COLOR MODE] is set to [709].





Tips

- When the camcorder is powered using the battery pack, changing the brightness of the LCD will make the HDR image easier to monitor. In the DISPLAY SET menu, select [LCD BRIGHT] → [BRIGHT].

Useful functions (Continued)

Icon display

When the gamma display assist function is ON, the following icons are displayed on the shooting screen and playback screen.

Icon	Meaning
	[S-LOG2→709(800%)] in use
	[S-LOG3→709(800%)] in use
	[HLG(BT.2020)] in use
	[HLG(709)] in use

Playing video recorded in HDR on the camcorder

You can play back video recorded in HDR on the camcorder.

When playing files recorded in XAVC S 4K or XAVC S HD format, an “HLG” icon is displayed on the thumbnail screen and playback screen (see following diagrams).

Notes

- An “HLG” icon is not displayed when playing AVCHD format files recorded in HDR.
- To view HDR video on a TV, connect a Sony HDR (HLG) compatible TV to the camcorder via USB.

When a TV (or HDR (HLG) compatible monitor) is connected using HDMI or SDI, the image quality settings of the TV must be adjusted manually for appropriate display. Set the image quality settings of the TV to a gamma setting that supports HLG and a color mode setting that supports BT.2020 or 709.

Thumbnail screen

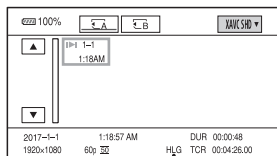

* Only files recorded in XAVC S format.

Playback screen

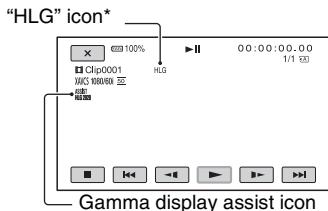

* Only files recorded in XAVC S format.

Limitations on HDR files recorded in non-XAVC S formats

The following limitations apply on files recorded in formats other than XAVC S 4K or XAVC S HD.

- The fact that the recording used HLG is not registered in metadata.
- The “HLG” icon is not displayed on the thumbnail screen and playback screen.

Setting time data

The camcorder records movies accompanied by time data, such as timecode and user bits.

Setting the timecode

- ① Press the MENU button, and select  (TC/UB SET) → [TC PRESET].

- ② Select [PRESET].
- ③ Select the first two digits. You can set the timecode within the following range.
When [60i] is selected:
00:00:00:00 to 23:59:59:29
 - When setting 24p, you can set the last 2 timecode digits of the frames in multiples of 4, between 0 and 23.
 When [50i] is selected:
00:00:00:00 to 23:59:59:24
- ④ Set other digits by repeating step ③.
- ⑤ Select [OK].

To reset the timecode

Select [RESET] in step ② of “Setting the timecode” to reset the timecode (00:00:00:00).

To reset the timecode using the Wireless Remote Commander

Press the TC RESET button on the Wireless Remote Commander to reset the timecode (00:00:00:00).

Setting the user bits

- ① Press the MENU button, and select  (TC/UB SET) → [UB PRESET].
- ② Select [PRESET].
- ③ Select the first two digits.
- ④ Set other digits by repeating step ③.
- ⑤ Select [OK].

To reset the user bits

Select [RESET] in step ② of “Setting the user bits” to reset the user bits (00 00 00 00).

Recording with the Slow & Quick Motion function

By recording with a frame rate that is different from the playback frame rate, you can record images to be played back as slow motion or quick motion images. The images recorded with the Slow & Quick Motion function will appear smoother than slow or fast-forward playback of images recorded at normal speed.

Preparation

You must set the recording format and frame rate. The playback speed is determined by the combination.

- ① Press the MENU button, and select  (CAMERA SET) → [SLOW & QUICK] → [S&Q MOTION] → [REC FORMAT].
- ② Set the recording format.
- ③ Select [FRAME RATE].
- ④ Set the frame rate.

To record with the Slow & Quick Motion function

- ① Press the ASSIGN1/S&Q button repeatedly to display [S&Q MOTION] on the screen.
- ② Press the START/STOP button. Slow & Quick Motion recording starts.
- ③ To stop, press the START/STOP button again.

Tip

- You can also press the MENU button and select  (CAMERA SET) → [SLOW & QUICK] → [S&Q MOTION] → [EXECUTE] to switch to Slow & Quick Motion shooting mode.

To change the frame rate setting

Press and hold the ASSIGN1/S&Q button for about 1 second, then change the value.

Useful functions (Continued)

Pressing the **▲/▼/◀/▶/SET** button, or pressing and holding the **ASSIGN1/S&Q** button again for about 1 second restores the previous setting.

To cancel Slow & Quick Motion recording

Press the **ASSIGN1/S&Q** button or the **MENU** button during standby.

Notes

- The supported memory cards that can be used vary depending on the file format (p. 27).
- In quick motion recording, the camcorder may continue recording for a few more seconds after you press the **START/STOP** button to stop recording (up to 30 seconds). Do not operate your camcorder while the **[REC]** indicator is flashing on the screen, and wait till it turns to **[STBY]**.
- After you stop recording, your camcorder continues recording till it completes writing 0.5 seconds unit of data.
- When you are recording with a slow frame rate, the camcorder may continue recording for a few more seconds after you press the **START/STOP** button to stop recording.
- You cannot change the frame rate during Slow & Quick Motion recording. To change the frame rate, first stop Slow & Quick Motion recording.
- The timecode is recorded in **[REC RUN]** mode (p. 123).
- Slow & Quick Motion mode is automatically canceled when the camcorder is turned off, but the frame rate setting is retained.
- You cannot record sound during Slow & Quick Motion recording.
- You cannot use the Slow & Quick Motion function for simultaneous recording.
- The maximum continuous recording time in Slow & Quick Motion has the same limitations as for normal recording. The maximum continuous recording time will vary depending on the frame rate setting.
- For details about Slow & Quick Motion limitations, see “Slow & Quick Motion and Super Slow Motion recording limitations” (p. 152).

Slow-motion recording at high frame rate (HFR)

You can record at high frame rate when the file format is **XAVC S HD**.

Preparation

The playback speed is determined by the recording format.

- ① Press the **MENU** button, and select  (**CAMERA SET**) → **[SLOW & QUICK]** → **[S&Q MOTION]** → **[HIGH FRAME RATE]** → **[ON]**.
- ② Select **[REC FORMAT]**.
- ③ Select a recording format.
In this state, starting to record in Slow & Quick Motion will record at high frame rate.

The frame rate is fixed to the following value.

When **[60i]** is selected: 120

When **[50i]** is selected: 100

For details about shooting, see “To record with the Slow & Quick Motion function” (p. 59).

Notes

- The camcorder may continue recording for a few more seconds after you press the **START/STOP** button to stop recording.
- The timecode is recorded in **[REC RUN]** mode.

Tip

- The **[HIGH FRAME RATE]** ON/OFF setting cannot be switched using the **ASSIGN1/S&Q** button.

Recording with the Super Slow Motion function

By recording with a frame rate that is higher than the playback frame rate, you can record images to be played back as

slow motion images. The images recorded with the Super Slow Motion function will appear smoother than slow playback of images recorded at normal speed.

Preparation

You must set the recording format and frame rate. The playback speed is determined by the combination. You also must set the record timing.

- 1 Press the MENU button, and select  (CAMERA SET) → [SLOW & QUICK] → [SUPER SLOW MOTION].
- 2 Select [REC FORMAT], and select the recording format.
- 3 Select [FRAME RATE], and select the frame rate.
- 4 Select [REC TIMING], and select the record timing.

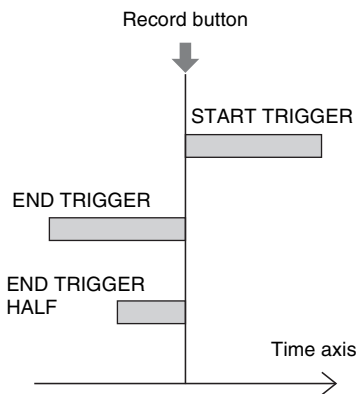

To record with the Super Slow Motion function

- 1 Press the ASSIGN1/S&Q button repeatedly to display [SUPER SLOW MOTION] on the screen.

- 2 Press the START/STOP button. Super Slow Motion recording starts.



Tip

- You can also press the MENU button and select  (CAMERA SET) → [SLOW & QUICK] → [SUPER SLOW MOTION] → [EXECUTE] to switch to Super Slow Motion shooting mode.

To determine the recording time manually

When [REC TIMING] is set to [START TRIGGER], press the START/STOP button again while recording to stop recording.

To change the frame rate setting

Press and hold the ASSIGN1/S&Q button for about 1 second, change the setting using the /SET button, and then press the /SET button to apply the setting.

When you want to abort recording

Select [Cancel] on the screen during recording to abort recording. Recording stops and the captured content is not saved. This is useful when you want to shoot again immediately.

To cancel Super Slow Motion recording

Press the ASSIGN1/S&Q button or the MENU button during standby.

Estimated recording time for [REC TIMING] and [FRAME RATE] settings

The recording time varies depending on the record timing and frame rate settings. The following table shows estimates of recording time for various values.

Useful functions (Continued)

When [60i] is selected

FRAME RATE	REC TIMING		
	START TRIGGER	END TRIGGER	END TRIGGER HALF
960	Approx. 3 sec.	Approx. 3 sec.	Approx. 1 sec.
480	Approx. 4 sec.	Approx. 4 sec.	Approx. 2 sec.
240	Approx. 5 sec.	Approx. 5 sec.	Approx. 2 sec.

When [50i] is selected

FRAME RATE	REC TIMING		
	START TRIGGER	END TRIGGER	END TRIGGER HALF
1000	Approx. 3 sec.	Approx. 3 sec.	Approx. 1 sec.
500	Approx. 4 sec.	Approx. 4 sec.	Approx. 2 sec.
250	Approx. 5 sec.	Approx. 5 sec.	Approx. 2 sec.

🔊 Notes

- The supported memory cards that can be used vary depending on the file format (p. 27).
- In Super Slow Motion recording, the camcorder may continue recording after you press the START/STOP button to stop recording (up to 3 minutes). Do not operate your camcorder while the [REC] indicator is flashing on the screen, and wait till it turns to [STBY].
- After you stop recording, your camcorder continues recording till it completes writing 0.5 seconds unit of data.
- The shutter value may not be displayed correctly when recording in Super Slow Motion if [SHUTTER DISPLAY] is set to [DEGREE] (p. 120).
- Available only when the AUTO/MANUAL switch is set to MANUAL. Note that iris, ISO sensitivity/gain, and shutter speed are fixed to manual.
- When the [FRAME RATE] is set to [960] ([1000]), the image displayed and recorded shifts approximately 1.35 times toward the telephoto side.

- When the [FRAME RATE] is set to [480] or [960] ([500] or [1000]), the picture will be slightly degraded relative to normal shooting.
- Changing the ISO sensitivity/gain, shutter speed, or white balance will cause degradation of the image on the LCD screen, but the camera settings in force when shooting ends are applied to the recorded image. For details about displaying camera data, see page 67.
- To change the frame rate setting, first stop recording.
- The timecode is recorded in [REC RUN] mode (p. 123).
- Super Slow Motion mode is automatically canceled when the camcorder is turned off, but the [FRAME RATE] setting is retained.
- Flicker correction has no effect.
- You cannot record sound.
- The auto focus function is not supported.
- Shutter speeds slower than the frame rate cannot be selected.
- Super Slow Motion recording is not supported when the file format is XAVC S 4K.
- For details about Super Slow Motion limitations, see “Slow & Quick Motion and Super Slow Motion recording limitations” (p. 152).

Reviewing the most recently recorded scene (Last Scene Review)

You can review the most recently recorded scene on the LCD screen.

You can assign this function to an ASSIGN button.

For details about function assignment operation to an ASSIGN button, see “Assigning functions to the ASSIGN buttons” (p. 64).

After you stop recording, press the ASSIGN button to which [LAST SCENE REVIEW] is assigned.

The camcorder plays from the start to the end of the most recently recorded scene, then returns to standby mode.

To stop reviewing the last scene

Press the ASSIGN button to which [LAST SCENE REVIEW] is assigned during playback. The camcorder returns to standby mode.

Note

- If you edit the movie or remove the recording media after you stop recording, the Last Scene Review function may not work correctly.

Assigning functions to the ASSIGN buttons

Some functions can be assigned to the ASSIGN buttons.

You can assign a single function to each of the ASSIGN1 to 6 buttons.

Function assignments are performed using  (OTHERS) → [ASSIGN BUTTON].

For details about each function, see “Menu items” (p. 101).

Default assigned functions

- ASSIGN1: S&Q MOTION (p. 59)
- ASSIGN2: STATUS CHECK (p. 68)
- ASSIGN3: PICTURE PROFILE (p. 54)
- ASSIGN4: FOCUS MAGNIFIER (p. 38)
- ASSIGN5: IRIS PUSH AUTO (p. 43)
- ASSIGN6: – (no function)

Functions you can assign to the ASSIGN buttons

- – (no function)
- LOW LUX (p. 54)
- FOCUS MAGNIFIER (p. 38)
- LAST SCENE REVIEW (p. 62)
- WHITE BALANCE (p. 46)
- WB PRESET (p. 47)
- WB SET (p. 47)
- AE SHIFT (p. 104)
- D. EXTENDER (p. 104)
- STEADYSHOT (p. 104)
- FOCUS AREA (p. 105)
- FOCUS POSITION (p. 36)
- AF DRIVE SPEED (p. 36)
- AF TRACKING DEPTH (p. 37)
- AF SUBJ. SWITCH. SENS. (p. 37)
- FACE DETECTION (p. 39)
- S&Q MOTION (p. 59)
- AUTO MODE SET (p. 53)
- SCENE SELECTION SET (p. 53)
- NIGHTSHOT (p. 54)
- IRIS PUSH AUTO (p. 43)
- SPOT METER/FOCUS (p. 109)
- SPOT METER (p. 109)
- SPOT FOCUS (p. 109)
- COLOR BAR (p. 110)
- DIRECT (p. 48)
- MENU (p. 100)
- PICTURE PROFILE (p. 54)
- VOLUME (p. 116)
- HISTOGRAM (p. 118)
- ZEBRA (p. 118)
- PEAKING (p. 118)
- PHASE AF FRAMES (p. 118)
- MARKER (p. 119)
- CAMERA DATA DISPLAY (p. 120)
- AUDIO LEVEL DISPLAY (p. 120)
- DATA CODE (p. 67)
- GAMMA DISP ASSIST (p. 57)
- TC/UB DISPLAY (p. 122)
- SMARTPHONE CONNECT (p. 74)
- STREAMING (p. 83)
- RTMP/RTMPS (p. 86)
- USTREAM (p. 89)
- STREAM OPERATION (p. 83)
- WIRELESS TC LINK (p. 92)
- STATUS CHECK (p. 68)
- REC LAMP (p. 126)
- THUMBNAIL (p. 65)

Playback**1** Insert a memory on which a movie has been recorded, and press the **THUMBNAIL** button (p. 15).

The THUMBNAIL screen appears after a few seconds.

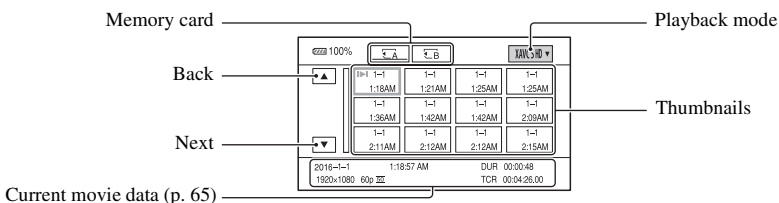

- You can turn on or off the date and time display on the thumbnails by pressing the DISPLAY button.
- Icons may also be displayed on thumbnails.

Proxy recording (p. 42) icon

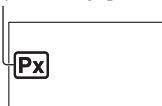

Protected (p. 96) icon

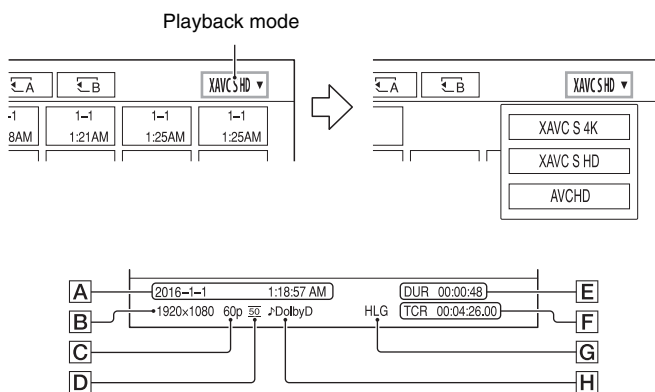
**2** Select the target memory card and playback mode, then touch the movie thumbnail twice to play back.

Playback (Continued)

A Date and time of recording start

B Resolution

C Frame rate

D Recording mode

E Recording time

F Timecode of recording start

Timecode will not be displayed correctly when you play back a memory card with no timecode, or a memory card with timecode that your camcorder does not support.

G HLG recording

Displayed when recording movies using HLG gamma.

H DOLBY DIGITAL recording

Displayed when audio is recorded in Dolby Digital format.

- ▶| appears with the movie that has been most recently played back or recorded. Selecting it will continue playback from the previous time.

Playback starts.

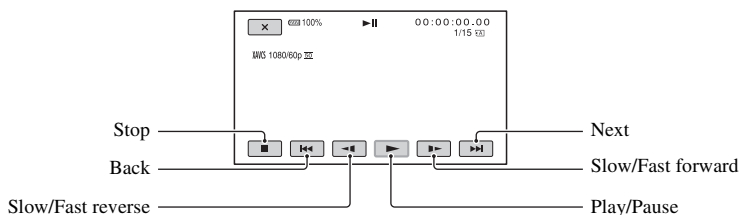

💡 Tips

- When playback from the selected movie reaches the last movie, the screen returns to the THUMBNAIL screen.
- Select ◀|/▶ during pause to play back movies slowly.
- The playback speed increases based on the number of times that you select ◀|/▶.

To adjust the volume

Press the MENU button and select 🎵 (AUDIO SET) → [VOLUME] to adjust the volume.

To return to recording mode

Press the THUMBNAIL button.

On playing back movies

- Movies recorded using this camcorder may not be played back normally on devices other than this camcorder. Also, movies recorded on other devices may not play back properly on this camcorder.

Changing/checking the settings in your camcorder

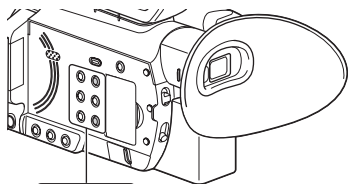

Changing the screen display

You can display information such as timecode, etc., on the image.

Press the **DISPLAY** button (A).

The screen indicators turn on (displayed) ↔ off (not displayed) each time you press the button. In recording mode, the screen changes in the order, detailed display → simple display → no display with each press of the button.

Tip

- You can display the screen indicators during playback on a TV by setting [DISPLAY OUTPUT] to [ALL OUTPUT] (p. 122).

Displaying recording data (Data Code)

You can display information, including date, time and camera data automatically stored during recording on the screen during playback.

1 Press the **MENU** button during playback.

2 Select **DISPLAY SET** → [DATA CODE].

3 Select the information you want to display.

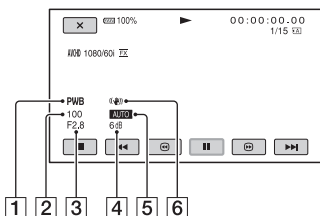

1 White balance

PWB appears during the playback of movies recorded with [MANU WB TEMP].

2 Shutter speed

3 Iris

4 ISO sensitivity/gain

5 Exposure

AUTO appears during playback of the movie recorded with the iris, ISO sensitivity/gain, and shutter speed automatically adjusted. **MANUAL** appears during playback of the movie

Changing/checking the settings in your camcorder (Continued)

recorded with the iris, ISO sensitivity/gain, and shutter speed manually adjusted.

6 Camera shake correction (STEADYSHOT)

Note

- When you play back the memory card on other devices, the camera data may be displayed incorrectly. Confirm the correct camera data on your camcorder.

Checking the settings in your camcorder (Status Check)

Press the ASSIGN2/STATUS CHECK button **B** to check the settings of the following items.

- Wireless TC LINK information (p. 92)
- Audio setup (p. 116)
- Output signal setup (p. 113)
- Functions assigned to the ASSIGN buttons (p. 64)
- Camera setup (p. 103)
- Record button setup (p. 32)
- Memory card information
- Battery information

• Wireless TC LINK

You can check the last synchronization time.

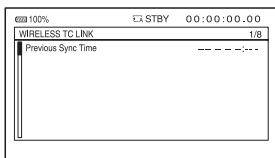

• Record button setup

You can check the record button setting.

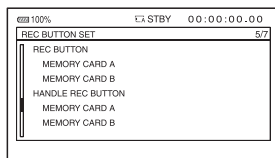

• Memory card information

You can check the estimated used and free spaces.

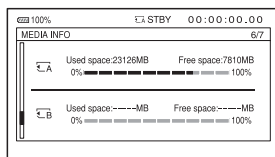

• Battery Info

You can check the remaining capacity of the attached battery.

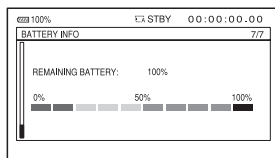

Connecting to a monitor or a TV

Playback image quality depends on the type of monitor or TV, and the jacks used to make the connection.

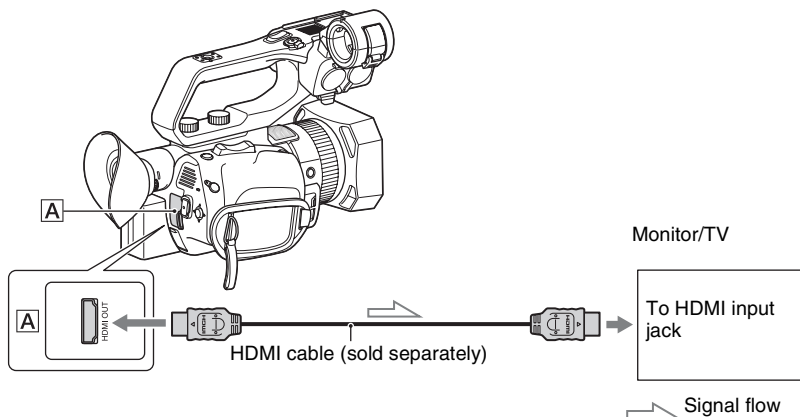

Playback

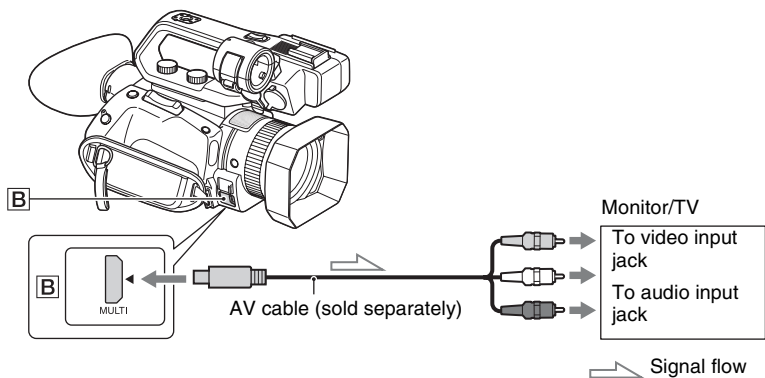

Notes

- Video signals cannot be output from the output jacks above simultaneously.
- The output resolution of VIDEO OUT is 480i when [60i] is selected, and 576i when [50i] is selected.
- It is recommended that you use an authorized cable with HDMI logo or a Sony HDMI cable.
- Images are not output from the HDMI OUT jack of your camcorder, if copyright protection signals are recorded in the movies.
- Images and sounds may not be reproduced correctly on some monitors or TVs.
- When the frame rate in [REC FORMAT] is set to 24p or 30p (when [60i] is selected) or 25p (when [50i] is selected), the output signal is converted to interlace or progressive through pull-down conversion.
- Do not connect the output jacks of the camcorder with the output jacks of the monitor or TV. A malfunction may be caused.

Connecting to a monitor or a TV (Continued)

- If you display the edit screen while outputting signals to a monitor or TV, the menu may not be displayed correctly.
- This camcorder is not compatible with “BRAVIA” sync.

Output signal formats

The signal format of the outputs from the HDMI OUT jack and multi/micro USB jack is shown below.

HDMI OUT output format (when [60i] is selected)

XAVC S 4K

--: Independent of set value

Menu item			
Recording format	HDMI	24p	HDMI OUT output signal format
REC/OUT SET> REC SET> REC FORMAT	REC/OUT SET> VIDEO OUT>HDMI	REC/OUT SET> VIDEO OUT>24p	
2160/24p	AUTO	–	2160/24p ^{*2} > 1080/60p > 1080/60i > 720/60p > 480/60p ^{*1}
	2160p/1080p/480i		2160/24p ^{*2}
	2160p/720p/480i		
	2160p/1080i/480i		
	1080p/480i	24p	During recording: 1080/24p ^{*3} During playback: 1080/60p
		60p	1080/60p
	720p/480i	–	720/60p
	1080i/480i		1080/60i
	480p		480/60p
	480i		480/60i

Menu item			
Recording format	HDMI	24p	HDMI OUT output signal format
REC/OUT SET> REC SET> REC FORMAT	REC/OUT SET> VIDEO OUT>HDMI	REC/OUT SET> VIDEO OUT>24p	
2160/30p	AUTO	–	2160/30p > 1080/60p > 1080/60i > 720/60p > 480/60p ^{*1}
	2160p/1080p/480i		2160/30p
	2160p/720p/480i		
	2160p/1080i/480i		
	1080p/480i		1080/60p
	720p/480i		720/60p
	1080i/480i		1080/60i
	480p		480/60p
	480i		480/60i

XAVC S HD/AVCHD

--: Independent of set value

Menu item			
Recording format	HDMI	24p	HDMI OUT output signal format
REC/OUT SET> REC SET> REC FORMAT	REC/OUT SET> VIDEO OUT>HDMI	REC/OUT SET> VIDEO OUT>24p	
1080/24p	AUTO	–	1080/60p > 1080/60i > 720/60p > 480/60p ^{*1}
	2160p/1080p/480i	24p	During recording: 1080/24p ^{*3} During playback: 1080/60p
		60p	1080/60p
	2160p/720p/480i	–	720/60p
	2160p/1080i/480i		1080/60i
	1080p/480i	24p	During recording: 1080/24p ^{*3} During playback: 1080/60p
		60p	1080/60p
	720p/480i	–	720/60p
	1080i/480i		1080/60i
	480p		480/60p
	480i		480/60i

Connecting to a monitor or a TV (Continued)

Menu item	HDMI		HDMI OUT output signal format
Recording format	24p		
REC/OUT SET> REC SET> REC FORMAT	REC/OUT SET> VIDEO OUT>HDMI	REC/OUT SET> VIDEO OUT>24p	
1080/30p	AUTO	–	1080/60p > 1080/60i > 720/60p > 480/60p ^{*1}
1080/60p			
720/60p	2160p/1080p/480i		1080/60p
1080/60i	2160p/720p/480i		720/60p
1080/60i (1440)	2160p/1080i/480i		1080/60i
1080/120p	1080p/480i		1080/60p
	720p/480i		720/60p
	1080i/480i		1080/60i
	480p		480/60p
	480i		480/60i

*1 Output in the format supported by the monitor or TV according to the priority order.

*2 In Slow & Quick Motion mode, the output is 2160/30p.

*3 In Slow & Quick Motion mode, the output is 1080/60p.

Multi/micro USB jack output format (when [60i] is selected)

Output is always 480/60i.

HDMI OUT output format (when [50i] is selected)

XAVC S 4K

--: Independent of set value

Menu item	HDMI		HDMI OUT output signal format
Recording format	24p		
REC/OUT SET> REC SET> REC FORMAT	REC/OUT SET> VIDEO OUT>HDMI		
2160/25p	AUTO		2160/25p > 1080/50p > 1080/50i > 720/50p > 576/50p*
	2160p/1080p/576i		2160/25p
	2160p/720p/576i		
	2160p/1080i/576i		
	1080p/576i		1080/50p
	720p/576i		720/50p
	1080i/576i		1080/50i
	576p		576/50p
	576i		576/50i

* Output in the format supported by the monitor or TV according to the priority order.

XAVC S HD/AVCHD

--: Independent of set value

Menu item		
Recording format	HDMI	HDMI OUT output signal format
REC/OUT SET> REC SET> REC FORMAT	REC/OUT SET> VIDEO OUT>HDMI	
All recording formats	AUTO	
	2160p/1080p/576i	1080/50p > 1080/50i > 720/50p > 576/50p*
	2160p/720p/576i	1080/50p
	2160p/1080i/576i	720/50p
	1080p/576i	1080/50i
	720p/576i	1080/50p
	1080i/576i	720/50p
	576p	1080/50i
	576i	576/50p
		576/50i

* Output in the format supported by the monitor or TV according to the priority order.

Multi/micro USB jack output format (when [50i] is selected)

Output is always 576/50i.

Output in Slow & Quick Motion mode

When [60i] is selected, the output format is the same as that shown on pages 70 and 71.

When [50i] is selected, the output format is the same as that shown on pages 72 and 73.

Output in Super Slow Motion mode

The output format is the same as in XAVC S HD/AVCHD mode on pages 71 and 73. Super Slow Motion is not supported in XAVC S 4K mode.

Using with a Smartphone

The Wi-Fi function of the camcorder enables you to operate the camcorder remotely by a smartphone.

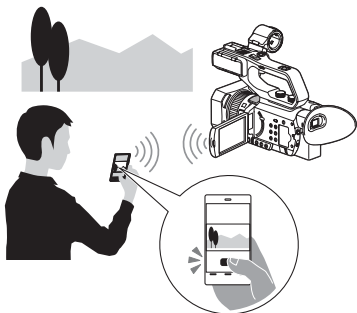

Note

The frequency band used by the wireless LAN module is part of the frequency spectrum shared by various other devices. The communication speed and communication distance may be reduced, and communication may even be interrupted, depending on the usage environment and interference with other devices.

Downloading “Content Browser Mobile”

To use a smartphone as a remote control for the camcorder, you need to install the dedicated “Content Browser Mobile” application on your smartphone. If it is already installed on your smartphone, update it to the latest version.

Android OS

Search for “Content Browser Mobile” in Google Play, then install it.



- You need Android 4.4 or later when you use the NFC One-touch.

- Google Play may not be supported depending on the country or region. In this case, search for “Content Browser Mobile” on the Internet, then install it.

iOS

Search for “Content Browser Mobile” in the App Store, then install it.



You need iOS 10 or later.

- You cannot use NFC One-touch when you use iOS.

Notes

- You need an NFC-compatible smartphone or tablet computer in order to use the NFC One-touch function of the camcorder.
- Proper operation of the Wi-Fi function detailed in this manual is not guaranteed for all smartphones or tablet computers.
- Operations and screen displays of the application may be subject to change without notice by future upgrades.

Using a smartphone as a remote controller

You can control some of the camcorder’s shooting functions remotely with a smartphone.

1 Press the MENU button.

2 Select  (NETWORK SET) → [CTRL W/SMARTPHONE].

3 Connect the smartphone to the camcorder, using the information that appears on the screen when

the camcorder is ready to be connected.

The connection method will depend on the type of smartphone.

Android device with NFC function:
page 75

Android: page 76

iPhone/iPad: page 76

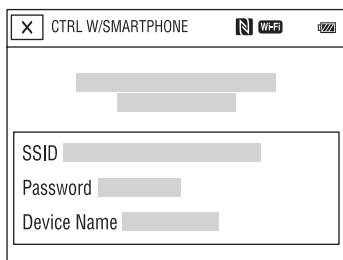

4 Operate the camcorder using “Content Browser Mobile” installed on the smartphone.

For details on how to operate “Content Browser Mobile” after it starts, refer to the Help section in “Content Browser Mobile”.

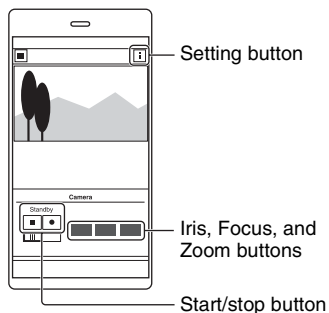

Notes

- Live view images may not be displayed smoothly, depending on the smartphone performance and/or transmission conditions.
- Movies cannot be recorded on a smartphone.
- For details about usage restrictions, see “Function limitations when recording” (p. 151).

Functions that can be controlled using [CTRL W/SMARTPHONE]

- Recording start/stop
 - Available when using manual focus.
- Touch focus
- Zoom
- Iris adjustment

Note

- You cannot perform other operations during touch focus.

Connecting the camcorder to an Android smartphone equipped with the NFC function using One-touch

1 Select [Settings] on the smartphone, then select [More...] and place a check mark next to [NFC].

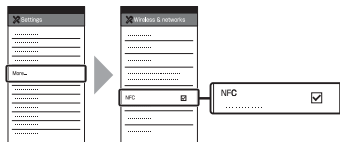

2 Set the camcorder to the shooting mode.

You can use the NFC function only when **N** (N mark) is displayed on the screen.

3 Touch the smartphone on the camcorder.

The smartphone connects to the camcorder, and “Content Browser Mobile” is activated.

[CTRL W/SMARTPHONE] starts on the camcorder.

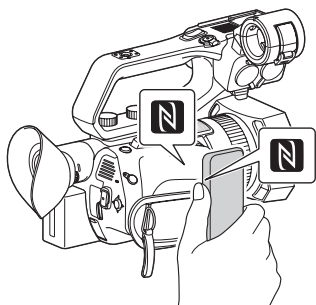

Tips

- Cancel sleep mode and screen lock of the smartphone beforehand.
- Continue to touch (1 to 2 seconds) on the camcorder without moving it, until “Content Browser Mobile” starts.
- While [CTRL W/SMARTPHONE] is activated, only the START/STOP button and handle record button are available on the camcorder.
- The smartphone cannot be connected to the camcorder when [AIRPLANE MODE] is set to [ON]. Set [AIRPLANE MODE] to [OFF] (p. 123).

Connecting without using the NFC function (Android)

- 1 Select [Settings] on your smartphone, then select [Wi-Fi] and the SSID (displayed on the camcorder).
- 2 Input the password displayed on the camcorder (first time only).
- 3 Confirm connection to the SSID displayed on the camcorder.
 **Tip**
 - The next time that you want to connect to the camcorder, select the camcorder in the device list in the Connect menu, and select [Connect].
- 4 Return to the Home screen, then start “Content Browser Mobile.”

Connecting without using the NFC function (iPhone/iPad)

- 1 Select [Settings] on the iPhone or iPad, then select [Wi-Fi] and the SSID (displayed on the camcorder).
- 2 Input the password displayed on the camcorder (first time only).

Configuring a wireless LAN

3 Confirm connection to the SSID displayed on the camcorder.

4 Return to the Home screen, then start “Content Browser Mobile.”

You can connect the camcorder to a network using a wireless LAN.

Note

- The frequency band used by the wireless LAN module is part of the frequency spectrum shared by various other devices. The communication speed and communication distance may be reduced, and communication may even be interrupted, depending on the usage environment and interference with other devices. If this occurs, try changing the channel of the access point.

Selecting and registering an access point

You can connect the camcorder and an access point using a wireless LAN.

1 Press the MENU button.

2 Select  (NETWORK SET) → [Wi-Fi SET] → [ACCESS POINT SET].

After a short delay, a list of access points that can be connected is displayed.

3 Select an access point to register.

If an access point you want to register is not displayed, select [Manual setting] and configure settings manually (p. 80).

4 Enter the password, and select [Next].

Password entry is not required for access points that do not display .

Note

- The previously entered password is not displayed for security reasons. Characters are displayed as asterisks during password entry. To switch between showing/hiding the password, press the DISPLAY button.

5 Configure the access point settings.

IP address

Select the IP address configuration method.

When [Manual] is selected, enter the IP address configuration items displayed on the screen, and select [OK].

Priority Connection

Select whether to configure connection priority for access points.

WIRELESS TC LINK

Select whether the access point uses the Wireless TC LINK function (p. 92).

Tip

- Selecting [DNS server setting] on the IP ADDRESS SET screen will display the DNS server setting screen.

6 Select [Register].

- Connection to the access point is initiated.
- [Registered.] appears when the access point is registered successfully. The SSID and frequency band of the registered access point is also displayed.

7 Select [OK].

After a short delay, a list of access points that can be connected is displayed.

The following registered icons appear on the right of the registered access points. The icon varies depending on the setting in step 5.

Priority Connection	WIRELESS TC LINK	Registered icon
On	On	
	Off	
Off	On	
	Off	

Tip

- [Priority Connection] or [WIRELESS TC LINK] can be registered on only one access point. For example, if an access point is registered with [WIRELESS TC LINK] set to [On] and a new access point is registered with [WIRELESS TC LINK] set to [On], [WIRELESS TC LINK] on the first access point is changed to [Off].

8 Select , and press the MENU button to close the menu screen.

Registering an access point using the WPS function

You can register an access point quickly if the access point supports the WPS function.

1 Turn on the access point.

2 Turn on the camcorder.

3 Press the MENU button.

4 Select (NETWORK SET) → [Wi-Fi SET] → [WPS].

After a short delay, the following screen appears.

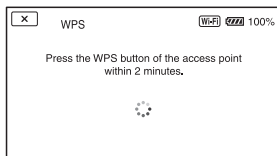

5 Press the WPS button of the access point within the next two minutes.

- For details about the WPS button function, refer to the manual for the access point.
- Connection to the access point is initiated.
- [Registered.] appears when the access point is registered successfully. The SSID and frequency band of the registered access point is also displayed.
- A message is displayed on the screen if the access point could not be connected. Select [OK], then repeat the procedure after selecting [WPS] in step 4.

6 Select [OK], and press the MENU button to close the menu screen.

Notes

- For details about the functions and settings supported by your access point, refer to the manual for the access point or contact the access point administrator.
- The camcorder and access point may not connect or the distance between them for successful communication may be short,

depending on the surrounding environment, such as obstacles and walls, and the radio wave conditions. Move the camcorder or otherwise reduce the distance between the camcorder and the access point.

Registering an access point using the WPS PIN method

You can register an access point by entering the PIN code of the access point.

1 Press the MENU button.

2 Select (NETWORK SET) → [Wi-Fi SET] → [ACCESS POINT SET].

After a short delay, a list of access points that can be connected is displayed.

3 Select [Manual setting] → [WPS PIN].

Tip

- If ten access points have been registered in the camcorder, another access point cannot be registered and a message appears. Select [Delete], and delete any access points that are no longer required.

4 Enter the PIN code displayed on the camcorder screen, within two minutes, of the access point to which to connect.

- Connection to the access point is initiated.
- [Registered.] appears when the access point is registered successfully. The SSID and frequency band of the registered access point is also displayed.

5 Select **[OK]** → **[X]**, and press the **MENU** button to close the menu screen.

Notes

- For details about the functions and settings supported by your access point, refer to the manual for the access point or contact the access point administrator.
- The camcorder and access point may not connect or the distance between them for successful communication may be short, depending on the surrounding environment, such as obstacles and walls, and the radio wave conditions. Move the camcorder or otherwise reduce the distance between the camcorder and the access point.

Registering an access point manually

1 Press the **MENU** button.

2 Select  (**NETWORK SET**) → **[Wi-Fi SET]** → **[ACCESS POINT SET]**.

After a short delay, a list of access points that can be connected is displayed.

3 Select **[Manual setting]** → **[Manual regist.]**.

Note

- If ten access points have been registered in the camcorder, another access point cannot be registered and a message appears. Select **[Delete]**, and delete any access points that are no longer required.

4 Enter the **SSID** on the displayed screen, and select **[Next]**.

5 Select the security protocol.

If **[WEP]** or **[WPS]** is displayed, enter the password on the displayed screen, and select **[Next]**.

Note

- The previously entered password is not displayed for security reasons. Characters are displayed as asterisks during password entry. To switch between showing/hiding the password, press the **DISPLAY** button.

6 Configure the access point settings.

IP address

Select the IP address configuration method.

When **[Manual]** is selected, enter the IP address configuration items displayed on the screen, and select **[OK]**.

Priority Connection

Select whether to configure connection priority for access points.

WIRELESS TC LINK

Select whether the access point uses the Wireless TC LINK function (p. 92).

Tip

- Selecting **[DNS server setting]** on the **IP ADDRESS SET** screen will display the DNS server setting screen.

7 Select **[Register]**.

- Connection to the access point is initiated.

- [Registered.] appears when the access point is registered successfully. The SSID and frequency band of the registered access point is also displayed.

8 Select [OK].

After a short delay, a list of access points that can be connected is displayed.

The following registered icons appear on the right of the registered access points. The icon varies depending on the setting in step 6.

Priority Connection	WIRELESS TC LINK	Registered icon
On	On	
	Off	
Off	On	
	Off	

Tip

- [Priority Connection] or [WIRELESS TC LINK] can be registered on only one access point. For example, if an access point is registered with [WIRELESS TC LINK] set to [On] and a new access point is registered with [WIRELESS TC LINK] set to [On], [WIRELESS TC LINK] on the first access point is changed to [Off].

9 Select [X], and press the MENU button to close the menu screen.

Changing the device name

1 Press the MENU button.

2 Select (NETWORK SET) → [WI-FI SET] → [EDIT DEVICE NAME].

“Wi-Fi Direct” and other devices appear.

To rename a device, use the following procedure to enter a name from the keyboard.

How to use the keyboard

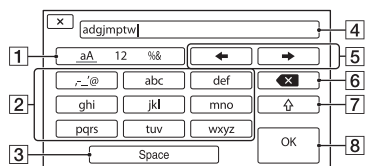

Screen items	Functions
1 Switch	Characters switch between alphabetical letters, numerals and symbols.
2 Keyboard	Characters are displayed in the order they are selected.
3 Space	Enters a space.
4 Input box	Entered characters are displayed.
5 Move cursor	Moves the cursor in the input box to the left or right
6 Delete	Deletes the character preceding the cursor
7	Switches between uppercase and lowercase alphabetical letters
8 OK	Confirms an input operation

To cancel character input midway, press .

Configuring a wired LAN

You can connect the camcorder to a network using a wired LAN.

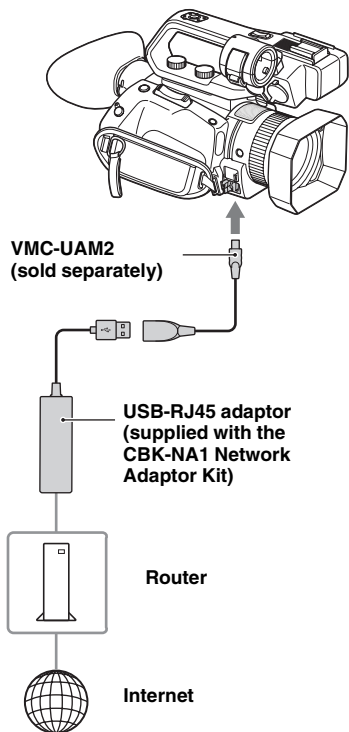

Note

- Turn the power off before attaching or removing the VMC-UAM2 and USB-RJ45 adaptor.

1 Attach the VMC-UAM2 (sold separately) to the multi/micro USB jack on the camcorder.

2 Attach a USB-RJ45 adaptor (sold separately) to the VMC-UAM2,

and then connect to the router using a LAN cable.

3 Press the MENU button.

4 Select  (NETWORK SET) → [WIRED LAN SET] → [IP ADDRESS SET].

5 Configure the access point settings.

IP address

Select the IP address configuration method.

When [Manual] is selected, enter the IP address configuration items displayed on the screen, and select [OK].

Tip

- Selecting [DNS server setting] on the IP ADDRESS SET screen will display the DNS server setting screen.

Using the streaming function (STREAMING)

You can connect the camcorder to a network and stream a movie in real-time to external devices.

Note

- Camcorder streaming uses MPEG2-TS/UDP transport stream. To view the streamed video and audio, use devices that supports this transport stream format. For details, refer to the instruction manuals of each device.

Streaming formats

There are limitations on the size of the original file movie and the streaming movie.

For details, see “Streaming, RTMP/RTMPS, and USTREAM supported formats” (p. 153).

Configuring streaming (preset registration)

You configure streaming settings and register them using PRESET beforehand to distribute a stream using those settings. The following items can be configured.

SIZE

Select the image size for streaming.

- 1280×720
- 640×360

Tip

- Select a size of “640×360” for increased streaming distribution stability.

DESTINATION SET

Configure the streaming distribution destination.

- **Host Name:** IP address or host name of the receiver
- **Port:** Port number used for streaming on the receiver

1 Configure the basic network settings (p. 77, 82).

2 Press the MENU button.

3 Select  (NETWORK SET) → [STREAMING] → desired PRESET number → configuration item.

4 Select/set the setting value.

5 Press the MENU button to return to the shooting screen.

Streaming distribution

You can distribute a stream of the movie, while shooting, using the connected network.

1 Check that the network connection settings are successful (p. 77, 82).

2 Press the MENU button.

3 Select  (NETWORK SET) → [STREAMING] → [EXECUTE] → network connection method.

- The network connection starts.

Using the streaming function (STREAMING) (Continued)

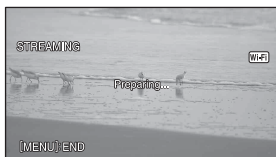

- The status of the network connection is displayed using the following icons.

Icon	Meaning
	Before wireless LAN connection and after disconnection
	Wireless LAN connected
	Wired LAN connection

- To cancel streaming, press the MENU button or press the ASSIGN button assigned with the [STREAMING] function, or select .
- When connection is successful, appears on the screen and the camcorder is ready to start streaming.

4 Press the THUMBNAIL button to start streaming distribution.

- The screen icon changes to .

5 Press the THUMBNAIL button again to stop streaming distribution.

Notes

- The streaming function is not available when using the following functions.
 - In the following formats when the file format is XAVC S 4K:
2160/30p 100Mbps, 2160/24p 100Mbps, 2160/25p 100Mbps
 - In the following formats when the file format is XAVC S HD:
1080/120p 100Mbps, 1080/100p 100Mbps

- In the following formats when the file format is AVCHD:
1080/60p, 1080/50p, 720/60p, 720/50p
 - During movie recording/playback
 - During thumbnail display
 - SLOW & QUICK (S&Q MOTION, SUPER SLOW MOTION)
 - When executing other network functions
- The following functions are not available when the streaming function is on.

Unavailable functions during streaming

- Menu operations
 - Touch operation of the LCD screen
 - SIMUL/RELAY REC
 - PROXY REC MODE
 - DATE REC
 - ZEBRA
 - PEAKING
 - MARKER
 - HISTOGRAM
 - LOCK-ON AF
 - FACE DETECTION
 - COLOR BAR
 - D. EXTENDER
 - SLOW & QUICK (S&Q MOTION, SUPER SLOW MOTION)
 - NIGHTSHOT
 - FOCUS MAGNIFIER
 - AUTO MODE SET
 - WB SET (during streaming)
 - Other network functions
 - STATUS CHECK
- Only wired LAN connection is supported when [AIRPLANE MODE] is set to [ON].
 - During streaming, the camcorder does not turn off even if the LCD screen is closed and the viewfinder is returned to its original position.
 - [4K REC OUTPUT] is fixed to [VF/LCD PANEL].
 - [LCD BRIGHT] is fixed to [NORMAL].
 - Streaming transmits the raw video and audio data via the Internet. Accordingly, the data may be disclosed to other parties.
 - Check that the streaming data is being received by the receiving device.
 - Data may be transmitted to a third party if the address or other settings are configured incorrectly.

- Some frames may not be played, depending on the network status.
- The image quality of fast-changing scenes may be adversely affected.
- White balance

Tip

- If an error occurs during streaming distribution standby or during streaming distribution, a message appears. If [RECONNECT] appears, selecting it will attempt to reconnect the camcorder. Selecting [END] will disconnect the camcorder. Repeat the procedure from step 1 to reconnect.

To record using the camera while streaming

You can record movies in XAVC S or AVCHD on a memory card while streaming is in progress.

Press the START/STOP button (handle record button) after the camcorder enters streaming standby mode to start recording. To stop recording, press the START/STOP button (handle record button) again.

The camcorder recording status is displayed using the following indicators.

STBY: Standby mode

REC: Recording

Note

- During streaming, switching the current slot using the SLOT SELECT button or removing/inserting media is not possible.

Camcorder operation during streaming

The following functions are enabled during streaming. Use the hardware switches and buttons to control the camcorder. Operation from the menu is not supported.

- Zoom
- Focusing
- To adjust the output audio level, adjust the input level using the AUDIO LEVEL dial of the XLR handle unit.
- Exposure adjustment (iris, ISO sensitivity/gain, and shutter speed)

Streaming movies using RTMP/RTMPS

You can connect the camcorder to a network and stream a movie in real-time using the RTMP/RTMPS protocol.

Note

- To view RTMP/RTMPS streamed video and audio, use devices that support this transport stream format. For details, refer to the instruction manuals of each device.

Configuring RTMP/RTMPS streaming (preset registration)

You configure RTMP/RTMPS streaming settings and register them using PRESET beforehand to distribute a stream using those settings.

The following items can be configured.

DISPLAY NAME

Set the PRESET name.

SIZE

Select the image size for RTMP/RTMPS streaming.

– 1280×720

– 640×360

Tip

- Select a size of “640×360” for increased RTMP/RTMPS streaming distribution stability.

DESTINATION SET

Configure the RTMP/RTMPS streaming distribution destination.

– **URL:** URL of the upload destination server

– **Stream Name:** Stream name of the program to be streamed

Note

- The previously entered stream name is not displayed for security reasons. Characters are displayed as asterisks during stream name entry. To switch between showing/hiding the stream name during keyboard entry, press the DISPLAY button.

1 Configure the basic network settings (p. 77, 82).

2 Press the MENU button.

3 Select  (NETWORK SET) → [RTMP/RTMPS] → desired PRESET number → configuration item.

4 Select/set the setting value.

5 Press the MENU button to return to the shooting screen.

RTMP/RTMPS streaming distribution

You can distribute an RTMP/RTMPS stream of the movie, while shooting, using the connected network.

1 Check that the network connection settings are successful (p. 77, 82).

2 Press the MENU button.

3 Select  (NETWORK SET) → [RTMP/RTMPS] → [EXECUTE] → network connection method.

- The network connection starts.



- The status of the network connection is displayed using the following icons.

Icon	Meaning
	Before wireless LAN connection and after disconnection
	Wireless LAN connection
	Wired LAN connection

- To cancel RTMP/RTMPS streaming, press the MENU button or press the ASSIGN button assigned with the [RTMP/RTMPS] function, or select [X].
- When connection is successful, appears on the screen and the camcorder is ready to start streaming.

4 Press the THUMBNAIL button to start RTMP/RTMPS streaming.

- The screen icon changes to .

5 Press the THUMBNAIL button again to stop RTMP/RTMPS streaming.

Notes

- The RTMP/RTMPS function is not available when using the following functions.
 - When the file format is XAVC S 4K
 - In the following formats when the file format is XAVC S HD:
 - 1080/120p 100 Mbps, 1080/100p 100 Mbps

- In the following formats when the file format is AVCHD:
 - 1080/60p, 1080/50p, 720/60p, 720/50p
- During movie recording/playback
- During thumbnail display
- SLOW & QUICK (S&Q MOTION, SUPER SLOW MOTION)
 - When executing other network functions
- The following functions are not available when the RTMP/RTMPS function is on.
 - Functions listed in “Unavailable functions during streaming” (p. 84) in “Using the streaming function (STREAMING)”
- Only wired LAN connection is supported when [AIRPLANE MODE] is set to [ON].
- During RTMP/RTMPS streaming, the camcorder does not turn off even if the LCD screen is closed and the viewfinder is returned to its original position.
- [LCD BRIGHT] is fixed to [NORMAL].
- RTMP/RTMPS streaming transmits the raw video and audio data via the Internet. Accordingly, the data may be disclosed to other parties.
- Check that the RTMP/RTMPS streaming data is being received by the receiving device.
- Data may be transmitted to a third party if the address or other settings are configured incorrectly.
- Some frames may not be played, depending on the network status.

Tip

- If an error occurs during RTMP/RTMPS streaming standby or during RTMP/RTMPS streaming, a message appears. If [RECONNECT] appears, selecting it will attempt to reconnect the camcorder. Selecting [END] will disconnect the camcorder. Repeat the procedure from step 1 to reconnect.

To record using the camera while RTMP/RTMPS streaming

Press the START/STOP button (handle record button) to start recording. To stop recording, press the START/STOP button (handle record button) again.

The camcorder recording status is displayed using the following indicators.

Streaming movies using RTMP/RTMPS (Continued)

STBY: Standby mode

REC: Recording

Note

- During streaming, switching the current slot using the SLOT SELECT button or removing/inserting media is not possible.

Camcorder operation during RTMP/RTMPS streaming

The following functions are enabled during RTMP/RTMPS streaming. Use the hardware switches and buttons to control the camcorder. Operation from the menu is not supported.

- Zoom
- Focusing
- To adjust the output audio level, adjust the input level using the AUDIO LEVEL dial of the XLR handle unit.
- Exposure adjustment (iris, ISO sensitivity/gain, and shutter speed)
- White balance

Stopping RTMP/RTMPS

1 Stop streaming.

2 Press one of the following.

- MENU button
 - ASSIGN button assigned with the RTMP/RTMPS start/stop function
- RTMP/RTMPS stops.

Importing an RTMPS certificate

An RTMPS certificate is required to connect using RTMPS. The camcorder contains a built-in RTMPS certificate, which can also be updated.

To update the RTMPS certificate, save the certificate on a memory card and then import the certificate from the memory card.

1 Write the RTMPS certificate to a memory card.

Write the certificate in PEM format with a “RTMPS_certification.pem” file name to the root directory of the memory card.

2 Insert the memory card with the RTMPS certificate into memory card slot A of the camcorder.

3 Press the MENU button.

4 Select (NETWORK SET) → [RTMP/RTMPS] → [RTMPS CERTIFICATE] → [OK].

- The RTMPS certificate starts importing.
- The certificate is imported successfully when “Completed.” appears. Select [OK] to dismiss the screen.

Notes

- Do not eject the memory card while a certificate is being imported.

- Resetting network settings (p. 95) will delete the RTMPS certificate imported from the memory card, and will initialize the RTMPS certificate of the camcorder.

Streaming movies using USTREAM

You can distribute movies using the USTREAM video sharing site. USTREAM user registration is required beforehand.

There are limitations imposed by USTREAM for video distribution using USTREAM. For details, visit the USTREAM site.

Configuring USTREAM authentication

- 1 Configure the basic network settings (p. 77, 82).**
- 2 Select  (NETWORK SET) → [USTREAM] → [USER INFO SET].**
- 3 Select the connection method (wired/wireless).**
- 4 Enter the following information, and select OK.**
 - User: User name
 - Password: Password

“Completed.” is displayed if authentication is successful.

Notes

- The previously entered password is not displayed for security reasons. Characters are displayed as asterisks during password entry. To switch between showing/hiding the password during keyboard entry, press the DISPLAY button.
- From a security standpoint, it is recommended that you set a password with a sufficiently long character string that is hard to guess by others, and that you store it safely.

Streaming movies using USTREAM (Continued)

💡 Tip

- A confirmation message appears if you have already configured authentication. You can switch the account used for streaming, if required.

Configuring using the menu

Configure the following items in **[NETWORK SET]** → **[USTREAM]**.

SIZE

Select the image size for USTREAM distribution.

- 640×360 (default setting)
- 1280×720

💡 Tip

- The frame rate of the streaming data will vary depending on the recording settings for the original file (p. 153).

SERVER REC SET

Set whether to record the distributed movie on the USTREAM server.

- ON: Record (default setting)
- OFF: Do not record

Starting USTREAM



1 Select **[NETWORK SET]** → **[USTREAM]** → **[EXECUTE]**.

Configure authentication in **[USER INFO SET]** if you haven't already done so.

2 Select the connection method (**wired/wireless**).

The network connection starts.

The status of the connection is displayed using the following icons.

Icon	Meaning
	Before wireless LAN connection and after disconnection
	Wireless LAN connected
	Wired LAN connection

3 Select a channel.

USTREAM distribution is enabled.

 appears on the screen and the camcorder is ready to start streaming.

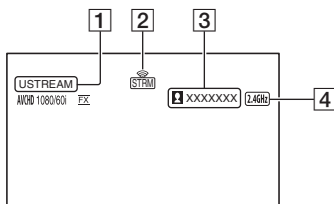

4 Press the **THUMBNAIL** button to start streaming.

- The screen icon changes to .



1 USTREAM

2 Streaming status indicator

Icon	Meaning
	Streaming standby
	Streaming

3 Number of viewers
">1000000" is displayed if the number of viewers exceeds 1,000,000.

4 Wi-Fi or LAN

5 To stop streaming, press the THUMBNAIL button again.

Notes

- Check that the date and time have been set correctly on the camcorder before starting streaming.
- When a channel is selected, text characters not supported on the camcorder may not be displayed correctly.
- The USTREAM function is not available when using the camcorder in the following states.
 - When the file format is XAVC S 4K
 - In the following formats when the file format is XAVC S HD:
1080/120p 100Mbps, 1080/100p 100Mbps
 - In the following formats when the file format is AVCHD:
1080/60p, 1080/50p, 720/60p, 720/50p
 - During movie recording/playback
 - During thumbnail display
 - SLOW & QUICK (S&Q MOTION, SUPER SLOW MOTION)
 - When executing other network functions
- The following functions are not available when the USTREAM function is on.
 - Functions listed in “Unavailable functions during streaming” (p. 84) in “Using the streaming function (STREAMING)”.
- Only wired LAN connection is supported when [AIRPLANE MODE] is set to [ON].
- During USTREAM streaming, the camcorder does not turn off even if the LCD screen is closed and the viewfinder is returned to its original position.
- [LCD BRIGHT] is fixed to [NORMAL].

Tip

- If the channel name is not displayed correctly, select the appropriate language in  (OTHERS) → [LANGUAGE].

To record using the camera while streaming using USTREAM

Press the START/STOP button (handle record button) to start recording.

To stop recording, press the START/STOP button (handle record button) again.

The camcorder recording status is displayed using the following indicators.

STBY: Standby mode
REC: Recording

Note

- During streaming, switching the current slot using the SLOT SELECT button or removing/inserting media is not possible.

Camcorder operation when using USTREAM

The following functions are enabled when using USTREAM. Use the hardware switches and buttons to control the camcorder. Operation from the menu is not supported.

- Zoom
- Focusing
- Streaming volume adjustment (only the AUDIO LEVEL dial of the XLR handle unit is enabled)
- Exposure adjustment (iris, ISO sensitivity/gain, and shutter speed)
- White balance

Stopping USTREAM

1 Stop streaming.

2 Press one of the following.

- MENU button
 - ASSIGN button assigned with the USTREAM start/stop function
- USTREAM stops.
-

Synchronizing the timecode of multiple cameras using a smartphone

When shooting using multiple cameras, you can synchronize the timecode of each camera using a smartphone and the Wireless TC LINK function.

To use Wireless TC LINK

The “CBKZ-WTCL” (sold separately) is required to use the Wireless TC LINK function.

After purchasing the option, connect the camcorder to a computer using USB to use the auto detect function, and install by following the instructions on the PC.

Note

- A smartphone that supports the tethering function is required to use Wireless TC LINK. To determine whether tethering is enabled on your smartphone, check with your contracted carrier.

Preparation on the smartphone

The following preparation is required on the smartphone used for timecode synchronization.

1 Install “Content Browser Mobile” on the smartphone.

For the installation procedure, see page 74.

2 Set the smartphone to tethering mode.

For details about configuring tethering, refer to the instruction manual for your smartphone.

3 Launch “Content Browser Mobile” on the smartphone.



For details on how to operate “Content Browser Mobile” after it starts, refer to the Help section in “Content Browser Mobile”.

Synchronizing the timecode to another device using a smartphone

Use the following procedure on each camera whose timecode you want to synchronize.

1 Press the MENU button.

2 Align the following settings on the cameras to synchronize the timecode.

-  (OTHERS) menu → [60i/50i SEL] (page 126)
-  (REC/OUT SET) menu → [REC SET] → [REC FORMAT] (p. 111)
-  (TC/UB SET) menu → [TC FORMAT] (p. 122)

3 Configure wireless LAN settings.

For details about configuring a wireless LAN, see page 77.

4 Select (NETWORK SET) → [Wi-Fi SET] → [ACCESS POINT SET].

After a short delay, a list of access points that can be connected is displayed.

5 Select the SSID of a smartphone that has tethering mode enabled.

If the smartphone SSID is not displayed, select [Manual setting] and configure settings manually (p. 80).



6 Select [WIRELESS TC LINK] → [ON] → [OK].

7 Select [Register].

- The smartphone connection starts.
- When connection is successful, you will be able to search for cameras using “Content Browser Mobile” on the smartphone.

8 Select (NETWORK SET) → [WIRELESS TC LINK].

The network connection starts. The status of the network connection is displayed using the following icons.

Icon	Meaning
	Before wireless LAN connection and after disconnection
	Wireless LAN connected

9 Start timecode synchronization from the smartphone.

“TC has been synced.” appears on the screen when synchronization is successful.

Notes

- There may be an offset of several frames after timecode synchronization.
- The timecode advance may become non-contiguous at the instant the timecode is synchronized. If this occurs, the timecode output on HDMI OUT will also be non-contiguous.

- Timecode synchronization is not performed if a camera is currently recording, in order to maintain a contiguous timecode.
- For lengthy continuous recording, periodic timecode synchronization cannot be performed, which may lead to an offset of several frames per hour.
- When a camera is turned off, Wireless TC LINK also stops. When the camera is turned on again, Wireless TC LINK is automatically executed.

10 To exit Wireless TC LINK, press the MENU button.

Notes

- The timecode continues to advance contiguously when Wireless TC LINK is stopped. To synchronize the timecode once only at the start, stop Wireless TC LINK before use after synchronizing the timecode.
- After Wireless TC LINK is stopped, you can execute Wireless TC LINK again by performing only step 9 again in the above procedure.

Notes

- The Wireless TC LINK function is not available when using the camcorder in the following states.
 - During movie recording/playback
 - During thumbnail display
 - SLOW & QUICK (S&Q MOTION, SUPER SLOW MOTION)
 - When executing other network functions
 - AIRPLANE MODE
- The following functions are not available when Wireless TC LINK is running.
 - Menu operations
 - Touch operation of the LCD screen
 - DATE REC
 - LOCK-ON AF
 - FACE DETECTION
 - COLOR BAR
 - D. EXTENDER
 - S&Q MOTION

- SLOW & QUICK (S&Q MOTION, SUPER SLOW MOTION)
 - NIGHTSHOT
 - FOCUS MAGNIFIER
 - AUTO MODE SET
 - Other network functions
- During Wireless TC LINK execution, [TC RUN] is set to [FREE RUN]. After the function is stopped, the setting remains set to [FREE RUN].
 - During Wireless TC LINK execution, [TC MAKE] is set to [PRESET]. After the function is stopped, the setting remains set to [PRESET].

Tips

- You can check the last synchronization time with the status check function (p. 68).
- If the timecode from a smartphone is changed during Wireless TC LINK execution, “TC has been synced.” is displayed.
- After the “TC has been synced.” message appears, the timecode is adjusted on each camera.

Importing a root certificate

A root certificate is required for USTREAM streaming. The camcorder contains a built-in root certificate, which can also be updated. To update the root certificate, save the certificate on a memory card and then import the certificate from the memory card.

1 Write the root certificate to a memory card.

Write the certificate in PEM format with a “certification.pem” file name to the root directory of the memory card.

2 Insert the memory card with the root certificate into memory card slot A of the camcorder.

3 Press the MENU button.

4 Select (NETWORK SET) → [ROOT CERTIFICATE] → [OK].

- The root certificate starts importing.
- The certificate is imported successfully when “Completed.” appears. Select [OK] to dismiss the screen.

Notes

- Do not eject the memory card while a certificate is being imported.
- Resetting network settings (p. 95) will delete the root certificate imported from the memory card, and will initialize the root certificate of the camcorder.

Note on wireless network function

We assume no responsibility whatsoever for any damage caused by unauthorized access to, or unauthorized use of,

destinations loaded on the camcorder, resulting from loss or theft.

Security in the use of wireless LAN devices

- To avoid hacking, access by malicious third parties, and other vulnerabilities, confirm that the wireless LAN is always secure.
- It is very important to set up security on a wireless LAN.
- If a problem occurs due to inadequate security measures or due to foreseeable circumstances, Sony Corporation is not responsible for any resulting damage.

Resetting network settings

The following settings are reset when resetting network settings.

- SSID/password for smartphone operation (p. 74)
- Streaming settings (p. 83)
- RTMP/RTMPS settings (p. 86)
- RTMPS certificate (p. 88)
- USTREAM settings (p. 89)
- Wired LAN settings (p. 82)
- Access point settings (p. 77 to 80)
- Device name (p. 81)
- Root certificate (p. 94)

1 Press the MENU button.

2 Select  (NETWORK SET) → [NETWORK RESET] → [OK].

The camcorder restarts.

Protecting movies (Protect)

Protect movies to avoid deleting them by mistake.

1 Press the **MENU** button when the **THUMBNAIL** screen is displayed.

2 Select  (**EDIT**) → [**PROTECT**].

3 Touch the movies to be protected.

✓ is displayed on the selected images.

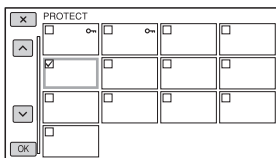

- Press and hold the thumbnail to preview the image. Press  to return to the previous screen.
- You can select up to 100 images at one time.

4 Touch , successively, according to the screen display.

To undo the protection

Touch the movie marked with ✓ in step 3. ✓ disappears.

Dividing a movie

You can divide a movie at a designated point.

1 Press the **MENU** button while playing back movies.

2 Select  (**EDIT**) → [**DIVIDE**].

3 Touch  at the point where you want to divide.

After you select the point with , make fine adjustment with these buttons.

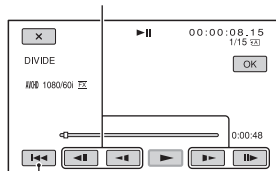

Returns to the beginning of the selected movie.

4 Touch , successively, according to the screen display.

🔍 Notes

- Dividing movies is supported for AVCHD only.
- You cannot restore movies once they are divided.
- Do not remove the battery pack, the AC Adaptor or the memory card that contains the movies from your camcorder during the operation. It may damage the memory card.
- A slight time difference may occur between the point where you touch  and the actual dividing point, as your camcorder selects the dividing point based in about half-second increments.

Deleting movies

You can free media space by deleting movies from a memory card.

Notes

- You cannot restore images once they are deleted.
- Do not remove the battery pack, the AC Adaptor, or the memory card from your camcorder during the operation. It may damage the memory card.
- You cannot delete protected movies. Undo the protection of the movies before you try to delete them (p. 96).
- Save important movies beforehand.

Tip

- To delete all data recorded on a memory card and recover all the recordable space, format the media (p. 98).

4 Touch **[OK]**, successively, according to the screen display.

1 Press the **MENU** button when the **THUMBNAIL** screen is displayed.

2 Select **[EDIT]** → **[DELETE]**.

3 Touch the movies to be deleted.

- ✓ is displayed on the selected images.

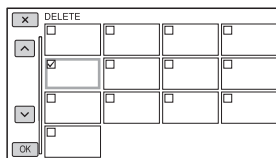

- Press and hold the thumbnail to preview the image. Press **[X]** to return to the previous screen.
- You can select up to 100 images at one time.
- **[P]** appears at the upper right corner on the thumbnail of protected images.
- No checkbox appears on the thumbnail of protected images.

Formatting a memory card

Formatting deletes data from the memory card to recover recordable free space.

🔌 Notes

- Connect your camcorder to the wall outlet (wall socket) using the supplied AC Adaptor to prevent your camcorder from running out of power during the operation.
- To avoid the loss of important images, you should save them before formatting a memory card.
- Protected movies are also deleted.

1 Press the **MENU** button.

2 Select  (OTHERS) → [MEDIA FORMAT].

3 Select the memory card to be formatted.

4 Touch , successively, according to the screen display.

🔌 Note

- While [Executing...] is displayed, do not turn off the camcorder, do not operate any buttons on the camcorder, disconnect the AC Adaptor, or remove the memory card from your camcorder. (The access lamp is lit or flashing during formatting.)

Deleting all data from the memory card completely

If a memory card is used repeatedly, garbage data accumulate which may prevent the image data from being written at the fixed speed. In this case, recording may stop suddenly.

If this happens, empty the memory card to avoid the writing error. Emptying the memory card can erase more data than ordinary formatting.

🔌 Notes

- If you perform this operation, all stored data are deleted. To avoid the loss of important images, you should save them before formatting a memory card.
- You cannot perform this operation unless you connect the AC Adaptor to the wall outlet (wall socket).
- Disconnect all cables except the AC Adaptor. Do not disconnect the AC Adaptor during the operation.
- Do not apply any vibrations or shocks to your camcorder during this operation.

1 Connect your camcorder to the wall outlet (wall socket) using the AC Adaptor (supplied) (p. 22).

2 Press the **MENU** button.

3 Select  (OTHERS) → [MEDIA FORMAT].

4 Select the memory card to delete.
The deletion screen appears.

5 Touch [Empty] → .

Repairing the image database file

Notes

- It may take from several minutes to several hours to empty a memory card, depending on the capacity. You can check the actual time required on the LCD screen.
- If you stop the operation while [Executing...] is displayed, be sure to complete the operation by performing [MEDIA FORMAT] or emptying before you use the memory card next time.

Tip

- To prevent a data write error from occurring on the recording media, empty the media data from the camcorder before you start recording. By deleting all data using the [Empty] operation instead of the ordinary [MEDIA FORMAT] operation, you can minimize potential media write errors that might occur when recording.

This function checks the database information and the consistency of movies on the memory card, and repairs any inconsistencies found.

Notes

- Connect your camcorder to the wall outlet (wall socket) using the supplied AC Adaptor to prevent your camcorder from running out of power during the operation.
- Correct repair may not be possible, even when repair is executed.

1 Press the MENU button.

2 Select  (OTHERS) → [REPAIR IMAGE DB FILE].

3 Select the memory card for which you want to check the database file.

4 Touch .

The database file check starts. Select  and quit the database file check if no inconsistency is found.

5 Touch , successively, according to the screen display.

Note

- If you stop the operation while “Repairing the image database file.” is displayed, be sure to complete the operation as described above before you use the memory card next time.

Operating the menu

You can change various settings or make detailed adjustments using the menu items displayed on the LCD screen.

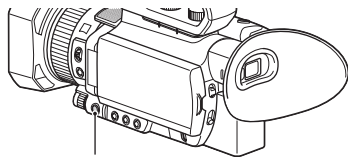

MENU button

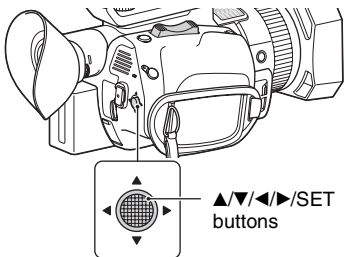

▲▼/◀▶/SET buttons









Notes

- The available menu items vary depending on the context of your camcorder during recording or playback.
- Items and setting values not available due to other settings are grayed out.

1 Press the MENU button.

The menu screen appears.

2 Use the ▲▼/◀▶/SET buttons to select the desired menu, then press the button.

-  CAMERA SET (p. 103)
-  REC/OUT SET (p. 111)
-  AUDIO SET (p. 116)
-  DISPLAY SET (p. 118)
-  TC/UB SET (p. 122)
-  NETWORK SET (p. 123)
-  OTHERS (p. 125)
-  EDIT (p. 127)

To return to the previous screen, select [↶ RETURN].

Menu items

📷 CAMERA SET

- ISO/GAIN SEL
- AUTO ISO LIMIT
- AGC LIMIT
- WB PRESET
- WB OUTDOOR LEVEL
- WB TEMP SET
- WB SET
- AE SHIFT
- D. EXTENDER
- ZOOM SET
- 📷 STEADYSHOT
- FOCUS AREA
- AF DRIVE SPEED
- AF SUBJ. TRACK SET
- LOCK-ON AF
- FACE DETECTION
- SLOW & QUICK
- AUTO MODE SET
- SCENE SELECTION SET
- SPOT METER/FOCUS
- SPOT METER
- SPOT FOCUS
- LOW LUX
- AUTO BACK LIGHT
- NIGHTSHOT
- NIGHTSHOT LIGHT
- COLOR BAR
- PICTURE PROFILE

🔄 REC/OUT SET

- REC SET
- VIDEO OUT

🎵 AUDIO SET

- VOLUME
- AVCHD AUDIO FORMAT
- AUDIO REC LEVEL
- INT MIC WIND
- MIC SELECT
- AUDIO OUTPUT TIMING

📺 DISPLAY SET

- HISTOGRAM
- ZEBRA
- PEAKING
- PHASE AF FRAMES
- PHASE DETECT. AF AREA
- MARKER
- FOCUS MAG RATIO
- CAMERA DATA DISPLAY
- AUDIO LEVEL DISPLAY
- ZOOM DISPLAY
- FOCUS DISPLAY
- SHUTTER DISPLAY
- DATA CODE
- GAMMA DISP ASSIST
- LCD BRIGHT
- VF COLOR TEMP.
- DISPLAY OUTPUT

🕒 TC/UB SET

- TC/UB DISPLAY
- TC PRESET
- UB PRESET
- TC FORMAT
- TC RUN
- TC MAKE
- UB TIME REC

Menu items (Continued)

NETWORK SET

- CTRL W/SMARTPHONE
- RTMP/RTMPS
- STREAMING
- USTREAM
- WIRELESS TC LINK
- WIRED LAN SET
- Wi-Fi SET
- AIRPLANE MODE
- ROOT CERTIFICATE
- NETWORK RESET

OTHERS

- STATUS CHECK
- CAMERA PROFILE
- S&Q BUTTON SETTING
- ASSIGN BUTTON
- CLOCK SET
- AREA SET
- SUMMERTIME
- LANGUAGE
- DATE REC
- BEEP
- REC LAMP
- REMOTE CONTROL
- 60i/50i SEL
- MEDIA FORMAT
- REPAIR IMAGE DB FILE
- USB CONNECT
- USB LUN SET
- OPERATION TIME
- OPTION
- VERSION DISPLAY
- CALIBRATION
- INITIALIZE

EDIT



- PROTECT
- DIVIDE
- DELETE

The function and setting value of each menu item are as follows.
 The default settings are marked with bold text.
 The display sequence of menu items may vary from the device.

CAMERA SET menu

CAMERA SET		
Menu item	Sub-items/Settings	Description
ISO/GAIN SEL	ISO, GAIN	Switches the ISO sensitivity/gain display. <ul style="list-style-type: none"> • ISO sensitivity and gain values are stored separately. • [ISO/GAIN SEL] can be set only when the AUTO/MANUAL switch is set to MANUAL.
AUTO ISO LIMIT	OFF , ISO200 to ISO4000	Selects the upper limit for ISO auto adjustment. <ul style="list-style-type: none"> • The configurable range varies depending on the [GAMMA] setting of the picture profile. • This function is not active while you adjust the ISO sensitivity manually. • The setting is enabled when [ISO/GAIN SEL] is set to [ISO]. • The value can be set independently of the value set by [AGC LIMIT].
AGC LIMIT	OFF , 24dB to 0dB	Selects the upper limit for the Auto Gain Control (AGC). <ul style="list-style-type: none"> • This function is not active while you adjust the gain manually. • The setting is enabled when [ISO/GAIN SEL] is set to [GAIN].
WB PRESET	OUTDOOR , INDOOR, MANU WB TEMP	Selects a preset white balance setting (p. 46).
WB OUTDOOR LEVEL	-7 to +7 (0)	Sets the offset value when the preset white balance is set to [OUTDOOR]. Shifts to blue when negative, and to red when positive.
WB TEMP SET	2300K to 15000K (6500K)	Sets the color temperature value when the preset white balance is set to [MANU WB TEMP].
WB SET	-	Adjusts white balance for the shooting environment using one-push button (p. 47).



Menu items (Continued)

CAMERA SET		
Menu item	Sub-items/Settings	Description
AE SHIFT	ON/OFF OFF, ON	Turns the AE shift function on/off.
	LEVEL -2.0EV to +2.0EV (0EV)	Adjusts the brightness. <ul style="list-style-type: none"> This function is not active while you adjust the iris, shutter speed, ISO sensitivity/gain all manually.
D. EXTENDER	OFF, ON	You can use 2× magnification when recording. <ul style="list-style-type: none"> This function is not available for XAVC S 4K.
ZOOM SET	ZOOM TYPE OPTICAL ZOOM ONLY, ON[CLEAR IMAGE ZOOM] , ON[DIGITAL ZOOM]	Selects the type of zoom used when operating the zoom lever. <p>OPTICAL ZOOM ONLY: Uses optical zoom only.</p> <p>ON[CLEAR IMAGE ZOOM]: Uses clear image zoom in addition to optical zoom. <ul style="list-style-type: none"> Clear Image Zoom maintains an image quality that is close to the original. </p> <p>ON[DIGITAL ZOOM]: Uses digital zoom in addition to optical zoom and clear image zoom. Image quality deteriorates within the range where  is displayed. <ul style="list-style-type: none"> The face detection function, focus area, and lock-on AF are disabled when using clear image zoom and digital zoom. </p>
	HANDLE ZOOM 1 to 8 (3)	Selects the zoom speed for the FIX position of the handle zoom speed switch.
	SPEED ZOOM OFF, ON	You can increase the zoom speed of the power zoom lever and the handle zoom. <ul style="list-style-type: none"> When you set this function to [ON], the operation sound of the zoom may also be recorded in the movie.
	 STEADYSHOT	STANDARD, ACTIVE, OFF

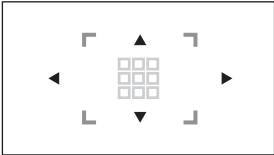
CAMERA SET

Menu item	Sub-items/Settings	Description
FOCUS AREA	WIDE	<p>Adjusts the focus automatically basically for the whole screen.</p>  <ul style="list-style-type: none">• When phase detection AF frames are displayed, you can specify the subject for focusing by touch.
	ZONE	<p>Adjusts the focus automatically within a specified zone.</p>  <ul style="list-style-type: none">• The zone is subdivided into nine squares (3 vertical x 3 horizontal).

Menu items (Continued)

CAMERA SET		
Menu item	Sub-items/Settings	Description
FOCUS AREA	CENTER	<p>Adjusts the focus automatically on the subject in the vicinity of the center of the screen.</p>  <ul style="list-style-type: none"> The auto focus operating range is indicated by the focus area frame.
	FLEXIBLE SPOT	<p>Adjusts the focus automatically at the touched position on the screen.</p>  <ul style="list-style-type: none"> This allows you to focus on small subjects or on a narrow area. The auto focus operating range is indicated by the focus area frame.
AF DRIVE SPEED	7[FAST] to 1[SLOW] (5[NORMAL])	Selects the speed for focusing used by auto focus.
AF SUBJ. TRACK SET	AF TRACKING DEPTH 5[WIDE] to 1[NARROW] (3[NORMAL])	Selects the range for tracking subjects in the depth direction.
	AF SUBJ. SWITCH. SENS. 5[RESPONSIVE] to 1[LOCKED ON] (3[NORMAL])	Selects the time taken for focusing on a new subject when switching subjects.
LOCK-ON AF	OFF, ON	Turns the focus tracking function on/off for the subject selected by touching the screen (p. 38).
FACE DETECTION	OFF, ON	Turns face detection and the facial focus function on/off (p. 39).

CAMERA SET		
Menu item	Sub-items/Settings	Description
SLOW & QUICK	S&Q MOTION	Sets Slow & Quick Motion recording.
	HIGH FRAME RATE OFF , ON	Sets slow-motion recording at high frame rate (HFR) (p. 60).
	REC FORMAT	Sets the recording format for Slow & Quick Motion.
XAVC S 4K		
	When [60i] is selected	When [50i] is selected
	2160/30p 100Mbps	2160/25p 100Mbps
	2160/30p 60Mbps	2160/25p 60Mbps
	2160/24p 100Mbps	–
	2160/24p 60Mbps	–
XAVC S HD ([HIGH FRAME RATE]: [OFF])		
	When [60i] is selected	When [50i] is selected
	1080/60p 50Mbps	1080/50p 50Mbps
	1080/30p 50Mbps	1080/25p 50Mbps
	1080/24p 50Mbps	–
XAVC S HD ([HIGH FRAME RATE]: [ON])		
	When [60i] is selected	When [50i] is selected
	1080/60p 50Mbps	1080/50p 50Mbps
	1080/30p 25Mbps	1080/25p 25Mbps
	1080/24p 25Mbps	–
AVCHD		
	When [60i] is selected	When [50i] is selected
	1080/60p PS	1080/50p PS
	1080/30p FX	1080/25p FX
	1080/24p FX	–

Menu items (Continued)

CAMERA SET																		
Menu item	Sub-items/Settings	Description																
SLOW & QUICK	FRAME RATE	Sets the frame rate for Slow & Quick Motion recording.																
		XAVC S 4K <table border="1"> <thead> <tr> <th>When [60i] is selected</th> <th>When [50i] is selected</th> </tr> </thead> <tbody> <tr> <td>30fps</td> <td>25fps</td> </tr> <tr> <td>15fps</td> <td>12fps</td> </tr> <tr> <td>8fps</td> <td>6fps</td> </tr> <tr> <td>4fps</td> <td>3fps</td> </tr> <tr> <td>2fps</td> <td>2fps</td> </tr> <tr> <td>1fps</td> <td>1fps</td> </tr> </tbody> </table>	When [60i] is selected	When [50i] is selected	30fps	25fps	15fps	12fps	8fps	6fps	4fps	3fps	2fps	2fps	1fps	1fps		
When [60i] is selected	When [50i] is selected																	
30fps	25fps																	
15fps	12fps																	
8fps	6fps																	
4fps	3fps																	
2fps	2fps																	
1fps	1fps																	
		XAVC S HD ([HIGH FRAME RATE]: [OFF]) / AVCHD <table border="1"> <thead> <tr> <th>When [60i] is selected</th> <th>When [50i] is selected</th> </tr> </thead> <tbody> <tr> <td>60fps</td> <td>50fps</td> </tr> <tr> <td>30fps</td> <td>25fps</td> </tr> <tr> <td>15fps</td> <td>12fps</td> </tr> <tr> <td>8fps</td> <td>6fps</td> </tr> <tr> <td>4fps</td> <td>3fps</td> </tr> <tr> <td>2fps</td> <td>2fps</td> </tr> <tr> <td>1fps</td> <td>1fps</td> </tr> </tbody> </table>	When [60i] is selected	When [50i] is selected	60fps	50fps	30fps	25fps	15fps	12fps	8fps	6fps	4fps	3fps	2fps	2fps	1fps	1fps
When [60i] is selected	When [50i] is selected																	
60fps	50fps																	
30fps	25fps																	
15fps	12fps																	
8fps	6fps																	
4fps	3fps																	
2fps	2fps																	
1fps	1fps																	
		XAVC S HD ([HIGH FRAME RATE]: [ON]) <table border="1"> <thead> <tr> <th>When [60i] is selected</th> <th>When [50i] is selected</th> </tr> </thead> <tbody> <tr> <td>120fps</td> <td>100fps</td> </tr> </tbody> </table>	When [60i] is selected	When [50i] is selected	120fps	100fps												
When [60i] is selected	When [50i] is selected																	
120fps	100fps																	
	SUPER SLOW MOTION	Sets Super Slow Motion recording.																

CAMERA SET																		
Menu item	Sub-items/Settings	Description																
SLOW & QUICK	REC FORMAT	Sets the recording format for Super Slow Motion. XAVC S HD <table border="1"> <thead> <tr> <th>When [60i] is selected</th> <th>When [50i] is selected</th> </tr> </thead> <tbody> <tr> <td>1080/60p 50Mbps</td> <td>1080/50p 50Mbps</td> </tr> <tr> <td>1080/30p 50Mbps</td> <td>1080/25p 50Mbps</td> </tr> <tr> <td>1080/24p 50Mbps</td> <td>–</td> </tr> </tbody> </table> AVCHD <table border="1"> <thead> <tr> <th>When [60i] is selected</th> <th>When [50i] is selected</th> </tr> </thead> <tbody> <tr> <td>1080/60p PS</td> <td>1080/50p PS</td> </tr> <tr> <td>1080/30p FX</td> <td>1080/25p FX</td> </tr> <tr> <td>1080/24p FX</td> <td>–</td> </tr> </tbody> </table>	When [60i] is selected	When [50i] is selected	1080/60p 50Mbps	1080/50p 50Mbps	1080/30p 50Mbps	1080/25p 50Mbps	1080/24p 50Mbps	–	When [60i] is selected	When [50i] is selected	1080/60p PS	1080/50p PS	1080/30p FX	1080/25p FX	1080/24p FX	–
	When [60i] is selected	When [50i] is selected																
	1080/60p 50Mbps	1080/50p 50Mbps																
	1080/30p 50Mbps	1080/25p 50Mbps																
	1080/24p 50Mbps	–																
	When [60i] is selected	When [50i] is selected																
	1080/60p PS	1080/50p PS																
	1080/30p FX	1080/25p FX																
	1080/24p FX	–																
	FRAME RATE	Sets the frame rate for Super Slow Motion recording. <table border="1"> <thead> <tr> <th>When [60i] is selected</th> <th>When [50i] is selected</th> </tr> </thead> <tbody> <tr> <td>960fps</td> <td>1000fps</td> </tr> <tr> <td>480fps</td> <td>500fps</td> </tr> <tr> <td>240fps</td> <td>250fps</td> </tr> </tbody> </table>	When [60i] is selected	When [50i] is selected	960fps	1000fps	480fps	500fps	240fps	250fps								
When [60i] is selected	When [50i] is selected																	
960fps	1000fps																	
480fps	500fps																	
240fps	250fps																	
REC TIMING START TRIGGER, END TRIGGER , END TRIGGER HALF	Selects the record timing when the record button is pressed.																	
AUTO MODE SET	AUTO , INTELLIGENT AUTO, SCENE SELECTION	Sets auto mode to optimize settings to suit the scene to record (p. 53).																
SCENE SELECTION SET	NIGHT SCENE, SUNRISE&SUNSET, FIREWORKS, LANDSCAPE, PORTRAIT , SPOTLIGHT, BEACH	Sets the scene to use when [AUTO MODE SET] is set to [SCENE SELECTION] (p. 53).																
SPOT METER/FOCUS		Automatically adjusts the brightness and focus of the subject selected by touching the screen.																
SPOT METER		Automatically adjusts the brightness of the subject selected by touching the screen.																
SPOT FOCUS		Automatically adjusts the focus of the subject selected by touching the screen.																

Menu items (Continued)

CAMERA SET		
Menu item	Sub-items/Settings	Description
LOW LUX	OFF, ON	Turns the function for shooting brighter colors in dark areas on/off. This function automatically adjusts the gain and shutter speed This function is available only when [AUTO MODE SET] is set to [AUTO].
AUTO BACK LIGHT	OFF, ON	Turns auto backlight compensation on/off.
NIGHTSHOT	ON, OFF	Turns the NIGHTSHOT function on/off.
NIGHTSHOT LIGHT	ON, OFF	Turns the infrared light source for shooting in NIGHTSHOT mode (p. 54) on/off. Infrared lighting allows you to record clearer images in dark conditions. <ul style="list-style-type: none"> • Make sure that your finger does not cover the NightShot light (p. 8) when shooting. • Remove the lens hood (supplied) so that it does not block the infrared light emitter. • The light is effective up to a distance of approximately 3 meters (10 feet).
COLOR BAR	ON/OFF OFF, ON	Displays and records color bars, and outputs audio tone signals. <ul style="list-style-type: none"> • This function is automatically set to [OFF] when you switch the format, execute a function with the MENU button, or turn off the camcorder. • The [COLOR BAR] setting cannot be changed during recording or during focus magnifier operation.
	TONE OFF, ON	Sets whether to output an audio tone signal (1 kHz: full bit, -20dB) during color bar display. When turned off, the audio from the microphone is recorded during color bar display.
PICTURE PROFILE		Displays the PICTURE PROFILE menu (p. 54).

REC/OUT SET menu

REC/OUT SET

Menu item	Sub-items/Settings	Description																
REC SET	FILE FORMAT XAVC S 4K , XAVC S HD, AVCHD	Selects the file format.																
	REC FORMAT	<p>Sets the recording format. The settings vary depending on the FILE FORMAT setting.</p> <ul style="list-style-type: none"> When [60i] is selected, the frame rate displayed on the screen differs from the actual frame rate. <table border="1"> <thead> <tr> <th>Frame rate display</th> <th>Actual frame rate</th> </tr> </thead> <tbody> <tr> <td>24</td> <td>23.98</td> </tr> <tr> <td>30</td> <td>29.97</td> </tr> <tr> <td>60</td> <td>59.94</td> </tr> <tr> <td>120</td> <td>119.88</td> </tr> </tbody> </table>	Frame rate display	Actual frame rate	24	23.98	30	29.97	60	59.94	120	119.88						
Frame rate display	Actual frame rate																	
24	23.98																	
30	29.97																	
60	59.94																	
120	119.88																	
	When FILE FORMAT is XAVC S 4K	<table border="1"> <thead> <tr> <th>When [60i] is selected</th> <th>When [50i] is selected</th> </tr> </thead> <tbody> <tr> <td>2160/30p 100Mbps</td> <td>2160/25p 100Mbps</td> </tr> <tr> <td>2160/30p 60Mbps</td> <td>2160/25p 60Mbps</td> </tr> <tr> <td>2160/24p 100Mbps</td> <td>–</td> </tr> <tr> <td>2160/24p 60Mbps</td> <td>–</td> </tr> </tbody> </table> <ul style="list-style-type: none"> Image size: 2160 (3840×2160) 	When [60i] is selected	When [50i] is selected	2160/30p 100Mbps	2160/25p 100Mbps	2160/30p 60Mbps	2160/25p 60Mbps	2160/24p 100Mbps	–	2160/24p 60Mbps	–						
When [60i] is selected	When [50i] is selected																	
2160/30p 100Mbps	2160/25p 100Mbps																	
2160/30p 60Mbps	2160/25p 60Mbps																	
2160/24p 100Mbps	–																	
2160/24p 60Mbps	–																	
	When FILE FORMAT is XAVC S HD	<table border="1"> <thead> <tr> <th>When [60i] is selected</th> <th>When [50i] is selected</th> </tr> </thead> <tbody> <tr> <td>1080/120p 100Mbps</td> <td>1080/100p 100Mbps</td> </tr> <tr> <td>1080/120p 60Mbps</td> <td>1080/100p 60Mbps</td> </tr> <tr> <td>1080/60p 50Mbps</td> <td>1080/50p 50Mbps</td> </tr> <tr> <td>1080/60p 25Mbps</td> <td>1080/50p 25Mbps</td> </tr> <tr> <td>1080/30p 50Mbps</td> <td>1080/25p 50Mbps</td> </tr> <tr> <td>1080/30p 16Mbps</td> <td>1080/25p 16Mbps</td> </tr> <tr> <td>1080/24p 50Mbps</td> <td>–</td> </tr> </tbody> </table> <ul style="list-style-type: none"> Image size: 1080 (1920×1080) 	When [60i] is selected	When [50i] is selected	1080/120p 100Mbps	1080/100p 100Mbps	1080/120p 60Mbps	1080/100p 60Mbps	1080/60p 50Mbps	1080/50p 50Mbps	1080/60p 25Mbps	1080/50p 25Mbps	1080/30p 50Mbps	1080/25p 50Mbps	1080/30p 16Mbps	1080/25p 16Mbps	1080/24p 50Mbps	–
When [60i] is selected	When [50i] is selected																	
1080/120p 100Mbps	1080/100p 100Mbps																	
1080/120p 60Mbps	1080/100p 60Mbps																	
1080/60p 50Mbps	1080/50p 50Mbps																	
1080/60p 25Mbps	1080/50p 25Mbps																	
1080/30p 50Mbps	1080/25p 50Mbps																	
1080/30p 16Mbps	1080/25p 16Mbps																	
1080/24p 50Mbps	–																	









Menu items (Continued)

REC/OUT SET																		
Menu item	Sub-items/Settings	Description																
REC SET	When FILE FORMAT is AVCHD	<table border="1"> <thead> <tr> <th>When [60i] is selected</th> <th>When [50i] is selected</th> </tr> </thead> <tbody> <tr> <td>1080/60p PS</td> <td>1080/50p PS</td> </tr> <tr> <td>1080/60i FX</td> <td>1080/50i FX</td> </tr> <tr> <td>1080/60i FH</td> <td>1080/50i FH</td> </tr> <tr> <td>1080/60i LP</td> <td>1080/50i LP</td> </tr> <tr> <td>1080/30p FX</td> <td>1080/25p FX</td> </tr> <tr> <td>1080/24p FX</td> <td>–</td> </tr> <tr> <td>720/60p HQ</td> <td>720/50p HQ</td> </tr> </tbody> </table>	When [60i] is selected	When [50i] is selected	1080/60p PS	1080/50p PS	1080/60i FX	1080/50i FX	1080/60i FH	1080/50i FH	1080/60i LP	1080/50i LP	1080/30p FX	1080/25p FX	1080/24p FX	–	720/60p HQ	720/50p HQ
		When [60i] is selected	When [50i] is selected															
		1080/60p PS	1080/50p PS															
		1080/60i FX	1080/50i FX															
		1080/60i FH	1080/50i FH															
		1080/60i LP	1080/50i LP															
		1080/30p FX	1080/25p FX															
		1080/24p FX	–															
		720/60p HQ	720/50p HQ															
		<ul style="list-style-type: none"> Image size: 1080: 1920×1080 (PS, FX, FH), 1440×1080 (LP) 720: 1280×720 (HQ) Bit-rate PS: max. 28 Mbps FX: max. 24 Mbps FH: approx. 17 Mbps (average) HQ: approx. 9 Mbps (average) LP: approx. 5 Mbps (average) 																
SIMUL/RELAY REC OFF , SIMULTANEOUS REC, RELAY REC	Sets relay recording (p. 31) or simultaneous recording (p. 32) using multiple memory cards.																	
REC BUTTON SETTING	Sets the operation of the START/STOP button and handle record button when [SIMULTANEOUS REC] is selected (p. 32).																	
PROXY REC MODE ON/OFF SIZE 1280×720 , 640×360	Sets proxy recording (p. 42).																	

REC/OUT SET		
Menu item	Sub-items/Settings	Description
VIDEO OUT	OUTPUT SELECT	Sets the video output destination.
	4K REC OUTPUT VF/LCD PANEL, EXTERNAL OUTPUT	4K REC OUTPUT: Selects whether to output the video signal when recording in 4K to the viewfinder/LCD screen or to the external output jack.
	HDMI	Selects the resolution of the output signal from the HDMI OUT jack. <ul style="list-style-type: none"> See page 70 for the format of the output signal for each type of connection cable.
	When [60i] is selected: AUTO, 2160p/1080p/480i, 2160p/720p/480i, 2160p/1080i/480i, 1080p/480i, 720p/480i, 1080i/480i, 480p, 480i	
	When [50i] is selected: AUTO, 2160p/1080p/576i, 2160p/720p/576i, 2160p/1080i/576i, 1080p/576i, 720p/576i, 1080i/576i, 576p, 576i	
	24p OUTPUT 24p/ 60p	Sets the output format when the frame rate is set to 24 and progressive scan method setting is selected. <ul style="list-style-type: none"> Available only when [60i] is selected. Enabled only when [HDMI] is set to [1080p/480i].



Menu items (Continued)

REC/OUT SET		
Menu item	Sub-items/Settings	Description
VIDEO OUT	DOWN CONVERT TYPE SQUEEZE, LETTER BOX(16:9), EDGE CROP	Sets the video output signal format. Use this function for outputting movies recorded in 16:9 under the following conditions. <ul style="list-style-type: none"> • Output from VIDEO OUT • 480p/480i output from HDMI OUT
	HDMI TC OUTPUT OFF, ON	Sets whether to output timecode to other professional-use devices, using HDMI.

REC/OUT SET									
Menu item	Sub-items/Settings	Description							
VIDEO OUT	HDMI REC CONTROL	When the camcorder is connected to an external recorder, this sets whether to record to the external recorder based on the camcorder's operation. ON: Record based on the camcorder operation. OFF: Does not record based on the camcorder operation.							
	OFF, ON	<ul style="list-style-type: none"> Icons displayed when [ON] is selected. <table border="1"> <thead> <tr> <th>Icon</th> <th>Meaning</th> </tr> </thead> <tbody> <tr> <td></td> <td>Ready to send a trigger to start recording on an external recorder.</td> </tr> <tr> <td></td> <td>A trigger to start recording has been sent to an external recorder.</td> </tr> <tr> <td>No icon</td> <td>A trigger to start recording cannot be sent to an external recorder.</td> </tr> </tbody> </table> <ul style="list-style-type: none"> VITC is not embedded when [HDMI REC CONTROL] is set to [ON]. HDMI REC CONTROL is forcibly disabled when [HDMI TC OUTPUT] is [OFF]. Even when  or  is displayed on the screen, recording to an external recorder may not be carried out correctly, depending on the external recorder's status (e.g. insufficient free space on recording media, low battery charge, incorrect connection to camcorder). When recording on an external recorder, check that recording is being carried out correctly. 	Icon	Meaning		Ready to send a trigger to start recording on an external recorder.		A trigger to start recording has been sent to an external recorder.	No icon
Icon	Meaning								
	Ready to send a trigger to start recording on an external recorder.								
	A trigger to start recording has been sent to an external recorder.								
No icon	A trigger to start recording cannot be sent to an external recorder.								

Menu items (Continued)





AUDIO SET menu

AUDIO SET		
Menu item	Sub-items/Settings	Description
VOLUME		Adjusts the volume.
AVCHD AUDIO FORMAT	LINEAR PCM, DOLBY DIGITAL	Switches the recording audio format. LINEAR PCM (): Records in linear PCM format. DOLBY DIGITAL (): Records in Dolby Digital format.
AUDIO REC LEVEL	REC LEVEL MODE NORMAL, HIGH, MANUAL MANUAL REC LEVEL 1 to 31 (21)	Sets the audio input recording level for the internal microphone and external microphone (sold separately). REC LEVEL MODE: Selects the recording level mode. MANUAL REC LEVEL: Sets the recording sensitivity when the recording level mode is [MANUAL]. <ul style="list-style-type: none">• We recommend that you wear headphones to monitor the level during adjustment.• If you repeatedly capture continuous loud sounds, setting a low level allows you to record more realistic audio.• The limiter is always enabled, regardless of the recording level setting.• The recording level cannot be adjusted when using a dedicated microphone attached to the Multi Interface Shoe.
INT MIC WIND	OFF, ON	Turns the wind noise reduction function on/off. It attenuates low tone input sound in the internal microphone to reduce wind noise.

AUDIO SET		
Menu item	Sub-items/Settings	Description
MIC SELECT	AUTO , INT MIC, MI SHOE MIC, STEREO MINI MIC	<p>Selects the microphone to use for recording audio.</p> <p>AUTO: The microphone used for recording audio is automatically selected based on the microphone that is connected.</p> <ul style="list-style-type: none"> The microphone is selected in the following order of priority: External microphone connected to MIC jack (PLUG IN POWER) > Microphone connected to XLR handle unit or Multi Interface Shoe compatible microphone > Internal microphone <p>INT MIC: Records audio using the camcorder's internal microphone.</p> <p>MI SHOE MIC: Records audio using a microphone connected to the XLR handle unit or a Multi Interface Shoe compatible microphone.</p> <p>STEREO MINI MIC: Records audio using a microphone connected to the stereo mini jack.</p> <ul style="list-style-type: none"> When [AUTO] is selected and the XLR handle unit is connected to the camcorder without a microphone attached to the INPUT1 and INPUT2 jacks, the internal microphone is not selected and no audio is recorded. In this case, select [INT MIC].
AUDIO OUTPUT TIMING	LIVE , LIP SYNC	<p>Selects the timing of the audio output when recording.</p> <p>LIVE: When recording, audio is output without any delay.</p> <p>LIP SYNC: When recording, audio is synchronized with video before output.</p> <ul style="list-style-type: none"> Select [LIP SYNC] when using the HDMI jack to record to an external device.

Menu items (Continued)

DISPLAY SET menu		
DISPLAY SET		
Menu item	Sub-items/Settings	Description
HISTOGRAM	OFF , ON, ON[ZEBRA POINT]	Sets the histogram display. OFF: Does not display a histogram. ON: Displays a histogram. A line appears at the 100% position, and the color of the zone above the line changes. ON[ZEBRA POINT]: The histogram shows the point where the zebra pattern appears. A line is displayed at the brightness level set with [ZEBRA].
ZEBRA	ZEBRA SELECT OFF , ZEBRA1, ZEBRA2	Selects the type of zebra display (ZEBRA1 or ZEBRA2). OFF: Does not display the zebra pattern. ZEBRA1: Displays a zebra pattern in areas where the image level is in the range set by [ZEBRA1 APERTURE LEVEL] centered on the image level set in [ZEBRA1 LEVEL]. ZEBRA2: Displays a zebra pattern in areas where the image level exceeds the level set in [ZEBRA2 LEVEL].
	ZEBRA1 LEVEL 0% to 109% (1) (70%)	Sets the level to display ZEBRA1.
	ZEBRA1 APERTURE LEVEL 2% to 20% (2) (10%)	Sets the range for displaying a zebra pattern centered on the level set in [ZEBRA1 LEVEL].
	ZEBRA2 LEVEL 0% to 109% (1) (100%)	Sets the level to display ZEBRA2.
PEAKING	ON/OFF OFF , ON	Sets the peaking display. • You can focus more easily using this function in combination with the focus magnifier function (p. 38). • The peaking is not recorded with the image.
	COLOR WHITE , RED, YELLOW	Selects the peaking color.
	LEVEL HIGH, MIDDLE , LOW	Selects the peaking sensitivity.
PHASE AF FRAMES	OFF , ON	Selects whether to display phase detection AF frames when shooting with auto focus and [FOCUS AREA] is set to [WIDE] or [ZONE].
PHASE DETECT. AF AREA	OFF, ON	Selects whether to display phase detection AF area when shooting with auto focus.

DISPLAY SET		
Menu item	Sub-items/Settings	Description
MARKER	ON/OFF OFF , ON	Sets the marker display. You can display multiple types of markers at the same time. <ul style="list-style-type: none"> • Markers are not recorded with the image. • During marker display, only the timecode, zebra, peaking, and face detection indicators are output, even if [DISPLAY OUTPUT] is set to [ALL OUTPUT]. • You cannot display markers when using [FOCUS MAGNIFIER].
	CENTER ON , OFF	 (Center marker)
	ASPECT OFF , 4:3, 13:9, 14:9, 15:9, 1.66:1, 1.85:1, 2.35:1	 (Aspect marker)
	SAFETY ZONE OFF , 80%, 90%	 (Safety zone)
	GUIDEFAME OFF , ON	 (Guideframe)
FOCUS MAG RATIO	×4.0, ×8.0, ×4.0/×8.0	Sets the focus magnification ratio. When “×4.0/×8.0” is selected, the setting changes in the order [×4.0] → [×8.0] → [OFF] with each press of the ASSIGN4/ FOCUS MAGNIFIER button.

Menu items (Continued)

DISPLAY SET		
Menu item	Sub-items/Settings	Description
CAMERA DATA DISPLAY	OFF, ON	Sets whether to display the iris, ISO sensitivity/gain, and shutter speed values.
<p>The screenshot shows a camera's information display. At the top left, it says '100%' and 'AVOD 1080/60i'. At the top right, it says 'STBY' and '00:04:50.04' with a battery icon. In the center, there are three data points: 'F2.8', '100', and '0dB'. Below the screenshot, lines connect these values to labels: 'Iris value' points to 'F2.8', 'ISO sensitivity/gain value' points to '100', and 'Shutter speed value' points to '0dB'.</p>		
		<ul style="list-style-type: none"> The settings appear during manual adjustment, regardless of the setting of this function. A indicates that the settings are automatically adjusted values. The indicator changes to B when exposure is fixed by [SPOT METER] or [SPOT METER/ FOCUS] (p. 45). The displayed settings are different from those displayed by [DATA CODE] (p. 67).
AUDIO LEVEL DISPLAY	ON, OFF	Sets whether to display the audio level meters.
ZOOM DISPLAY	BAR, NUMBER	Sets whether to display the zoom position as a bar or number.
FOCUS DISPLAY	METER, FEET	Sets the display of the focus distance in meters or feet.
SHUTTER DISPLAY	SECOND, DEGREE	<p>Sets the display of the shutter speed in seconds or degrees.</p> <p>The shutter speed equal to the period that your camcorder reads image data from the image sensor is defined as 360 degrees. The degree is calculated based on this definition and displayed.</p> <ul style="list-style-type: none"> When you press the ASSIGN button to which [DATA CODE] is assigned, the shutter speed is displayed in seconds regardless of this setting. If the shutter speed is more than 360 degrees, it is displayed as an integral multiple of 360 degrees (360 × 2, etc.).

DISPLAY SET		
Menu item	Sub-items/Settings	Description
DATA CODE	OFF , DATE/TIME, CAMERA DATA	Selects the information that is displayed during playback. OFF: No information is displayed. DATE/TIME: The date and time are displayed. CAMERA DATA: Camera data is displayed.
GAMMA DISP ASSIST	ON/OFF ON , OFF TYPE AUTO , S-LOG2 → 709(800%), S-LOG3 → 709(800%), HLG(BT.2020), HLG(709)	Sets whether to convert the image displayed on the viewfinder or LCD screen to close to normal video when shooting using a picture profile with S-Log or HLG (p. 57). ON/OFF: Turns the gamma display assist function on/off. TYPE: Sets the type of conversion. <ul style="list-style-type: none"> • Movies shot using S-Log2 or S-Log3, which require editing in post production, have images shot with low contrast that make live monitoring difficult. Movies shot using HLG/HLG1/HLG2/HLG3 also have low contrast when displayed on the viewfinder or LCD screen, which do not support HDR, and movies shot using BT.2020 color mode have washed out colors. To counter this, you can use [GAMMA DISP ASSIST] to obtain the contrast and color reproducibility that is close to normal video for display on the viewfinder and LCD screen to make monitoring easier. <ul style="list-style-type: none"> • This function affects only the monitoring video or playback video displayed in the viewfinder or on the LCD screen. The recorded video and output video are not affected.
LCD BRIGHT	NORMAL , BRIGHT	Adjusts the brightness of the LCD screen. <ul style="list-style-type: none"> • Changes in the LCD brightness do not affect the brightness of recorded images.
VF COLOR TEMP.	-2/-1/0/+1/+2 (0)	Sets the color temperature of the viewfinder. Low color temperature makes the viewfinder appear reddish, and high color temperature makes it appear bluish.

Menu items (Continued)

DISPLAY SET		
Menu item	Sub-items/Settings	Description
DISPLAY OUTPUT	LCD PANEL, ALL OUTPUT	<p>Sets the output to display information, such as the timecode.</p> <p>You can select to display information on the LCD screen only, or output the information to the VIDEO OUT, HDMI OUT jacks and the LCD screen. Zebra, peaking and the frame on the face are also output.</p> <ul style="list-style-type: none">• During marker display, only the timecode, zebra, peaking, and face detection indicators are output, even if [DISPLAY OUTPUT] is set to [ALL OUTPUT].

TC/UB SET menu

TC/UB SET		
Menu item	Sub-items/Settings	Description
TC/UB DISPLAY	TC, U-BIT	Switches the display to timecode or user bits.
TC PRESET	PRESET, RESET	Sets the timecode (p. 58).
UB PRESET	PRESET, RESET	Sets the user bits (p. 59).
TC FORMAT	DF, NDF	<p>Switches the timecode recording method when [60i] is selected. The timecode is fixed to [NDF] when [50i] is selected.</p> <p>DF: Records the timecode in drop frame. NDF: Records the timecode in non-drop frame.</p> <ul style="list-style-type: none">• The timecode is also fixed to [NDF] (when [60i] is selected) when the frame rate is set to 24 in [REC FORMAT].• Drop-frame Timecode is based on 30 frames per second; however, gaps in the actual time occur during extended periods of recording as the actual frame frequency of NTSC image signals is 29.97 frames per second. Drop frame corrects this gap to make timecode and actual time equal. In drop frame, the first 2 frame numbers are removed every minute except in every tenth minute. Timecode without this correction is called non-drop frame.

TC/UB SET		
Menu item	Sub-items/Settings	Description
TC RUN	REC RUN, FREE RUN	<p>Sets how the timecode advances.</p> <p>REC RUN: Advances the timecode only during recording. Select this setting to record the timecode sequentially from the last timecode of the previous recording.</p> <ul style="list-style-type: none"> • Even if the timecode advances in [REC RUN] mode, the timecode may not be recorded sequentially in the following cases: <ul style="list-style-type: none"> – When the recording format is changed. – When the memory card is removed. <p>FREE RUN: Advances the timecode regardless of operation of your camcorder.</p>
TC MAKE	PRESET, REGENERATE	<p>Sets how the timecode continues.</p> <p>PRESET: Records a preset set timecode on the memory card.</p> <p>REGENERATE: Reads the last recorded timecode from the memory card, and starts recording with a consecutive timecode.</p> <ul style="list-style-type: none"> • The timecode advances in [REC RUN] mode, regardless of the setting of [TC RUN].
UB TIME REC	OFF, ON	<p>Sets whether to save the actual time in user bit code.</p> <ul style="list-style-type: none"> • The last 2 digits are fixed to “00” when it is set to [ON].

NETWORK SET menu

NETWORK SET		
Menu item	Sub-items/Settings	Description
CTRL W/ SMARTPHONE		Enables operation with a smartphone (p. 74).
RTMP/RTMPS	PRESET SELECT PRESET1, PRESET2, PRESET3 <hr/> PRESET1/PRESET2/ PRESET3 DISPLAY NAME SIZE 640×360, 1280×720 DESTINATION SET <hr/> RTMPS CERTIFICATE	Configures RTMP/RTMPS settings (p. 86)

Menu items (Continued)

NETWORK SET		
Menu item	Sub-items/Settings	Description
STREAMING	PRESET SELECT PRESET1 , PRESET2, PRESET3	Sets streaming (p. 83).
	PRESET1/PRESET2/ PRESET3 SIZE 640×360 , 1280×720 DESTINATION SET	
USTREAM	USER INFO SET SIZE 640×360 , 1280×720	Configures USTREAM settings (p. 89).
	SERVER REC SET ON , OFF	Set whether to record the distributed movie on the USTREAM server.
WIRELESS TC LINK		Synchronizes timecodes using a smartphone if “CBKZ-WTCL” is installed on the camcorders (p. 92).
WIRED LAN SET	IP ADDRESS SET	Configures a wired LAN (p. 82).
Wi-Fi SET	ACCESS POINT SET	<ul style="list-style-type: none"> • Selects and configures an access point (p. 77). • Registers an access point using the WPS PIN method (p. 79). • Registers an access point manually (p. 80).
	WPS	Registers an access point using the WPS function (p. 78).
	EDIT DEVICE NAME	Edits the device name (p. 81).
	SSID/PW RESET	Resets the connection information. When [OK] is selected, the connection information registered in order to use [CTRL W/SMARTPHONE] is reset. <ul style="list-style-type: none"> • If the connection information has been reset, it will be necessary to set up the smartphone again, in order to connect it to the camcorder.
	DISP MAC ADDRESS	Displays the camcorder’s MAC address.
AIRPLANE MODE	OFF , ON	Turns airplane mode on/off. When turned on, all Wi-Fi-related settings are temporarily disabled (for when boarding a plane, etc.).
ROOT CERTIFICATE		Imports a root certificate (p. 94).
NETWORK RESET		Resets network settings (p. 95).

OTHERS menu

OTHERS

Menu item	Sub-items/Settings	Description
STATUS CHECK		Checks the settings in your camcorder (p. 68).
CAMERA PROFILE	MEMORY CARD A, MEMORY CARD B	<p>Loads, saves, and deletes camera profiles.</p> <ul style="list-style-type: none"> • A camera profile saves configuration settings, such as menu, picture profile, and button settings. Up to 99 profiles can be saved on a memory card. • Camera profiles for the 50i model and 60i model are not compatible. • You cannot use a computer to edit saved settings. • The file may not be shown properly if the file name is changed on the computer, or the power turned off during generation. • A camera profile saved on a camcorder with different model name, or edited on a computer cannot be loaded. <p>Formatting the memory card also deletes saved camera profiles.</p>
S&Q BUTTON SETTING	S&Q/SUPER SLOW, S&Q MOTION, SUPER SLOW MOTION	<p>Sets the function of the button to which S&Q MOTION is assigned.</p> <p>S&Q/SUPER SLOW: Each time the button is pressed, the function switches between Slow & Quick Motion mode → Super Slow Motion mode → Off.</p> <p>S&Q MOTION: Sets Slow & Quick Motion mode.</p> <p>SUPER SLOW MOTION: Sets Super Slow Motion mode.</p>
ASSIGN BUTTON	ASSIGN1, ASSIGN2, ASSIGN3, ASSIGN4, ASSIGN5, ASSIGN6	Assigns functions to the ASSIGN buttons (p. 64).
CLOCK SET		Sets the date and time (p. 24).
AREA SET		<p>Sets the time difference for when using the camcorder abroad.</p> <p>You can adjust the time difference without stopping the clock.</p>
SUMMERTIME	OFF, ON	Sets whether to use summer time. When set to [ON], the time moves forward 1 hour.
LANGUAGE		Sets the display language.

Menu items (Continued)

OTHERS		
Menu item	Sub-items/Settings	Description
DATE REC	OFF, ON	Sets whether to record the date and time on the recorded images. <ul style="list-style-type: none"> You can set this item only when the interlace scanning system is selected. When zebra or peaking is activated, the date and time characters are affected by the signal, but are properly recorded on images.
BEEP	OFF, ON	Sets whether to emit a sound when you start/stop recording or when a warning appears, etc.
REC LAMP	ON, OFF	Sets whether to turn on the recording lamp of the camcorder when recording.
REMOTE CONTROL	ON, OFF	Sets whether to use the infrared Wireless Remote Commander (p. 16).
60i/50i SEL		Selects the frame rate corresponding to the television format of the region where the camcorder is used. 60i: NTSC 50i: PAL The default setting is 60i for NTSC regions and 50i for PAL regions. Refer to the label on the bottom of the camcorder. The camcorder automatically restarts if you change the setting.
MEDIA FORMAT	MEMORY CARD A, MEMORY CARD B	Formats a memory card (p. 98).
REPAIR IMAGE DB FILE	MEMORY CARD A, MEMORY CARD B	Repairs the image database file of a memory card (p. 99).
USB CONNECT		Use this if [USB CONNECT] does not appear after connecting the camcorder to another device with a USB cable.
USB LUN SET	MULTI, SINGLE	Improves compatibility by limiting the functions of the USB connection. <ul style="list-style-type: none"> Set to [MULTI] under normal conditions. Set to [SINGLE] if you are unable to connect using the [MULTI] setting.
OPERATION TIME		Displays the total hours of operation in 10-hour units.
OPTION	WIRELESS TC LINK	Checks the installation status of options sold separately. Also used to start installation after purchasing option software. <ul style="list-style-type: none"> For details about installation, refer to the installation guide for the option software.

OTHERS		
Menu item	Sub-items/Settings	Description
VERSION DISPLAY		
		Displays the version of your camcorder. <ul style="list-style-type: none"> • Be sure to check for firmware updates. • To perform an update, use the AC Adaptor.
CALIBRATION		
INITIALIZE		
		Calibrates the touch panel (p. 161). Resets all settings, including the clock setting to their default values. <ul style="list-style-type: none"> • The contents configured in a picture profile are not reset.

EDIT menu

You can display the [EDIT] menu by pressing the MENU button when the THUMBNAIL or playback screen is displayed.

EDIT		
Menu item	Sub-items/Settings	Description
PROTECT	–	Protects (locks) files (p. 96).
DIVIDE	–	Divides a movie (p. 96).
DELETE	–	Deletes a movie (p. 97).

PICTURE PROFILE menu

The PICTURE PROFILE menu is displayed by pressing the ASSIGN3/PICTURE PROFILE button.

Item	Sub-items	Settings	Description
BLACK LEVEL		-15 to +15	Sets the black level.

Menu items (Continued)

Item	Sub-items	Settings	Description
GAMMA		STANDARD, STILL, CINE1, CINE2, CINE3, CINE4, ITU709, ITU709(800%), S-LOG2, S-LOG3, HLG, HLG1, HLG2, HLG3	<p>Selects a gamma curve.</p> <p>STANDARD: Standard gamma curve for movies.</p> <p>STILL: Gamma curve for still image capture.</p> <p>CINE1: Softens the contrast in dark parts and accentuates gradation changes in bright parts to produce images with subdued tones (equivalent to HG4609G33).</p> <p>CINE2: Produces a similar effect to [CINE1]. Select this to obtain images with 100% video signal for editing or other purposes (equivalent to HG4600G30).</p> <p>CINE3: Increases contrast between bright areas and dark areas more than [CINE1], and accentuates gradation changes in blacks.</p> <p>CINE4: Increases contrast in dark areas more than [CINE3]. The dark area contrast is weaker and the bright area contrast is stronger than that of [STANDARD].</p> <p>ITU709: Gamma curve equivalent to ITU-709. Gain in low intensity area: 4.5.</p> <p>ITU709(800%): Gamma curve for checking scenes when shooting using [S-LOG2] or [S-LOG3].</p> <p>S-LOG2: [S-LOG2] gamma curve. This setting presumes editing in post-production after recording.</p> <p>S-LOG3: [S-LOG3] gamma curve. Gamma curve with characteristics similar to film, and which presumes editing in post-production after recording.</p> <p>HLG: Gamma curve for shooting in HDR. Setting equivalent to ITU-R BT.2100.</p> <p>HLG1: Gamma curve for shooting in HDR using [HLG1]. This mode prioritizes noise suppression. However, the dynamic range that can be shot is narrower than [HLG2] and [HLG3].</p> <p>HLG2: Gamma curve for shooting in HDR using [HLG2]. Setting with balance between dynamic range and noise suppression.</p> <p>HLG3: Gamma curve for shooting in HDR using [HLG3]. Setting that provides wider dynamic range than [HLG2]. However, the noise level rises.</p>

Item	Sub-items	Settings	Description	
BLACK GAMMA	Corrects gamma in low intensity areas.			
	• [BLACK GAMMA] is disabled when [GAMMA] is set to [HLG], [HLG1], [HLG2], or [HLG3].			
	RANGE	HIGH, MIDDLE, LOW	Selects the correction range.	
	LEVEL	-7 (maximum black compression) to +7 (maximum black stretch)	Sets the correction level.	
KNEE	MODE	AUTO, MANUAL	Selects the mode. AUTO: Sets the knee point and slope automatically. MANUAL: Sets the knee point and slope manually.	
	AUTO SET	Settings when [AUTO] is selected.		
		MAX POINT	90% to 100%	MAX POINT: Sets the maximum value of the knee point.
		SENSITIVITY	HIGH, MIDDLE, LOW	SENSITIVITY: Sets the sensitivity.
	MANUAL SET	Settings when [MANUAL] is selected.		
		POINT	75% to 105%	POINT: Sets the knee point.
	SLOPE	-5 (gentle) to +5 (steep)	SLOPE: Sets the knee slope. • [KNEE] is disabled when set to +5.	

Menu items (Continued)

Item	Sub-items	Settings	Description
COLOR MODE		STANDARD, STILL, CINEMA, PRO, ITU709 MATRIX, B/W, S-GAMUT/ 3200K, S-GAMUT/ 4300K, S-GAMUT/ 5500K, S-GAMUT3. CINE/3200K, S-GAMUT3. CINE/4300K, S-GAMUT3. CINE/5500K, S-GAMUT3/ 3200K, S-GAMUT3/ 4300K, S-GAMUT3/ 5500K, BT.2020, 709	<p>Sets the type and level of color.</p> <p>STANDARD: Suitable colors when [GAMMA] is set to [STANDARD].</p> <p>STILL: Suitable colors when [GAMMA] is set to [STILL].</p> <p>CINEMA: Suitable colors when [GAMMA] is set to [CINE1].</p> <p>PRO: Natural color tone when [GAMMA] is set to [ITU709].</p> <p>ITU709 MATRIX: Colors corresponding to ITU-709</p> <p>B/W: Black and white</p> <p>S-GAMUT (/3200K/4300K/5500K): Use when [GAMMA] is [S-LOG2]. This setting assumes editing in post-production. Can be selected in combination with three different color temperatures.</p> <p>S-GAMUT3.CINE (/3200K/4300K/5500K): Use when [GAMMA] is [S-LOG3]. This setting assumes editing in post-production.</p> <p>Enables shooting in color space with simple conversion to digital cinema color space. Can be selected in combination with three different color temperatures.</p> <p>S-GAMUT3 (/3200K/4300K/5500K):</p> <p>Use when [GAMMA] is [S-LOG3]. This setting assumes editing in post-production.</p> <p>Enables shooting in wide color space. Can be selected in combination with three different color temperatures.</p> <p>BT.2020: Standard color tone when [HLG], [HLG1], [HLG2], or [HLG3] is selected for [GAMMA].</p> <p>709: Color tone for recording HDTV format (BT.709) color when [HLG], [HLG1], [HLG2], or [HLG3] is selected for [GAMMA].</p> <ul style="list-style-type: none"> • This differs from [ITU709] above. • When [GAMMA] is set to [HLG], [HLG1], [HLG2], or [HLG3], [COLOR MODE] can only be set to [BT.2020] or [709].
SATURATION		-32 (light) to +32 (dark)	Sets the color saturation.

Item	Sub-items	Settings	Description
COLOR PHASE		-7 (greenish) to +7 (reddish)	Sets the color phase.
COLOR DEPTH	R	-7 (light red) to +7 (deep red)	Sets the color depth for each color phase. The darker the color, the greater the effect. No effect is applied for subjects lacking color. The subject looks darker and colors look deeper as you increase the setting value to the positive side, and brighter and lighter as you decrease the value to the negative side.
	G	-7 (light green) to +7 (deep green)	
	B	-7 (light blue) to +7 (deep blue)	
	C	-7 (light cyan) to +7 (deep cyan)	
	M	-7 (light magenta) to +7 (deep magenta)	
	Y	-7 (light yellow) to +7 (deep yellow)	

Menu items (Continued)

Item	Sub-items	Settings	Description
COLOR CORRECTION			<p>Sets the color correction.</p> <ul style="list-style-type: none"> Setting both memories to the same setting doubles the color correction effect. The settings of [COLOR CORRECTION] will be retained even if the power is turned off. However, if you want to correct colors that may change according to time of the day, weather, location, etc., it is recommended that you set [COLOR CORRECTION] again prior to recording. Changing the white balance value or the settings of [WB SHIFT], [SATURATION] or [COLOR PHASE] of the picture profile will change the color settings and colors that are corrected. If the above settings have been changed since [COLOR CORRECTION] was configured, check the [COLOR CORRECTION] settings prior to recording. During the automatic white balance adjustment, the white balance value automatically varies according to the lighting of the subject. Manual white balance adjustment is recommended when you use [COLOR CORRECTION].
	TYPE	OFF, COLOR REVISION, COLOR EXTRACT	<p>Selects the color correction type.</p> <p>OFF: Do not perform color correction.</p> <p>COLOR REVISION: Corrects the colors configured in memory.</p> <ul style="list-style-type: none"> Colors not configured in memory (displayed in black and white when [COLOR EXTRACT] is set) will not be corrected. <p>COLOR EXTRACT: Displays only the colors that are configured in memory in color.</p> <ul style="list-style-type: none"> The other areas are displayed in black and white. You can use this function as an effect in your movies or to check the colors configured in memory.
	MEMORY SELECTION	1, 2, 1&2	<p>Selects a memory to enable.</p> <p>1: Enables memory 1 settings only.</p> <p>2: Enables memory 2 settings only.</p> <p>1&2: Enables settings in both memory 1 and 2.</p>

Item	Sub-items	Settings	Description	
COLOR CORRECTION	MEMORY1 COLOR	PHASE	0 (purple) to 8 (red) to 16 (yellow) to 24 (green) to 31 (blue)	Sets the color phase of memory 1.
		PHASE RANGE	0 (no color selection), 1 (narrow: to select only a single color) to 31 (wide: to select multiple colors with similar color phase)	Sets the phase range of memory 1.
		SATURATION	0 (to select light colors to dark colors) to 31 (to select dark colors only)	Sets the saturation of memory 1.
		ONE PUSH SET	–	Automatically sets [PHASE] for the subject at the center of the center marker. [SATURATION] is reset to 0.
MEMORY1 REVISION	PHASE	–15 to +15	Corrects the phase of the color selected in memory 1. <ul style="list-style-type: none"> • When set to 0, the color is not corrected. 	
		SATURATION	–15 to +15	Corrects the saturation of the color selected in memory 1. <ul style="list-style-type: none"> • When set to 0, the color is not corrected.
MEMORY2 COLOR		–	Sets the color configured in memory 2. See [MEMORY1 COLOR] for description and settings.	
MEMORY2 REVISION		–	Corrects the color in memory 2. See [MEMORY1 REVISION] for description and settings.	

Menu items (Continued)

Item	Sub-items	Settings	Description	
WB SHIFT	Sets the white balance shift.			
	• Items you can adjust differ depending on the filter type.			
	FILTER TYPE	LB-CC, R-B	Selects a color filter type for the white balance shift. LB-CC: Film type (color temperature conversion and color correction) R-B: Video type (correction of R and B levels)	
	LB[COLOR TEMP]	-9 (bluish) to +9 (reddish)	Sets the color temperature offset value.	
	CC[MG/GR]	-9 (greenish) to +9 (magentish)	Sets the color correction offset value.	
	R GAIN	-9 (low R level) to +9 (high R level)	Sets the R level.	
B GAIN	-9 (low B level) to +9 (high B level)	Sets the B level.		
DETAIL	Sets the detail.			
	LEVEL	-7 to +7	Sets the DETAIL level.	
	MANUAL SET	ON/OFF	ON, OFF	Turns manual DETAIL adjustment on/off. Set to [ON] to enable manual DETAIL adjustment (automatic optimization will not be performed).
	V/H BALANCE	-2 (stronger vertical (V) DETAIL) to +2 (stronger horizontal (H) DETAIL)	Sets the balance between vertical (V) DETAIL and horizontal (H) DETAIL.	
	B/W BALANCE	TYPE1 (stronger black (B) DETAIL) to TYPE5 (stronger white (W) DETAIL)	Selects the balance between black (B) DETAIL for low luminance areas and white (W) DETAIL for high luminance areas.	

Item	Sub-items	Settings	Description
DETAIL	LIMIT	0 (low limit level (likely to be limited)) to 7 (high limit level (not likely to be limited))	Sets the limit level of the DETAIL.
	CRISPENING	0 (shallow crispening level) to 7 (deep crispening level)	Sets the crispening level.
	HI-LIGHT DETAIL	0 to 4	Sets the DETAIL level in the high intensity areas.
COPY		–	Copies the settings of the picture profile to another picture profile number.
RESET		–	Resets the picture profile to the default setting.

Troubleshooting

If you run into any problems using your camcorder, follow the flow chart below.

① Check your camcorder, referring to the items on pages 136 to 143.

② Disconnect the power source, reconnect the power source after about 1 minute and turn on your camcorder.

③ Select  (OTHERS) → INITIALIZE.
This operation will reset the date, time, and area settings.

④ Consult your Sony dealer or local authorized Sony service facility.

- Power sources/LCD screen/Wireless Remote Commander (p. 136)
- Memory cards (p. 138)
- Recording (p. 138)
- Playback (p. 141)
- Connecting to TV (p. 142)
- Copying/Editing/Connecting to other devices (p. 143)
- Connecting to a computer (p. 143)

Power sources/LCD screen/Wireless Remote Commander

The power does not turn on or abruptly turns off.

- Attach a charged battery pack to the camcorder (p. 21).
- Use the AC Adaptor to connect the camcorder to a wall outlet (wall socket) (p. 21).

The camcorder does not operate even when the power is set to on.

- Disconnect the power source (battery or AC Adaptor), then reconnect it after about 1 minute.
- Select  (OTHERS) → INITIALIZE.

The camcorder gets warm.

- Camera body may get warm with use — this is normal.

The POWER/CHG lamp is not lit while charging the battery pack.

- Turn off the power.
- Reattach the battery pack correctly.
- Re-insert the plug in the power outlet correctly.
- The battery pack is already fully charged.

The POWER/CHG lamp flashes while charging the battery pack.

- The battery pack may not be able to be charged if the temperature of the battery pack is too high or too low.
- Reattach the battery pack correctly.
- If the lamp continues to flash, there may be a problem with the camcorder. Disconnect the plug from the power outlet, and contact a service representative.

The remaining battery indicator does not indicate the correct figure.

- Ambient temperature is too high or too low, or the battery pack has not been charged enough. This is not a malfunction.
- Fully charge the battery again. If the problem persists, the battery may be worn-out. Replace with a new battery (p. 21, 158).
- The indicated figure may not be correct in certain circumstances. For example, when you open or close the LCD screen, it takes about 1 minute to display the correct remaining battery.

The battery pack discharges too quickly.

- Ambient temperature is too high or too low, or the battery pack has not been charged enough. This is not a malfunction.
- Fully charge the battery again. If the problem persists, the battery may be worn-out. Replace with a new battery (p. 21, 158).

Grid-like points are visible on the panel.

- This is not a malfunction. These points are normal results of the manufacturing process and do not affect the recording in any way.

The image on the viewfinder is not clear.

- Move the diopter adjustment dial until the image is clear (p. 26).

The touch panel is open, but the LCD screen is not displayed.

- The LCD screen is not displayed if the eye sensor detects something nearby and the camcorder switches to viewfinder view.

The supplied Wireless Remote Commander does not function.

- Set [REMOTE CONTROL] to [ON] (p. 126).
- Remove any obstructions between the Wireless Remote Commander and the remote sensor of the camcorder.
- Detach the lens hood (supplied).
- Keep strong light sources, such as sunlight or overhead lighting, away from the remote sensor, otherwise the Wireless Remote Commander may not function properly.
- Change the battery. Insert a fresh battery with the +/- terminals aligned correctly (p. 16).

Another video device malfunctions when you use the supplied Wireless Remote Commander.

- Select a commander mode other than DVD2 for your video device.
- Cover the sensor of your video device with black paper.

Memory cards

The camcorder does not operate with the memory card inserted.

- The memory card was formatted on a computer. Format it on this camcorder (p. 98).
- The memory cards that are supported vary depending on the file format setting (p. 27).

The data file name is incorrect, or flashing.

- The file is damaged.
- The file format is not supported on your camcorder (p. 157).

The memory card indicator is flashing.

- An error occurred with the memory card during recording. Stop recording of all memory cards, and repair the database file.

Images on the memory card cannot be deleted.

- You can select no more than 100 images to be deleted on the edit screen.
- The images are protected. Unprotect the images (p. 96).

Cannot play back or memory card is not recognized on another device.

- The playback device does not support playback of the memory card.

Recording

The recording does not start when you press the START/STOP button.

- The playback screen is displayed. Finish playback operation (p. 66).
- The previously shot scene is still being written to the memory card. Shooting a new scene cannot start while writing data.
- There is no empty space on the memory card. Replace the memory card with a new one or format the memory card (p. 98). Delete unnecessary images (p. 97).
- Total number of movie scenes exceeds the recordable capacity of your camcorder (p. 150). Delete unnecessary images (p. 97).
- The temperature of your camcorder is extremely high. Turn off your camcorder and leave it for a while in a cool place.
- The temperature of your camcorder is extremely low. Turn off your camcorder and leave it for a while in a warm place.
- An error occurred with the memory card during recording. Stop recording of all memory cards, and repair the database file.

The handle zoom does not work.

- Set the handle zoom speed switch to FIX or VAR (p. 33).

The access lamp remains lit even after recording was stopped.

- Your camcorder is recording the scene you have just shot on the memory card.

The imaging field looks different.

- The imaging field may look different depending on the condition of your camcorder. This is not a malfunction.

The actual recording time for movies is less than the estimated recording time.

- Depending on the recording conditions, the time available for recording may be shorter, for example when recording a fast moving object, etc. (p. 149).

Recording stops.

- Recording may stop if the camcorder is subjected to repeated vibration.

The camcorder does not keep the setting changes.

- Some menu items return to the default setting when the power is turned off.
- The [FOCUS MAGNIFIER] setting is not stored.
- The battery pack or AC Adaptor was disconnected while the power was turned on. Before disconnecting the battery pack or AC Adaptor, turn off the power and make sure that the access lamp is turned off.

There is a time difference between the point when the START/STOP button is pressed and the point that the recording movie actually starts or stops.

- On your camcorder, there may be a slight time difference between the point where you press the START/STOP button and the actual point that recording movie starts/stops. This is not a malfunction.

Automatic focus does not function.

- Press the AF/MF button (p. 35) to set the focus to automatic adjustment.
- Adjust the focus manually if the automatic focus does not work properly (p. 35).

The phase detection AF frame display is not visible.

- The camcorder may have switched to contrast AF mode due to the subject conditions or user settings. This is not a malfunction.

Image stabilization is not working.

- Set [STEADYSHOT] to [ACTIVE] or [STANDARD].

Troubleshooting (Continued)

- SteadyShot image stabilization may not be able to correct the image if the shaking is too large, even if [STEADYSHOT] is set to [ACTIVE] or [STANDARD].

Image cannot be recorded or played back properly.

- If you continue recording and deleting images on recording media for a long period of time, the files on that media may become fragmented. As a result, you may not be able to record and save images properly.
Back up the image data, then format the media using [MEDIA FORMAT].

Menu items are grayed out or do not work.

- You cannot select grayed out display items in the current recording/playback situation.
- There are some functions you cannot activate simultaneously. The following list shows examples of unworkable combinations of functions and menu items.

Cannot use (menu disabled)	Situation
[ON/OFF] of [AE SHIFT]	All of iris, ISO sensitivity/gain, and shutter speed are set manually.
[ZEBRA], [PEAKING]	[COLOR BAR] is set to [ON].
[ON/OFF] of [MARKER]	[FOCUS MAGNIFIER] is set to [ON].
[TC PRESET]	[TC MAKE] is set to [REGENERATE].
[COLOR BAR]	Movies are being recorded. [FOCUS MAGNIFIER] is set to [ON].

The settings of menu items change.

- When the AUTO/MANUAL switch is set to AUTO, settings related to picture quality automatically change.

Iris, ISO sensitivity/gain, shutter speed, or white balance cannot be adjusted manually.

- Set the AUTO/MANUAL switch to MANUAL.

Tiny spots in white, red, blue, or green appear on the LCD screen.

- This phenomenon appears when using a slow shutter speed (p. 44). This is not a malfunction.

The subjects passing by the frame very fast appear crooked.

- This is called focal plane phenomenon. This is not a malfunction. Because of the way that the image device (CMOS sensor) reads out image signals, the subjects passing by the frame rapidly might appear crooked depending on the recording conditions.

Horizontal stripes appear on the image.

- This occurs when recording pictures under a fluorescent lamp, sodium lamp, or mercury lamp. This is not a malfunction. This can be improved by changing the shutter speed (p. 44).

Black bands appear when you record a TV screen or computer screen.

- Adjust the shutter speed (p. 44).

Fine patterns flicker, diagonal lines look jagged.

- Adjust [DETAIL] to the negative side (p. 134).

The timecode is not recorded in sequence.

- The timecode may not be recorded sequentially if you change the settings of [REC FORMAT].

Image color is not correct.

- Cancel NIGHTSHOT (p. 54).

The image is not visible because the screen is too bright.

- Cancel NIGHTSHOT (p. 54).

Cannot adjust [LCD BRIGHT].

- [LCD BRIGHT] cannot be adjusted in the following cases.
 - The LCD screen is in the stowed position with the screen facing outward.
 - When using the AC Adaptor.

Playback

See “Memory cards” (p. 138).

The desired images cannot be found.**Images cannot be played back.**

- Select the memory card and image quality of the image you want to play back on the THUMBNAIL screen (p. 65).
- Image data cannot be played back if you have modified file names or folders, or have edited the data on a computer. This is not a malfunction.
- Images recorded on other devices may not be played back, or displayed in incorrect size. This is not a malfunction.
- Display the THUMBNAIL screen, touch twice on the thumbnail you want to play, or select the thumbnail and press the ▲/▼/◀/▶/SET button (p. 65).

The data file name is incorrect, or flashing.

- The file is damaged.
- The file format is not supported on your camcorder (p. 157).
- Only the file name is displayed, if the folder structure does not conform to the universal standard.

Audio is not recorded properly.

- If an external microphone or other device is connected or disconnected while recording a movie, the audio may not be recorded properly. Audio is recorded properly by restoring the connection state of the microphone that was in force at the start of recording.
 - Audio is not recorded if [AUDIO REC LEVEL] is adjusted so that the volume is set to the minimum.
-

No sound or only a low sound is heard.

- Turn up the playback volume (p. 66).
-

“---” is displayed on the LCD screen.

- Bars will be displayed for the camera data of the movies recorded with [COLOR BAR] set to [ON].
-

Multi ch appears on the LCD screen.

- Multi ch appears when you play back movies recorded with 5.1ch surround sound. 5.1ch surround sound is down-mixed to 2ch stereo and played back on your camcorder.

Connecting to TV

Neither image nor sound is played back on the TV connected with the HDMI cable.

- Images are not output from the HDMI OUT jack if copyright protection signals are recorded in the images.
 - Signals are not output from the HDMI OUT jack when the USB jack is connected.
-

Neither image nor sound is played back on the TV, projector, or AV amplifier connected with the HDMI cable.

- If you cannot view images or hear sound on the TV, projector, or AV amplifier connected with the HDMI cable, try disconnecting and connecting the HDMI cable, or turn on your camcorder again.
-

The image appears distorted on a 4:3 TV.

- This happens when viewing a movie recorded in 16:9 (wide) mode on a 4:3 TV. Select  (REC/OUT SET) → [VIDEO OUT] → [DOWN CONVERT TYPE] and set the appropriate down conversion type (p. 114).
-

Black zone appears at top and bottom of a 4:3 TV screen.

- This happens when viewing a movie recorded in 16:9 (wide) mode on a 4:3 TV. This is not a malfunction.

Copying/Editing/Connecting to other devices

Timecode and other information appear on the display of the connected device.

- Set [DISPLAY OUTPUT] to [LCD PANEL] (p. 122).

Copy cannot be done correctly using the A/V connecting cable (sold separately).

- The A/V connecting cable (sold separately) is not connected properly. Make sure that the A/V connecting cable (sold separately) is connected to the input jack of the device.

Sound cannot be added after recording.

- You cannot add sound after recording on your camcorder.

Copy cannot be done correctly using the HDMI cable.

- You cannot copy movies using the HDMI cable.

Cannot divide movies.

- The following types of movie cannot be divided.
 - Movies with a very short recording duration.
 - XAVC S 4K and XAVC S HD movies
- Cancel file protection and then try to divide.

Connecting to a computer

The computer does not recognize the camcorder.

- Disconnect the cable from the computer, then connect it again securely.
- Disconnect the cable from your computer and camcorder. Reboot your computer, and connect your computer and camcorder following the steps in the correct order.

Movies cannot be viewed or copied to the computer.

- Disconnect the cable from the computer, then connect it again.
- Software must be installed to copy movies to your computer (p. 19).

Warning indicators and messages

Self-diagnosis display/Warning indicators

When an error occurs, a warning indicator appears on the LCD screen or in the viewfinder.

You can fix some problems associated with the symptoms yourself. If the problem persists even after you have tried a couple of times, contact your Sony dealer or local authorized Sony service facility.

C:04:□□

- The battery pack is not an “InfoLITHIUM” battery pack. Use an “InfoLITHIUM” battery pack (p. 158).
- Connect the DC plug of the AC Adaptor firmly to the DC IN jack of the camcorder.

C:06:□□

- The battery pack is too hot. Replace the battery pack, or remove the battery pack and put it in a cool place.

C:13:□□

- Remove the memory cards. After installing them again, operate your camcorder.

C:32:□□

- Remove the power source. Reconnect it and operate your camcorder again.

E:□□:□□

- Try steps ② to ④ on page 136.

(Battery level warning)

- The battery pack is nearly used up.
- Depending on the operation, environment, or battery conditions, the indicator may flash, even if around 10% is displayed as the battery remaining figure.

(Warning indicators pertaining to battery pack temperature)

- The battery pack is too hot. Replace the battery pack, or remove the battery pack and put it in a cool place.

(Warning indicators pertaining to memory cards)

Slow flashing

- Free space for recording images are running out. For the type of memory cards you can use with your camcorder, see page 27.
- No memory card is inserted (p. 27).

Fast flashing

- There is not enough free space for recording images. Delete unnecessary images (p. 97), or format the memory card (p. 98) after you save the images to your computer or another device.
- The image database file may be damaged (p. 99).

(Warning indicators pertaining to memory card formatting)*

- The memory card is damaged.
- The memory card is not formatted correctly (p. 98).

(Warning indicators pertaining to incompatible memory cards)*

- Incompatible memory card is inserted (p. 27).

(Warning indicators pertaining to the write-protect of the memory card)*

- The write-protect switch is set to lock position on the memory card.

- Access to the memory card was restricted on another device.

* When [BEEP] is set to [ON] (p. 126), you hear a melody when the warning indicators appear on the LCD screen.

Description of warning messages

If a warning message is displayed, follow the instructions.

Memory cards

Inconsistencies found in image database file. Do you want to repair the image database file?

Inconsistencies found in image database file. Cannot record or play HD movies. Do you want to repair the image database file?

- You cannot record or play back movies because no movie management information exists. If you touch [OK], new management information is created and you can record or play back movies.

Inconsistencies found in the image database file. Back up and recover. Recover, then import using the included PC software.

- Inconsistencies occur in the image database file because movie management information is damaged. If you touch [OK], new management information is created by backing up a movie. The backed up movies cannot be recognized. If you connect a computer on which application software is installed to the camcorder, you can copy the backed up movies to the computer. However, the loading of all moves is not guaranteed.

Buffer overflow. Writing to the media was not completed in time.

- You have performed recording and erasing operations repeatedly, or a memory card that has been formatted by other device is used. Back up the data to another device (such as a computer HDD), and then [Empty] the memory card on the camcorder (p. 98).
- The size of the inserted memory card is not sufficient for copying the movie(s). Use the recommended memory card (p. 27).

Recovering data.

- Your camcorder tries to recover data automatically if the data writing was not performed properly.

Cannot recover data.

- Writing data onto the media of the camcorder has failed. Attempts were made to recover the data, but they were unsuccessful.

Reinsert the memory card.

- Reinsert the memory card a few times. If even then the indicator flashes, the memory card could be damaged. Try with another memory card.

Cannot recognize this memory card. Format and use again.

- Format the memory card using the camcorder (p. 98). Note that if you format the memory card, all the recorded movies and photos are deleted.

This memory card may not be able to record or play movies.

- Use a memory card recommended for your camcorder (p. 27).

This memory card may not be able to record or play images correctly.

- Use a memory card recommended for your camcorder (p. 27).
- Contact your Sony dealer.

Do not eject the memory card during writing. Data may be damaged.

- Reinsert the memory card, and follow the instructions on the LCD screen.

Other

Maximum number of images already selected.

- You can select only 100 images at one time for:
 - Deleting movies/photos
 - Protecting movies/photos, or releasing the protection

Protected file. Cannot delete.

- An attempt was made to delete protected data. Release the protection of the data.

Error messages

The following error messages may appear if trouble occurs during streaming distribution connection or Wireless TC LINK connection. Try the solution suggested on the display.

No registered access point.

There are no access points registered. Select  (NETWORK SET) → [Wi-Fi SET] → [ACCESS POINT SET], and register an access point.

Cannot find connectable access point.

Set the access point setting.

An access point could not be found. Select  (NETWORK SET) → [Wi-Fi SET]

→ [ACCESS POINT SET], and check the access point settings.

Connection to the access point failed.

Please input your password again.

Could not connect to the access point. Try re-entering the password for the access point.

Connection with an access point disconnected.

Check the connection condition.



Connection to the access point was disconnected. Check the access point connection conditions.

No response from the access point.

There was no response from the access point. Check the connection with the access point.

Failed to acquire an IP address.

Change the IP address setting.

Could not acquire the IP address. If connecting to a network via a wireless LAN, select  (NETWORK SET) → [Wi-Fi SET] → [ACCESS POINT SET], and specify the IP address manually. If connecting to a network via a wired LAN, select  (NETWORK SET) → [WIRED LAN SET], and specify the IP address manually.

Failed to acquire an IP address.

Check the DNS server setting.

Could not acquire the IP address. Check the DNS server settings.

Network error occurred.

A Wi-Fi communication error occurred.

Check the USB device connection.

Check the USB device connection.

Cannot use this USB device.

Connect a correct USB device.

Check the LAN cable connection.

Could not connect to the network. Check the LAN cable connection.

Cannot authenticate with WEP.
The password is wrong or automatic acquisition of an IP address has failed.

Check the password (WEP key). Check the DHCP settings of the access point.

Cannot authenticate with WEP.
The password is wrong or the IP address setting is wrong.

Check the password (WEP key). Check the IP address setting of the camcorder.

Cannot execute functions.

Restart the camcorder. If the problem persists, contact a service representative.

Failed to connect to the Ustream server.
Check the "CLOCK SET".

Check that the camcorder clock is set to the correct time.

Ustream error occurred.

Try to restart streaming. Check the status of the USTREAM service.
(<http://www.ustream.tv/>)

User name or the password is invalid.

There may be an input error in the user name or password. Check that the entered user name and password are correct.

The server rejected the request.

Try to restart streaming. Check the status of the USTREAM service.
(<http://www.ustream.tv/>)

Authentication information is invalid.
Check the user name and password.

Check  (NETWORK SET) → [USTREAM] → [USER INFO SET] settings.

An invalid channel has been specified.

Specify a valid channel and try to restart streaming.

Connection to the server terminated.
Check the communication environment.

Reconnect using a stable communications environment.

There is a possibility that the movie was not saved correctly on the server.

Check whether or not the movie was saved on the server.

Not enough stream time.
Could not be saved to the server.

Increase the time period for streaming.

Could not verify the certificate.
Continue connection?

Obtain and import a root certificate. For details about importing a root certificate, see page 94.

Also, check that the clock setting of the camcorder is set to the correct date and time.

Unable to access the media.

The memory card could not be loaded. The memory card may be damaged.

Could not connect to the server.
Check "DESTINATION SET".

Check  (NETWORK SET) → [RTMP/RTMPS] → [DESTINATION SET] settings.

Warning indicators and messages (Continued)

Closes the function since an error occurred.

The function terminated due to an error occurring.

Recording time

Estimated time of recording and playback with each battery pack

Approximate time available when you use a fully charged battery pack.

Recording time

(Unit: minute)

Battery pack	Continuous recording time	Typical recording time
NP-FV70A	155	75

Notes

- Recording format
XAVC S 4K 2160/30p 60Mbps
- Using an ECM-XM1 microphone connected to the INPUT1 jack.
- Using an XLR microphone with [LCD BRIGHT] set to [NORMAL]
- Using a memory card
- Using the LCD screen
- Typical recording time shows the time when you repeat recording start/stop, turning on/off, and so on.
- Times measured when using the camcorder at 25 °C (77 °F).
- Both recording and playback time will be shorter when you use your camcorder in low temperatures. It is recommended that you use the camcorder from 10 °C to 30 °C (50 °F to 86 °F).
- The recording and playback time will be shorter depending on the conditions under which you use your camcorder.

Playing time

(Unit: minute)

Battery pack	
NP-FV70A	265

Estimated recording time

(Unit: minute)

XAVC S 4K

4K (QFHD)	2160	
	60Mbps	100Mbps
64GB	125 (125)	75 (75)

4K(QFHD)+ PROXY(9M)	2160	
	60Mbps	100Mbps
64GB	110 (110)	70 (70)

4K(QFHD)+ PROXY(3M)	2160	
	60Mbps	100Mbps
64GB	120 (120)	75 (75)

XAVC S HD

XAVC S	1080				
	100 Mbps	60 Mbps	50 Mbps	25 Mbps	16 Mbps
64GB	75 (75)	125 (125)	150 (150)	300 (300)	465 (465)

XAVC S+ PROXY (9M)	1080				
	100 Mbps	60 Mbps	50 Mbps	25 Mbps	16 Mbps
64GB	70 (70)	110 (110)	130 (130)	220 (220)	300 (300)

XAVC S+ PROXY (3M)	1080				
	100 Mbps	60 Mbps	50 Mbps	25 Mbps	16 Mbps
64GB	75 (75)	120 (120)	145 (145)	265 (265)	390 (390)

Recording time (Continued)

AVCHD

■ When [AVCHD AUDIO FORMAT] is set to [LINEAR PCM]

(Unit: minute)

	<u>PS</u>	<u>FX</u>	<u>FH</u>	<u>HQ</u>	<u>LP</u>
16GB	70 (70)	80 (80)	110 (110)	180 (140)	285 (250)
32GB	140 (140)	165 (165)	220 (220)	370 (290)	585 (505)
64GB	290 (290)	335 (335)	450 (450)	750 (585)	1185 (1020)

■ When [AVCHD AUDIO FORMAT] is set to [DOLBY DIGITAL]

(Unit: minute)

	<u>PS</u>	<u>FX</u>	<u>FH</u>	<u>HQ</u>	<u>LP</u>
16GB	75 (75)	85 (85)	120 (120)	215 (160)	375 (305)
32GB	150 (150)	175 (175)	245 (245)	435 (330)	765 (620)
64GB	305 (305)	360 (360)	495 (495)	880 (665)	1540 (1255)

- When using Sony memory cards.
- The number in () is the minimum recordable time.

Note

- The recording time may vary depending on the recording conditions, subjects, and [REC SET] (p. 111).

Tips

- The maximum number of scenes that can be recorded is 600 in XAVC S HD/4K, and 3,999 in AVCHD.
- The maximum continuous recording time is 6 hours for XAVC S HD/4K, and 13 hours for AVCHD.
- Your camcorder uses the VBR (Variable Bit Rate) format to automatically adjust image quality to suit the recording scene. This technology causes fluctuations in the recording time of the media. Movies containing quickly moving and complex images are recorded at a

higher bit-rate, and this reduces the overall recording time.

- Bit-rate (movie + audio, etc.), number of pixels, and aspect ratio of each recording mode of movies are as follows.
 - XAVC S 4K
 - 100 Mbps 3,840×2,160/16:9
 - 60 Mbps 3,840×2,160/16:9
 - XAVC S HD
 - 100Mbps 1,920×1,080/16:9
 - 60Mbps 1,920×1,080/16:9
 - 50Mbps 1,920×1,080/16:9
 - 25Mbps 1,920×1,080/16:9
 - 16Mbps 1,920×1,080/16:9
 - AVCHD
 - PS: max. 28 Mbps 1,920×1,080/16:9
 - FX: max. 24 Mbps 1,920×1,080/16:9
 - FH: approx. 17 Mbps (ave.) 1,920×1,080/16:9
 - HQ: approx. 9 Mbps (ave.) 1,280×720/16:9
 - LP: approx. 5 Mbps (ave.) 1,440×1,080/16:9

Function limitations when recording

For details about limitation when streaming is ON, see page 84.

Limitations for each file format

Yes: Supported, No: Not supported

Functions	XAVC S 4K	XAVC S HD	AVCHD
RELAY REC (p. 31)	Yes	Yes	Yes
SIMULTANEOUS REC (p. 32)	Yes	Yes	Yes
FACE DETECTION (p. 39)	Yes	Yes	Yes
PROXY REC MODE (p. 42)	Yes	Yes (60fps or lower)	No
RELAY REC + PROXY REC MODE	Yes	Yes (60fps or lower)	No
SIMULTANEOUS REC + PROXY REC MODE	Yes	Yes (60fps or lower)	No
HIGH FRAME RATE (p. 60)	No	Yes	No
S&Q MOTION (p. 59)	Yes	Yes	Yes
SUPER SLOW MOTION (p. 60)	No	Yes	Yes
STREAMING (p. 83)	Yes (60 Mbps only)	Yes	Yes
RTMP/RTMPS (p. 86)	No	Yes	Yes
USTREAM (p. 89)	No	Yes	Yes
COLOR BAR (p. 110)	No	Yes (when proxy recording is OFF)	Yes
DATE REC (p. 126)	No	Yes (Interlaced recording)	Yes (Interlaced recording)

Function limitations when recording (Continued)

Slow & Quick Motion and Super Slow Motion recording limitations

Yes: Supported, No: Not supported

Functions	Slow & Quick Motion	Slow motion at high frame rate	Super Slow Motion
FACE DETECTION	No	No	No
LOCK-ON AF	Yes	No	No
COLOR BAR	No	No	No
STREAMING	No	No	No
RTMP/RTMPS	No	No	No
USTREAM	No	No	No
DATE REC	No	No	No
SIMULTANEOUS REC/RELAY REC	No	No	No
PROXY REC MODE	No	No	No
Wi-Fi remote control	No	No	No
Auto mode shooting	No	No	No
HISTOGRAM	Yes	Yes	No
PEAKING	Yes	Yes	Yes
ZEBRA	Yes	Yes	Yes
WB SET	Yes	Yes	No
CLEAR IMAGE ZOOM	Yes	No	No
AUTO BACK LIGHT	Yes	No	No
Audio recording	No	No	No
Shutter speed auto adjustment	No	No	No
Camera shake correction (STEADYSHOT)	Yes	Yes	Yes
D. EXTENDER	Yes	No	No

Streaming, RTMP/RTMPS, and USTREAM supported formats

🔗 Notes

- Only streaming is supported if the original file is in 4K format with bit rate of 60Mbps.
- Proxy recording is not supported in the following cases.
 - If the original file is in 4K format with bit rate of 100Mbps
 - If the frame rate of the original file is 120/100p
 - In AVCHD format and the frame rate of the original file is 60/50p

Original file (XAVC S)		Streaming data			
Image size		1,280×720		640×360	
–	Frame rate (fps)	30(25)p	24p	30(25)p	24p
	Bit rate (Mbps)	3	3	1	1
24p	–		Yes		Yes
Other than 24p		Yes		Yes	

Proxy recording supported formats

Note

- Proxy recording is not supported in the following cases.
 - When [QFHD REC OUTPUT] is set to [EXTERNAL OUTPUT]
 - In AVCHD format
 - If the frame rate of the original file is 120/100p

Original file		Proxy file	
Image size		1,280×720	640×360
–	Frame rate (fps)	Same frame rate as original file	
–	Bit rate (Mbps)	9	3
–		Yes	Yes

Using your camcorder abroad

Power supply

You can use your camcorder in any country/region using the AC Adaptor supplied with your camcorder within the AC 100 V to 240 V, 50/60 Hz range.

Viewing on TV

Before recording a movie with your camcorder for viewing on a TV, set [60i/50i SEL] to the appropriate TV system for the country/region in which you intended to view the movie. The following shows which countries and regions require [60i] or [50i] setting.

Countries/regions that require [60i/50i SEL] set to [60i]

Bahama Islands, Barbados, Bermuda, Bolivia, Canada, Central America, Chile, Colombia, Costa Rica, Cuba, Dominican Republic, Ecuador, El Salvador, Guam, Guatemala, Guyana, Haiti, Honduras, Jamaica, Japan, Korea, Mexico, Micronesia, Myanmar, Nicaragua, Panama, Peru, the Philippines, Puerto Rico, Saint Lucia, Samoa, Surinam, Taiwan, Trinidad and Tobago, the U.S.A., Venezuela, etc.

Countries/regions that require [60i/50i SEL] set to [50i]

Argentina, Australia, Austria, Belgium, Brazil, Bulgaria, China, Croatia, Czech Republic, Denmark, Finland, France, French Guiana, Germany, Greece, Hong Kong, Hungary, Indonesia, Iran, Iraq, Italy, Kuwait, Malaysia, Monaco, the Netherlands, New Zealand, Norway, Paraguay, Poland, Portugal, Romania, Russia, Singapore, Slovak Republic, Spain, Sweden, Switzerland, Thailand, Turkey, Ukraine, United Kingdom, Uruguay, Vietnam, etc.

Simple setting of the clock by time difference

When you are abroad, you can easily adjust the clock to the local time by setting the

time difference. Select [AREA SET], then set the time difference (p. 125).

File/folder structure on the recording media

The file/folder structure is shown below. You do not usually need to acknowledge the file/folder structure when recording/playing back movies on the camcorder.

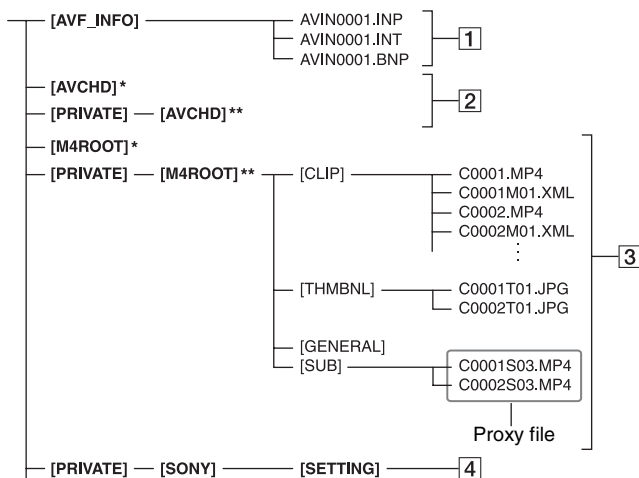

* “Memory Stick PRO Duo”

** SD memory card, SDHC memory card, SDXC memory card

1 Image management files

When you delete the files, you cannot record/play back the images correctly.

The files are defaulted as hidden files and not usually displayed.

2 AVCHD movie management information folder

This folder contains recording data of AVCHD movie files.

3 XAVC S movie management information folder

This folder contains recording data of XAVC S movie files.

The file numbers go up automatically.

4 Camera profiles

Stores camera profile data.

- Do not modify the files or folders on the camcorder from the computer. Doing so might damage image files, or prevent image files from being played back.

- Sony accepts no responsibility for the results of operation using data copied from a PC to a memory card.
- When you delete image files, follow the steps on page 97. Do not delete the image files on the camcorder directly from the computer.
- Do not format the recording media in the camcorder using a computer. The camcorder may not operate correctly.
- Do not copy the files on the recording media from a computer. Operation is not guaranteed, if you perform this operation.
- Use “Catalyst Browse” application software to import data from the recording media to a computer.
- Files may not be loaded correctly if using software other than “Catalyst Browse.”
- For details about NLE (Non-Linear Editing) use, contact the software maker.

Maintenance and precautions

About the XAVC S format

Recording and playback on your camcorder

Your camcorder can record 4K (QFHD) and HD (high definition) based on the XAVC S format.

This uses a Long-GOP video compression format for recording.

Video*: MPEG-4AVC/H.264

When [60i] is selected:

3840×2160/30p, 3840×2160/24p,
1920×1080/120p, 1920×1080/60p,
1920×1080/30p, 1920×1080/24p

When [50i] is selected:

3840×2160/25p, 1920×1080/100p,
1920×1080/50p, 1920×1080/25p

Audio: LPCM 2-ch

Recording media: Memory card

* The camcorder is not able to play back data that is recorded in XAVC S format using settings other than those described above.

About the AVCHD format

Recording and playback on the camcorder

Based on the AVCHD format, your camcorder records with the HD (high definition) image quality.

Video*: MPEG-4AVC/H.264

When [60i] is selected:

1920×1080/60p, 1920×1080/60i,
1920×1080/30p, 1920×1080/24p,
1440×1080/60i, 1280×720/60p

When [50i] is selected:

1920×1080/50p, 1920×1080/50i,
1920×1080/25p, 1440×1080/50i,
1280×720/50p

Audio: Dolby Digital 2-ch, LPCM 2-ch

Recording media: memory card (sold separately)

* Data recorded in AVCHD format other than the above mentioned cannot be played back on your camcorder.

- Because the AVCHD format uses a data compression system, images may be distorted in scenes where the image, angle, or brightness changes drastically. This is not a malfunction.

About memory cards

- A memory card formatted on a computer does not have guaranteed compatibility with your camcorder.
- Data read/write speed may vary depending on the combination of the memory card and memory card compliant product you use.
- Damaged or lost image data will not be compensated for, and may occur in the following cases:
 - If you eject the memory card, turn the power off on your camcorder, or remove the battery pack for replacement while your camcorder is reading or writing image files on the memory card (while the access lamp is lit or flashing).
 - If you use the memory card near electric fields, magnetic fields, or other sources of electromagnetic noise.
- It is recommended to make a back-up of important data on the hard disk of a computer.
- Do not attach a label or the like on memory card.
- Do not touch, or allow metallic objects to come into contact with the terminals.
- Do not bend, drop or apply strong force to the memory card.
- Do not disassemble or modify the memory card.
- Do not let the memory card get wet.
- Be careful to keep memory card out of the reach of small children. There is danger that a child might swallow it.
- Do not insert anything other than the compliant size of memory card into the memory card slot. Doing so may cause a malfunction.
- Do not use or keep the memory card in the following locations:
 - Places subject to extremely high temperature, such as a car parked outside in the summer
 - Places under direct sunlight
 - Places with extremely high humidity or subject to corrosive gases

About supported memory cards

“Memory Stick PRO Duo” media and standard size SD cards can be used with this camcorder.

- For the latest information about memory cards that can be used, visit the home page (<http://www.sony.jp/support/tr/handycam/connect/>).

On image data compatibility

- Image data files recorded on a memory card by your camcorder conform to the “Design rule for Camera File system” universal standard established by the JEITA (Japan Electronics and Information Technology Industries Association).
- If you cannot use the memory card that has been used with another device, format it with your camcorder using the procedure on page 98. Note that formatting erases all information on the memory card.
- You may not be able to play back images with your camcorder:
 - When playing back image data modified on your computer.
 - When playing back image data recorded with other devices.

About “Memory Stick” media

Types of “Memory Stick” media	Recording/ Playback
“Memory Stick Duo” (with MagicGate)	–
“Memory Stick PRO Duo” (Mark2)	Yes
“Memory Stick PRO-HG Duo”	Yes

- This unit does not support 8-bit parallel data transfer, but supports 4-bit parallel data transfer equivalent to Memory Stick PRO Duo media.
- This product cannot record or play data that uses “MagicGate” technology. “MagicGate” is a copyright protection technology that records and transfers the contents in an encrypted format.

About the “InfoLITHIUM” battery pack

Your camcorder operates only with an “InfoLITHIUM” V series battery pack of a large capacity, such as the NP-FV70A. “InfoLITHIUM” V series battery packs have the  mark.

What is an “InfoLITHIUM” battery pack?

An “InfoLITHIUM” battery pack is a lithium-ion battery pack that has functions for communicating information related to operating conditions between your camcorder and a supplied AC Adaptor. The “InfoLITHIUM” battery pack displays the remaining battery time in % according to the operating situations of your camcorder.





To use the battery pack effectively

- Battery pack performance decreases when the ambient temperature is 10 °C (50 °F) or below, and the length of time you can use the battery pack becomes shorter. In that case, do one of the following to use the battery pack for a longer time.
 - Put the battery pack in a pocket to warm it up, and install it in your camcorder right before you start taking shots.
- Make sure to turn off the camcorder when you are not recording or playing back. The battery pack is also consumed when your camcorder is in recording standby or playback pause.
- Have spare battery packs ready for 2 or 3 times the expected recording time, and make trial recordings before making the actual recording.
- Do not expose the battery pack to water. The battery pack is not water resistant.

About the remaining battery indicator

- Check the level with the following indicators and % displayed on the LCD screen.

Battery remaining indicator	%
	81% to 100%

Battery remaining indicator	%
	51% to 80%
	21% to 50%
	1% to 20%
	–

- The displayed level may not be correct under certain circumstances.
- When the power goes off even though the remaining battery percent indicator indicates that the battery pack has enough power to operate, charge the battery pack fully again. Remaining battery percent will be indicated correctly. Note, however, that the battery indication will not be restored if it is used in high temperatures for a long time, or if left in a fully charged state, or when the battery pack is frequently used. Use the remaining battery percent indication as a rough guide only.

About storage of the battery pack

- If the battery pack is not used for a long time, fully charge the battery pack and use it up on your camcorder once a year to maintain proper function. To store the battery pack, remove it from your camcorder and put it in a dry, cool place.
- To discharge the battery pack on your camcorder completely, leave your camcorder in recording standby until the power goes off.

About battery life

- The battery has a limited lifespan. Battery capacity decreases over time and through repeated use. If decreased usage time between charges becomes significant, it is probably time to replace it with a new one.
- Each battery's life is governed by storage, operating and environmental conditions.

About charging the battery pack

- Use the AC Adaptor (supplied) to charge the designated batteries only. If you charge other types of batteries, those batteries may leak, heat up, burst, or give an electric shock, resulting in burns or injury.
- Remove the charged battery from the AC Adaptor.

- The CHG lamp of the supplied AC Adaptor flashes in 2 patterns as follows:
Fast-flashing: Turns on and off rapidly at about 0.15-second intervals.
Slow-flashing: Turns on and off alternately for about 1.5 seconds, and turns off completely for about 1.5 seconds. The lamp repeats this sequence.
- If the CHG lamp is fast-flashing, remove the battery that is being charged, and then re-attach the same battery again firmly. If the CHG lamp continues fast-flashing, the cause could be that the battery is damaged, or the battery is not a designated type. Check the battery to confirm whether it is a designated type or not. If it is a designated type, remove the battery first, and then attach a brand-new battery or another known-to-be-good battery to see if the AC Adaptor is working correctly. If the AC Adaptor is working correctly, the cause could be that the battery is damaged.
- If the CHG lamp is slow-flashing, the AC Adaptor is in standby mode and charging is suspended. When the ambient temperature is out of the appropriate temperature range for charging, the AC Adaptor suspends charging automatically and enters standby mode. When the ambient temperature returns to an appropriate temperature, the AC Adaptor restarts charging and the CHG lamp lights up. We recommend charging the battery pack in an ambient temperature of from 10 °C to 30 °C (50 °F to 86 °F).

About handling of your camcorder

On use and care

- Do not use or store the camcorder and accessories in the following locations.
 - Anywhere extremely hot or cold.
Never leave them exposed to temperatures above 60 °C (140 °F), such as under direct sunlight, near heaters or in a car parked in the sun. They may malfunction or become deformed.
 - Near strong magnetic fields or mechanical vibration.
The camcorder may malfunction.
 - Near strong radio waves or radiation.
The camcorder may not be able to record properly.

Maintenance and precautions (Continued)

- Near AM receivers and video equipment. Noise may occur.
- On a sandy beach or anywhere dusty. If sand or dust gets in your camcorder, the camcorder may malfunction. Sometimes this malfunction cannot be repaired.
- Near windows or outdoors, where the LCD screen, the viewfinder, or the lens may be exposed to direct sunlight. This damages the inside of the viewfinder or the LCD screen.
- Anywhere very humid.
- Operate your camcorder on 7.3 V (battery pack) or 8.4 V DC (AC Adaptor).
- For DC or AC operation, use the accessories recommended in these operating instructions.
- Do not let your camcorder get wet, for example, from rain or sea water. If your camcorder gets wet, it may malfunction. Sometimes this malfunction cannot be repaired.
- If any solid object or liquid gets inside the casing, unplug your camcorder and have it checked by a Sony dealer before operating it any further.
- Avoid rough handling, disassembling, modifying, physical shock, or impact such as hammering, dropping or stepping on the product. Be particularly careful of the lens.
- Do not use a deformed or damaged battery pack.
- Keep the  (On/Standby) button set to the standby position when you are not using your camcorder.
- Do not wrap your camcorder with a towel, for example, and operate it. Doing so might cause heat to build up inside.
- When disconnecting the power cord (mains lead), pull it by the plug and not the lead.
- Do not damage the power cord (mains lead) such as by placing anything heavy on it.
- Keep metal contacts clean.
- Keep the Wireless Remote Commander and button-type battery out of children's reach. If the battery is accidentally swallowed, consult a doctor immediately.
- If the battery electrolytic liquid has leaked,
 - consult your local authorized Sony service facility.
 - wash off any liquid that may have contacted your skin.
 - if any liquid gets in your eyes, wash with plenty of water and consult a doctor.

■ When not using your camcorder for a long time

- Turn on the camcorder and record and play back images about once a month to keep it in an optimum state for a long time.
- Use up the battery pack completely before storing it.

Moisture condensation

If your camcorder is brought directly from a cold place to a warm place, moisture may condense inside your camcorder and cause a malfunction of your camcorder.

■ If moisture condensation has occurred

Leave your camcorder for about 1 hour without turning it on.

■ Note on moisture condensation

Moisture may condense when you bring your camcorder from a cold place into a warm place (or vice versa) or when you use your camcorder in a humid place as shown below.

- When you bring your camcorder from a ski slope into a place warmed up by a heating device.
- When you bring your camcorder from an air conditioned car or room into a hot place outside.
- When you use your camcorder after a squall or a shower.
- When you use your camcorder in a hot and humid place.

■ How to avoid moisture condensation

When you bring your camcorder from a cold place into a warm place, put your camcorder in a plastic bag and seal it tightly. Remove the bag when the air temperature inside the plastic bag has reached the ambient temperature (after about 1 hour).

LCD screen

- Do not exert excessive pressure on the LCD screen, as it may cause damage.
- If your camcorder is used in a cold place, a residual image may appear on the LCD screen. This is not a malfunction.
- While using your camcorder, the back of the LCD screen may heat up. This is not a malfunction.

■ To clean the LCD screen

The LCD screen is covered with a coating. The coating may be peeled off by scratching or rubbing. Maintain the LCD screen as follows.

- Wipe fingerprints or hand cream off the LCD screen as soon as possible, as they may cause the coating to peel off.
- If you rub the LCD screen hard, even with a tissue, the coating may be damaged.
- Before wiping the LCD screen, blow dust or sand off with a dust blower, etc.
- Wipe dirt off the LCD screen with a clean, soft cloth, such as an eye glass cleaning cloth, etc.

■ To adjust the touch panel (CALIBRATION)

The buttons on the touch panel may not work correctly.

If this happens, follow the procedure below. It is recommended that you connect your camcorder to the wall outlet (wall socket) using the supplied AC Adaptor during the operation.

- ① Press the MENU button → select  (OTHERS) → [CALIBRATION] with the ▲/▼/◀/▶/SET button.
- ② Touch “x” displayed on the LCD screen with the corner of memory card or the like 3 times.



🔊 Notes

- If you did not press the right spot, try the calibration again.
- Do not use a sharp-pointed object for calibration. Doing so may damage the LCD screen.
- You cannot perform the calibration when the LCD screen is turned around, or facing up and closed to the camcorder

■ OLED panel display

The OLED panel may experience issues such as screen burn-in or loss of brightness with normal use over time.

This is not a malfunction.

Casing

- If the casing is soiled, clean the camcorder body with a soft cloth lightly moistened with water, and then wipe the casing with a dry soft cloth.
- Avoid the following to prevent damage to the finish.
 - Using chemicals such as thinner, benzene, alcohol, chemical cloths, repellent, insecticide and sunscreen.
 - Handling with above substances on your hands.
 - Leaving the casing in contact with rubber or vinyl objects for a long period of time.

Care and storage of the lens

- Wipe the surface of the lens clean with a soft cloth in the following instances: when there are fingerprints on the lens surface, in hot or humid locations, and when the lens is exposed to salty air such as at the seaside.
- Store in a well-ventilated location subject to little dirt or dust.
- To prevent mold, periodically clean the lens as described above.

Charging the pre-installed rechargeable battery

Your camcorder has a pre-installed rechargeable battery to retain the date, time, and other settings even when the ⏻ (On/Standby) button is set to the standby position. The pre-installed rechargeable battery is always charged while your camcorder is connected to the wall outlet (wall socket) via the AC Adaptor or while the battery pack is attached. The rechargeable battery will be fully discharged in about **3 months** if you do not use your camcorder at all, with the AC Adaptor not connected or battery pack not attached. Use your camcorder after charging the pre-installed rechargeable battery.

However, even if the pre-installed rechargeable battery is not charged, the camcorder operation will not be affected as long as you are not recording the date.

Maintenance and precautions (Continued)

■ Charging procedure

Connect your camcorder to a wall outlet (wall socket) using the supplied AC Adaptor, and leave it with the power turned off for more than 24 hours.

Note on disposal/transfer of memory cards

Even if you delete data in a memory card or format the memory card on your camcorder or a computer, you may not delete data from the memory card completely. When you give the memory card to somebody, it is recommended that you delete data completely using data deletion software on a computer. Also, when you dispose of the memory card, it is recommended that you destroy the actual body of the memory card. Operation is not guaranteed when using a card adaptor.

Specifications

General

Power requirements

8.4 V DC (using AC Adaptor)

7.4 V DC (using battery pack)

Power consumption

While recording using viewfinder:

Approx. 5.7 W

While recording using the LCD screen in normal brightness:

Approx. 6.1 W

Operating temperature

0 °C to 40 °C (32 °F to 104 °F)

Storage temperature

-20 °C to +60 °C (-4 °F to +140 °F)

Dimensions

Approx. 121.0 mm × 104.0 mm × 274.5 mm (4 ⁷/₈ in × 4 ¹/₈ in × 10 ⁷/₈ in.)

(Including projecting parts, lens hood, large eyecup, battery (NP-FV70A).

Excluding grip belt.) (width / height / depth)

Approx. 130.0 mm × 181.5 mm ×

287.0 mm (5 ¹/₈ in × 7 ¹/₄ in ×

11 ³/₈ in.) (Including projecting parts,

lens hood, large eyecup, battery (NP-FV70A), XLR handle unit.

Excluding grip belt.) (width / height / depth)

Dimensions when shooting

Approx. 130.0 mm × 181.5 mm ×

287.0 mm (5 ¹/₈ in. × 7 ¹/₄ in. ×

11 ³/₈ in.) (Including projecting parts)

Mass

Approx. 955 g (2 lb 1.7 oz) (Including lens hood, large eyecup)

Total mass when shooting

Approx. 1320 g (2 lb 14.6 oz)

(Including lens hood, large eyecup, NP-FV70A battery, XLR handle unit)

System

Signal format

When [60i] is selected:

NTSC color, EIA standards

HDTV 1080/60i, 1080/60p, 720/60p

When [50i] is selected

PAL color, CCIR standards HDTV

1080/50i, 1080/50p, 720/50p

Video recording system

XAVC S: MPEG-4 AVC/H.264 4:2:0

Long profile

XAVC S Proxy: MPEG-4 AVC/H.264

4:2:0 Long profile

AVCHD: MPEG-4 AVC/H.264

AVCHD 2.0 format compatible

Audio recording format

XAVC S: Linear PCM 2ch, 16-bit, 48 kHz

XAVC S Proxy: AAC-LC 2-ch, 16-bit, 48 kHz

AVCHD: Linear PCM 2-ch, 16-bit, 48 kHz/Dolby Digital 2-ch, 16-bit, 48 kHz

Recording media (movies)

Memory Stick PRO Duo™ and SD cards

Camera

Imaging device

1.0-inch type Exmor RS™ CMOS sensor

Total picture elements: Approx.

21,000,000 pixels

Effective picture elements (16:9 mode):

Approx. 14,200,000 pixels

Color temperature

Preset (Indoor: 3200K, Outdoor: 5600K ± 7 steps, Color temperature set range: 2300 to 15000K), One-push A, B, Auto selectable

Specifications (Continued)

Minimum illumination

- When [60i] is selected:
1.7 lux (LOW LUX mode is on,
1/30 sec. shutter speed, 33 dB gain)
When [50i] is selected:
1.7 lux (LOW LUX mode is on,
1/25 sec. shutter speed, 33 dB gain)

Lens

Lens mount

Fixed

Zoom ratio

12× (optical), servo

Focal length

9.3 mm to 111.6 mm
(35 mm equivalent (16:9)
29.0 mm to 348.0 mm
(35 mm equivalent (3:2)
32.8 mm to 393.6 mm)

Iris

F2.8 to F4.5
(auto/manual selectable)

Focus

AF/MF selectable,
10 mm to ∞ (Wide),
1000 mm to ∞ (Tele)

Image stabilizer

On/Off selectable, lens-shift type

Filter diameter

M62 mm

Wireless LAN

Supported standard

IEEE 802.11 b/g/n

Frequency band

2.4 GHz

Supported security protocols

WEP/WPA-PSK/
WPA2-PSK
NFC Forum Type 3 Tag compliant

Input/output connectors

VIDEO OUT jack

Multi/Micro USB jack (1)
Composite 1.0 Vp-p, 75 Ω

AUDIO OUT jack

Multi/Micro USB jack (1)

HDMI OUT jack

Type A (1)

USB jack

Multi/Micro USB jack (1)

📶 (headphone) jack

Stereo mini jack (Ø3.5 mm) (1)

INPUT1/INPUT2 jacks

XL R-type 3-pin (female) (2)
line/mic/mic+48V selectable

MIC jack (PLUG IN POWER)

Stereo mini jack (Ø3.5 mm) (1)

Multi Interface Shoe (1)

REMOTE jack

Stereo sub-mini jack (Ø2.5 mm) (1)

Screen

LCD screen

8.8 cm (3.5 inch type)
Approx. 1.56M dots

Viewfinder

1.0 cm (0.39 inch type) OLED
Approx. 2.36M dots

Rechargeable battery pack (NP-FV70A)

Rated voltage

7.3 V DC

AC Adaptor

Power requirements

100 V to 240 V AC, 50 Hz/60 Hz

Power consumption

18 W

Rated output

8.4 V DC*1

Operating temperature

0 °C to 40 °C (32 °F to 104 °F)

Storage temperature

-20 °C to +60 °C (-4 °F to +140 °F)

Dimensions

Approx. 48 mm × 29 mm × 81 mm

(1 ¹⁵/₁₆ in. × 1 ³/₁₆ in. × 3 ¹/₄ in.)

(Excluding projecting parts)

(width / height / depth)

Mass (body only)

Approx. 170 g (6.0 oz)

*1 Check the label on the AC Adaptor/charger for other specifications.

Index

A

AC Adaptor 19
Access point 77
Accessory shoe 23
AE SHIFT 140
AGC LIMIT 103
AIRPLANE MODE 124
AREA SET 125
ASPECT 119
ASSIGN BUTTON 125
ASSIGN buttons 64
AUDIO LEVEL
DISPLAY 120
AUDIO SET menu 116
AUTO BACK LIGHT 110
AUTO/MANUAL switch 53
Auto mode 53
AUTO MODE SET 109
AVCHD 157
AVCHD AUDIO
FORMAT 116

B

Battery 21
BEEP 126
Button-type lithium
battery 16

C

CALIBRATION 161
CAMERA DATA
DISPLAY 120
CAMERA PROFILE 125
CAMERA SET menu 103
CENTER 119
Charging time 22
CHG lamp 21
CLOCK SET 24
COLOR BAR 140
Connect
tv or monitor 69

Content Browser Mobile 74

CTRL W/
SMARTPHONE 123

D

DATA CODE 67
Date and time 18, 24, 25
DATE REC 126
DELETE 97
Direct Menu 48
DISPLAY button 67
DISPLAY OUTPUT 122
DISPLAY SET menu 118
DIVIDE 96
DOWN CONVERT
TYPE 114
Drop frame 122

E

EDIT menu 127
Error messages 146

F

FACE DETECTION 39
File format
limitations 151
Focus 35
FOCUS DISPLAY 120
FOCUS MAG RATIO 119
Focus Magnifier 38
FOCUS MAGNIFIER
button 38
Focus ring 35
Format media 98
Function limitations 151

G

Gain 44
Getting started 19
GUIDEFRAAME 119

H

Handle record button 32
Handle zoom 33
Handle zoom lever 33
HISTOGRAM 118

I

Image database file 99
INDOOR 46
“InfoLITHIUM”
battery pack 158
INITIALIZE 127
Iris 43
IRIS button 43
Iris ring 43
ISO/GAIN button 44

L

LANGUAGE 125
Large eyecup 26
Last Scene Review 62
LCD BRIGHT 121
LCD screen 26
Lens 12, 161
LOW LUX 54

M

MANU WB TEMP 46
MARKER 140
Maximum recording time 149
MEDIA FORMAT 98
Memory card
file/folder structure 156
formatting 98
inserting/ejecting 29
notes 157
supported
memory cards 27
“Memory Stick”
media 27, 158

“Memory Stick PRO Duo” media	158
Menu	100
AUDIO SET	116
CAMERA SET	103
DISPLAY SET	118
EDIT	127
items	101
NETWORK SET	123
OTHERS	125
REC/OUT SET	111
TC/UB SET	122
MENU button	100
MIC+48V	50
Microphone	
internal	50
Multi Interface Shoe	51
Moisture condensation	160
Multi Interface Shoe	8
Multi/Micro USB jack	8
N	
ND filter switch	45
Network functions	74
NETWORK RESET	124
NETWORK SET menu	123
NFC	75
O	
OPERATION TIME	126
OTHERS menu	125
OUTDOOR	46
Output signal formats	70
P	
PEAKING	140
PICTURE PROFILE	54
Playback	65
Power cord	21
Power outlet	22
Power zoom lever	33

Pre-installed rechargeable battery	161
PROTECT	96
Proxy recording supported formats	154

R

REC BUTTON SET	32
REC LAMP	126
REC/OUT SET menu	111
REC SET	111
Rechargeable battery pack, see Battery Recording	30
Recording format	41
Recording lamp	126
Recording time	149
Relay recording	31
REMOTE CONTROL	126
Remote control	16
REPAIR IMAGE DB FILE	99
Reviewing	62
ROOT CERTIFICATE	124
Root certificate	94
RTMP/RTMPS	123

S

S&Q MOTION	59
SAFETY ZONE	119
SCENE SELECTION SET	53
Screen indicators	17, 67
Self-diagnosis display	144
Shooting	30
SHUTTER button	44
SHUTTER DISPLAY	120
Shutter speed	44
SIMUL/RELAY REC	32
Simultaneous recording	32
Slow & Quick Motion	59
limitations	152

Smartphone	74
Specifications	163
SPOT FOCUS	39
START/STOP button	30
STATUS button	68
Status check	68
STEADYSHOT	104
STREAMING	83, 124
Streaming	83
supported formats	153
SUMMERTIME	125
Supplied accessories	19

T

TC FORMAT	122
TC MAKE	123
TC PRESET	58, 140
TC RUN	123
TC/UB SET menu	122
Telephoto	33
Trademarks	169
Troubleshooting	136
TV	69

U

UB PRESET	59
UB TIME REC	123
USB CONNECT	126
USB LUN SET	126
Using your camcorder abroad	155
USTREAM	89

V

VERSION DISPLAY	127
VF COLOR TEMP	121
VIDEO OUT	113
Viewfinder	26
diopter adjustment dial	26
VOLUME	66

Index (Continued)



W

Warning indicators	144
Warning messages	145
WB OUTDOOR LEVEL ...	103
WB PRESET	103
WB TEMP SET	103
White balance	46
WHITE BALANCE button	46
Wi-Fi SET	124
Wide angle	33
Wired LAN	82
WIRED LAN SET	124
Wireless LAN	77

Z

ZEBRA	140
Zoom	33
ZOOM DISPLAY	120
ZOOM SET	104

Trademarks

- “NXCAM” logo is a trademark of Sony Corporation.
- “XAVC S” and  are registered trademarks of Sony Corporation.
- “AVCHD” and the “AVCHD” logo are trademarks of Panasonic Corporation and Sony Corporation.
- “Memory Stick,”  “Memory Stick Duo,” “Memory Stick PRO Duo,” “Memory Stick PRO-HG Duo,” “MagicGate,” “MagicGate Memory Stick,” “MagicGate Memory Stick Duo,” “Content Browser Mobile,” and “Content Browser Mobile” logo are trademarks or registered trademarks of Sony Corporation.
- “InfoLITHIUM” is a trademark of Sony Corporation.
- “BRAVIA” is a trademark of Sony Corporation.
- Dolby and the double-D symbol are trademarks of Dolby Laboratories.
- The terms HDMI and HDMI High-Definition Multimedia Interface, and the HDMI Logo are trademarks or registered trademarks of HDMI Licensing, LLC in the United States and other countries.
- SDXC logo is a trademark of SD-3C, LLC.
- iPad is a trademark of Apple Inc., registered in the U.S. and other countries.
- IOS is a registered trademark or trademark of Cisco Systems, Inc. and/or its affiliates in the United States and certain other countries.
- iPhone is a trademark of Apple Inc., registered in the U.S. and other countries. The iPhone trademark is used under license from iPhone Co., Ltd.
- Android, Google Play are trademarks of Google Inc.
- Wi-Fi, the Wi-Fi logo, Wi-Fi PROTECTED SET-UP are registered trademarks of the Wi-Fi Alliance.
- The N Mark is a trademark or registered trademark of NFC Forum, Inc. in the United States and in other countries.

All other product names and brand names are registered trademarks or trademarks of their respective owners. Trademarked items are not indicated by ® or ™ symbols in this manual.

Notes on the License

THIS PRODUCT IS LICENSED UNDER THE AVC PATENT PORTFOLIO LICENSE FOR THE PERSONAL USE OF A CONSUMER OR OTHER USES IN WHICH IT DOES NOT RECEIVE REMUNERATION

(i) ENCODE VIDEO IN COMPLIANCE WITH THE AVC STANDARD (“AVC VIDEO”) AND/OR

(ii) DECODE AVC VIDEO THAT WAS ENCODED BY A CONSUMER ENGAGED IN A PERSONAL ACTIVITY AND/OR WAS OBTAINED FROM A VIDEO PROVIDER LICENSED TO PROVIDE AVC VIDEO. NO LICENSE IS GRANTED OR SHALL BE IMPLIED FOR ANY OTHER USE. ADDITIONAL INFORMATION MAY BE OBTAINED FROM MPEG LA, L.L.C. SEE <[HTTP://WWW.MPEGLA.COM](http://www.mpegla.com)>

Software is installed in your camcorder. We provide this software based on the license agreements of the copyright owners. Based on requests by the owners of copyright of these software applications, we have an obligation to inform you of the following.

Licenses (in English) are recorded in the internal memory of your camera. Establish a Mass Storage connection between the camera and a computer to read licenses in the “PMHOME” → “LICENSE” folder.

On GNU GPL/LGPL applied software

The software that is eligible for the following GNU General Public License (hereinafter referred to as “GPL”) or GNU Lesser General Public License (hereinafter referred to as “LGPL”) are included in the camcorder.

This informs you that you have a right to have access to, modify, and redistribute source code for these software programs under the conditions of the supplied GPL/LGPL.

Source code is provided on the web. Use the following URL to download it.
<http://oss.sony.net/Products/Linux/>

We would prefer you do not contact us about the contents of source code.

Licenses (in English) are recorded in the internal memory of your camera.

Establish a Mass Storage connection between the camera and a computer to read licenses in the "PMHOME" - "LICENSE" folder.

<http://www.sony.net/>

© 2017 Sony Corporation

Printed in China



4731568130