



ATW-C710

User Manual
Interchangeable Microphone Capsule

audio-technica

Thank you for purchasing this product. Before using the product, read through the user manual to ensure that you will use the product correctly. Please keep this manual for future reference.

Safety precautions

Although this product was designed to be used safely, failing to use it correctly may result in an accident. To ensure safety, observe all warnings and cautions while using the product.

Cautions for the product

- Do not subject the product to strong impact to avoid malfunction.
- Do not disassemble, modify or attempt to repair the product.
- Do not handle the product with wet hands to avoid electric shock or injury.
- Do not store the product under direct sunlight, near heating devices or in a hot, humid or dusty place.

Notes on use

- Do not directly touch or scratch the contact surface.
- When installing/removing the product, be sure to turn the power of the transmitter.
- When installing the product, do not forcibly install the product with strong force. The product may be damaged.

Installing/removing the product

How to install

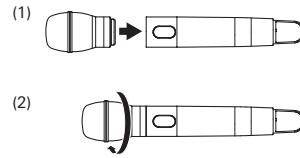

How to remove

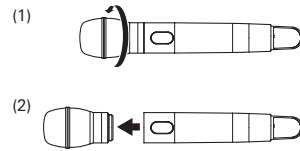

Specifications

Element	Fixed-charge back plate, permanently polarized condenser
Polar pattern	Cardioid
Weight	114 g (4.0 oz)

For product improvement, the product is subject to modification without notice.

Polar pattern

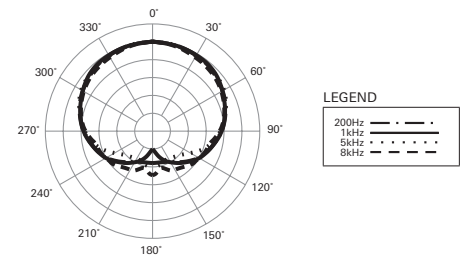

SCALE IS 5 DECIBELS PER DIVISION

Dimensions

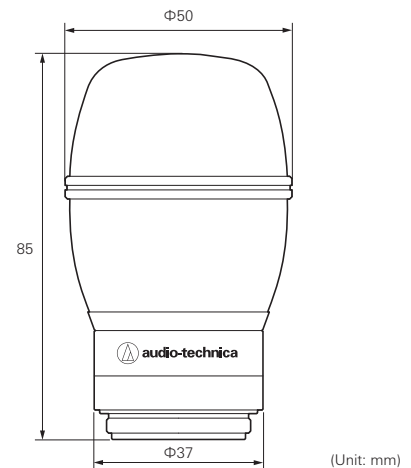

(Unit: mm)

Warranty (Please be sure to read the notes below.) For USA Only

End-User LIMITED WARRANTY information for the USA is available at www.audio-technica.com/usawarranties. You may also contact Audio-Technica U.S., Inc. to request a written copy of the Limited Warranty at 1-330-686-2600 or via mail at 1221 Commerce Drive, Stow, OH 44224.