



Instruction Manual

AT2005USB
Cardioid Dynamic USB/XLR Microphone

Contents

Introduction & features	3
Setting up your microphone with stand clamp & desk stand	4
Preliminary setup with Mac OS X	5
Preliminary setup with Windows XP	6
Preliminary setup with Windows Vista	9
Preliminary setup with Windows 7	10
Using headphones	13
Selecting software	13
Setting your software levels	13
Positioning your microphone	13
XLR operation	13
Protecting your microphone	13
Specifications	14

Compliance with FCC rules (USA only)

This device complies with Part 15 of the FCC rules. Operation is subject to the following two conditions:(1) this device may not cause harmful interference, and (2) this device must accept any interference received, including interference that may cause undesired operation.

FCC WARNING

You are cautioned that any changes or modifications not expressly approved in this manual could void your authority to operate this equipment.

Canada only

This Class B digital apparatus complies with Canadian ICES-003.

Cet appareil numérique de la classe B est conforme á la norme NMB -003 du Canada.

Federal Communications Commission Statement

Note: This equipment has been tested and found to comply with the limits for a Class B digital device, pursuant to part 15 of the FCC Rules. These limits are designed to provide reasonable protection against harmful interference in a residential installation. This equipment generates, uses and can radiate radio frequency energy and, if not installed and used in accordance with the instructions, may cause harmful interference to radio communications. However, there is no guarantee that interference will not occur in a particular installation. If this equipment does cause harmful interference to radio or television reception, which can be determined by turning the equipment off and on, the user is encouraged to try to correct the interference by one or more of the following measures:

- Reorient or relocate the receiving antenna.
- Increase the separation between the equipment and receiver.
- Connect the equipment into an outlet on a circuit different from that to which the receiver is connected.
- Consult the dealer or an experienced radio/TV technician for help.

Thank you for buying the Audio-Technica AT2005USB cardioid dynamic USB/XLR microphone. Equipped with both USB and an XLR outputs, this digital/analog mic is designed both for live performance and digitally capturing music or any acoustic audio source using your favorite recording software.

The AT2005USB offers high-quality articulation and intelligibility perfect for home studio recording, field recording, podcasting, voiceover, and on-stage use. Its cardioid polar pattern reduces pickup of sounds from the sides and rear, improving isolation of desired sound source.

The microphone also features a built-in headphone jack with volume control that allows you to directly monitor from your microphone. The microphone's focused pickup pattern delivers excellent off-axis rejection, while its A/D converter with a 16-bit, 44.1/48 kHz sampling rate ensures clear, articulate sound reproduction.

Audio-Technica's state-of-the-art design and manufacturing techniques ensure that the microphone complies with the company's renowned consistency and reliability standards.

Features

- Handheld dynamic microphone with USB digital output and XLR analog output
- USB output connects to your computer for digital recording, while the XLR output connects with your sound system's conventional microphone input for use in live performance
- Smooth, extended frequency response ideally suited for podcasting, home studio recording, field recording, voiceover, and on-stage use
- Built-in headphone jack allows you to directly monitor from your microphone
- Adjust headphone volume with easy-to-use controls on the bottom of the microphone
- High-quality A/D converter with 16-bit, 44.1/48 kHz sampling rate
- Compatible with Windows and Mac
- Low-mass diaphragm provides excellent frequency response
- Cardioid polar pattern reduces pickup of sounds from the sides and rear, improving isolation of desired sound source
- Tripod desk stand with folding legs for secure and easily portable tabletop use
- Pivoting, threaded stand clamp attaches securely to the supplied tripod or to a conventional microphone stand
- USB and XLR cables included
- Durable metal construction for long-lasting performance
- On/off switch functions for both USB and analog operation

AT2005USB

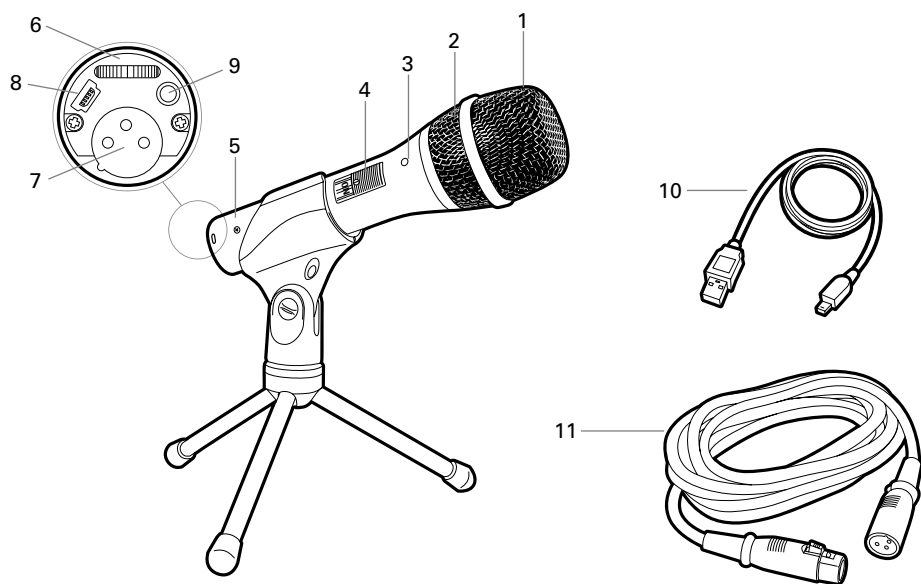

- 1. Windscreen**—Multi-stage grille design offers excellent protection against plosives and sibilance without compromising high-frequency clarity
- 2. Capsule**—Dynamic microphone element with cardioid polar pattern
- 3. Blue LED**—Blue light shows mic is receiving USB power (**Note:** The blue LED is not affected by the on/off switch position)
- 4. ON/OFF switch**—Functions for both USB and analog operation
- 5. Metal construction**—Tough, durable, resilient design
- 6. Headphone level control**—Up/Down dial controls headphone volume
- 7. XLR connector**—XLR connector with analog output for connection to PA system's conventional microphone input
- 8. USB**—USB connector for connection to your Mac or PC
- 9. Headphone Jack**— $\frac{1}{8}$ -inch (3.5 mm) stereo jack for connecting your headphones
- 10. USB cable**
- 11. XLRM to XLRF cable**

Setting up your microphone with included stand clamp and tripod desk stand

- Screw the stand clamp onto the threaded portion of the desk stand.
- Extend the tripod legs to provide a wide, secure base, and place the tripod desk stand on a flat surface.
- Install the AT2005USB microphone into the microphone mount, with ON/OFF switch up
- The top of the microphone should be facing the sound source.
- Use a screwdriver or coin to loosen and tighten the pivot screw for angle adjustment.
- Plug the provided USB cable into the USB output at the base of the microphone, or plug the provided XLR cable into the microphone input of your sound system.

Note: Many recording software programs are available online. Audacity is widely used free software for recording and editing sounds. It is available online at <http://audacity.sourceforge.net/>

Preliminary setup with Mac OS X

1. Plug the free end of the provided USB cable into the USB port on your computer. The microphone's blue LED will illuminate, indicating the microphone is receiving power. Your computer will automatically recognize the USB device and install a driver.
2. To select the AT2005USB as your audio input, first, open your **System Preferences**.

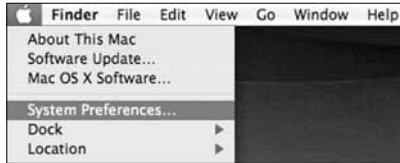

3. Next, click Sound to display the **Sound** preference pane.



4. Click the **Input** tab and select the **AT2005USB** as the device for sound input.

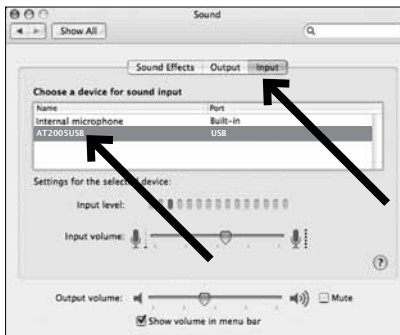

Your preferences are now set to use the AT2005USB on your Mac with GarageBand or another recording program of your choice.

Preliminary setup with Windows XP

(Service Pack 2; other operating systems may vary slightly)

1. Plug the free end of the USB cable into the USB port on your computer. The microphone's blue LED will illuminate, indicating the mic is receiving power. Your computer will automatically recognize the USB device and install a driver.
2. In the lower right portion of your screen you may see a message that new hardware was found; or you may see a driver software installation notice.
3. To select the AT2005USB as your default recording device, begin at your **Start** menu. Select **Control Panel**.



4. Select Sounds and Audio Devices.

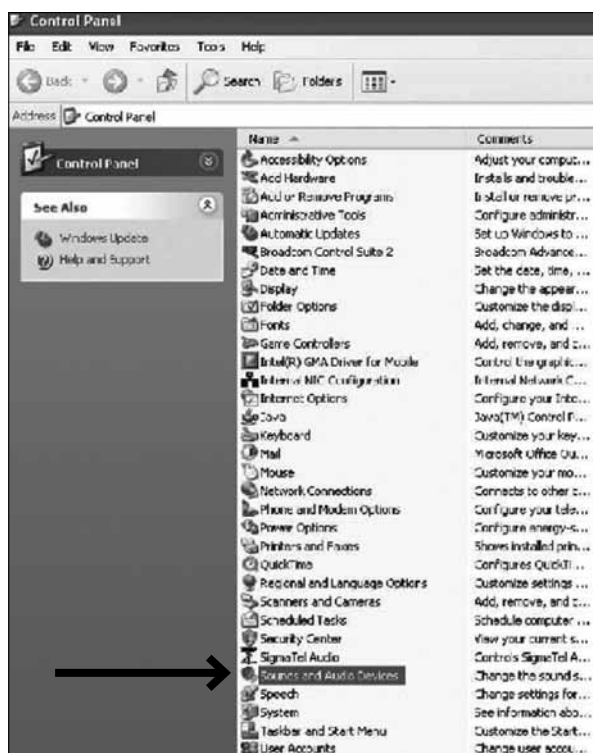

Preliminary setup with Windows XP (continued)

5. Select the **Audio** tab, and choose **AT2005USB** as the default device.
6. Adjust computer volume by clicking on the **Volume** button beneath Sound recording Default device.

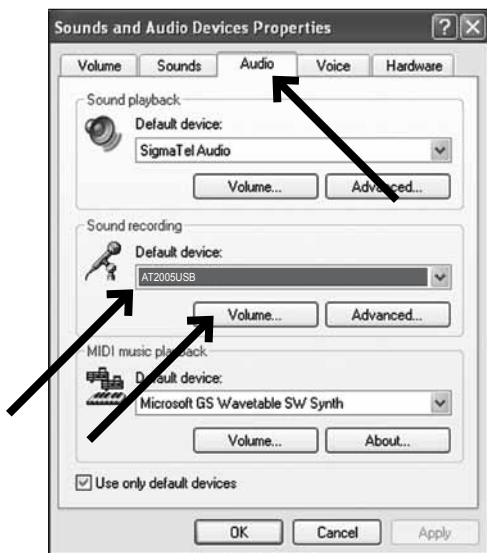

7. Through the **Wave In** window, you can set the computer volume or mute the microphone.

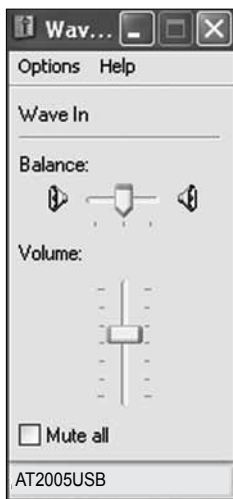

Your preferences are now set to use the AT2005USB with Windows XP with the recording program of your choice.

Preliminary setup with Windows Vista

1. Plug the free end of the USB cable into the USB port on your computer. The microphone's blue LED will illuminate, indicating the mic is receiving power. Your computer will automatically recognize the USB device and install a driver.
2. In the lower right portion of your screen you may see a message that new hardware was found; or you may see a driver software installation notice.
3. To select the AT2005USB as your default recording device, begin at your **Start** menu. Select **Control Panel**.
4. Select (double-click) **Sound**.



5. Select the **Recording** tab. Make sure that the **AT2005USB** microphone is set as the default recording device. (You should see a green check mark beside the USB microphone icon.)

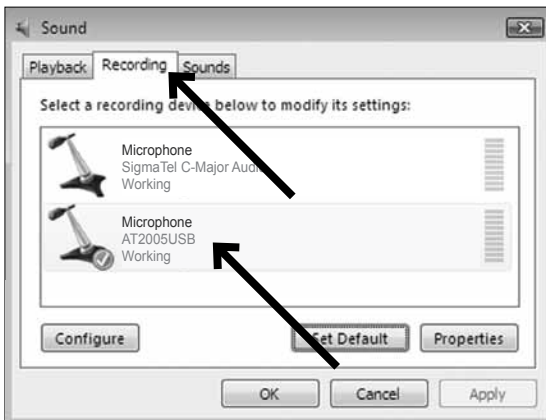

Your preferences are now set to use the AT2005USB with Windows Vista with the recording program of your choice.

Preliminary setup with Windows 7

1. Plug the free end of the USB cable into the USB port on your computer. The microphone's blue LED light will illuminate, indicating the mic is receiving power. Your computer will automatically recognize the USB device and install a driver.
2. In the lower right portion of your screen you may get a message that new hardware was found; or you may see a driver software installation notice.
3. **Start menu > Control Panel > Sound**
To select the AT2005USB as your default recording device, begin at your Start menu. Select **Control Panel**.

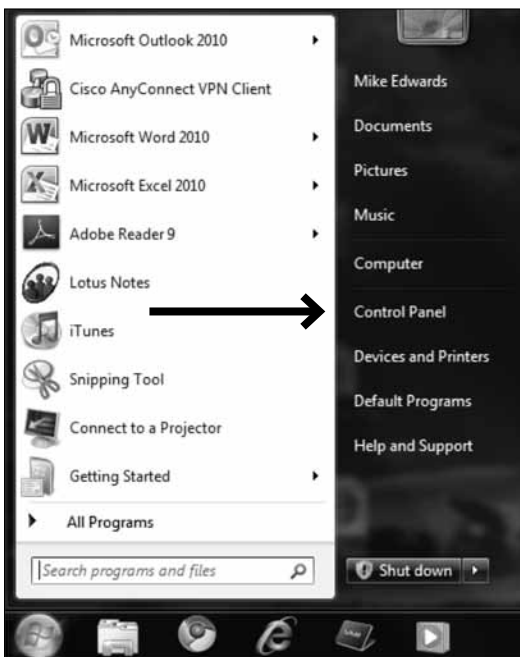

4. Select **Sound**.

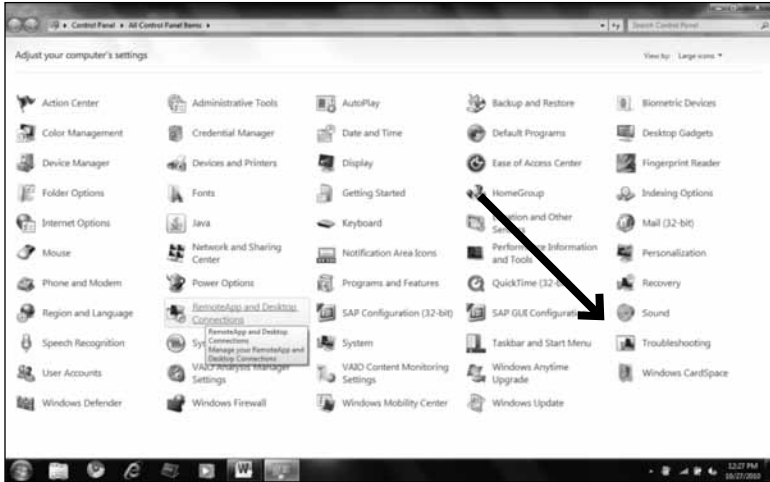

5. The following screen will pop up:



Preliminary setup with Windows 7 (continued)

6. Select the **Recording** tab, and choose **AT2005USB** as the default device.

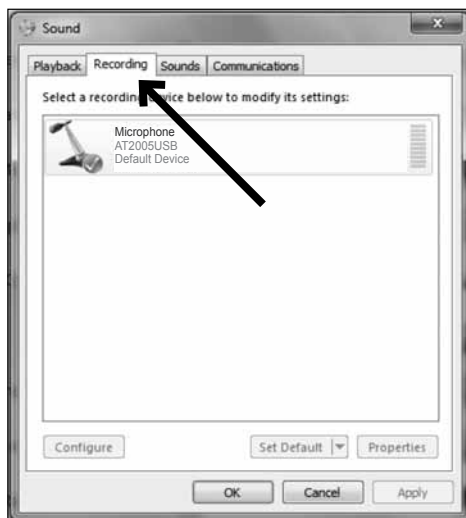

7. Double click on the AT2005USB icon to open the **Microphone Properties** window. Select the levels tab to adjust microphone level (loudness). You may need to come back to this window to readjust the level after you begin recording.

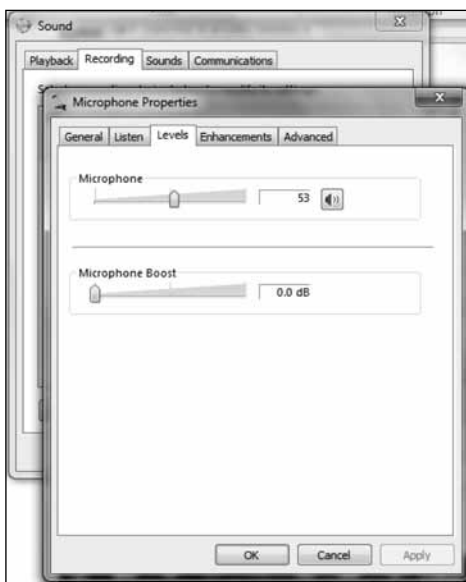

Your preferences are now set to use the AT2005USB with Windows 7 with the recording program of your choice.

Using headphones

The $\frac{1}{8}$ " (3.5 mm) headphone jack on the bottom of the microphone allows you to directly monitor your recording with a pair of headphones. When your preliminary setup is completed, and your USB microphone is connected to your computer's USB port (the microphone's blue LED is illuminated), plug your headphones into the headphone jack on the bottom of the microphone. While talking into the microphone, you should hear yourself in the headphones. Adjust the volume up or down by rotating the the Up/ Down dial on the bottom of the microphone. **Note:** The Up/ Down dial only adjusts the volume of the mic's headphone output; it does not adjust the microphone level.

Selecting software

You have many choices in recording software. Audacity, available for free online at <http://audacity.sourceforge.net/>, is a widely used software program that provides basic recording software.

Setting your software levels

Correct adjustment of microphone level is important for optimum performance. Ideally, the microphone level should be as high as possible without overloading the input of your computer. If you hear distortion, or if your recording program shows levels that are consistently overloaded (at peak levels), turn the microphone volume (or level) down, either through your control panel (or system preferences) settings, or through your recording software. If your recording program shows insufficient level, you can increase the microphone gain either from the control panel (or system preferences) settings or through your recording program.

No further microphone level adjustments should be needed, as long as the acoustic input does not change significantly.

Positioning your microphone

It is important to position the microphone directly in line (on axis) with the person speaking/singing or instrument (or other sound source) to achieve the best frequency response of the microphone.

For use in speaking/singing applications, the ideal placement for the microphone is directly in front of the person speaking/singing. The same placement is optimal when miking an instrument such as an acoustic guitar, drums or piano. Experiment with different mic placements to find the best sound for your particular setup.

XLR operation

For live-sound applications, connect the XLR connector of the included XLR cable to the XLRM output on the bottom of the microphone; connect the cable's XLRM connector to a standard XLRF microphone input on your mixer. Turn the microphone's ON/OFF switch to the "ON" position. Set the microphone's level by following the instructions included with your mixer. **Note:** The ON/OFF switch does not affect the LED.

Protecting your microphone

Take care to keep foreign particles from entering the windscreen. An accumulation of iron or steel filings on the diaphragm, and/or foreign material in the windscreen's mesh surface, can degrade performance.

AT2005USB Specifications†

Element: Dynamic

Polar Pattern: Cardioid

Frequency Response: 50 – 15,000 Hz

Power Requirements: USB Power (5V DC)

Bit Depth: 16 bit

Sample Rate: 44.1 kHz/48 kHz

Controls: On/off switch; headphone volume control

Weight: 266 g (9.4 oz)

Dimensions: 183.6 mm (7.23") long, 51.0 mm (2.01") maximum body diameter

Output Connector: USB-type/XLR-type

Headphone Output Power: 10 mW @ 16 ohms

Headphone Jack: 3.5 mm TRS (stereo)

Accessories Included: Stand clamp for $\frac{5}{8}$ "-27 threaded stands, tripod desk stand, 2 m (6.6') mini USB cable, 3 m (9.8') XLR-type to XLRM-type cable

System Requirements: Macintosh: MAC OS X; USB 1.0 or 2.0; 64 MB RAM (minimum)

Windows: XP/Vista/Windows 7; USB 1.0 or 2.0; 64 MB RAM (minimum)

†In the interest of standards development, A.T.U.S. offers full details on its test methods to other industry professionals on request. Specifications are subject to change without notice.

Frequency Response

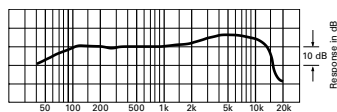

LEGEND — 12" or more on axis

Polar Pattern

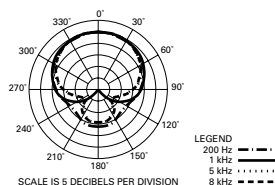

AT2005USB

To reduce the environmental impact of a multi-language printed document, product information is available online at www.audio-technica.com in a selection of languages.

Afin de réduire l'impact sur l'environnement de l'impression de plusieurs, les informations concernant les produits sont disponibles sur le site www.audio-technica.com dans une large sélection de langue.

Para reducir el impacto al medioambiente, y reducir la producción de documentos en varios leguajes, información de nuestros productos están disponibles en nuestra página del Internet: www.audio-technica.com.



Audio-Technica U.S., Inc.
1221 Commerce Drive, Stow, Ohio 44224 USA +1 (330) 686-2600

©2012 Audio-Technica U.S., Inc. P52364-01

