

# Panasonic®

## Operating Instructions **Vol.1**

### Memory Card Camera-Recorder

Model No. **AG-DVX200PJ**  
**AG-DVX200PB**  
**AG-DVX200PX**

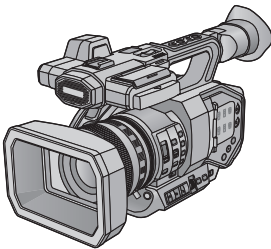

## **Vol.1**

### **Please read first**

For more information, please visit the Panasonic website (<https://pro-av.panasonic.net/manual/en/index.html>), and refer to the Operating Instruction Vol.2.

Please read these instructions carefully before using this product, and save this manual for future use.

**AVCHD™**  
Progressive

**HDMI™**

**SDXC™** U3 I

**DOLBY**  
DIGITAL

**LEICA**  
DICOMAR

**PJ** **PB** **PX**

CG0718YA0 -FJ  
Printed in China

**ENGLISH**

DVQX1562ZA

# Information for Your Safety

## WARNING:

To reduce the risk of fire, electric shock or product damage,

- Do not expose this unit to rain, moisture, dripping or splashing.
- Do not place objects filled with liquids, such as vases, on this unit.
- Use only the recommended accessories.
- Do not remove covers.
- Do not repair this unit by yourself. Refer servicing to qualified service personnel.



## CAUTION!

To reduce the risk of fire, electric shock or product damage,

- Do not install or place this unit in a bookcase, built-in cabinet or in another confined space. Ensure this unit is well ventilated.
- Do not obstruct this unit's ventilation openings with newspapers, tablecloths, curtains, and similar items.
- Do not place sources of naked flames, such as lighted candles, on this unit.

**THE FOLLOWING APPLIES ONLY IN THE U.S.A. and CANADA.**

**The following mark and symbols are located on the bottom of the battery charger.**

	<b>CAUTION</b> RISK OF ELECTRIC SHOCK DO NOT OPEN		
<b>CAUTION: TO REDUCE THE RISK OF ELECTRIC SHOCK, DO NOT REMOVE SCREWS. NO USER-SERVICEABLE PARTS INSIDE. REFER SERVICING TO QUALIFIED SERVICE PERSONNEL.</b>			<p>The lightning flash with arrowhead symbol, within an equilateral triangle, is intended to alert the user to the presence of uninsulated "dangerous voltage" within the product's enclosure that may be of sufficient magnitude to constitute a risk of electric shock to persons.</p> <p>The exclamation point within an equilateral triangle is intended to alert the user to the presence of important operating and maintenance (servicing) instructions in the literature accompanying the appliance.</p>

## FCC NOTICE (USA)

### Declaration of Conformity

Model Number: AG-DVX200PJ  
Trade Name: Panasonic  
Responsible Party: Panasonic Corporation of North America  
Two Riverfront Plaza Newark NJ07102  
Support contact: 1-800-524-1448

This device complies with Part 15 of the FCC Rules.

Operation is subject to the following two conditions:

(1) This device may not cause harmful interference, and (2) this device must accept any interference received, including interference that may cause undesired operation.

To assure continued compliance, follow the attached installation instructions and do not make any unauthorized modifications.

### CAUTION:

This equipment has been tested and found to comply with the limits for a Class B digital device, pursuant to Part 15 of the FCC Rules. These limits are designed to provide reasonable protection against harmful interference in a residential installation. This equipment generates, uses and can radiate radio frequency energy and, if not installed and used in accordance with the instructions, may cause harmful interference to radio communications. However, there is no guarantee that interference will not occur in a particular installation. If this equipment does cause harmful interference to radio or television reception, which can be determined by turning the equipment off and on, the user is encouraged to try to correct the interference by one or more of the following measures:

- Reorient or relocate the receiving antenna.
- Increase the separation between the equipment and receiver.
- Connect the equipment into an outlet on a circuit different from that to which the receiver is connected.
- Consult the dealer or an experienced radio/TV technician for help.

The user may find the booklet "Something About Interference" available from FCC local regional offices helpful.

### FCC Warning:

To assure continued FCC emission limit compliance, follow the attached installation instructions and the user must use only shielded interface cables with ferrite core when connecting to host computer or peripheral devices. Also, any unauthorized changes or modifications to this equipment could void the user's authority to operate this device.

### NOTIFICATION (Canada)

CAN ICES-3(B)/NMB-3(B)

 indicates safety information.

**THE FOLLOWING APPLIES ONLY IN THE U.S.A.**

 **Panasonic**  
AG-DVX200

## AC adaptor

This AC adaptor operates on AC between 100 V and 240 V.

But

- In the U.S.A. and Canada, the AC adaptor must be connected to a 120 V AC power supply only.
- When connecting to an AC supply outside of the U.S.A. or Canada, use a plug adaptor to suit the AC outlet configuration.
- When connecting to a supply of greater than AC 125 V, ensure the cord you use is suited to the voltage of the AC supply and the rated current of the AC adaptor.
- Contact an electrical parts distributor for assistance in selecting a suitable AC plug adaptor or AC cord set.

## Battery charger

This battery charger operates on AC between 100 V and 240 V.

But

- In the U.S.A. and Canada, the battery charger must be connected to a 120 V AC power supply only.
- When connecting to an AC supply outside of the U.S.A. or Canada, use a plug adaptor to suit the AC outlet configuration.
- When connecting to a supply of greater than AC 125 V, ensure the cord you use is suited to the voltage of the AC supply and the rated current of the battery charger.
- Contact an electrical parts distributor for assistance in selecting a suitable AC plug adaptor or AC cord set.

### (AG-DVX200PJ/PB)

The power plug is the disconnecting device. Install this unit so that the power plug can be unplugged from the socket outlet immediately.

### (AG-DVX200PX)

The mains plug is the disconnecting device. Install this unit so that the mains plug can be unplugged from the socket outlet immediately.

### (AG-DVX200PX)

This unit is intended for use in moderate climates.

# IMPORTANT SAFETY INSTRUCTIONS

Read these operating instructions carefully before using the unit. Follow the safety instructions on the unit and the applicable safety instructions listed below. Keep these operating instructions handy for future reference.

- 1) Read these instructions.
- 2) Keep these instructions.
- 3) Heed all warnings.
- 4) Follow all instructions.
- 5) Do not use this apparatus near water.
- 6) Clean only with dry cloth.
- 7) Do not block any ventilation openings. Install in accordance with the manufacturer's instructions.
- 8) Do not install near any heat sources such as radiators, heat registers, stoves, or other apparatus (including amplifiers) that produce heat.
- 9) Do not defeat the safety purpose of the polarized or grounding-type plug. A polarized plug has two blades with one wider than the other. A grounding-type plug has two blades and a third grounding prong. The wide blade or the third prong are provided for your safety. If the provided plug does not fit into your outlet, consult an electrician for replacement of the obsolete outlet.
- 10) Protect the power cord from being walked on or pinched particularly at plugs, convenience receptacles, and the point where they exit from the apparatus.
- 11) Only use attachments/accessories specified by the manufacturer.
- 12) Use only with the cart, stand, tripod, bracket, or table specified by the manufacturer, or sold with the apparatus. When a cart is used, use caution when moving the cart/apparatus combination to avoid injury from tip-over.
- 13) Unplug this apparatus during lightning storms or when unused for long periods of time.
- 14) Refer all servicing to qualified service personnel. Servicing is required when the apparatus has been damaged in any way, such as power-supply cord or plug is damaged, liquid has been spilled or objects have fallen into the apparatus, the apparatus has been exposed to rain or moisture, does not operate normally, or has been dropped.



## ■ Concerning the battery

### Battery pack (Lithium ion battery pack)

- Use the specified unit to recharge the battery pack.
- Do not use the battery pack with equipment other than the specified unit.
- Do not get dirt, sand, liquids, or other foreign matter on the terminals.
- Do not touch the plug terminals (+ and -) with metal objects.
- Do not disassemble, remodel, heat or throw into fire.

If any electrolyte should come into contact with your hands or clothes, wash it off thoroughly with water.

If any electrolyte should come into contact with your eyes, never rub the eyes. Rinse eyes thoroughly with water, and then consult a doctor.

### Warning

Risk of fire, explosion and burns. Do not disassemble, heat above 60 °C (140 °F) or incinerate.

### CAUTION

- Danger of explosion if battery is incorrectly replaced. Replace only with the type recommended by the manufacturer.
- When disposing of the batteries, please contact your local authorities or dealer and ask for the correct method of disposal.

## ■ Product identification marking

Product	Location
Memory Card Camera-Recorder	Bottom
Battery charger	Bottom
AC adaptor	Bottom

Conforms to UL STD 60065.

Certified to CAN/CSA STD C22.2 No.60065.

### U.S.A./CANADA CONSUMERS: ATTENTION:



A lithium ion battery that is recyclable powers the product you have purchased. Please call 1-800-8-BATTERY for information on how to recycle this battery.

## ■ About the recording method for recording motion pictures

This unit can record motion pictures using three different recording methods, including MOV, MP4 and AVCHD\*.

\* AVCHD Progressive (1080/60p, 1080/50p) supported.

### MOV and MP4:

These recording methods are suitable for editing images. Audio is recorded in linear PCM.

- Those methods are not compatible with motion pictures recorded in AVCHD format.
- Those methods can record motion pictures in formats that support 4K. 4K motion pictures offer a resolution four times higher than that of full high-definition motion pictures.

### AVCHD:

This recording method is suitable for playback on a high-definition compatible external monitor. Audio is recorded in Dolby® Digital.

## ■ Regarding system frequencies

The NTSC/PAL region setting can be switched in [SYSTEM FREQ]. (→ 30)

- You cannot store AVCHD scenes recorded with different system frequencies on the same SD card. If you have switched the system frequency, use another SD card.

## ■ Indemnity about recorded content

Panasonic does not accept any responsibility for damages directly or indirectly due to any type of problems that result in loss of recording or edited content, and does not guarantee any content if recording or editing does not work properly. Likewise, the above also applies in a case where any type of repair is made to the unit.

## ■ About Condensation (When the lens, the viewfinder or LCD Monitor is fogged up)

Condensation occurs when there is a change in temperature or humidity, such as when the unit is taken from outside or a cold room to a warm room. Please be careful, as it may cause the lens, the viewfinder or LCD monitor to become soiled, moldy, or damaged.

When taking the unit to a place which has a different temperature, if the unit is accustomed to the room temperature of the destination for about one hour, condensation can be prevented. (When the difference in temperature is severe, place the unit in a plastic bag or the like, remove air from the bag, and seal the bag.) When condensation has occurred, remove the battery and/or the AC adapter and leave the unit like that for about one hour. When the unit becomes accustomed to the surrounding temperature, fogginess will disappear naturally.

## ■ About security

Be careful about the possibility of theft or loss of the unit, and be careful not to leave the unit unattended. Please note that Panasonic does not accept any responsibility for the compromise, manipulation, and loss of information caused by these events.

## ■ Caution regarding laser beams

The lens may suffer damage if struck by a laser beam. Make sure that laser beams do not strike the lens when shooting in an environment where laser devices are used.

## ■ Caution regarding the lens and the viewfinder



Do not aim the lens or the viewfinder at the sun or strong light. Doing so may cause your camcorder to malfunction.

## ■ Cards that you can use with this unit

### SDHC Memory Card and SDXC Memory Card

- 4 GB or more Memory Cards that do not have the SDHC logo or 48 GB or more Memory Cards that do not have the SDXC logo are not based on SD Memory Card Specifications.
- Refer to page 23 for more details on SD cards.

## ■ For the purposes of these operating instructions

- The battery pack is referred to as the "Battery".
- SDHC Memory Card and SDXC Memory Card are referred to as the "SD card".
- Function that can be used for Recording Mode: 
- Function that can be used for Playback Mode: 
- Scene(s) recorded with [REC MODE] set to [MOV] or [MP4]: "MOV/MP4 scene(s)".
- Scene(s) recorded with [REC MODE] set to [AVCHD]: "AVCHD scene(s)".
- Pages for reference are indicated by an arrow, for example: → 00
- These operating instructions are designed for use with models AG-DVX200PJ/PB/PX. Such as screen illustrations are as an example AG-DVX200PJ.



# Contents

<b>Information for Your Safety</b> .....	2
<b>Accessories</b> .....	10
Optional accessories.....	10

---

## Preparation

---

<b>What you can do with this unit</b> .....	11
Recording to the SD card.....	11
Linking to external devices.....	11
Remote operations with an iPad.....	12
<b>Names and Functions of Main Parts</b> .....	13
<b>Power supply</b> .....	19
Charging the battery.....	19
Inserting/removing the battery.....	20
Charging and recording time.....	21
Connecting to the AC outlet.....	22
<b>Preparation of SD cards</b> .....	23
Cards that you can use with this unit.....	23
Inserting/removing an SD card.....	24
<b>Turning the unit on/off</b> .....	25
<b>Selecting a mode</b> .....	25
<b>Using the LCD monitor/Viewfinder</b> .....	26
Using the LCD monitor.....	26
How to use the touch screen.....	27
Viewfinder adjustment.....	27
<b>Setting date and time</b> .....	28

---

## Recording

---

<b>Selecting the Recording Method</b> .....	29
Formatting media.....	29
System frequency Selection.....	30
Language Selection.....	30
<b>Selecting a media to record</b> .....	30
<b>Recording motion picture with this unit</b> .....	31
<b>Recording still pictures</b> .....	31
<b>Switching between Auto and Manual Mode</b> .....	32
<b>Using the zoom</b> .....	33
<b>Manual Recording</b> .....	34
Focus.....	34
White Balance.....	34

Iris/Gain adjustment.....	35
Manual shutter speed.....	35
<b>USER button</b> .....	36
Setting the USER button.....	36
Using the USER button.....	36
Functions of the USER button.....	37

---

## Playback

---

<b>Motion picture/Still picture playback</b> .....	39
--	----

---

## Menu

---

<b>Using the menu screen</b> .....	41
<b>Menu structure</b> .....	42

---

## Others

---

<b>Cautions for use</b> .....	44
<b>About copyright</b> .....	47
<b>Specification</b> .....	49

# Accessories

Check the accessories before using this unit.

Keep the accessories out of reach of children to prevent swallowing.

## Battery pack\*<sup>1</sup>



## Battery charger

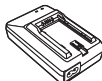

## AC adaptor



## AC cable (2 cables) (AG-DVX200PJ)



## AC cable (2 cables) (AG-DVX200PB)



## AC cable (2 cables) (AG-DVX200PX)



## Microphone holder (→ 18)



## Microphone holder mounting screws (→ 18) 12 mm length (0.47 ") (2 screws)



## Eye cup (→ 17)



## INPUT terminal cap (2 caps)\*<sup>2</sup>



## Shoulder strap (→ 17)



## Lens hood\*<sup>3</sup>



\*1 The part number of the battery pack is AG-VBR59. Before purchasing an extra battery pack, check the optional accessories section. To purchase extra accessories, contact your dealer.

\*2 The INPUT terminal caps are supplied with the microphone holder.

\*3 The lens hood is attached to this unit at the time of purchase.

## Optional accessories

Some optional accessories may not be available in some countries.

Super-directional Electret Microphone (AG-MC200G)
Battery pack (lithium/VW-VBD58/AG-VBR59/ AG-VBR89/AG-VBR118)
Battery charger (AG-B23/AG-BRD50)
LED video light (VW-LED1)

**Product numbers correct as of October 2018. These may be subject to change.**

# What you can do with this unit

This unit is a 4K\*<sup>1</sup> camera recorder with the following features:

\*<sup>1</sup> Please refer to page 49 about recording format of this unit.

- The 4/3-type large sensor allows you to record beautifully defocused images with shallow depth of field as ultra high-definition 4K motion picture.
- V-Log L (12 stops) allows you to record expressive images with greater latitude.
- Recording at a variable frame rate of up to 120 fps (for FHD) is possible.
- It incorporates the 5-Axis Hybrid Image Stabilizer, Custom AF function, and ND filters (1/4, 1/16, and 1/64).
- Supported recording media include SDHC Memory Card and SDXC Memory Card.

## Recording to the SD card

A variety of recording functions support recording to the SD card.

- This unit supports relay/simultaneous/background/dual codec recording using double card slots.

## Linking to external devices

### USB Device Mode

Transfer data (files) to perform nonlinear editing on another device (PC, etc.).

- This unit supports USB 3.0.

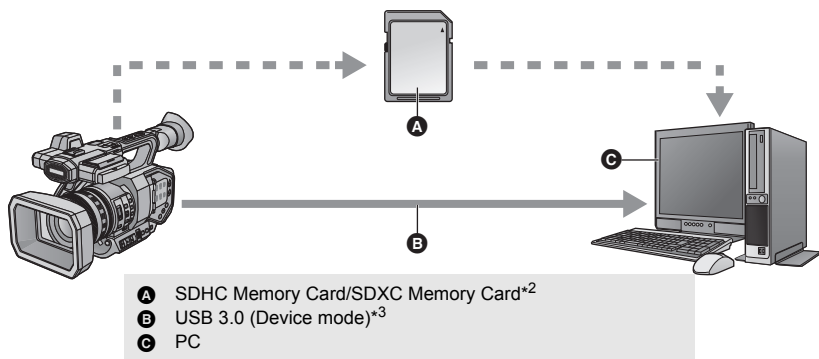

\*<sup>2</sup> SD cards are optional and not supplied with this unit.

\*<sup>3</sup> A USB 3.0 cable is not supplied with this unit. Use a commercially-available double-shielded USB 3.0 cable with a ferrite core.

If possible, we recommend using a cable with a length of 1.5 m (4.9 feet) or less.

## USB Host Mode

If you connect an external media device, such as USB HDD or USB flash memory (commercially-available) to this unit, you can copy motion pictures and still pictures recorded on this unit to the external media device.

It can also play back the scenes and still pictures copied to the external media device.

- This unit supports USB 3.0.

**Refer to the following support site for information about an external media device.**

<https://pro-av.panasonic.net/>

(This Site is English only)

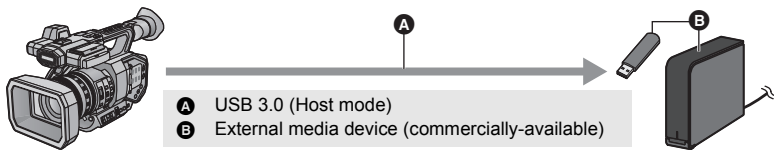

## Connecting to an external monitor

Connect an external monitor to output images.

- It is also possible to output 4:2:2 (10bit) images, depending on the [OUTPUT BITS] setting.

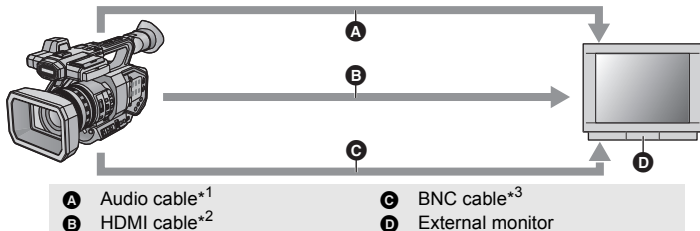

\*1 Use a commercially-available audio cable (3.5 mm (0.14 ") diameter jack to RCA cable).

\*2 Use a commercially-available High Speed HDMI cable.

If possible, we recommend using a cable with a length of 3 m (9.84 feet) or less.

\*3 To connect to the SDI OUT or VIDEO OUT terminal, use a double-shielded BNC cable equivalent to 5C-FB (commercially-available).

**When connecting with an HDMI cable using an HDMI-to-DVI converter, etc., be sure to connect the HDMI cable to the connector of this unit last.**

**Connecting the HDMI cable to the connector of this unit first may result in malfunction.**

## Remote operations with an iPad

Attaching a wireless module that support this unit (Panasonic AJ-WM30, ASUS USB-N53 (Ver.A1): optional) to the USB HOST terminal of this unit allows you to connect to a wireless LAN network.

You can perform the following operations by connecting this unit and an iPad on which the AG ROP application is installed:

- Checking the camera status
- Playing back scenes recorded as sub recordings with [DUAL CODEC REC] set to [FHD 8Mbps] and checking the thumbnails of these scenes
- Controlling the camera remotely (recording control and Time Code/User Information operations)

# Names and Functions of Main Parts

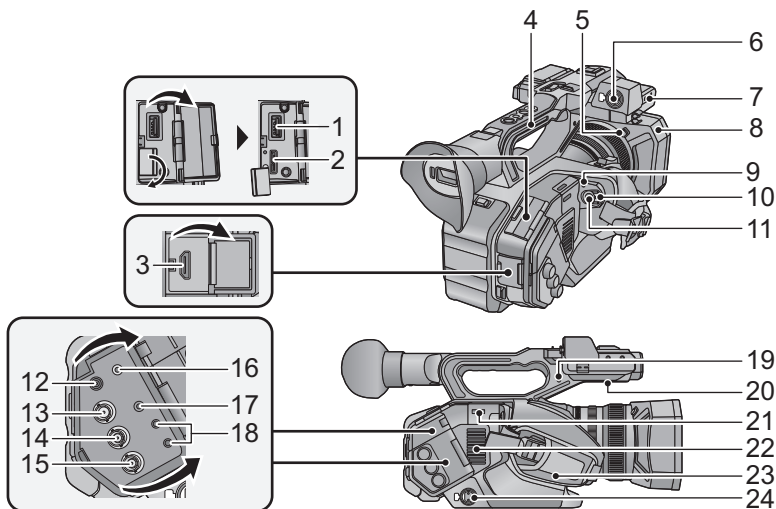

- 1 USB HOST terminal
- 2 USB DEVICE terminal
- 3 HDMI OUT connector [HDMI]
- 4 Handle
- 5 Lens hood release button
- 6 Audio input terminal 1 (XLR 3 pin) [AUDIO INPUT1] (→ 18)
- 7 Microphone holder attachment part (→ 18)
- 8 Lens hood
- 9 Status indicator (→ 25)
- 10 Power switch (→ 25)
- 11 Recording start/stop button (→ 31)
- 12 DC input terminal [DC IN] (→ 22)
  - Do not use any other AC adaptors except the supplied one.
- 13 SDI OUT terminal
- 14 TC PRESET IN/OUT terminal
- 15 VIDEO OUT terminal
- 16 Headphone terminal [ ]
  - Excessive sound pressure from earphones and headphones can cause hearing loss.
  - Listening at full volume for long periods may damage the user's ears.
- 17 AUDIO OUT terminal
- 18 Camera remote terminal [CAM REMOTE]
  - FOCUS IRIS terminal (3.5 mm (0.14 ") diameter mini jack)
  - ZOOM S/S terminal (2.5 mm (0.1 ") diameter super mini jack)
- 19 Pin holder
  - Attaches the zoom ring pin removed from this unit.
- 20 Speaker
- 21 Shoulder strap fixture (→ 17)
- 22 Inlet (cooling fan)
- 23 Hand strap (→ 17)
- 24 Audio input terminal 2 (XLR 3 pin) [AUDIO INPUT2] (→ 18)

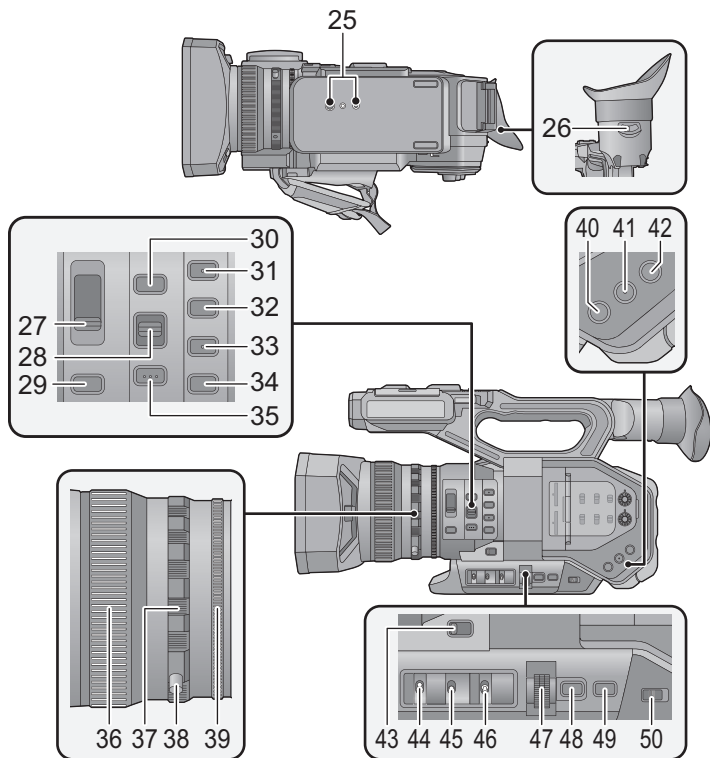

- |    |   |    |   |
|----|---|----|---|
| 25 | Tripod receptacle (→ 18)                        | 40 | User 5 button [O.I.S.] (→ 36)             |
| 26 | Eyepiece corrector lever (→ 27)                 | 41 | User 6 button [ZEBRA] (→ 36)              |
| 27 | ND filter switch [ND FILTER]                    | 42 | User 7 button [WFM] (→ 36)                |
| 28 | Focus auto/Manual/∞ switch [FOCUS A/M/∞] (→ 34) | 43 | Zoom switch [MANU/SERVO] (→ 33)           |
| 29 | Iris button [IRIS] (→ 34)                       | 44 | Display/Mode check switch [DISP/MODE CHK] |
| 30 | FOCUS ASSIST button                             | 45 | Gain switch [GAIN] (→ 35)                 |
| 31 | User 1 button [USER1] (→ 36)                    | 46 | White Balance switch [WHITE BAL] (→ 34)   |
| 32 | User 2 button [USER2] (→ 36)                    | 47 | Jog dial [SEL/PUSH SET] (→ 34)            |
| 33 | User 3 button [USER3] (→ 36)                    | 48 | Menu button [MENU] (→ 41)                 |
| 34 | User 4 button [USER4] (→ 36)                    | 49 | Shutter speed button [SHUTTER] (→ 35)     |
| 35 | PUSH AUTO button                                | 50 | Auto/Manual switch [AUTO/MANU] (→ 32)     |
| 36 | Focus ring (→ 34)                               |    |   |
| 37 | Zoom ring (→ 33)                                |    |   |
| 38 | Zoom ring pin                                   |    |   |
| 39 | Iris ring (→ 34)                                |    |   |

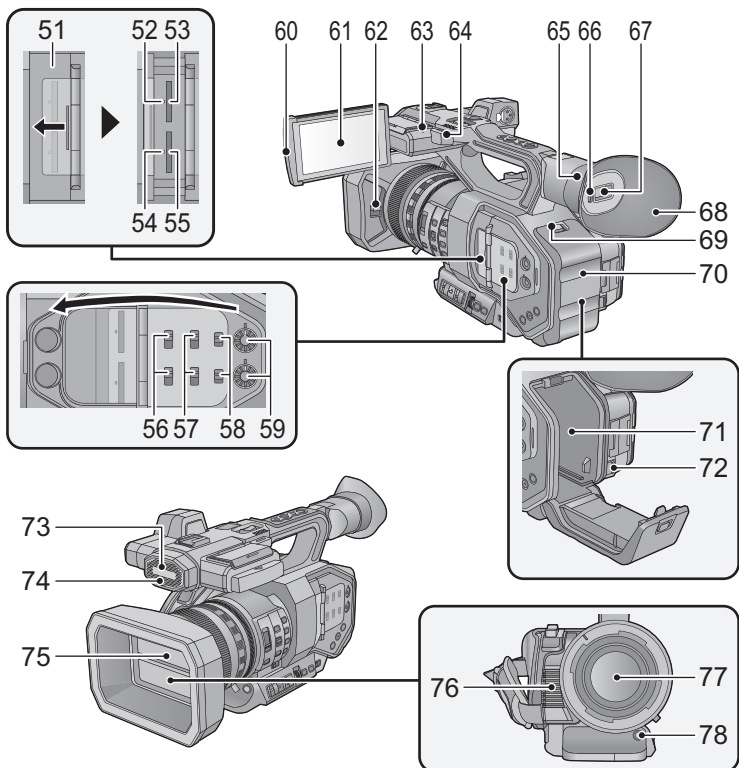

- 51 SD Card slot cover (→ 24)
- 52 Access lamp (card 1) (→ 24)
- 53 Card slot 1 (→ 24)
- 54 Access lamp (card 2) (→ 24)
- 55 Card slot 2 (→ 24)
- 56 INPUT1 / INPUT2 switches
- 57 CH1 SELECT/CH2 SELECT switches
- 58 CH1/CH2 switches
- 59 AUDIO LEVEL CH1/AUDIO LEVEL CH2 knobs
- 60 LCD monitor extract part (→ 26)
- 61 LCD monitor (Touch screen) (→ 27)
- 62 Lens cover open/close lever (→ 16)
- 63 Recording lamp (Rear)
- 64 Shoulder strap fixture (→ 17)

- 65 Eye cup mount (→ 17)
- 66 Eye sensor
- 67 Viewfinder (→ 27)
- 68 Eye cup (→ 17)
- 69 Open/close lever [OPEN] (→ 20)
- 70 Battery cover (→ 20)
- 71 Battery holder (→ 20)
- 72 Battery release lever [BATTERY] (→ 20)
- 73 Built-in microphone
- 74 Recording lamp (Front)
- 75 Lens cover (→ 16)
- 76 Exhaust opening (cooling fan)
- 77 Lens (LEICA DICOMAR)
- 78 Auto white balance button [AWB] (→ 34, 36)

● This button is used as a USER button.

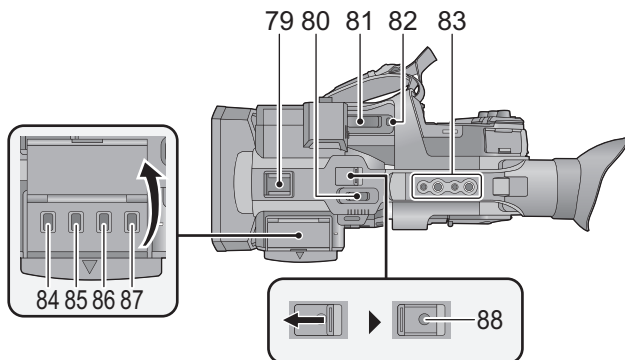

**79 Accessory shoe**

**80 Sub zoom lever (→ 33)**

- This lever functions in the same manner as the zoom lever.

**81 Zoom lever [T/W] (In Recording Mode) (→ 33)**

**Volume lever [+VOL-]/Thumbnail display switch [Q / ] (In Playback Mode)**

**82 User 8 button [REC CHECK] (→ 36)**

**83 Handle mounting hole**

(Size of the mounting hole)

- 1/4-20UNC×2
- 3/8-16UNC×2

**84 Thumbnail button [THUMBAIL] (→ 25)**

**85 Counter button [COUNTER]**

**86 Counter reset/Time code setting button [RESET/TC SET]**

**87 Color Bar Screen button [BARS]**

**88 Sub recording start/stop button**

- This button functions in the same manner as the recording start/stop button.

## ■ Opening/closing the lens cover

You can open/close the lens cover by sliding the lens cover open/close lever.

- When this unit is not in use, close the lens cover to protect the lens.

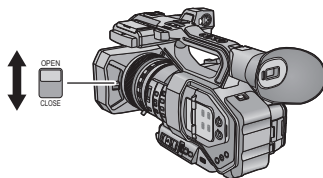

- Do not press the lens cover hard. This may damage the lens or the lens cover.
- Depending on the various filters or the MC protector attached to the front side of this unit's lens, you may not be able to open/close the lens cover or attach the lens hood.



## ■ Adjust the length of the hand strap so that it fits your hand.

Adjust the hand strap according to the size of your hand.

- If you find it difficult to fasten the buckle **B**, move the pad **A** towards you, and fasten the buckle **B** again.

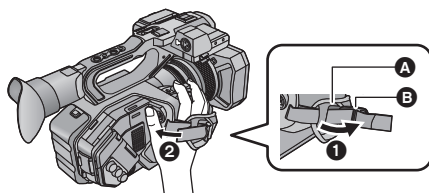

- 1 Open the buckle.
- 2 Pull the end of the belt.

## ■ Attaching the eye cup

- 1 Align the mounting mark on the eye cup mount with the corresponding mark on the eyecup.
- 2 Attach the eye cup so that the notch on the eye cup mount is aligned with the protrusion inside the eye cup.

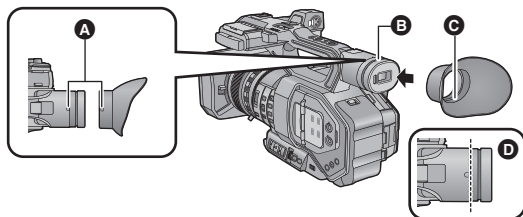

- A** Mounting marks
- B** Notch
- C** Protrusion

- Push the eye cup in until it reaches the mounting mark. **(D)**

## ■ Attaching the Shoulder strap

We recommend that you attach the shoulder strap (supplied) before going out of doors to record so as to avoid dropping this unit.

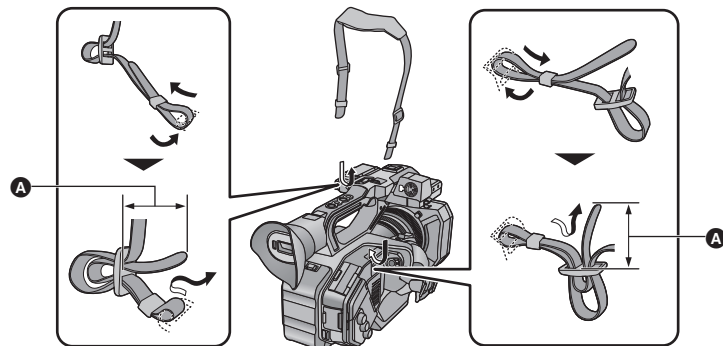

- A** 20 mm (0.8 ") or longer

## ■ Attaching the front microphone

- The microphone holder is set up so that a 21 mm (0.83 ") external microphone (AG-MC200G: optional) can be attached. Check in advance whether the microphone you wish to use can be attached.

### 1 Attach the microphone holder to the microphone holder attachment part.

- Attach by using a commercially available screw driver.
- When attaching the microphone holder, be sure to tighten the screws firmly even though you might hear a squeaking sound.

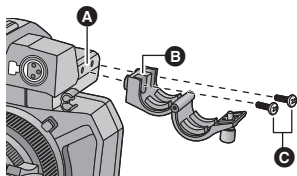

- A** Microphone holder attachment part
- B** Microphone holder
- C** Microphone holder mounting screws

### 2 Attach an external microphone (optional) to the microphone holder, and tighten the microphone holder screw.

### 3 Connect the external microphone to the AUDIO INPUT1 terminal (XLR 3 pin).

- When wiring the microphone cable, use the cable clamper of this unit.
- Keep the microphone holder screw, zoom ring pin and INPUT terminal cap out of reach of children to prevent swallowing.

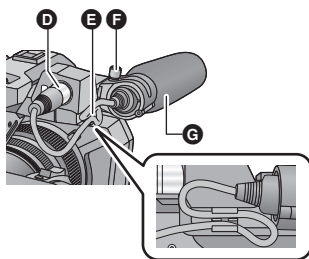

- D** AUDIO INPUT1 terminal (XLR 3 pin)
- E** Microphone cable clamper
- F** Microphone holder screw
- G** External microphone (optional)

## ■ Attaching the INPUT terminal cap

Attach the INPUT terminal cap while the AUDIO INPUT1, 2 terminals (XLR 3 pin) are not used.

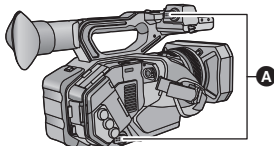

- A** INPUT terminal cap

## ■ Attaching the tripod

- There are tripod mounting holes that are compatible with 1/4-20UNC and 3/8-16UNC screws. Use the size that matches the diameter of the tripod's fixing screw.
- Attaching a tripod with a screw length of 5.5 mm (0.22 ") or more may damage the unit.

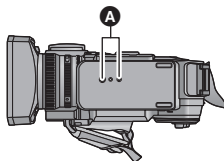

- A** Tripod receptacle

## Power supply

### ■ About batteries that you can use with this unit (as of October 2018)

The battery that can be used with this unit is VW-VBD58/AG-VBR59/AG-VBR89/AG-VBR118.

It has been found that counterfeit battery packs which look very similar to the genuine product are made available to purchase in some markets. Some of these battery packs are not adequately protected with internal protection to meet the requirements of appropriate safety standards. There is a possibility that these battery packs may lead to fire or explosion. Please be advised that we are not liable for any accident or failure occurring as a result of use of a counterfeit battery pack. To ensure that safe products are used we would recommend that a genuine Panasonic battery pack is used.

## Charging the battery

When this unit is purchased, the battery is not charged. Charge the battery fully before using this unit for the first time.

### Important:

- Do not use the AC cable with any other equipment as it is designed only for this unit. Also, do not use the AC cable from other equipment with this unit.
- It is recommended to charge the battery in a temperature between 10 °C and 30 °C (50 °F and 86 °F).  
(The battery temperature should also be the same.)

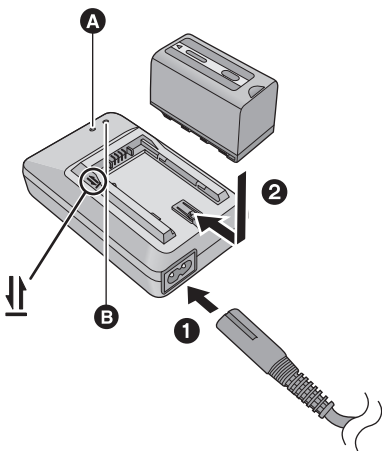

### Charging lamp [CHARGE] **A**

Lights up:

Charging (Battery charging time: → 21)

Goes off:

Charging completed

Flashing:

Be sure to connect the unit correctly (→ 46)

### Power lamp [POWER] **B**

- This will light up when the AC cable is connected.

- Insert the plugs as far as they will go.

**1** Connect the AC cable to the battery charger and the AC outlet.

## 2 Insert the battery into the battery charger by aligning the arrows.

- We recommend using Panasonic batteries (→ 10, 19, 21).
- If you use other batteries, we cannot guarantee the quality of this product.
- Do not heat or expose to flame.
- Do not leave the battery(ies) in a car exposed to direct sunlight for a long period of time with doors and windows closed.

## Inserting/removing the battery

### 1 Slide the open/close lever, and open the battery cover.

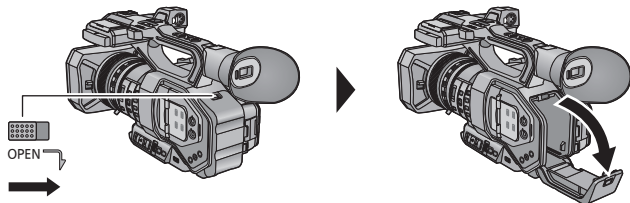

### 2 Install the battery by inserting it in the direction shown in the figure.

- Insert the battery until it clicks and locks.

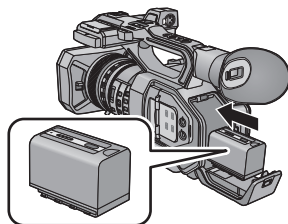

### 3 Close the battery cover.

- Close the battery cover until it clicks and locks.

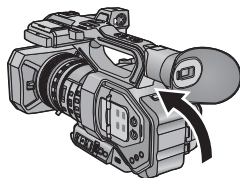

### Removing the battery

Make sure that the power switch is set to OFF and the status indicator is turned off, and then remove by holding onto it taking care not to drop. (→ 25)

#### Open the battery cover, and slide the battery release lever.

- The battery will be unlocked, allowing you to take it out.
- Slide the battery release lever in the direction indicated by the arrow.

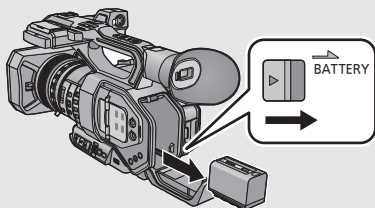

# Charging and recording time







## Charging/Recording time

Battery model number	Voltage/Capacity (minimum)	Charging time	Continuously recordable time
Supplied battery/ AG-VBR59 (optional)	7.28 V/5900 mAh	385 min	160 min

- The times given apply when the ambient operating temperature is 20 °C (68 °F) and the relative operating humidity is 60%. Charging time may be longer at other temperatures and humidity levels.
- The continuous recordable time given applies under the conditions below. The time becomes shorter under other conditions.
  - The LCD monitor is open
  - A cable is not inserted to the external output terminal
- "h" is an abbreviation for hour, "min" for minute and "s" for second.
- These times are approximations.
- **The indicated charging time is for when the battery has been discharged completely. Charging time and recordable time vary depending on the usage conditions such as high/low temperature.**
- The AG-VBR59 (supplied) is a battery pack that supports quick charging. It is possible to perform quick charging by using the optional AG-BRD50 for charging.

- The batteries heat up after use or charging. This is not a malfunction.

## Battery capacity indication

- The display changes as the battery capacity reduces.  →  →  →  → 
- If the battery discharges, then  will flash red.

## Connecting to the AC outlet

---

The unit is in the standby condition when the AC adaptor is connected. The primary circuit is always "live" as long as the AC adaptor is connected to an electrical outlet.

**Important:**

- Use the supplied AC adaptor. Do not use the AC adaptor of another device.
- Do not use the AC cable with any other equipment as it is designed only for this unit. Also, do not use the AC cable from other equipment with this unit.

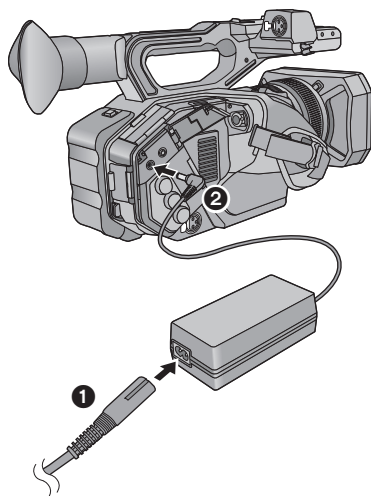

**1** Connect the AC cable to the AC adaptor and the AC outlet.

**2** Connect the AC adaptor to the DC input terminal [DC IN].

- Make sure to set the power switch to OFF and the status indicator is turned off when disconnecting the AC adaptor. (→ 25)

- Insert the plugs as far as they will go.

- 
- Even when you use the AC adaptor for recording images, keep the battery connected. This allows you to continue the recording even if a power failure occurs or the AC adaptor is unplugged from the AC outlet by accident.

## Preparation of SD cards

The unit can record motion pictures or still pictures to an SD card.





- We recommend that you use a Panasonic Memory Card.

This unit (an SDXC compatible device) is compatible with SDHC Memory Cards and SDXC Memory Cards. When using an SDHC Memory Card/SDXC Memory Card with other equipment, check the equipment is compatible with these Memory Cards.

## Cards that you can use with this unit

### ■ About the Speed Class ratings for recording motion pictures

- Depending on [REC MODE] and [REC FORMAT], the required card differs.  
Use a card that meets the following ratings of the SD Speed Class or UHS Speed Class.  
Use of a non-compatible card may cause recording to stop suddenly.
- SD Speed Class and UHS Speed Class are the speed standards regarding continuous writing. To check the class, see the labelled side, etc. of the card.
- We recommend that you use an SD card compatible with UHS Speed Class3 when recording in Variable Frame Rate Mode.

Recording modes	Bit rates in [REC FORMAT]	Speed Class ratings	Label examples
MOV/MP4	100 Mbps or more	UHS Speed Class3*	
	50 Mbps	UHS Speed Class1 or more	
		Class10 or more	
AVCHD	All	Class4 or more	

\* When [UHD 2160/59.94p 150M] or [UHD 2160/50.00p 150M] is selected, an SDXC Memory Card with a capacity of 64 GB or more and a Speed Class rating of UHS Speed Class3 is required.

- Keep the Memory Card out of reach of children to prevent swallowing.

## Inserting/removing an SD card

When using an SD card for the first time, it is necessary to format the SD card. (→ 29) When the SD card is formatted, all of the recorded data is deleted. Once the data is deleted, it cannot be restored.

### Caution:

Check that the access lamp has gone off.

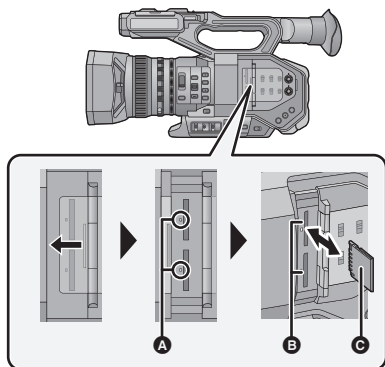

### Access lamp **A**

- When this unit is accessing the SD card, the access lamp lights up.

### 1 Open the SD card slot cover and insert (remove) the SD card into (from) the card slot **B**.

- One SD card can be inserted into each of the card slot 1 and the card slot 2.
- Face the terminal side **C** in the direction shown in the illustration and press it straight in as far as it will go.
- Press the center of the SD card and then pull it straight out.

### 2 Securely close the SD card slot cover.

- Do not touch the terminals on the back of the SD card.
- Do not apply strong shocks, bend, or drop the SD card.
- Electrical noise, static electricity or the failure of this unit or the SD card may damage or erase the data stored on the SD card.
- When the card access lamp is lit, do not:
  - Remove the SD card
  - Turn the unit off
  - Insert and remove the USB Cable
  - Expose the unit to vibrations or shockPerforming the above while the lamp is on may result in damage to data/SD card or this unit.
- Do not expose the terminals of the SD card to water, dirt or dust.
- Do not place SD cards in the following areas:
  - In direct sunlight
  - In very dusty or humid areas
  - Near a heater
  - Locations susceptible to significant difference in temperature (condensation can occur.)
  - Where static electricity or electromagnetic waves occur
- To protect SD cards, return them to their cases when you are not using them.
- About disposing of or giving away the SD card. (→ 46)



## Turning the unit on/off

Set the power switch to ON while pressing the lock release button **B** to turn on the unit.

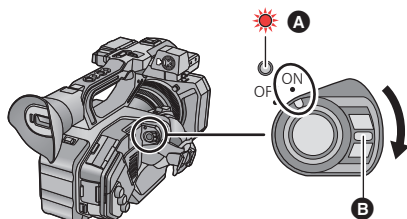

**A** The status indicator lights on.

### To turn off the unit

Set the power switch to OFF while pressing the lock release button. The status indicator goes off.

- To turn on the unit again after the [ECONOMY (BATT)] or [ECONOMY (AC)] is activated, set the power switch to OFF once, and then to ON again.

## Selecting a mode

Press the THUMBNAIL button to change the mode to Recording Mode or Playback Mode.

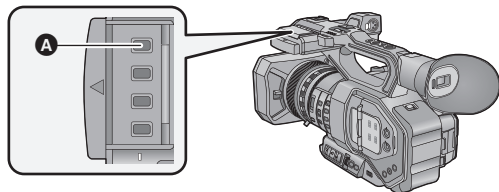

**A** THUMBNAIL button

<b>Recording Mode (→ 31)</b>	The recording screen is displayed. You can record motion pictures and still pictures.
<b>Playback Mode (→ 39)</b>	The thumbnail screen for playback is displayed. You can play back motion pictures and still pictures.

- When you turn on this unit, it starts up in Recording Mode.
- If you press the recording start/stop button or sub recording start/stop button in Playback Mode, the mode will be switched to Recording Mode and recording will start.

# Using the LCD monitor/Viewfinder

The LCD monitor is turned on when the LCD monitor is extracted. When you move your eye closer to the eye cup of the viewfinder, the LCD monitor is turned off, and the viewfinder is turned on.

## Using the LCD monitor

**1** Extract the LCD monitor in the direction as indicated in the figure.

- Hold the LCD monitor extract part **A**, and extract the LCD monitor until it clicks into position.

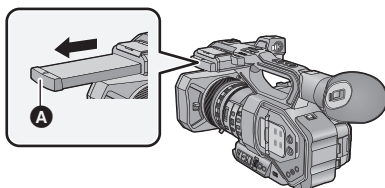

**2** Rotate to the position that is easy to view.

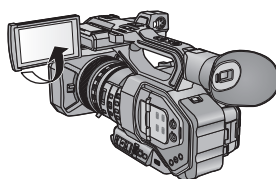

### *To retract the LCD monitor*

Retract as shown in the figure with the LCD facing downward.

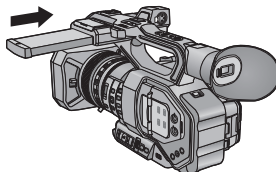

### *Range of rotation of the LCD monitor*

- It can rotate up to 270° towards the lens.

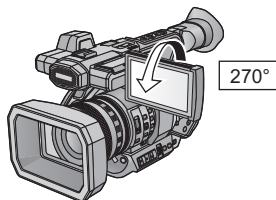

# How to use the touch screen

You can operate by directly touching the LCD monitor (touch screen) with your finger.

## ■ Touch

Touch and release the touch screen to select icon or picture.

- Touch the center of the icon.
- Touching the touch screen will not operate while you are touching another part of the touch screen.

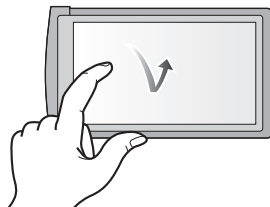

## ■ Slide while touching

Move your finger while pressing on the touch screen.

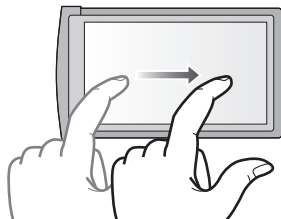

## ■ About the operation icons



Touch when changing a page or performing settings.

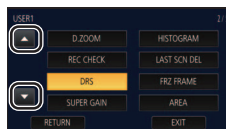

- Do not touch the LCD monitor with hard pointed tips, such as ball point pens.

# Viewfinder adjustment

## Adjusting the field of view

This setting will not affect the images actually recorded.

It adjusts the field of view to show the image on the viewfinder clearly.

### 1 Adjust the viewfinder to suit your vision so that you can see the display images clearly.

- Be careful not to trap your fingers when moving the viewfinder.
- The viewfinder can be lifted vertically up to approximately 90°.
- Turn on the viewfinder.

### 2 Adjust the focus by operating the eyepiece corrector lever.

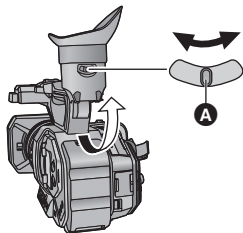

**A** Eyepiece corrector lever

# Setting date and time

When this unit is turned on, the message [SET TIME ZONE AND DATE/TIME] may appear. To make these settings, select [YES], and follow the instructions from Step 2-3 of the time zone setting procedure.

## 1 Select the menu. (→ 41)

MENU  : [OTHER FUNCTION] → [CLOCK SET]

## 2 Touch the date or time to be set, then set the desired value using / .

- The year can be set between 2000 and 2039.

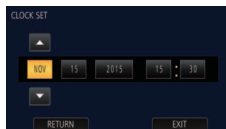

## 3 Touch [EXIT] to complete the setting.

- The date and time function is driven by a built-in lithium battery.
- If the time display becomes [- -], the built-in lithium battery needs to be charged. To recharge the built-in lithium battery, connect the AC adaptor or attach a charged battery to this unit. Leave the unit as it is for approx. 24 hours and the battery will maintain the date and time for approx. 6 months. (The battery is still being recharged even if the unit is off.)
- The way that time is displayed can be changed in the menu settings.  
[DISP SETUP] → [DATE/TIME] or [DATE FORMAT]

## Time zone

Time difference from the Greenwich Mean Time can be set.

### 1 Select the menu. (→ 41)

MENU  : [OTHER FUNCTION] → [TIME ZONE]

### 2 Touch / and set the region to record.

### 3 Touch [EXIT] to complete the setting.

- If the [CLOCK SET] screen appears, perform [CLOCK SET].
- When the time zone setting is changed, the date/time setting of the unit also changes automatically.



## Selecting the Recording Method

When recording to the SD card with this unit, set [OUTPUT BITS] to [4:2:2(8bit)].



When recording with an external device connected via the HDMI OUT/SDI OUT terminal, you can change the picture quality of images output to the device by changing the [OUTPUT BITS] setting.

Select the menu. (→ 41)

 : [SYSTEM MODE] → [OUTPUT BITS] → desired setting

**[4:2:2(10bit)]:** Allows you to output high quality images using an HDMI/SDI connection. This setting is suitable for recording with an external device that supports HDMI/SDI output. You cannot record these images with this unit.

**[4:2:2(8bit)]:** Allows you to output the image being recorded with this unit.

- When [4:2:2(10bit)] is selected,  and  are displayed on the screen.
- The setting method of the picture quality of the image changes depending on the [OUTPUT BITS] setting.
  - When [4:2:2(10bit)] is selected, change the [OUTPUT FORMAT] setting.
  - When [4:2:2(8bit)] is selected, change the [REC MODE] and [REC FORMAT] setting.
- Please refer to “Operating Instructions Vol.2” (PDF file) for more information about [OUTPUT FORMAT] and [REC FORMAT].

- This function is not available in the following cases:
  - During Freeze Frame
  - In Variable Frame Rate Mode
- **The following menu items are not available when [4:2:2(10bit)] is selected:**
  - [VFR MODE]
  - [REC MODE]
  - [REC FORMAT]
  - [SUB REC BUTTON]
  - [2 SLOTS FUNC.]
  - [DUAL CODEC REC]
  - [INTERVAL REC]
  - [PRE-REC]
  - [TIME STAMP]
  - [DOWN CONV.]
  - [VIDEO OUT OSD]
  - [MEDIA SELECT]
  - [MEDIA STATUS]
- The following functions are not available when [4:2:2(10bit)] is selected:
  - [DIGITAL ZOOM]
  - [REC CHECK]
  - [LAST SCN DEL]

## Formatting media

If you use the SD cards for the first time for recording with this unit, format the cards. Please be aware that if a medium is formatted, then all the data recorded on the medium will be erased and cannot be restored. Back up important data on a PC etc.

- When using two SD cards, format both SD cards.

## 1 Select the menu. (→ 41)

 : [OTHER FUNCTION] → [FORMAT MEDIA]

## 2 Touch [SD CARD 1] or [SD CARD 2].

- When formatting is complete, touch [EXIT] to exit the message screen.
- Do not turn this unit off or remove the SD card, while formatting. Do not expose the unit to vibrations or shock.

**Use this unit to format media.**

**Do not format an SD card using any other equipment such as a PC. Otherwise it may not be possible to use the card on this unit.**

## System frequency Selection

Set the system frequency of this unit.

### Select the menu. (→ 41)

(In Recording Mode)

 : [SYSTEM MODE] → [SYSTEM FREQ] → [59.94Hz] or [50.00Hz]

(In Playback Mode)

 : [OTHER FUNCTION] → [SYSTEM FREQ] → [59.94Hz] or [50.00Hz]

- After you have changed the system frequency, this unit will be restarted automatically.
- By default, the system frequency is set to the broadcasting system of the region where this product was purchased.
- This function's default setting is [59.94Hz].

## Language Selection

You can select the language on the screen display and the menu screen.

### 1 Select the menu. (→ 41)

 : [OTHER FUNCTION] → [LANGUAGE]

### 2 Touch the desired setting language.

Recording



## Selecting a media to record

[SD CARD 1] and [SD CARD 2] can be selected separately to record motion pictures or still pictures.

- Set [OUTPUT BITS] to [4:2:2(8bit)]. (→ 29)

### 1 Select the menu. (→ 41)

 : [RECORD SETUP] → [MEDIA SELECT]

## 2 Touch the media to record motion pictures or still pictures.

- The media is selected separately for motion pictures or still pictures and is then highlighted in yellow.

## 3 Touch [EXIT] to complete the setting.



- You can also change the card slot used for motion picture recording by pressing the USER button to which [SLOT SEL] is registered or touching the applicable USER button icon while recording is paused. (→ 36)

Recording



## Recording motion picture with this unit

- Before turning on this unit, open the lens cover. (→ 16)
- Set [OUTPUT BITS] to [4:2:2(8bit)]. (→ 29)

### 1 Change the mode to Recording Mode. (→ 25)

- Extract the LCD monitor.

### 2 Press the recording start/stop button **B** to start recording.

- A** When you begin recording, REC (red) is displayed.
- Recording will stop when you press the recording start/stop button again.

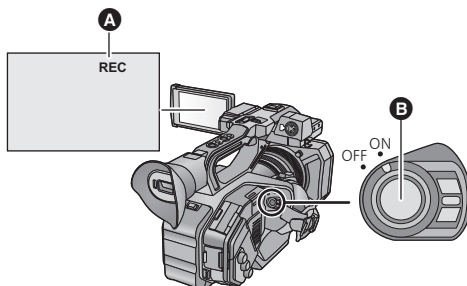

Recording



## Recording still pictures

- Before turning on this unit, open the lens cover. (→ 16)
- Set [OUTPUT BITS] to [4:2:2(8bit)]. (→ 29)
- Register [CAPTURE] to a USER button. (→ 36)

### 1 Change the mode to Recording Mode. (→ 25)

- Extract the LCD monitor.

### 2 Press the USER button to which [CAPTURE] is registered or touch the applicable USER button icon to record a still picture.

- For information on the locations of the USER buttons and information on USER button icons, refer to page 36.
- When still pictures are being recorded, the remaining recordable number of still pictures and the still picture indication  are displayed.

# Switching between Auto and Manual Mode

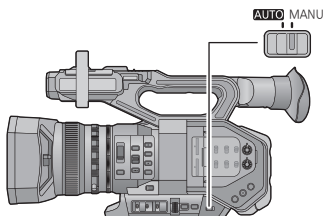

## AUTO/MANU switch

Slide the switch to change Auto Mode/Manual Mode.

- **A** is displayed in the Auto Mode.
- In Auto Mode, this unit operates according to the [AUTO SW] menu settings.

- When the following settings are automatically adjusted in Auto Mode, the corresponding Manual Mode settings are canceled:

– Focus (→ 34)

– GAIN (→ 35)

– Iris (→ 35)

– Shutter speed (→ 35)

### ■ Controls that are disabled in Auto Mode

Certain controls of this unit may be disabled in Auto Mode. Controls to be disabled vary by the [AUTO SW] menu settings.

Conditions that disable controls	Controls that are disabled in Auto Mode
[A.IRIS] is set to [ON].	Iris Ring, IRIS button
[AGC] is set to [ON].	GAIN switch, the USER button to which [SUPER GAIN] is registered
[AUTO SHUTTER] is set to [ON].	SHUTTER button
[ATW] is set to [ON].	WHITE BAL switch
[AF] is set to [ON].	Focus ring, FOCUS ASSIST button, FOCUS A/M/ $\infty$ switch, PUSH AUTO button, the USER button to which [FOCUS ASSIST 1], [FOCUS ASSIST 2], [PUSH AUTO] or [FOCUS TRANSITION] is registered





# Using the zoom

It can be zoomed up to 13×.

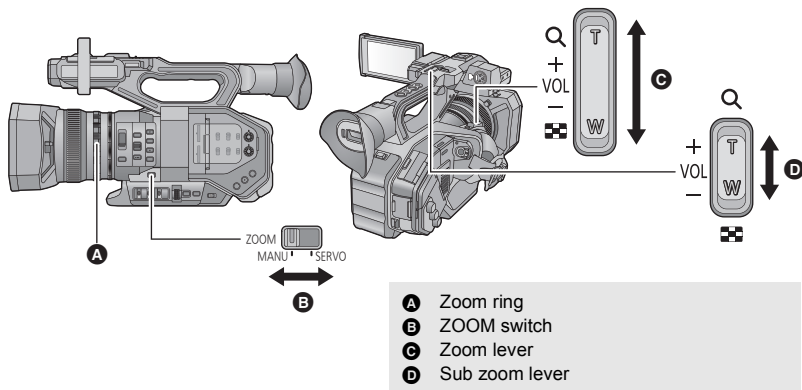

- A** Zoom ring
- B** ZOOM switch
- C** Zoom lever
- D** Sub zoom lever

## 1 Slide the ZOOM switch.

**MANU:** Zoom operation can be done using the zoom ring.

**SERVO:** Zoom operation can be done using the zoom lever/sub zoom lever.

## 2 (Set the ZOOM switch to [MANU]) Operate the zoom ring.

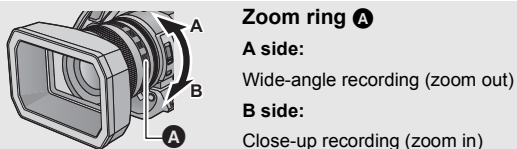

### Zoom ring **A**

**A side:**

Wide-angle recording (zoom out)

**B side:**

Close-up recording (zoom in)

(Set the ZOOM switch to [SERVO])

## Operate the zoom lever/sub zoom lever.

**T side:** Close-up recording (zoom in)

**W side:** Wide-angle recording (zoom out)

## ■ About the zoom speed

- The zoom speed will vary depending on how far the zoom lever is pressed or how fast the zoom ring is rotated.
- The zoom operation using the sub zoom lever will be performed at a constant speed. Zoom speed of the sub zoom lever will vary depending on the setting of [SUB ZOOM].



# Manual Recording

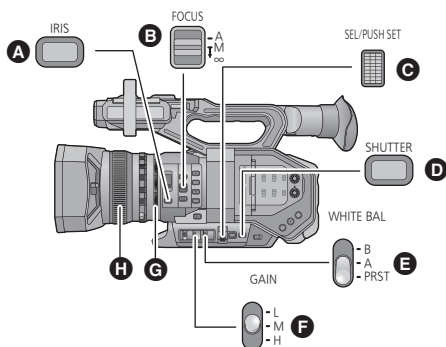

- A** IRIS button
- B** FOCUS A/M/∞ switch
- C** Jog dial
- D** SHUTTER button
- E** WHITE BAL switch
- F** GAIN switch
- G** Iris ring
- H** Focus ring

## Focus

Perform focus adjustments using the focus ring. If auto focusing is difficult due to the conditions, then use Manual Focus.

- **Switch to Manual Mode.** (→ 32)

**1** Set the **FOCUS A/M/∞** switch to **[M]** to enable **Manual Focus**.

- It will switch to MF from AF.

**2** Adjust the focus by rotating the focus ring.

## White Balance

Automatic White Balance function may not reproduce natural colors depending on the scenes or lighting conditions. If so, you can adjust the White Balance manually.

- **Register [AWB] (Auto White Balance) to a USER button.** (→ 36)
- **Switch to Manual Mode.** (→ 32)

**1** Set the **WHITE BAL** switch to **PRST**.

- The White Balance mode set in [WB PRESET] will be displayed.
- If it will switch to A or B, the White Balance mode is set to [Ach] or [Bch].

**2** Press the **USER** button to which **[AWB]** is registered or touch the applicable **USER** button icon to change the **White Balance** mode.

- The mode will change each time you press the USER button to which [AWB] is registered or touch the applicable USER button icon.  
[P3200K] → [P5600K] → [VAR]
- It is not possible to change the White Balance mode without registering [AWB] to a USER button.

## Iris/Gain adjustment

When recording a scene that is too dark (or bright) or a scene in a similar situation, manually adjust the iris and gain.

### ■ Iris adjustment

- Switch to Manual Mode. (→ 32)

- A** Iris value
- B** Auto iris icon\*

\* It is displayed in Auto Iris Mode.

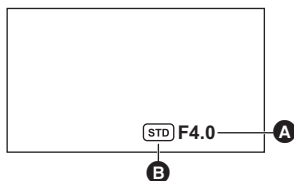

#### 1 Press the IRIS button to switch to Manual Iris Mode.

- [STD] disappears.

#### 2 Adjust the iris by rotating the iris ring.

### ■ Gain adjustment

- Use the jog dial to change the settings.
- Switch to Manual Mode. (→ 32)

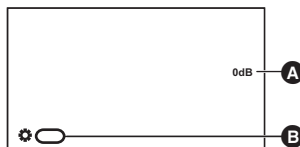

- A** Gain value

- The gain value changes depending on [GAIN/ISO DISPLAY CHG] setting:

– (When set to [GAIN])

In Auto Gain Mode, "AGC" is displayed; in Manual Gain Mode, the gain value is displayed in dB.

– (When set to [ISO])

In Auto Gain Mode, "ISO AUTO" is displayed; in Manual Gain Mode, the gain value is displayed in ISO.

- B** [GAIN]

#### 1 Slide the GAIN switch.

L: Sets the gain value to a value set in [LOW GAIN].

M: Sets the gain value to a value set in [MID GAIN].

H: Sets the gain value to a value set in [HIGH GAIN].

#### 2 Push the jog dial.



#### 3 Adjust the gain by rotating the jog dial.



## Manual shutter speed

Adjust the shutter speed when recording fast-moving subjects.

- Use the jog dial to change the settings.
- Switch to Manual Mode. (→ 32)

**1** Press the SHUTTER button to switch to Manual Shutter Mode.

**2** Adjust the shutter speed by rotating the jog dial.

Recording



## USER button

Each of the USER button can register one function from the 43 available functions.

- There are 9 USER buttons (USER1 to 8 and AWB) on the main body and 4 USER button icons (USER10 to USER13) displayed on the LCD monitor.

## Setting the USER button

**1** Select the menu. (→ 41)

MENU: [USER SW] → Name of the USER button you want to use

- USER9 corresponds to the AWB.
- It is not possible to register functions to [USER10] to [USER13] in Playback Mode.

**2** Touch the item to register.

- For the functions of the USER button that can be registered, refer to page 37.
- Touch [INHIBIT] if not registering.
- Next (Previous) page can be displayed by touching ▲ / ▼.

**3** Touch [EXIT] to complete the setting.

## Using the USER button

To use the function assigned to a USER button or USER button icon, press the applicable USER button (one of the USER buttons 1 to 8 or the AWB button), or touch the applicable USER button icon (one of the USER button icons 10 to 13) while operation icons are displayed.

(When you use the USER1 to USER7 button)

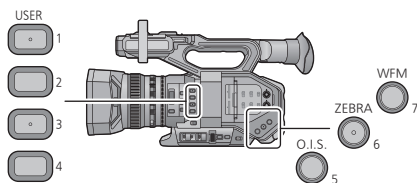

(When you use the USER8 button)

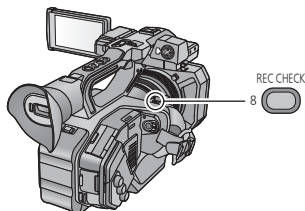

(When you use the AWB button)

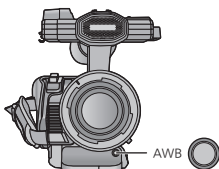

(When you use the USER10 to USER13 button)

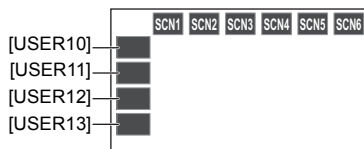

# Functions of the USER button

## ■ List of USER button functions

- Please refer to "Operating Instructions Vol.2" (PDF file) for more information about the functions of the USER button.

Item	Icon	Function
[INHIBIT]	[INH]	Invalid
[FOCUS MACRO]	[F.Macro]	Focus Macro
[BACKLIGHT]	[B.Light]	Backlight Compensation
[SPOTLIGHT]	[S.Light]	Spotlight
[BLACK FADE]	[B.FD]	Black Fade
[WHITE FADE]	[W.FD]	White Fade
[ATW]	[ATW]	Auto Tracking White Balance
[ATW LOCK]	[ATW.L]	ATW Lock
[FOCUS ASSIST 1]	[FA1]	Focus Assist1
[FOCUS ASSIST 2]	[FA2]	Focus Assist2
[REC CHECK]	[REC.C]	Recording Check
[LAST SCN DEL]	[LstDel]	Last Scene Delete
[DRS]	[DRS]	DRS
[FRZ FRAME]	[FRZ]	Freeze Frame
[SUPER GAIN]	[S.Gain]	Super Gain <sup>*1</sup>
[AREA]	[AREA]	Area Mode
[FOCUS TRANS]	[F.Tran]	Focus Transition <sup>*2</sup>
[CAPTURE]	[Capture]	Capture
[EVF/LCD DETAIL]	[DETAIL]	EVF/LCD detail
[IR REC]	[IR REC]	Infrared Recording
[LEVEL GAUGE]	[Level]	Level Gauge
[BACKGROUND]	[Backgr]	Background
[FLASH BAND]	[FBC]	Flash band compensation
[PRE-REC]	[PRE-REC]	PRE-REC
[WFM]	[WFM]	WFM
[FAST ZOOM]	[F.ZOOM]	Fast Zoom
[EVF ON/OFF]	[EVF SW]	EVF ON/OFF
[A.IRIS LEVEL]	[A.IRIS]	Auto Iris Level
[ZEBRA]	[ZEBRA]	Zebra
[O.I.S.]	[O.I.S.]	Optical Image Stabilizer

\*1 Not available in Auto Mode

\*2 Not available for Auto Focus

Item	Icon	Function
[SCENE FILE]	[SCN FILE]	Scene File
[AUTO REC]	[AutoRec]	Auto Rec
[AF AREA]	[AF Area]	AF area width adjustment
[VFR]	[VFR]	Variable Frame Rate Mode
[D.ZOOM]	[D.ZM]	Digital Zoom
[i.ZOOM]	[i.Zoom]	i.Zoom
[USB MODE]	[USB]	USB Mode*
[LOG VIEW ASSIST]	[LogView]	Log View Assist
[LCD/EVF OUTPUT]	[LCD/EVF]	LCD/EVF Output
[HISTOGRAM]	[HIST]	Histogram
[PUSH AUTO]	[PushAuto]	Push Auto
[SLOT SEL]	[SlotSel]	Slot Selection
[AWB]	[AWB]	Auto White Balance
[MENU]	[MENU]	Menu

\* Not available during AG ROP application connection.

● The following USER button function can also be set from the menu.

- [FOCUS MACRO]
- [DRS]
- [INFRARED REC]
- [LEVEL GAUGE]
- [EVF/LCD DETAIL]
- [FLASH BAND COMPENSATION]
- [PRE-REC]
- [WFM]
- [FAST ZOOM]
- [AUTO IRIS LEVEL]
- [ZEBRA]
- [O.I.S.]
- [SCENE FILE]
- [AF AREA WIDTH]
- [VFR MODE]
- [i.Zoom]
- [USB MODE]
- [LCD/EVF OUTPUT]
- [HISTOGRAM]



# Motion picture/Still picture playback

1 Set this unit to playback mode. (→ 25)

2 Touch the play mode select icon **A**.

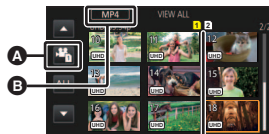

Media display

The selected media is displayed in yellow.

3 Select the media **C** you wish to play back.



4 (To set this unit to Motion Picture Playback Mode)

Touch the desired recording mode **D** and recording format **E** for playback.

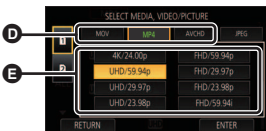

- Recording mode options with recorded scenes are displayed in green.
- The available recording format options differ depending on [SYSTEM FREQ] (→ 30) or the recording mode option you have touched.
- Touch [ENTER].
- A recording mode icon **B** will be displayed on the thumbnail display. ( **MOV** / **MP4** / **AVCHD** )
- (If you have touched the recording mode option [MOV] or [MP4])
 

After you have touched a recording format option, one of the following icons will be displayed on each thumbnail. The icon to be displayed differs depending on the size of recording format.

  - 4K** : Scenes recorded in 4K (4096×2160)
  - UHD** : Scenes recorded in UHD (3840×2160)
  - FHD** : Scenes recorded in FHD (1920×1080)
  - DUS0** : Scenes recorded as sub recordings with [DUAL CODEC REC] set to [FHD 50Mbps]
  - DU8** : Scenes recorded as sub recordings with [DUAL CODEC REC] set to [FHD 8Mbps]
- (If you have touched the recording mode option [AVCHD])
 

After you have touched a recording format option, one of the following icons will be displayed on each thumbnail.

  - PS** : Scenes recorded in [PS 1080/59.94p]/[PS 1080/50.00p]
  - PH** : Scenes recorded in [PH 1080/59.94i]/[PH 1080/23.98p]/[PH 1080/50.00i]
  - HA** : Scenes recorded in [HA 1080/59.94i]/[HA 1080/50.00i]
  - HE** : Scenes recorded in [HE 1080/59.94i]/[HE 1080/50.00i]
  - PM** : Scenes recorded in [PM 720/59.94p]/[PM 720/50.00p]
  - SA** : Scenes recorded in [SA 480/59.94i]/[SA 576/50.00i]

(To set this unit to Still Picture Playback Mode)

**Touch the still picture (JPEG) **F**.**



## 5 Touch the scene or the still picture to be played back.

- Next (Previous) page can be displayed by touching **▲** / **▼**.
- You can change the playback media by pressing the USER button to which [SLOT SEL] is registered. (→ 36)

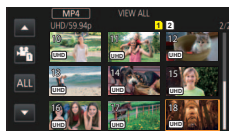

## 6 Select the playback operation by touching the operation icon.



### **G** Operation icon

- If you touch the screen while an operation icon is being displayed or do not touch the icon for a certain period, it will disappear. To display again, touch the screen.

Motion picture playback	Still picture playback
<p><b>▶/  :</b> Playback/Pause</p> <p><b>◀◀:</b> Fast rewind playback*</p> <p><b>▶▶:</b> Fast forward playback*</p> <p><b>■:</b> Stops the playback and shows the thumbnails.</p>	<p><b>▶/  :</b> Slide show (playback of the still pictures in numerical order) start/pause.</p> <p><b>◀  :</b> Plays back the previous picture.</p> <p><b>  ▶:</b> Plays back the next picture.</p> <p><b>■:</b> Stops the playback and shows the thumbnails.</p>

\* When touched twice, the fast forward/fast rewind speed increases. (Screen display will change to ◀◀ / ▶▶ .)



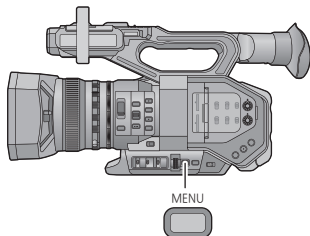

# Using the menu screen

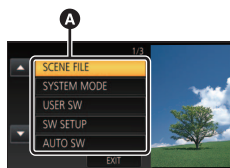

- 1 Press the MENU button .
- 2 Touch the top menu **A**.



- 3 Touch the submenu **B**.
  - Next (Previous) page can be displayed by touching  / .

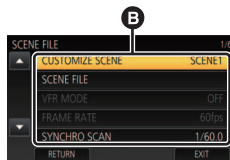

- 4 Touch the desired item to enter the setting.
- 5 Touch [EXIT] to exit the menu setting.

# Menu structure

Please refer to "Operating Instructions Vol.2" (PDF file) for details.

## ■ Menu structure in Recording mode

Scene file	[CUSTOMIZE SCENE]/[SCENE FILE]/[VFR MODE]/ [FRAME RATE]/[SYNCHRO SCAN]/[MASTER DETAIL]/ [DETAIL CORING]/[SKIN TONE DTL]/[V DETAIL LEVEL]/ [KNEE APE LEVEL]/[RB GAIN CONTROL SETTING]/ [CHROMA LEVEL]/[CHROMA PHASE]/[MATRIX]/[COLOR CORRECTION SETTING]/[MASTER PED]/[GAMMA MODE]/ [BLACK GAMMA]/[BLACK GAMMA RANGE]/[KNEE MODE]/ [KNEE MASTER POINT]/[KNEE MASTER SLOPE]/[DRS]/[DRS EFFECT]/[AUTO IRIS LEVEL]/[AUTO IRIS LEVEL EFFECT]/[V-Log L MODE]/[FLASH BAND COMPENSATION]
System mode	[SYSTEM FREQ]/[OUTPUT BITS]/[REC MODE]/[REC FORMAT]/ [OUTPUT FORMAT]/[ASPECT CONVERT]/[EXTENDED SENSITIVITY]/[HIGH SENS. MODE]/[CAMERA NUMBER SET]
User switch	[USER1]/[USER2]/[USER3]/[USER4]/[USER5]/[USER6]/[USER7]/ [USER8]/[AWB]/[USER10]/[USER11]/[USER12]/[USER BUTTON DISPLAY]
Switch setting	[IRIS RING]/[LOW GAIN]/[MID GAIN]/[HIGH GAIN]/[SUPER GAIN]/ [O.I.S.]/[HYBRID O.I.S.]/[CUSTOM O.I.S.]/[BLUR AMPLITUDE]/ [BLUR FREQUENCY]/[ATW SET]/[ATW SPEED]/ [ATW TARGET R]/[ATW TARGET B]/[WB PRESET]/[WB VAR]/[MF ASSIST]/[MF ASSIST MODE]/[FOCUS ASSIST 1]/[FOCUS ASSIST 2]/[PEAKING COLOR]/[PEAKING LEVEL]/[FOCUS RING DRIVE]/ [FOCUS MACRO]/[A.IRIS SPEED]/[AREA MODE]/[CUSTOM AF]/ [AF SPEED]/[AF SENSITIVITY]/[AF AREA WIDTH]/[WFM]/[WFM TYPE]/[WFM POSITION]/[ZEBRA]/[ZEBRA MODE]/[BARS TYPE]/ [SUB REC BUTTON]/[FAST ZOOM]/[SUB ZOOM]/[DIGITAL ZOOM]/[i.Zoom]/[ZOOM/FOCUS]
Auto switch setting	[A.IRIS]/[AGC]/[AGC LIMIT]/[AUTO SHUTTER]/[AUTO SHUTTER LIMIT]/[AUTO SLOW SHTR]/[ATW]/[AF]
Recording Setup	[MEDIA SELECT]/[2 SLOTS FUNC.]/[DUAL CODEC REC]/ [INTERVAL REC]/[PRE-REC]/[INFRARED REC]/ [FOCUS TRANSITION]/[FOCUS TRANSITION TIME]/ [FOCUS TRANSITION REC]/[FOCUS TRANSITION WAIT]/[TIME STAMP]/[DF MODE]/[TCG]/[TC PRESET]/[UB PRESET]/ [EXT TC LINK]
Audio Setup	[AUDIO LOW CUT CH1]/[AUDIO LOW CUT CH2]/[AUDIO ALC LINK]/[AUDIO ALC CH1]/[AUDIO ALC CH2]/[INPUT1 LINE LEVEL]/[INPUT2 LINE LEVEL]/[INPUT1 MIC LEVEL]/ [INPUT2 MIC LEVEL]

<b>Output Setup</b>	[OUTPUT SEL]/[RESOLUTION]/[SDI REMOTE]/ [REMOTE REC LINK]/[SDI EDH]/[SDI AUDIO GAIN CHG]/[DOWN CONV.]/[HDMI UHD OUTPUT LIMIT]/[HDMI TC OUTPUT]/ [VOLUME]/[TEST TONE]/[VIDEO SETUP]/[LCD/EVF OUTPUT]
<b>Display setting</b>	[ZEBRA DETECT 1]/[ZEBRA DETECT 2]/[MARKER]/[GUIDE LINES]/[SAFETY ZONE]/[CENTER MARKER]/[REC COUNTER]/ [SHUTTER DISPLAY CHG]/[GAIN/ISO DISPLAY CHG]/[ZOOM/ FOCUS]/[VIDEO OUT OSD]/[DATE/TIME]/[DATE FORMAT]/ [LEVEL GAUGE]/[HISTOGRAM]/[AUDIO LEVEL METER]/ [LENS STATUS]/[CARD & BATTERY]/[OTHER DISPLAY]/[LCD BACKLIGHT]/[LCD SET]/[EVF SETTING]/[EYE SENSOR]/ [SELF SHOOT]/[EVF COLOR]/[EVF/LCD DETAIL]/[EVF/ LCD PEAK LEVEL]/[EVF/LCD PEAK FREQ.]
<b>Other Functions</b>	[FORMAT MEDIA]/[MEDIA STATUS]/[REC LAMP]/[CLOCK SET]/ [TIME ZONE]/[ALERT SOUND]/[ECONOMY (BATT)]/[ECONOMY (AC)]/[USB MODE]/[USB MODE SELECT]/[INITIAL SET]/ [NUMBER RESET]/[COLOR TONE]/[LANGUAGE]
<b>Network Setup</b>	[USER ACCOUNT]/[WIRELESS SETUP]/[Wireless LAN setup]/ [CONNECTION HISTORY]/[NETWORK INITIAL SETTING]/ [NETWORK SETUP PASSWORD]
<b>Maintenance</b>	[VERSION]/[UPDATE]/[HOUR METER]

## ■ Menu structure in Playback mode

<b>Video Setup*<sup>1</sup></b>	[REPEAT PLAY]/[RESUME PLAY]/[SCENE PROTECT]/[DELETE]
<b>Picture Setup*<sup>2</sup></b>	[SCENE PROTECT]/[DELETE]
<b>Copy</b>	[COPY ONCE]/[SELECT COPY]
<b>User switch</b>	[USER1]/[USER2]/[USER3]/[USER4]/[USER5]/[USER6]/[USER7]/ [USER8]/[AWB]
<b>Output Setup</b>	[OUTPUT SEL]/[RESOLUTION]/[SDI EDH]* <sup>1</sup> /[SDI AUDIO GAIN CHG]* <sup>1</sup> /[DOWN CONV.]/[HDMI UHD OUTPUT LIMIT]/[HDMI TC OUTPUT]* <sup>1</sup> /[VIDEO SETUP]/[LCD/EVF OUTPUT]
<b>Display setting</b>	[VIDEO OUT OSD]/[DATE/TIME]/[DATE FORMAT]/[AUDIO LEVEL METER]* <sup>1</sup> /[CARD & BATTERY]/[OTHER DISPLAY]/[LCD BACKLIGHT]/[LCD SET]/[EVF SETTING]/[EYE SENSOR]/[EVF COLOR]
<b>Other Functions</b>	[FORMAT MEDIA]/[MEDIA STATUS]/[CLOCK SET]/[TIME ZONE]/ [ALERT SOUND]/[ECONOMY (BATT)]/[ECONOMY (AC)]/ [SYSTEM FREQ]/[USB MODE]/[USB MODE SELECT]/[INITIAL SET]/[NUMBER RESET]/[LANGUAGE]
<b>Network Setup</b>	[USER ACCOUNT]/[WIRELESS SETUP]/[Wireless LAN setup]/ [CONNECTION HISTORY]/[NETWORK INITIAL SETTING]/ [NETWORK SETUP PASSWORD]
<b>Maintenance</b>	[VERSION]/[UPDATE]/[HOUR METER]

\*1 The items are available in Motion Picture Playback Mode.

\*2 The items are available in Still Picture Playback Mode.

## Cautions for use

### About this unit

**The unit and the SD card become warm during use. This is not a malfunction.**

**Keep this unit as far away as possible from electromagnetic equipment (such as microwave ovens, TVs, video games etc.).**

- If you use this unit on top of or near a TV, the pictures and/or sound on this unit may be disrupted by electromagnetic wave radiation.
- Do not use this unit near cell phones because doing so may result in noise adversely affecting the pictures and/or sound.
- Recorded data may be damaged, or pictures may be distorted, by strong magnetic fields created by speakers or large motors.
- Electromagnetic wave radiation generated by microprocessors may adversely affect this unit, disturbing the pictures and/or sound.
- If this unit is adversely affected by electromagnetic equipment and stops functioning properly, turn this unit off and remove the battery or disconnect AC adaptor. Then reinsert the battery or reconnect AC adaptor and turn this unit on.

**Do not use this unit near radio transmitters or high-voltage lines.**

- If you record near radio transmitters or high-voltage lines, the recorded pictures and/or sound may be adversely affected.

**Make sure to use the supplied cords and cables. If you use optional accessories, use the cords and the cables supplied with them.**

**Do not extend the cords and the cables.**

**Do not spray insecticides or volatile chemicals onto the unit.**

- If the unit is sprayed with such chemicals, its body may be marred and the surface finish may peel off.
- Do not leave rubber or plastic products in contact with the unit for a long time.

**When you use the unit in a sandy or dusty place such as a beach, do not let sand or fine dust get into the body and terminals of the unit.**

**Also, keep the unit away from sea water.**

- Sand or dust may damage the unit. (Care should be taken when inserting and removing a card.)
- If sea water splashes onto the unit, wipe off the water with a well wrung cloth. Then wipe the unit again with a dry cloth.

**When carrying the unit, do not drop or bump it.**

- A strong impact can break the unit's casing, causing it to malfunction.
- When carrying this unit, please hold the hand strap or shoulder strap firmly and treat it with care.

### Cleaning

- Before cleaning, detach the battery or pull the AC cable from the AC outlet, and then wipe the unit with a soft, dry cloth.
- If the unit is very dirty, dip a cloth in water and squeeze firmly, and then wipe the unit with the damp cloth. Next, dry the unit with a dry cloth.
- Use of benzine, paint thinner, alcohol, or dishwashing liquid may alter the camera body or peel the surface finish. Do not use these solvents.
- When using a chemical dust cloth, follow the instructions that came with the cloth.

**When you are not going to use the unit for an extended time**

- When storing the unit, it is recommended that you place a desiccant (silica gel) in with it.

### **Do not lift up this unit by the handle with the tripod still attached**

- When the tripod is attached, its weight will also affect the unit's handle, possibly causing the handle to break and hurting the user.
- To carry the unit while the tripod is attached, take hold of the tripod.

### **Do not swing the unit around, shake it by, or allow it hang from the handle**

- Do not jar, swing, or shake the unit by its handle. Any strong jolt to the handle may damage the unit or result in personal injury.

### **Do not allow the cord to drag on the ground or pull a connected cord along the passage**

- The cord will be damaged, causing fire or electrical shock, when the cord gets caught by the feet, excite will also cause personal injury.

### **When this unit is turned on, do not use it in direct contact with the skin for a long period of time.**

- When using this unit for a long period of time, use a support such as a tripod. Low temperature burns may result if any high temperature part of this unit or hot air from the ventilation openings on the front side of the hand strap of this unit is in direct contact with the skin for a long period of time.

## **About the battery**

The battery used in this unit is a rechargeable lithium-ion battery. It is susceptible to humidity and temperature and the effect increases the more the temperature rises or falls. In cold areas, the full charge indication may not appear or the low battery indication may appear about 5 minutes after starting use. At high temperatures, the protection function may be triggered, making it impossible to use the unit.

### **Be sure to detach the battery after use.**

- If the battery is left attached, a minute amount of current continues to flow even if the unit is off. Keeping the unit in this state may result in over discharge of the battery. This may result in you not being able to use the battery even after it is charged.

- The battery should be stored in the vinyl bag so metal does not come into contact with the terminals.
- The battery should be stored in a cool place free from humidity, with as constant temperature as possible. (Recommended temperature: 15 °C to 25 °C (59 °F to 77 °F), Recommended humidity: 40%RH to 60%RH)
- Extremely high temperatures or low temperatures will shorten the life of the battery.
- If the battery is kept in high-temperature, high-humidity, or oily-smoky places, the terminals may rust and cause malfunctions.
- To store the battery for a long period of time, we recommend you charge it once every year and store it again after you have completely used up the charged capacity.
- Dust and other matter attached to the battery terminals should be removed.

### **Prepare spare batteries when going out for recording.**

- Prepare batteries enough to last for 3 to 4 times the period you are planning to record for. Cold places such as a ski resort can shorten recording time.

### **If you drop the battery accidentally, check to see if the terminals are damaged.**

- When this unit or battery charger is attached with the terminal part in a deformed state, this unit or battery charger may be damaged.

### **Do not throw old battery into fire.**

- Heating a battery or throwing it into a fire may result in an explosion.

### **If the operating time is very short even after the battery has been recharged, the battery has worn out. Please purchase a new battery.**

## About the AC adaptor/battery charger

- If the temperature of the battery is extremely high or extremely low, charging may take time or the battery may not be charged.
- If the charging lamp keeps flashing, make sure that the terminals of the battery or the battery charger are not exposed to dirt, foreign objects or dust, then reconnect them properly.  
Disconnect the AC cable from the AC outlet when you remove dirt, foreign objects or dust on the terminals of the battery or the battery charger.  
If the charging lamp is still flashing, the temperature of the battery may be extremely high or extremely low or something may be wrong with the battery or battery charger. Contact your dealer.
- If you use the AC adaptor or battery charger near a radio, radio reception may be disturbed. Keep the AC adaptor or battery charger 1 m (3.3 feet) or more away from the radio.
- When using the AC adaptor or battery charger, it may generate whirring sounds. However, this is normal.
- After use, be sure to disconnect the AC cable from the AC outlet. (If you leave this unit connected, the AC adaptor will consume approximately 0.3 W and the battery charger approximately 0.3 W of current.)
- Always keep the electrodes of the AC adaptor, battery charger and battery clean.
- **Install the device near an AC outlet so that the power disconnection device (AC mains plug) can be accessed easily by hand.**

## About the SD card

### When disposing of or giving away the SD card, note that:

- Formatting and deletion of this unit or computer only changes the file management information and does not completely delete the data in the SD card.
- It is recommended that the main SD card is either physically destroyed or the SD card is physically formatted using this unit when disposing of or giving away the SD card.
- To physically format, connect this unit to the AC adaptor, select [OTHER FUNCTION] → [FORMAT MEDIA] → [SD CARD 1] or [SD CARD 2] from the menu, and touch [YES]. Press and hold recording start/stop button in the following screen for three seconds. Screen to delete the SD card data is displayed, so select [YES] and follow the instruction on the screen.

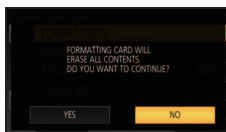

- The customer is responsible for the management of the data in the SD card.

## LCD monitor/viewfinder

- When the LCD screen is dirty or condensation has occurred, please wipe it using a soft cloth such as a lens cloth.
- Do not touch the LCD monitor with your finger nails, or rub or press with strong force.
- It may become hard to see or hard to recognize the touch when the LCD protection sheet is affixed.
- When the unit has become very cold, for example due to storage in a cold area, its LCD monitor will be slightly darker than usual immediately after the unit is turned on. The normal brightness will be restored when the unit's internal temperature rises.

Extremely high precision technology is employed to produce the LCD Monitor screen. The result is more than 99.99% effective dots with a mere 0.01% of the dots inactive or always lit. However, this is not a malfunction and does not affect the recorded picture.

Extremely high precision technology is employed to produce the viewfinder screen. The result is more than 99.99% effective dots with a mere 0.01% of the dots inactive or always lit. However, this is not a malfunction and does not affect the recorded picture.

Others

## About copyright

### ■ Carefully observe copyright laws

#### **IMPORTANT**

**“Unauthorized recording of copyrighted television programs, video tapes and other materials may infringe the right of copyright owners and be contrary to copyright laws.”**

### ■ Licenses

- SDXC Logo is a trademark of SD-3C, LLC.
- “AVCHD”, “AVCHD Progressive” and the “AVCHD Progressive” logo are trademarks of Panasonic Corporation and Sony Corporation.
- Manufactured under license from Dolby Laboratories. Dolby and the double-D symbol are trademarks of Dolby Laboratories.
- HDMI, the HDMI Logo, and High-Definition Multimedia Interface are trademarks or registered trademarks of HDMI Licensing LLC in the United States and other countries.
- LEICA is a registered trademark of Leica Microsystems IR GmbH.
- DICOMAR is a registered trademark of Leica Camera AG.

- iPad is a trademark of Apple Inc., registered in the U.S. and other countries.
- Other names of systems and products mentioned in these instructions are usually the registered trademarks or trademarks of the manufacturers who developed the system or product concerned.

---

This product is licensed under the AVC Patent Portfolio License for the personal use of a consumer or other uses in which it does not receive remuneration to (i) encode video in compliance with the AVC Standard (“AVC Video”) and/or (ii) decode AVC Video that was encoded by a consumer engaged in a personal activity and/or was obtained from a video provider licensed to provide AVC Video. No license is granted or shall be implied for any other use. Additional information may be obtained from MPEG LA, L.L.C. See <http://www.mpegla.com>

- Separate license contracts must be obtained from MPEG LA where SD Memory Cards containing information recorded with this product are to be distributed to end users for commercial purposes. “End user” refers to persons or organizations handling such contents for personal use.

---

This item incorporates copy protection technology that is protected by U.S. patents and other intellectual property rights of Rovi Corporation. Reverse engineering and disassembly are prohibited.

This product incorporates the following software:

- (1) the software developed independently by or for Panasonic Corporation,
- (2) the software owned by third party and licensed to Panasonic Corporation,
- (3) the software licensed under the GNU General Public License, Version 2.0 (GPL V2.0),
- (4) the software licensed under the GNU LESSER General Public License, Version 2.1 (LGPL V2.1), and/or
- (5) open source software other than the software licensed under the GPL V2.0 and/or LGPL V2.1.

The software categorized as (3) - (5) are distributed in the hope that it will be useful, but WITHOUT ANY WARRANTY, without even the implied warranty of MERCHANTABILITY or FITNESS FOR A PARTICULAR PURPOSE.

At least three (3) years from delivery of this product, Panasonic will give to any third party who contacts us at the contact information provided below, for a charge no more than our cost of physically performing source code distribution, a complete machine-readable copy of the corresponding source code covered under GPL V2.0 or LGPL V2.1, as well as the respective copyright notice thereof.

Contact Information: [oss-cd-request@gg.jp.panasonic.com](mailto:oss-cd-request@gg.jp.panasonic.com)

The source code and the copyright notice are also available for free in our website below.  
<https://panasonic.net/cns/oss/index.html>



# Specification

## Memory Card Camera-Recorder

### General

**Power:**

DC (===) 7.2 V (When using battery)

DC (===) 12 V (When using AC adaptor)

**Power consumption:**

21.7 W (When using LCD monitor)

 indicates safety information

**Ambient operating temperature:**

0 °C to 40 °C (32 °F to 104 °F)

**Ambient operating humidity:**

10%RH to 80%RH (no condensation)

**Mass (Weight):**

Approx. 2.7 kg (Approx. 5.95 lbs.)

[body only, excluding lens hood, battery, and accessories]

Approx. 3.1 kg (Approx. 6.80 lbs.)

[including lens hood, supplied battery, and eye cup]

**Dimensions (W×H×D):**

181 mm×216 mm×374 mm

[7-1/8"×8-1/2"×14-23/32"]

(excluding eye cup and projecting parts)

### Camera unit

**Pickup device:**

4/3-type MOS solid state image sensor

**Number of pixels:**

FHD (1920×1080): 15.49 million pixels

UHD (3840×2160) 59.94p/50.00p: 8.71 million pixels

UHD (3840×2160) 29.97p/25.00p: 12.89 million pixels

4K (4096×2160) 24P: 13.35 million pixels

**Lens:**

Optical image stabilizer lens, optical 13× motorized zoom

F value (focal length)

F2.8 to F4.5 (f=12.8 mm to 167 mm)

[1/2" to 6-9/16"]

35 mm conversion

FHD (1920×1080);

28.0 mm to 365.3 mm

[1-3/32" to 14-3/8"]

UHD (3840×2160) 59.94p/50.00p;

37.2 mm to 485.1 mm

[1-15/32" to 19-3/32"]

UHD (3840×2160) 29.97p/25.00p;

30.6 mm to 398.7 mm

[1-7/32" to 15-11/16"]

4K (4096×2160) 24p;

29.5 mm to 384.9 mm

[1-5/32" to 15-5/32"]

Filter diameter; 72 mm [2-27/32"]

ND filter; OFF, 1/4, 1/16, 1/64

Shortest shooting distance (M.O.D);

1.0 m (3.3 feet) from the lens

IR filter; incorporates the ON/OFF control function

**Gain setting:**

L/M/H selector switch

-6 dB to 24 dB (Adjustable in 1dB steps.

Negative gain values are available only when [EXTENDED SENSITIVITY] is enabled, and the automatic setting can be assigned to L/M/H.)

(When assigning [SUPER GAIN] to the USER button: The setting can be switched between 30 dB and 36 dB)

**Color temperature setting:**

[ATW], [ATW LOCK], [Ach], [Bch],

preset 3200K, preset 5600K, VAR (2000K to 15000K)

**Shutter speed:**

When [SYSTEM FREQ] = [59.94Hz]

- 60i/60p mode;  
1/60, 1/100, 1/120, 1/180, 1/250, 1/350,  
1/500, 1/750, 1/1000, 1/1500, 1/2000,  
1/3000, 1/4000, 1/8000 sec.
- 30p mode;  
1/30, 1/50, 1/60, 1/100, 1/120, 1/180, 1/250,  
1/350, 1/500, 1/750, 1/1000, 1/1500, 1/2000,  
1/3000, 1/4000, 1/8000 sec.
- 24p mode;  
1/24, 1/48, 1/50, 1/60, 1/100, 1/120, 1/180,  
1/250, 1/350, 1/500, 1/750, 1/1000, 1/1500,  
1/2000, 1/3000, 1/4000, 1/8000 sec.

When [SYSTEM FREQ] = [50.00Hz]

- 50i/50p mode;  
1/50, 1/60, 1/100, 1/125, 1/180, 1/250,  
1/350, 1/500, 1/750, 1/1000, 1/1500, 1/2000,  
1/3000, 1/4000, 1/8000 sec.
- 25p mode;  
1/25, 1/50, 1/60, 1/100, 1/125, 1/180, 1/250,  
1/350, 1/500, 1/750, 1/1000, 1/1500, 1/2000,  
1/3000, 1/4000, 1/8000 sec.

**Slow shutter speed:**

When [SYSTEM FREQ] = [59.94Hz]

- 60i/60p mode;  
1/2, 1/4, 1/8, 1/15, 1/30 sec.
- 30p mode;  
1/2, 1/4, 1/8, 1/15 sec.
- 24p mode;  
1/2, 1/3, 1/6, 1/12 sec.

When [SYSTEM FREQ] = [50.00Hz]

- 50i/50p mode;  
1/2, 1/3, 1/6, 1/12, 1/25 sec.
- 25p mode;  
1/2, 1/3, 1/6, 1/12 sec.

**Syncro scan shutter:**

When [SYSTEM FREQ] = [59.94Hz]

- 60i/60p mode;  
1/60.0 to 1/249.8 sec.
- 30p mode;  
1/30.0 to 1/249.8 sec.
- 24p mode;  
1/24.0 to 1/249.6 sec.

When [SYSTEM FREQ] = [50.00Hz]

- 50i/50p mode;  
1/50.0 to 1/250.0 sec.
- 25p mode;  
1/25.0 to 1/250.0 sec.

**Shutter open angle:**

5.0 deg to 180 deg to 360 deg  
(in 0.5 deg steps, when angle display is selected)

**VFR recording frame rate:**

When [SYSTEM FREQ] = [59.94Hz]

- 60p mode;  
2, 15, 30, 40, 55, 58, 60, 62, 65, 75, 90, 120 (fps)
- 30p mode;  
2, 15, 26, 28, 30, 32, 34, 45, 60, 75, 90, 120 (fps)
- 24p mode;  
2, 12, 18, 20, 22, 24, 26, 28, 30, 36, 48, 60,  
72, 84, 96, 120 (fps)

When [SYSTEM FREQ] = [50.00Hz]

- 50p mode;  
2, 12, 25, 33, 45, 48, 50, 52, 55, 62, 75, 100,  
120 (fps)
- 25p mode;  
2, 12, 21, 23, 25, 27, 30, 37, 50, 62, 75, 100,  
120 (fps)

**Sensitivity:**

When [HIGH SENS. MODE] = [HIGH SENS.]

F11 (2000 lx, 3200 K, 89.9% reflection, 1080/59.94i)  
F12 (2000 lx, 3200 K, 89.9% reflection, 1080/50.00i)

**Minimum subject illumination:**

0.2 lx (F2.8, gain 18 dB, shutter speed 1/2 sec., when [HIGH SENS. MODE] = [HIGH SENS.]

**Digital zoom:**

2×/5×/10×/i.Zoom (Zoom adjustable from 1.0× to 1.54×)

**Lens hood:**

Hood with lens cover

## Memory card recorder

### Recording media:

SDHC Memory Card (4 GB to 32 GB)/  
SDXC Memory Card (48 GB to 128 GB);  
UHS-I supported

Refer to page 23 for details on SD cards usable in this unit.

### Recording slots:

2 slots

### System frequency:

59.94Hz, 50.00Hz

### Motion picture recording:

Recording method; MOV, MP4, AVCHD  
Recording format;

- When [REC MODE] = [MOV], [MP4]

[4K 2160/24.00p 100M]/

[4K 2160/24.00p <sup>FastScan</sup><sub>100M</sub>];

Average 100 Mbps (VBR)

(When [SYSTEM FREQ] = [59.94Hz])

[UHD 2160/59.94p 150M];

Average 150 Mbps (VBR)

[UHD 2160/29.97p 100M]/

[UHD 2160/29.97p <sup>FastScan</sup><sub>100M</sub>]/

[UHD 2160/23.98p 100M]/

[UHD 2160/23.98p <sup>FastScan</sup><sub>100M</sub>];

Average 100 Mbps (VBR)

[FHD 1080/59.94p <sup>ALL-I</sup><sub>200M</sub>]/

[FHD 1080/29.97p <sup>ALL-I</sup><sub>200M</sub>]/

[FHD 1080/23.98p <sup>ALL-I</sup><sub>200M</sub>];

Average 200 Mbps (VBR)

[FHD 1080/59.94p 100M];

Average 100 Mbps (VBR)

[FHD 1080/59.94p 50M]/

[FHD 1080/29.97p 50M]/

[FHD 1080/23.98p 50M]/

[FHD 1080/59.94i 50M];

Average 50 Mbps (VBR)

(When [SYSTEM FREQ] set to [50.00Hz])

[UHD 2160/50.00p 150M];

Average 150 Mbps (VBR)

[UHD 2160/25.00p 100M]/

[UHD 2160/25.00p <sup>FastScan</sup><sub>100M</sub>];

Average 100 Mbps (VBR)

[FHD 1080/50.00p <sup>ALL-I</sup><sub>200M</sub>]/

[FHD 1080/25.00p <sup>ALL-I</sup><sub>200M</sub>];

Average 200 Mbps (VBR)

[FHD 1080/50.00p 100M];

Average 100 Mbps (VBR)

[FHD 1080/50.00p 50M]/

[FHD 1080/25.00p 50M]/

[FHD 1080/50.00i 50M];

Average 50 Mbps (VBR)

- When [REC MODE] = [AVCHD]

(When [SYSTEM FREQ] = [59.94Hz])

[PS 1080/59.94p]; Average 25 Mbps (VBR)

[PH 1080/59.94i]; Average 21 Mbps (VBR)

[PH 1080/23.98p]; Average 21 Mbps (VBR)

[HA 1080/59.94i]; Average 17 Mbps (VBR)

[HE 1080/59.94i]; Average 5 Mbps (VBR)

[PM 720/59.94p]; Average 8 Mbps (VBR)

[SA 480/59.94i]

(When [ASPECT CONVERT] = [SIDE

CROP], [LETTERBOX], [SQUEEZE]);

Average 9 Mbps (VBR)

(When [SYSTEM FREQ] = [50.00Hz])

[PS 1080/50.00p]; Average 25 Mbps (VBR)

[PH 1080/50.00i]; Average 21 Mbps (VBR)

[HA 1080/50.00i]; Average 17 Mbps (VBR)

[HE 1080/50.00i]; Average 5 Mbps (VBR)

[PM 720/50.00p]; Average 8 Mbps (VBR)

[SA 576/50.00i]

(When [ASPECT CONVERT] = [SIDE

CROP], [LETTERBOX], [SQUEEZE]);

Average 9 Mbps (VBR)

Refer to "Operating Instructions Vol.2" (PDF file) for the picture size and recordable time of a motion picture.

### Still picture recording:

Recording method;

JPEG corresponding DCF (Design rule for

Camera File system, based on Exif 2.2 standard)

Refer to "Operating Instructions Vol.2" (PDF

file) for picture size of a still picture and number of recordable pictures.

### 2 Slot function:

Relay, simultaneous, background\*1, dual codec

\*1 Available with a recording format of 50 Mbps or less

## Digital video

### Video signal for external output:

8bit 4:2:2/10bit 4:2:2  
(selectable menu)\*2

\*2 It is set to 8bit 4:2:0 when UHD 59.94p  
or UHD 50.00p is selected.

- Recording cannot be performed with this unit  
when 10bit 4:2:2 is selected.

### Recording video signal:

8bit 4:2:0

### Video compression format:

MPEG-4 AVC/H.264 High Profile  
(MOV/MP4/AVCHD)

## Digital audio

### Recording audio signal:

48 kHz/16bit 2CH

### Audio compression format:

Linear PCM (MOV/MP4), Dolby Digital  
(AVCHD)

### Headroom:

12 dB

## Dual codec

### Recording method:

MOV, MP4

### Video compression format:

MPEG-4 AVC/H.264 High Profile

### Audio compression format:

Linear PCM

### Recording format:

When [DUAL CODEC REC] = [FHD 50Mbps]

- For main recording  
[REC MODE] = [MOV]/[MP4]

[UHD 2160/29.97p 100M],  
[UHD 2160/29.97p<sup>FastScan</sup><sub>100M</sub>],  
[UHD 2160/25.00p 100M],  
[UHD 2160/25.00p<sup>FastScan</sup><sub>100M</sub>],  
[UHD 2160/23.98p 100M],  
[UHD 2160/23.98p<sup>FastScan</sup><sub>100M</sub>];  
Average 100 Mbps (VBR)

- For sub recording

[REC MODE] = [MOV]/[MP4]\*3  
FHD 29.97p, 25.00p, 23.98p\*4;  
Average 50 Mbps (VBR)

When [DUAL CODEC REC] = [FHD 8Mbps]

- For main recording

[REC MODE] = [MOV]/[MP4]  
[UHD 2160/29.97p 100M],

[UHD 2160/29.97p<sup>FastScan</sup><sub>100M</sub>],  
[UHD 2160/25.00p 100M],  
[UHD 2160/25.00p<sup>FastScan</sup><sub>100M</sub>],  
[UHD 2160/23.98p 100M],  
[UHD 2160/23.98p<sup>FastScan</sup><sub>100M</sub>];  
Average 100 Mbps (VBR)

[FHD 1080/59.94p<sup>ALL-I</sup><sub>200M</sub>],  
[FHD 1080/50.00p<sup>ALL-I</sup><sub>200M</sub>],  
[FHD 1080/29.97p<sup>ALL-I</sup><sub>200M</sub>],  
[FHD 1080/25.00p<sup>ALL-I</sup><sub>200M</sub>],  
[FHD 1080/23.98p<sup>ALL-I</sup><sub>200M</sub>];  
Average 200 Mbps (VBR)

[FHD 1080/59.94p 100M],  
[FHD 1080/50.00p 100M];  
Average 100 Mbps (VBR)

- For sub recording

[REC MODE] = [MOV]  
FHD 59.94p, 50.00p, 29.97p, 25.00p,  
23.98p\*4;  
Average 8 Mbps (VBR)

\*3 It records motion picture with the same  
[REC MODE] setting selected for main  
recording.

\*4 It records motion picture in the same  
frame rate as that of the  
[REC FORMAT] setting selected for  
main recording.

## Video input/output

### SDI OUT terminal:

BNC×1,  
0.8 V [p-p], 75 Ω, 3G/1.5G HD-SDI, SD-SDI  
compatible

Output format;

1080/59.94p LEVEL-A/50.00p LEVEL-A,  
1080/29.97PsF/25.00PsF/24.00PsF/  
23.98PsF, 1080/59.94i/50.00i,  
720/59.94p/50.00p, 480/59.94i, 576/50.00i

### VIDEO OUT terminal:

BNC×1,  
Composite; 1.0 V [p-p], 75 Ω

### HDMI OUT terminal:

HDMI×1,  
(HDMI Type A, not compatible with  
VIERA Link)

Output format;

2160/59.94p/50.00p/29.97p/25.00p/24.00p/  
23.98p, 1080/59.94p/50.00p/29.97p/25.00p/  
24.00p/23.98p/59.94i/50.00i,  
720/59.94p/50.00p, 480/59.94p, 576/50.00p

## Audio input

### Built-in microphone:

Supports stereo microphone

### AUDIO INPUT1/AUDIO INPUT2 terminal:

XLR×2, 3-pin

Input high impedance, LINE/MIC/MIC+48 V  
(switch selection)

- LINE; +4 dBu/0 dBu (selectable menu)
- MIC; -40 dBu /-50 dBu /-60 dBu  
(selectable menu)

## Audio output

### SDI OUT terminal:

2ch (Linear PCM)  
Gain settings; 0 dB/-6 dB/-12 dB (selectable  
menu)

### HDMI OUT terminal:

2ch (Linear PCM)

### AUDIO OUT terminal:

3.5 mm (0.14 ") diameter stereo mini jack×1  
Output level; 600 Ω, 316 mV

### Headphone output terminal:

3.5 mm (0.14 ") diameter stereo mini jack×1

### Speaker:

Round type speaker with a diameter of 20 mm  
(0.79 ") ×1

## Other input/output

### CAM REMOTE terminal:

2.5 mm (0.1 ") diameter super mini jack×1  
(ZOOM, S/S)

3.5 mm (0.14 ") diameter mini jack×1  
(FOCUS, IRIS)

### TC PRESET IN/OUT terminal:

BNC×1,  
Used as the input and output terminals

- Input; 1.0 V to 4.0 V [p-p], 10 kΩ
- Output; 2.0 V ±0.5 V [p-p], low impedance

### USB HOST terminal:

Type A connector, 9-pin, bus power supported  
In Recording mode;

USB2.0 compatible (5 V, 0.5 A)

In Playback mode;

USB 3.0 compatible (5 V, 0.9 A), used for  
external media device connection<sup>\*5</sup>

<sup>\*5</sup> External media device with a capacity  
of 32 GB or below or a capacity above  
2 TB cannot be used

### USB DEVICE terminal:

Type Micro B connector, 10-pin, USB 3.0  
compatible, used for the mass storage function  
(read only)

### DC input terminal:

DC 12 V (DC 11.4 V to 12.6 V), EIAJ type 4

## Monitor

### LCD monitor:

4.3-type HD color monitor  
(Approx. 2760000 dots)

### Viewfinder:

0.39-type OLED (organic EL display)  
(Approx. 2360000 dots, video display area;  
approx. 1770000 dots)

## AC adaptor

### Power source:

AC (～) 100 V to 240 V, 50 Hz/60 Hz  
79 VA (for AC 100 V)  
99 VA (for AC 240 V)

### Power output:

DC (＝) 12 V, 3.0 A, 36 W

 indicates safety information

### Ambient operating temperature:

0 °C to 40 °C (32 °F to 104 °F)

### Ambient operating humidity:

10%RH to 90%RH (no condensation)

### Mass (Weight):

Approx. 210 g (Approx. 0.46 lbs.)

### Dimensions (W×H×D):

115 mm×37 mm×57 mm  
[4-17/32" × 1-15/32" × 2-1/4"]  
(Excluding the DC cord portion)

## Battery charger

### Power source:

AC (～) 100 V to 240 V, 50 Hz/60 Hz  
0.4 A

### Power output:

DC (＝) 8.4 V, 1.2 A

 indicates safety information

### Ambient operating temperature:

0 °C to 40 °C (32 °F to 104 °F)

### Ambient operating humidity:

10%RH to 80%RH (no condensation)

### Mass (Weight):

Approx. 160 g (Approx. 0.35 lbs.)

### Dimensions (W×H×D):

70 mm×44.5 mm×116 mm  
[2-3/4" × 1-3/4" × 4-9/16"]



**Panasonic Corporation**  
Web site: <http://www.panasonic.com>

© Panasonic Corporation 2015