

TASCAM

LX372G0003

MZ-372

MIXER

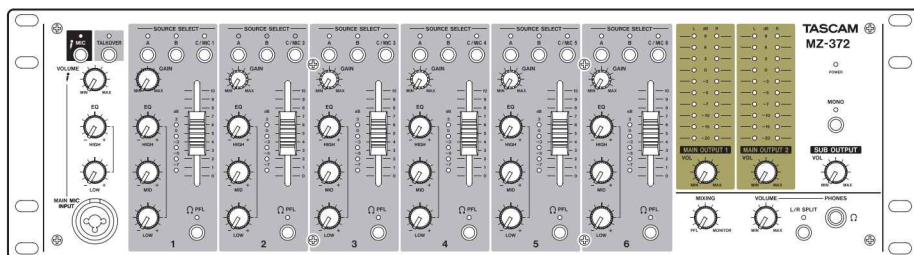

OWNER'S MANUAL

ENGLISH

MODE D'EMPLOI

FRANÇAIS

MANUAL DEL USUARIO

ESPAÑOL

BEDIENUNGSANLEITUNG

DEUTSCH

MANUALE DI ISTRUZIONI

ITALIANO

取扱説明書

日本語

- TASCAM is a trademark of TEAC CORPORATION, registered in the U.S. and other countries.
- Other company names, product names and logos in this document are the trademarks or registered trademarks of their respective owners.

TEAC CORPORATION

<https://tascam.jp/jp/>
Phone: +81-42-356-9143
1-47 Ochiai, Tama-shi, Tokyo 206-8530 Japan

TEAC AMERICA, INC.

<https://tascam.com/us/>
Phone: +1-323-726-0303
10410 Pioneer Blvd. Suite #1 and #4,
Santa Fe Springs, California 90670, U.S.A.

TEAC UK Ltd.

<https://tascam.eu/>
Phone: +44-1923-797205
Meridien House, 69-71 Clarendon Road,
Watford, Herts, WD17 1DS, United Kingdom

TEAC EUROPE GmbH





<https://tascam.de/>
Phone: +49-611-71580
Bahnstrasse 12, 65205 Wiesbaden-Erbenheim,
Germany

TEAC SALES & TRADING(SHENZHEN) CO., LTD

<http://tascam.cn/>
Phone: +86-755-88311561~2
Room 817, Xinian Center A, Tairan Nine Road West,
Shennan Road, Futian District, Shenzhen,
Guangdong Province 518040, China

OWNER'S MANUAL

IMPORTANT SAFETY PRECAUTIONS

  	CAUTION: TO REDUCE THE RISK OF ELECTRIC SHOCK, DO NOT REMOVE COVER (OR BACK). NO USER-SERVICEABLE PARTS INSIDE. REFER SERVICING TO QUALIFIED SERVICE PERSONNEL.
	The lightning flash with arrowhead symbol, within equilateral triangle, is intended to alert the user to the presence of uninsulated "dangerous voltage" within the product's enclosure that may be of sufficient magnitude to constitute a risk of electric shock to persons.
	The exclamation point within an equilateral triangle is intended to alert the user to the presence of important operating and maintenance (servicing) instructions in the literature accompanying the appliance.

WARNING: TO PREVENT FIRE OR SHOCK HAZARD, DO NOT EXPOSE THIS APPLIANCE TO RAIN OR MOISTURE.

For U.S.A.

Declaration of Conformity

Model Number: MZ-372

Trade Name: TASCAM

Responsible party: TEAC AMERICA, INC.

Address: 10410 Pioneer Blvd. Suite #1 and #4, Santa Fe Springs, California 90670, U.S.A.

Telephone number: 1-323-726-0303

This device complies with Part 15 of the FCC Rules. Operation is subject to the following two conditions: (1) this device may not cause harmful interference, and (2) this device must accept any interference received, including interference that may cause undesired operation.

INFORMATION TO THE USER

This equipment has been tested and found to comply with the limits for a Class B digital device, pursuant to Part 15 of the FCC Rules. These limits are designed to provide reasonable protection against harmful interference in a residential installation. This equipment generates, uses, and can radiate radio frequency energy and, if not installed and used in accordance with the instruction manual, may cause harmful interference to radio communications. However, there is no guarantee that interference will not occur in a particular installation. If this equipment does cause harmful interference to radio or television reception, which can be determined by turning the equipment off and on, the user is encouraged to try to correct the interference by one or more of the following measures.

- Reorient or relocate the receiving antenna.
- Increase the separation between the equipment and receiver.
- Connect the equipment into an outlet on a circuit different from that to which the receiver is connected.
- Consult the dealer or an experienced radio/TV technician for help.

CAUTION

Changes or modifications to this equipment not expressly approved by TEAC CORPORATION for compliance could void the user's authority to operate this equipment.

IN USA/CANADA, USE ONLY ON 120 V SUPPLY.

For Canada

THIS CLASS B DIGITAL APPARATUS COMPLIES WITH CANADIAN ICES-003.

CET APPAREIL NUMERIQUE DE LA CLASSE B EST CONFORME A LA NORME NMB-003 DU CANADA.



This product complies with the European Directives request and the other Commission Regulations.

CE Marking Information

EN55103-2

- Applicable electromagnetic environment: E1, E2, E3, E4

IMPORTANT SAFETY INSTRUCTIONS

1. Read these instructions.
 2. Keep these instructions.
 3. Heed all warnings.
 4. Follow all instructions.
 5. Do not use this apparatus near water.
 6. Clean only with dry cloth.
 7. Do not block any ventilation openings. Install in accordance with the manufacturer's instructions.
 8. Do not install near any heat sources such as radiators, heat registers, stoves, or other apparatus (including amplifiers) that produce heat.
 9. Do not defeat the safety purpose of the polarized or grounding-type plug. A polarized plug has two blades with one wider than the other. A grounding type plug has two blades and a third grounding prong. The wide blade or the third prong are provided for your safety. If the provided plug does not fit into your outlet, consult an electrician for replacement of the obsolete outlet.
 10. Protect the power cord from being walked on or pinched particularly at plugs, convenience receptacles, and the point where they exit from the apparatus.
 11. Only use attachments/accessories specified by the manufacturer.
 12. Use only with the cart, stand, tripod, bracket, or table specified by the manufacturer, or sold with the apparatus. When a cart is used, use caution when moving the cart/apparatus combination to avoid injury from tip-over.
 13. Unplug this apparatus during lightning storms or when unused for long periods of time.
 14. Refer all servicing to qualified service personnel. Servicing is required when the apparatus has been damaged in any way, such as power-supply cord or plug is damaged, liquid has been spilled or objects have fallen into the apparatus, the apparatus has been exposed to rain or moisture, does not operate normally, or has been dropped.
- The mains plug is used as the disconnect device, the disconnect device shall remain readily operable.
 - Caution should be taken when using earphones or headphones with the product because excessive sound pressure (volume) from earphones or headphones can cause hearing loss.
 - If you are experiencing problems with this product, contact TEAC for a service referral. Do not use the product until it has been repaired.
 - Do not remove the external cases or cabinets to expose the electronics. No user serviceable parts are inside.
 - If you are experiencing problems with this product, contact the store where you purchased the unit for a service referral. Do not use the product until it has been repaired.
 - Use of controls or adjustments or performance of procedures other than those specified herein may result in hazardous radiation exposure.

CAUTION

- Do not expose this apparatus to drips or splashes.
- Do not place any objects filled with liquids, such as vases, on the apparatus.
- Do not install this apparatus in a confined space such as a book case or similar unit.
- The apparatus should be located close enough to the AC outlet so that you can easily grasp the power cord plug at any time.
- If the product uses batteries (including a battery pack or installed batteries), they should not be exposed to sunshine, fire or excessive heat.
- CAUTION for products that use replaceable lithium batteries: there is danger of explosion if a battery is replaced with an incorrect type of battery. Replace only with the same or equivalent type.



RACK-MOUNTING THE UNIT

Use the supplied rack-mounting kit to mount the unit in a standard 19-inch rack, as shown below.

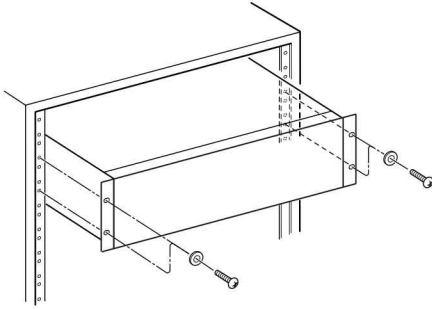

CAUTION

- Leave 1U of space above the unit for ventilation.
- Allow at least 10 cm (4 in) at the rear of the unit for ventilation.

Rack-mounting using the universal holes

To use the universal holes of this unit to mount it in a rack, install it with the rackmount screw kit as shown in the illustrations below.

Universal Hole position

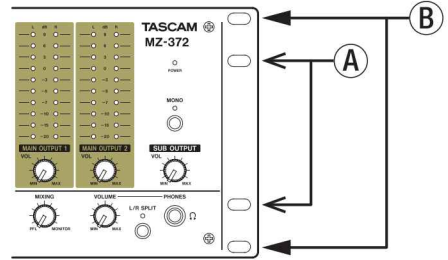

Installation in a 4U space

Use the (A) holes to mount the unit in the rack.

Installing this way creates gaps above and below the MZ-372 (C).

These gaps can be used to route cables connected to the back of the unit, for example.

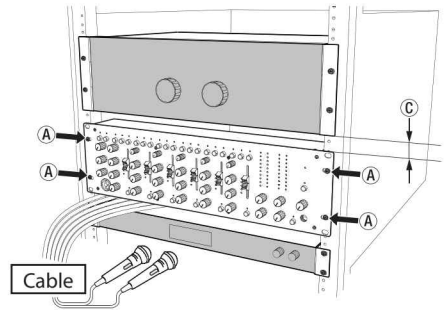

Installation in a 3U or larger space

Use the (B) holes to mount the unit in the rack.

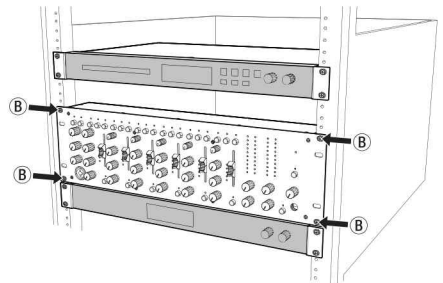

For European Customers

Disposal of electrical and electronic equipment

- (a) All electrical and electronic equipment should be disposed of separately from the municipal waste stream via designated collection facilities appointed by the government or the local authorities.
- (b) By disposing of the electrical and electronic equipment correctly, you will help save valuable resources and prevent any potential negative effects on human health and the environment.
- (c) Improper disposal of waste equipment can have serious effects on the environment and human health as a result of the presence of hazardous substances in electrical and electronic equipment.
- (d) The crossed out wheeled dust bin symbol indicates that electrical and electronic equipment must be collected and disposed of separately from household waste.
- (e) The return and collection systems are available to the end users. For more detailed information about disposal of old electrical and electronic equipment, please contact your city office, waste disposal service or the shop where you purchased the equipment.



For China



“仅适用于海拔2000m 以下地区安全使用”



“仅适用于非热带气候条件下安全使用”



“环境保护使用年限”

产品有毒有害物质或元素的名称及含量

机种: MZ-372		有毒有害物质或元素					
	品名	铅 (Pb)	汞 (Hg)	镉 (Cd)	六价铬 (Cr6+)	多溴联苯 (PBB)	多溴二苯醚 (PBDE)
1	CHASSIS 部份	○	○	○	○	○	○
2	FRONT PANEL 部份	○	○	○	○	○	○
3	螺丝部份	○	○	○	○	○	○
4	线材部份	○	○	○	○	○	○
5	PCB Assy 部份	×	○	○	○	○	○
6	电源部份	○	○	○	○	○	○
7	附属品部份	×	○	○	○	○	○
8	LABEL 部份	○	○	○	○	○	○
9	包装部份	○	○	○	○	○	○

○：表示该有毒有害物质在该部件所有均质材料中的含量均在 GB/T26572 标准规定的限量要求以下。

×：表示该有毒有害物质至少在该部件的某一均质材料中的含量超出 GB/T26572 标准规定的限量要求。
(针对现在代替技术困难的电子部品及合金中的铅))

Contents

IMPORTANT SAFETY PRECAUTIONS	3
IMPORTANT SAFETY INSTRUCTIONS	4
Features	7
Items included with this product	7
Conventions used in this manual	8
Precautions for placement and use	8
Beware of condensation	8
Cleaning the unit	8
Using the TEAC Global Site	8
Product registration	8
About TASCAM customer support service	8
Names and functions of parts	9
Front panel	9
Rear panel	10
Preparation	11
Connecting the power	11
Attaching the cord.....	11
Connecting other equipment.....	12
Turning the power on and off.....	13
Operation procedures	14
Adjusting mic input channels (1-6).....	14
Adjusting line input channels (1-6)	14
Adjusting the input of a mic connected to the MAIN MIC INPUT jack.....	14
Output channels.....	14
Using the talkover function	15
Listening to channel pre-fader signals.....	15
Troubleshooting	15
Specifications	16
Audio inputs.....	16
Audio outputs	16
Audio performance	16
General.....	17
Dimensional drawings.....	17
Block diagram.....	18

Thank you very much for purchasing the TASCAM MZ-372.

Before using this unit, read this Owner's Manual carefully so that you will be able to use it correctly and enjoy working with it for many years. After you have finished reading this manual, please keep it in a safe place for future reference.

You can also download this Owner's Manual from the TEAC Global Site (<http://teac-global.com/>).

Features

- Rackmount mixer with numerous input channels and two pairs of main outputs
 - Six input channels are equipped with gain controls, LED level meters, three-band equalizers and faders Mic or line input can be easily selected with switches
 - Independent front mic input with volume control and two-band equalizer
 - Talkover function automatically lowers background music volume according to mic volume
 - Two main outputs with stereo LED level meters
 - Sub output with volume control and mono/stereo output format selection
 - Headphone output with volume control can be used for pre-fader monitoring of selected input channels and the main output
 - 3U rackmount size
-

Items included with this product

This product includes the following items.

Take care when opening the package to avoid damaging the items. Keep the packing materials for transportation in the future.

Please contact the store where you purchased this unit if any of these items are missing or have been damaged during transportation.

- Main unit..... × 1
- AC adapter (TASCAM PS-M1524)..... × 1
- Cord for AC adapter (JAPAN USA/EUROPE)..... × 2
- Rackmount screw kit..... × 1
- Owner's Manual (this document)
including warranty..... × 1

CAUTION

Always use the included AC adapter (TASCAM PS-M1524) when using this unit. Never use the included AC adapter with any other device. Doing so could cause damage, fire or electric shock.

Conventions used in this manual

In this manual, we use the following conventions:

- The names of switches, connectors and other physical parts of this unit are written using a bold font like this: **POWER** switch.
- Additional information is provided as necessary as tips, notes and cautions.

TIP

These are tips about how to use the unit.

NOTE

These provide additional explanations and describe special cases.

CAUTION

Failure to follow these instructions could result in injury, damage to equipment or lost recording data, for example.

Precautions for placement and use

- The operating temperature range of this unit is 5–35 °C.
- Do not install this unit in the following types of locations. Doing so could cause malfunction.
 - Places with significant vibrations
 - Near windows or other places exposed to direct sunlight
 - Near heaters or other extremely hot places
 - Extremely cold places
 - Places with bad ventilation or high humidity
 - Very dusty locations
- To enable good heat dissipation, do not place anything on top of the unit.
- Do not place the unit on top of a power amplifier or other device that generates heat.

Beware of condensation

If the unit is moved from a cold to a warm place, or used after a sudden temperature change, there is a danger of condensation; vapor in the air could condense on the internal mechanism, making correct operation impossible.

To prevent this, or if this occurs, let the unit sit for one or two hours at the new room temperature before using it.

Cleaning the unit

To clean the unit, wipe it gently with a soft dry cloth. Do not wipe with chemical cleaning cloths, benzene, thinner, alcohol or other chemical agents. Doing so could damage the surface or cause discoloration.

Using the TEAC Global Site

You can download updates for this unit from the TEAC Global Site:

<http://teac-global.com/>

In the TASCAM Downloads section, select the desired language to open the Downloads website page for that language.

Product registration

Customers in the USA, please visit the following TASCAM website to register your TASCAM product online.

<https://tascam.com/us/>

About TASCAM customer support service

TASCAM products are supported and warrantied only in their country/region of purchase.

To receive support after purchase, on the TASCAM Distributors list page of the TEAC Global Site (<http://teac-global.com/>), search for the local company or representative for the region where you purchased the product and contact that organization.

When making inquiries, the address (URL) of the shop or web shop where it was purchased and the purchase date are required.

Moreover, the warranty card and proof of purchase might also be necessary.

Names and functions of parts

Front panel

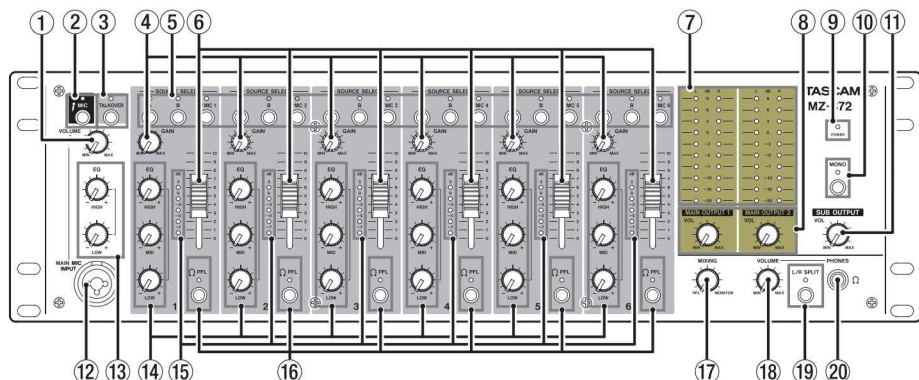

① MAIN MIC INPUT VOLUME knob

Use to adjust the mic input level from the **MAIN MIC INPUT** jack (12).

② MAIN MIC switch and indicator

Press to turn mic input from the **MAIN MIC INPUT** jack (12) on/off.

The **MIC** indicator lights when mic input is on.

③ TALKOVER switch/indicator

Press to turn the talkover function on/off.

When the talkover function is on, the **TALKOVER** indicator lights, and the levels of all input channels are lowered automatically when sound is input from a mic connected to the **MAIN MIC INPUT**.

④ GAIN knobs

Use these to adjust the levels of each input channel.

⑤ SOURCE SELECT switches/indicators

Use these to set the input source to the **C (MONO) /MIC** (26) or **LINE A/B** (34) input jacks on the back of the unit.

The indicator for the selected input lights.

⑥ Channel faders

Use these to adjust the send levels of channel signals.

⑦ Output level indicators

These indicators show the output levels of the **MAIN OUTPUTS 1-2 (UNBALANCED)** (24) jacks and **MAIN OUTPUTS 1-2 (BALANCED)** (33) jacks on the back of the unit.

⑧ MAIN OUTPUT VOL knobs

These adjust the output levels of the **MAIN OUTPUTS 1-2 (UNBALANCED)** (24) and **MAIN OUTPUTS 1-2 (BALANCED)** (33) jacks on the back of the unit.

⑨ POWER indicator

This shows the status of the unit.

When the **POWER** (21) switch on the back of the unit is on, the **POWER** indicator lights.

⑩ MONO switch/indicator

When the **MONO** switch is on (**MONO** indicator lit), mono signals will be output from the stereo output buses (**MAIN OUTPUT 1/2**, **SUB OUTPUT**, **MONITOR OUT**).

⑪ SUB OUTPUT VOL knob

Use to adjust the output level of the **SUB OUTPUT** jacks (32) on the back of the unit.

⑫ MAIN MIC INPUT jack

This is an XLR/TRS combo jack for mic input.

Use the **MAIN MIC INPUT VOLUME** knob (1) to set the input level.

⑬ MAIN MIC INPUT EQ knobs

This is a 2-band equalizer (HIGH/LOW) for the mic input sound.

⑭ INPUTS EQ knobs

Use this 3-band equalizer (HIGH/MID/LOW) to adjust the sound from the **C (MONO) /MIC** (26) input jack or **LINE A** or **B** (34) input jacks on the back of the unit.

⑮ Channel level meters

These indicators show the input levels of input channels.

16 PFL switches/indicators

- When a **PFL** switch is on (**PFL** indicator lit), the pre-fader signal (signal before fader adjustment) can be monitored through headphones.
- When a **PFL** switch is off, only the normal monitoring sound is output.

17 MIXING knob

Use this to mix the pre-fader and monitoring signals output to the headphones.

- Turn all the way to the **PFL** side to monitor channels that have their **PFL** (16) switches pressed in.
- Turn all the way to the **MONITOR** side to monitor the monitoring signal.

18 PHONES VOLUME knob

Use this to adjust the headphone output level.

19 L/R SPLIT switch/indicator

Press to change the headphone output mode.

- When the **L/R SPLIT** switch is on (indicator lit), pre-fader signals are output from the left channel and the monitoring signal is output from the right channel.
- When the **L/R SPLIT** switch is off (indicator unlit), the monitoring signal is output. When **PFL** switches are on, the pre-fader and monitoring signals are mixed and output together.

NOTE

The PFL signals are mixed with the monitoring signal, so the selected PFL signals will sound louder.

20 PHONES jack

Use this standard stereo jack to connect stereo headphones.

Use an adapter to connect headphones with a mini plug.

The monitoring and PFL signals can be monitored, depending on the **PFL** (16) and **L/R SPLIT** (19) switch settings.

Rear panel

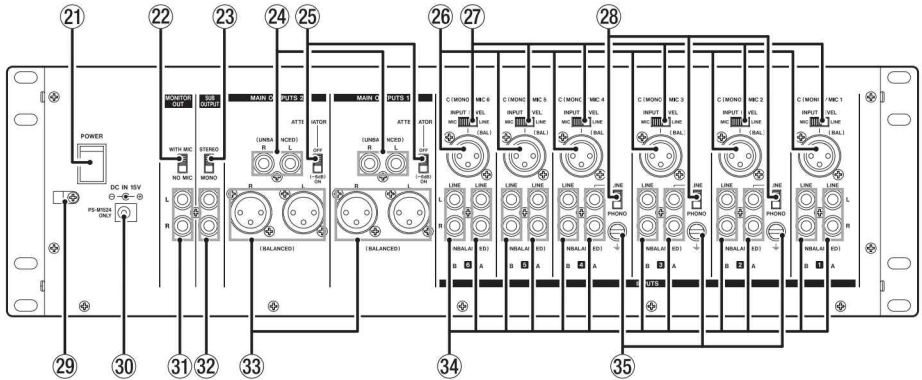

21 POWER switch

Press to turn the unit on and off. When on, the **POWER** (9) indicator lights on the front of the unit.

22 MONITOR OUT mic mix switch

This sets whether or not the input signal from a mic connected to the **MAIN MIC INPUT** (12) jack on the front of the unit is sent to and mixed with the monitoring output.

To mix the input signal from a mic connected to the **MAIN MIC INPUT** (12) jack with the monitoring output, set the **MONITOR OUT** mic mix switch to **WITH MIC**.

23 SUB OUTPUT switch

Set whether the output from the **SUB OUTPUT** (32) jacks is stereo or mono. Set it to **MONO** for mono output.

24 MAIN OUTPUTS 1-2 (UNBALANCED) jacks

These analog outputs are RCA pin jacks. Use the **ATTENUATOR** (25) switch to change the output level.

25 ATTENUATOR switches

These switch the output levels from the **MAIN OUTPUTS 1-2 (UNBALANCED)** (24) and **MAIN OUTPUTS 1-2 (BALANCED)** (33) jacks. Set them to **OFF** if the destination amplifier receives high gain, and set it to **ON (-6dB)** if the destination amplifier receives low gain.

26 C (MONO) /MIC input jacks

These are analog XLR input jacks (1: GND, 2: HOT, 3: COLD).

Their input gains can be adjusted using the **GAIN** (4) knobs on the front of the unit.

27 INPUT LEVEL switches

Use these to set the input levels of the input sources (mic or line) connected to the **C (MONO) / MIC** (26) input jacks.

Set to **MIC** for mic level signals, and set to **LINE** for line level signals.

28 LINE/PHONO input selection switches

For channels 2–4, if the output of a CD player or similar device is connected to a **LINE A** input (34) jack, set this to **LINE**. If a record player output is connected, set it to **PHONO**.

29 Cord holder

Attach the power cord of the included AC adapter (TASCAM PS-M1524) here to prevent accidental disconnection. (See “Attaching the cord” on page 11.)

30 DC IN 15V connector

Connect the included AC adapter (TASCAM PS-M1524) here.

31 MONITOR OUT jacks

These RCA pin jacks are analog monitoring outputs.

32 SUB OUTPUT jacks

These RCA pin jacks are analog outputs.

Mono signals will be output if the **SUB OUTPUT** (23) switch is set to **MONO**.

33 MAIN OUTPUTS 1-2 (BALANCED) jacks

These analog outputs are XLR jacks. (1: GND, 2: HOT, 3: COLD)

Use the **ATTENUATOR** (25) switches to change the output levels.

34 LINE A/B input jacks

These RCA pin jacks are analog line outputs.

Record players can be connected to the **LINE A** input jacks of channels 2–4. When connecting a record player to these jacks, also connect its grounding wire to the \perp (GND) jack (35), and set the **LINE/PHONO** input selection switch (28) to **PHONO**.

35 \perp (GND) connectors

If a record player is connected to the **LINE A** input (34) jacks of channel 2–4, also connect its grounding wire to this.

NOTE

If a humming noise occurs when connecting a device other than a record player, connecting a grounding wire from the metal frame of that device (or the rack frame if rackmounted) to this could reduce the noise.

Preparation

Connecting the power

Use the included AC adapter (TASCAM PS-M1524) to connect a power supply to the unit as shown below.

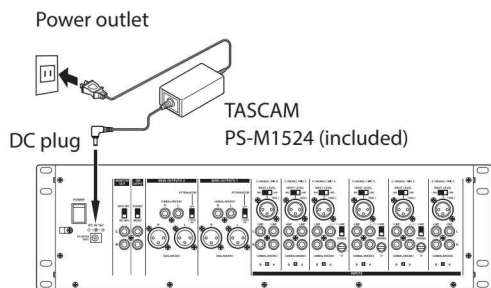

CAUTION

Always use the AC adapter (TASCAM PS-M1524) that was packaged with the unit. Using a different AC adapter could cause malfunction, overheating, fire or other problems.

NOTE

The AC adapter for the unit includes two types of adapter cords. Attach the type of AC adapter cord that matches the power outlet that you are using.

Attaching the cord

In order to prevent the cord from becoming disconnected during use, attach it to the cord holder (29) when connecting it to the unit.

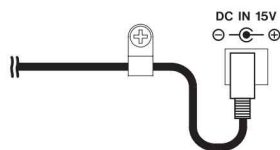

1. Remove the cord holder (29) screw.
2. Place the cord in the cord holder (29).
3. Tighten the cord holder (29) screw.

Connecting other equipment

This is an example of MZ-372 connections.

Precautions before making connections

- Carefully read the operation manuals of the devices to be connected and then connect them correctly.
- Before making connections, turn this unit and all equipment to be connected off (standby).
- Install all connected devices, including this unit, so that they are powered from the same line. When using a power strip or similar device, be sure to use one that has high current capacity (thick cable) in order to minimize fluctuations in power voltage.
- When connecting audio devices, minimize the channel 1–6 **GAIN** (4) knobs and faders (6), and the **MAIN OUTPUT VOL** (8), **SUB OUTPUT VOL** (11) and **PHONES VOLUME** (18) knobs. Failure to do so could cause sudden loud noises from monitoring equipment, and this could damage the equipment or harm hearing.

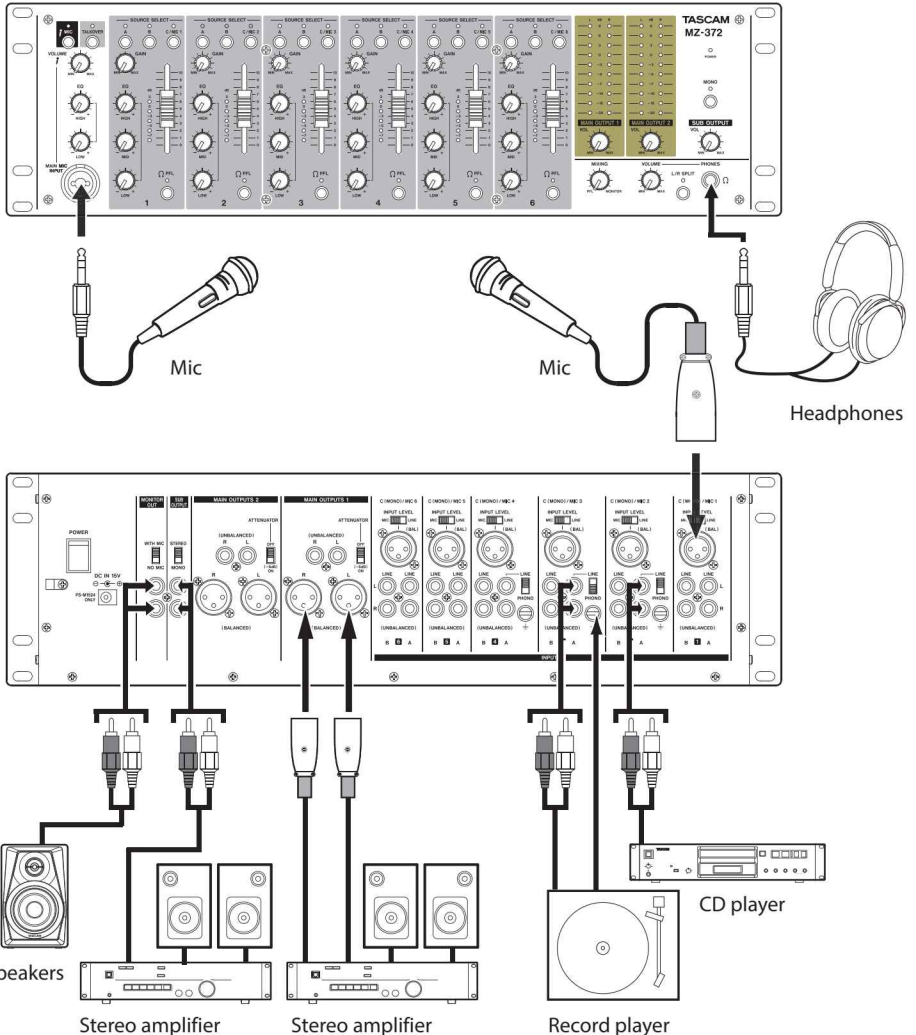

Examples of connections to an MZ-372

Connecting microphones

Mics can be connected to the **MAIN MIC INPUT** (12) jack on the front of the unit or to one of the channel 1–6 **C (MONO) / MIC** (26) input jacks on the back of the unit with the **INPUT LEVEL** (27) switch set to **MIC**.

Connecting electronic devices and other audio equipment

When connecting an electronic device or other audio equipment, connect it to channel 1–6 **C (MONO) / MIC** (26) input jacks, and set the **INPUT LEVEL** switch (27) to **LINE**. The device can be connected to channel 1–6 **LINE A** or **B** (34) input jacks.

When connected to channel 2–4 **LINE A** (34) input jacks, set the **LINE/PHONO** (28) input switch to **LINE**.

NOTE

The **C (MONO) / MIC** (26) jacks are mono inputs.

Connecting record players

When connecting a record player, connect it to channel 2–4 **LINE A** (34) input jacks, and set the **LINE/PHONO** (28) input switch to **PHONO**.

Connect the grounding wire from the record player to the \perp (GND) (35) connector.

Connecting monitor speakers

Connect monitor speakers (powered speakers or an amplifier and speaker system) to the **MONITOR OUT** (31) jacks.

To mix in the mic input signal from the **MAIN MIC INPUT** (12) jack, and output it from the monitor speakers, set the **MONITOR OUT** (22) mic mix switch to **WITH MIC**.

Connecting headphones

Connect headphones to the **PHONES** (20) jack (standard stereo).

You can monitor input channel pre-fader signals and the signal before it is sent to the stereo output bus.

CAUTION

Before connecting headphones, minimize the volume with the **PHONES VOLUME** (18) knob. Failure to do so could result in a sudden loud noise that could harm hearing, for example.

NOTE

Since the headphone sound is output from the monitoring bus, the position of the **MAIN OUTPUT VOL** (8) knob has no effect on it.

Connecting stereo amplifiers

When connecting a stereo amplifier, connect it to the **MAIN OUTPUTS 1-2 (UNBALANCED)** (24) or **MAIN OUTPUTS 1-2 (BALANCED)** (33) jacks.

TIP

- When connecting 2 or more amplifier and speaker systems, including main and sub, main and monitoring, or front and rear combinations, using the **MAIN OUTPUTS 1-2 (UNBALANCED)** (24), **MAIN OUTPUTS 1-2 (BALANCED)** (33), and **SUB OUTPUT** (32) jacks could be convenient. Moreover, the outputs of the jacks are independent and have their own dedicated output knobs, so you can set the output levels separately with this unit.
- By connecting a recorder to **MONITOR OUT** (31) jacks, the signal output to amplifier/speaker systems can be recorded.

Turning the power on and off

CAUTION

- Turn down the volume of the sound system connected to the unit before starting up or shutting down the unit.
- Do not wear connected headphones when turning the unit on and off. Loud noises could damage the speakers or harm your hearing.

Before turning the power on

1. Make the following settings on the front of the unit.
 - EQ knobs → center values
 - Other knobs → all the way left (**MIN** side)
 - Faders → all the way down
 - Switches → off (not pushed in)
2. Minimize the output levels of audio sources and input levels of amplifiers connected to this unit.

Turning the power on

1. Use the **POWER** (21) switch on the back of the unit to turn its power on.
The **POWER** (9) indicator on the front of the unit will light when on.
2. Turn connected input audio source devices on.
3. Finally turn amplifiers on.

Turning the power off

Follow the procedures above in reverse when turning the power off.

Failure to follow the correct order could result in clicking noises, for example, that might damage equipment.

Operation procedures

After turning the power on, adjust the levels of the input signals.

Adjusting mic input channels (1-6)

1. Set the channel 1-6 **GAIN** (④) and **EQ** (⑭) knobs to their center values.
2. Press the channel 1-6 **SOURCE SELECT** (⑤) **C/MIC** switches so the **C/MIC** indicators (②) light.
3. When connecting a mic to a channel 1-6 **C (MONO) /MIC** (⑳) input jack, set the **INPUT LEVEL** switch (㉗) to **MIC**.
4. Set the **MAIN OUTPUT VOL** (⑧) knob levels low.
5. Try speaking into the mic.
Use the channel 1-6 **GAIN** (④) knob to adjust the input level so that its level meter (⑮) lights around **0 dB**.
6. Use the channel 1-6 **EQ** (⑭) knobs to adjust the equalizer.
7. Follow the above procedures for other input channels with connected mics.

Adjusting line input channels (1-6)

1. Set the channel 1-6 **GAIN** (④) and **EQ** (⑭) knobs to their center values.
2. When connecting an audio device to channel 1-6, press the **SOURCE SELECT** switch (⑤), so that the **SOURCE SELECT** indicator (**A/B/C/MIC**) lights.
3. When connecting an audio device to a channel 1-6 **C (MONO) /MIC** (⑳) input jack, set the **INPUT LEVEL** switch (㉗) to **LINE**.
When connecting an audio device to channel 1-6 **LINE A/B** (㉖) input jacks, set the **LINE/PHONE** switch (㉘) to **LINE**.
4. Set the **MAIN OUTPUT VOL** (⑧) knob levels low.
5. Start playback on the connected audio device.
Use the channel 1-6 **GAIN** (④) knob to adjust the input level so that its level meter (⑮) lights around **0 dB**.
6. Use the channel 1-6 **EQ** (⑭) knobs to adjust the equalizer.
7. Follow the above procedures to adjust other input channels with connected audio devices.

Adjusting the input of a mic connected to the MAIN MIC INPUT jack

1. Connect a mic to the **MAIN MIC INPUT** jack (⑫), and press the **MAIN MIC** (②) switch so the **MAIN MIC** (②) indicator lights.
2. Use the **MAIN MIC INPUT VOLUME** (①) knob to adjust the mic input level.
3. Use the **MAIN MIC INPUT EQ** (⑬) knobs to adjust the 2-band (HIGH/LOW) equalizer for the mic sound.

Output channels

Output signals can be sent to the following jacks from the stereo output bus.

- **MAIN OUTPUTS 1-2 (UNBALANCED)** (㉔) and **MAIN OUTPUTS 1-2 (BALANCED)** (㉓) jacks
- **SUB OUTPUT** (㉚) jacks
- **MONITOR OUT** (㉑) jacks

NOTE

The output level from the **MONITOR OUT** (㉑) jacks cannot be adjusted.

Adjusting the levels output from the MAIN OUTPUTS 1-2 (UNBALANCED) and MAIN OUTPUTS 1-2 (BALANCED) jacks

While checking the output level indicators (⑦), use the channel faders (⑥) and **MAIN OUTPUT VOL** (⑧) knobs to adjust the output levels. The optimal output level adjustment is usually when the output level indicators (⑦) light around 0 dB.

When an amplifier is connected to the **MAIN OUTPUTS 1-2 (UNBALANCED)** (㉔) or **MAIN OUTPUTS 1-2 (BALANCED)** (㉓) jacks, set the **ATTENUATOR** (㉕) switch to **OFF** if it accepts high gain or **ON (-6dB)** if it accepts low gain.

Adjusting the level output from the SUB OUTPUT jacks

Use the **SUB OUTPUT VOL** (⑪) knob to adjust the output level.

If the **MONO** (⑩) switch is set to ON (**MONO** indicator lit) mono signals will be output from all output jacks. To output mono signals from only the **SUB OUTPUT** (㉚) jacks, set the **SUB OUTPUT** (㉚) switch to **MONO**.

Using the talkover function

When the talkover function is turned on by pressing the **TALKOVER** (3) switch, the levels of channels 1–6 will be automatically lowered when sound is input from a mic connected to the **MAIN MIC INPUT** (12) jack, making the mic signal easier to hear.

To turn the talkover function off, press the **TALKOVER** (3) switch to turn it off (**TALKOVER** (3) indicator becomes unlit).

Listening to channel pre-fader signals

By pressing the **PFL** (16) switches of channels to turn them on, you can enable headphone monitoring of individual channels 1–6, even when their faders (6) are set at minimum values.

You can also monitor the signal before it is sent to the stereo output bus.

1. Press the **PFL** (16) switches for the channels you want to monitor so that their **PFL** indicators light, and turn the **MIXING** (17) knob to **PFL**.

To monitor the signal before it is sent to the stereo output bus, turn the **MIXING** (17) knob to **MONITOR**.

2. After making mixing adjustments, use the **PHONES VOLUME** (18) knob to adjust the monitoring output level.

NOTE

- The **L/R SPLIT** (19) switch can be turned on/off to change the headphone output mode.
- When the **L/R SPLIT** switch (19) is on (indicator lit), the pre-fader signals are output from the left channel and the monitoring signal is output from the right channel.
- When the **L/R SPLIT** switch (19) is off (indicator unlit), the pre-fader signals and the monitoring signal are mixed and output together from both headphone channels.
- When the **PFL** (16) switch is off, if the **L/R SPLIT** (19) switch is set to on, the monitoring signal will be output from the right channel and no sound will be output from the left channel of the headphones.

Troubleshooting

If you are having trouble with the operation of this unit, please try the following before seeking repair. If these measures do not solve the problem, please contact the store where you purchased this unit or TASCAM customer support service.

The unit will not turn on.

- Confirm that the AC adapter (TASCAM PS-M1524) is securely connected to both the outlet and the DC jack.

Sound is not output from speakers connected via the MAIN OUTPUTS 1-2 jacks.

- Check the settings and volume of the connected amplifier.
- Confirm that channel faders (6) are raised.
- Confirm that the input sound source is connected properly.

The volume is low even when faders are raised.

- Confirm that the **GAIN** (4) knobs for channels 1–6 are set properly.
- If mics are being input on channels 1–6, confirm that the **INPUT LEVEL** (27) switches are set to **LINE**.

The sound is distorted.

- Confirm that the **GAIN** (4) knobs for channels 1–6 are set properly.
- Confirm that the EQ is not set too high.
- Confirm that the channel 1–6 (6) faders and **MAIN OUTPUT VOL** (8) knob are not set too high.

Sound from a record player is strange.

- Confirm that it is connected to channel 2–4 **LINE A** (34) input jacks and the **LINE/PHONO** (28) input switch is set to **PHONO**.
- Confirm that the grounding wire from the record player is connected to the \perp (GND) (35) connector.

A connected device is making a humming noise.

- Connect a grounding wire from the metal frame of the connected device to the \perp (GND) (35) connector on this unit.

No sound is output from the monitoring system connected to the MONITOR OUT jacks.

- Check the settings of the connected monitoring system.
- Confirm that the channel 1–6 **GAIN** (4) knobs and channel faders (6) are raised.

Specifications

Audio inputs

MAIN MIC INPUT (BALANCED) jacks

Connectors:

XLR-3-31 (1: GND, 2: HOT, 3: COLD)

6.3mm (1/4") standard TRS jacks (Tip: HOT,
Ring: COLD, Sleeve: GND)

Input impedance: 33 k Ω

Nominal input level: -65 dBu

(**VOLUME** knob at **MAX**)

Nominal input level: -30 dBu

(**VOLUME** knob at **MIN**)

INPUTS: MIC (BALANCED) jacks

Connectors: XLR-3-31 (1: GND, 2: HOT, 3: COLD)

Set to MIC

Maximum input level: -30 dBu

Minimum input level: -65 dBu

Input impedance: 33 k Ω

Set to LINE (UNBALANCED)

Nominal input level: -1 dBu

Maximum input level: 20 dBu

Input impedance: 22 k Ω

INPUTS: LINE (UNBALANCED) jacks

Connectors: RCA pin jacks

Nominal input level: -10 dBV

Maximum input level: 10 dBV

Input impedance: 22 k Ω

- 0 dBu=0.775 Vrms, 0 dBV=1 V

Audio outputs

MAIN OUTPUTS (UNBALANCED) jacks

Connectors: RCA pin jacks

Rated output level: -10 dBV

Maximum output level: 10 dBV

Output impedance: 200 Ω

MAIN OUTPUTS (BALANCED) jacks

Connectors: XLR-3-32 (1: GND, 2: HOT, 3: COLD)

Rated output level: 4 dBu

Maximum output level: 24 dBu

Output impedance: 200 Ω

SUB OUTPUT connectors

Connectors: RCA pin jacks

Rated output level: -16 dBV

Maximum output level: 0 dBV

Output impedance: 200 Ω

MONITOR OUT jacks

Connectors: RCA pin jacks

Rated output level: -16 dBV

Maximum output level: 0 dBV

Output impedance: 200 Ω

PHONES jack

Connectors: 6.3mm (1/4") standard stereo jack

Maximum output: 50 mW + 50 mW
(into 32 Ω load)

- 0 dBu=0.775 Vrms, 0 dBV=1 V

Audio performance

Frequency response

20 Hz–20 kHz (INPUTS LINE to MAIN OUTPUTS)

Distortion

0.03% or less (INPUTS LINE to MAIN OUTPUTS)

S/N ratio

80 dB or more (INPUTS LINE to MAIN OUTPUTS)

Crosstalk

65 dB or more (INPUTS LINE to MAIN OUTPUTS)

General

Power

Dedicated AC adapter (TASCAM PS-M1524)
Input voltage: AC 100–240V ~, 50/60Hz
Output voltage: DC 15V $\overline{\text{---}}$
Output current: 2.4 A

Power consumption

35 W

Dimensions

482.0 × 132.0 × 93.2 mm (width × height × depth, including protrusions)

Weight

3.2 kg

Dimensional drawings

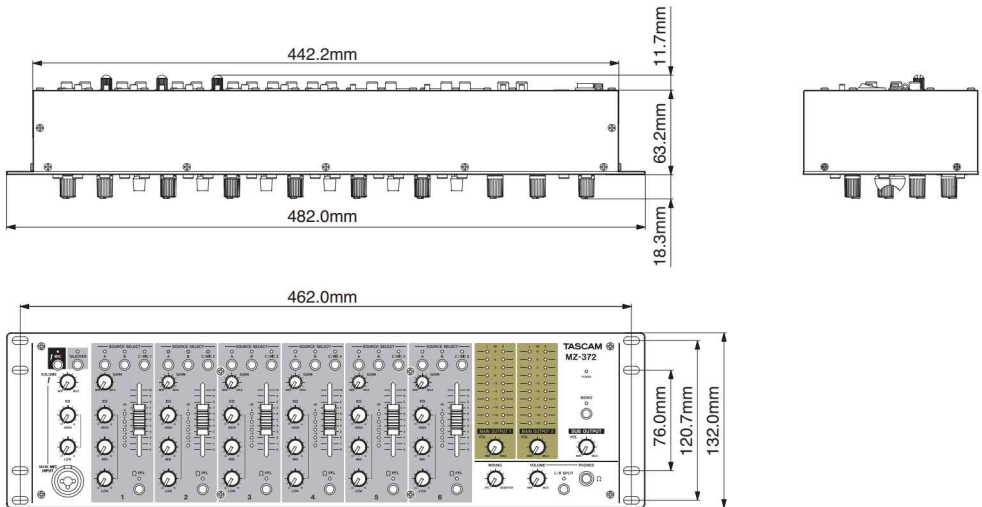

- Illustrations in this manual might differ in part from the actual product.
- Specifications and external appearance might be changed without notification to improve the product.

Block diagram

