

# ティアック株式会社

<http://tascam.jp/>

〒206-8530 東京都多摩市落合1-47

TEAC AMERICA, INC.

<http://tascam.com/>

Phone: +1-323-726-0303

1834 Gage Road, Montebello, California 90640 USA

TEAC MEXICO, S.A. de C.V.

<http://teacmexico.net/>

Phone: +52-55-5010-6000

Río Churubusco 364, Colonia Del Carmen, Delegación Coyoacán, CP 04100, México DF, México

TEAC UK LIMITED

<http://tascam.eu/>

Phone: +44-8451-302511

Meridien House, Ground Floor, 69 - 71, Clarendon Road, Watford, Hertfordshire, WD17 1DS, UK

TEAC EUROPE GmbH

<http://tascam.eu/>

Phone: +49-611-71580

Bahnstrasse 12, 65205 Wiesbaden-Erbenheim, Germany

TEAC SALES & TRADING(SHENZHEN) CO., LTD

<http://tascam.cn/>

Phone: +86-755-88311561~2

Room 817, Block A, Hailrun Complex, 6021 Shennan Blvd., Futian District, Shenzhen 518040, China

Printed in China

# TASCAM

# DR-22WL

## Linear PCM Recorder

D01235000C

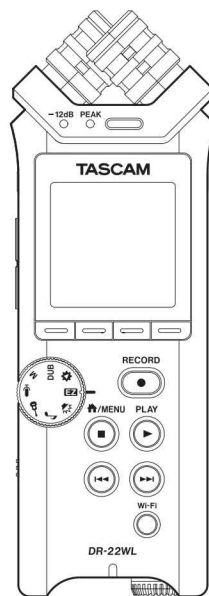

OWNER'S MANUAL

ENGLISH

MODE D'EMPLOI

FRANÇAIS

MANUAL DEL USUARIO

ESPAÑOL

BEDIENUNGSANLEITUNG

DEUTSCH

MANUALE DI ISTRUZIONI

ITALIANO

取扱説明書

日本語



- TASCAM is a trademark of TEAC CORPORATION, registered in the U.S. and other countries.
- microSDXC Logo is a trademark of SD-3C, LLC.



- Supply of this product does not convey a license nor imply any right to distribute MPEG Layer-3 compliant content created with this product in revenue-generating broadcast systems (terrestrial, satellite, cable and/or other distribution channels), streaming applications (via Internet, intranets and/or other networks), other content distribution systems (pay-audio or audio-on-demand applications and the like) or on physical media (compact discs, digital versatile discs, semiconductor chips, hard drives, memory cards and the like). An independent license for such use is required. For details, please visit <http://mp3licensing.com>.
- MPEG Layer-3 audio coding technology licensed from Fraunhofer IIS and Thomson.
- Wi-Fi is a trademark of Wi-Fi Alliance. The Wi-Fi CERTIFIED Logo is a certification mark of Wi-Fi Alliance.
- Microsoft, Windows and Windows Vista are either registered trademarks or trademarks of Microsoft Corporation in the United States and/or other countries.
- Apple, Macintosh, Mac OS and Mac OS X are trademarks of Apple Inc.
- IOS is a trademark or registered trademark of Cisco in the U.S. and other countries and is used under license.
- App Store is a service mark of Apple Inc.
- Google Play and Android are trademarks of Google inc.
- Blackfin® and the Blackfin logo are registered trademarks of Analog Devices, Inc.
- Other company names, product names and logos in this document are the trademarks or registered trademarks of their respective owners.

# Owner's Manual

## IMPORTANT SAFETY INSTRUCTIONS

- 1 Read these instructions.
- 2 Keep these instructions.
- 3 Heed all warnings.
- 4 Follow all instructions.
- 5 Do not use this apparatus near water.
- 6 Clean only with dry cloth.
- 7 Do not block any ventilation openings. Install in accordance with the manufacturer's instructions.
- 8 Do not install near any heat sources such as radiators, heat registers, stoves, or other apparatus (including amplifiers) that produce heat.
- 9 Do not defeat the safety purpose of the polarized or grounding-type plug. A polarized plug has two blades with one wider than the other. A grounding type plug has two blades and a third grounding prong. The wide blade or the third prong are provided for your safety. If the provided plug does not fit into your outlet, consult an electrician for replacement of the obsolete outlet.
- 10 Protect the power cord from being walked on or pinched particularly at plugs, convenience receptacles, and the point where they exit from the apparatus.
- 11 Only use attachments/accessories specified by the manufacturer.
- 12 Use only with the cart, stand, tripod, bracket, or table specified by the manufacturer, or sold with the apparatus. When a cart is used, use caution when moving the cart/apparatus combination to avoid injury from tip-over.
- 13 Unplug this apparatus during lightning storms or when unused for long periods of time.
- 14 Refer all servicing to qualified service personnel. Servicing is required when the apparatus has been damaged in any way, such as power-supply cord or plug is damaged, liquid has been spilled or objects have fallen into the apparatus, the apparatus has been exposed to rain or moisture, does not operate normally, or has been dropped.



- The apparatus draws nominal non-operating power from the AC outlet with its POWER or STANDBY/ON switch not in the ON position.
- The mains plug is used as the disconnect device, the disconnect device shall remain readily operable.
- Caution should be taken when using earphones or headphones with the product because excessive sound pressure (volume) from earphones or headphones can cause hearing loss.
- If you are experiencing problems with this product, contact TEAC for a service referral. Do not use the product until it has been repaired.

### WARNING



To prevent possible hearing damage, do not listen at high volume levels for long periods.

### CAUTION

- Do not expose this apparatus to drips or splashes.
- Do not place any objects filled with liquids, such as vases, on the apparatus.
- Do not install this apparatus in a confined space such as a book case or similar unit.
- The apparatus should be located close enough to the AC outlet so that you can easily grasp the power cord plug at any time.
- If the product uses batteries (including a battery pack or installed batteries), they should not be exposed to sunshine, fire or excessive heat.
- CAUTION for products that use replaceable lithium batteries: there is danger of explosion if a battery is replaced with an incorrect type of battery. Replace only with the same or equivalent type.

### CAUTIONS ABOUT BATTERIES

This product uses batteries. Misuse of batteries could cause a leak, rupture or other trouble. Always abide by the following precautions when using batteries.

- Never recharge non-rechargeable batteries. The batteries could rupture or leak, causing fire or injury.
- When installing batteries, pay attention to the polarity indications (plus/minus (+)/(-) orientation), and install them correctly in the battery compartment as indicated.

Putting them in backward could make the batteries rupture or leak, causing fire, injury or stains around them.

- When you store or dispose batteries, isolate their terminals with insulation tape or something like that to prevent them from contacting other batteries or metallic objects.
- When throwing used batteries away, follow the disposal instructions indicated on the batteries and the local disposal laws.
- Do not use batteries other than those specified. Do not mix and use new and old batteries or different types of batteries together. The batteries could rupture or leak, causing fire, injury or stains around them.
- Do not carry or store batteries together with small metal objects. The batteries could short, causing leak, rupture or other trouble.
- Do not heat or disassemble batteries. Do not put them in fire or water. Batteries could rupture or leak, causing fire, injury or stains around them.
- If the battery fluid leaks, wipe away any fluid on the battery case before inserting new batteries. If the battery fluid gets in an eye, it could cause loss of eyesight. If fluid does enter an eye, wash it out thoroughly with clean water without rubbing the eye and then consult a doctor immediately. If the fluid gets on a person's body or clothing, it could cause skin injuries or burns. If this should happen, wash it off with clean water and then consult a doctor immediately.
- The unit power should be off when you install and replace batteries.
- Remove the batteries if you do not plan to use the unit for a long time. Batteries could rupture or leak, causing fire, injury or stains around them. If the battery fluid leaks, wipe away any fluid on the battery compartment before inserting new batteries.
- Do not disassemble a battery. The acid inside the battery could harm skin or clothing.

### ■ For European Customers

#### Disposal of electrical and electronic equipment

- (a) All electrical and electronic equipment should be disposed of separately from the municipal waste stream via designated collection facilities appointed by the government or the local authorities.

- (b) By disposing of the electrical and electronic equipment correctly, you will help save valuable resources and prevent any potential negative effects on human health and the environment.
- (c) Improper disposal of waste equipment can have serious effects on the environment and human health as a result of the presence of hazardous substances in electrical and electronic equipment.
- (d) The crossed out wheeled dust bin symbol  indicates that electrical and electronic equipment must be collected and disposed of separately from household waste.
- (e) The return and collection systems are available to the end users. For more detailed information about disposal of old electrical and electronic equipment, please contact your city office, waste disposal service or the shop where you purchased the equipment.

## Disposal of batteries and/or accumulators

- (a) Waste batteries and/or accumulators should be disposed of separately from the municipal waste stream via designated collection facilities appointed by the government or the local authorities.
- (b) By disposing of waste batteries and/or accumulators correctly, you will help save valuable resources and prevent any potential negative effects on human health and the environment.
- (c) Improper disposal of waste batteries and/or accumulators can have serious effects on the environment and human health as a result of the presence of hazardous substances in batteries and/or accumulators.
- (d) The crossed out wheeled dust bin symbol  indicates that batteries and/or accumulators must be collected and disposed of separately from household waste.  
If the battery or accumulator contains more than the specified values of lead (Pb), mercury (Hg), and/or cadmium (Cd) defined in the Battery Directive (2006/66/EC), then the chemical symbols for lead (Pb), mercury (Hg) and/or cadmium (Cd) will be indicated beneath the crossed out wheeled dust bin symbol.
- (e) The return and collection systems are available to the end users. For more detailed information about disposal of waste batteries and/or accumulators, please contact your

city office, waste disposal service or the shop where you purchased them.

## Wireless equipment precautions

### Compliance of radio transmitter and interference

#### Model for USA

This device complies with Part.15 of FCC Rules.

Operation is subject to the following two conditions:

- 1) This device may not cause interference, and
- 2) This device must accept any interference, including interference that may cause undesired operation.

Labeling of authorization

FCC ID: YOPGS2100MIP

#### Model for Canada

##### Compliance of radio transmitter

This device complies with Industry Canada licenceexempt RSS standard(s). Operation is subject to the following two conditions: (1) this device may not cause interference, and (2) this device must accept any interference, including interference that may cause undesired operation of the device.

Labeling of authorization

IC ID: 9154A-GS2100MIP

##### Compliance of interference

This ClassB digital apparatus complies with Canadian ICES-003.

#### Model for EEA (European Economic Area)

This equipment complies with the harmonised standards of DIRECTIVE 1999/5/EC (R&TTE).

Labeling of conformity

CE marking: 

#### CAUTION

Changes or modifications not expressly approved by the party responsible for compliance could void the user's authority to operate the equipment.

#### CAUTION

Authorization of wireless devices are different in countries or regions. Please use only in the country where you purchased the product.

- Depending on the country, restrictions on the use of Wi-Fi wireless technology might exist.

Confirm the laws and regulations of the country or region where you want to use the unit before use.

### Radiation Exposure requirements

This equipment meets the regulation, which is recognized internationally, for the case of human exposure to radio waves generated by the transmitter.

#### Based on the following two conditions:

- End-users and installers must be provided with antenna installation instructions and transmitter operating conditions for satisfying RF exposure compliance.
- This equipment should be installed and operated with minimum distance 20 cm (8") between the radiator and your body.

### Statement of compliance

#### Model for USA

This device complies with FCC radiation exposure limits set forth for an uncontrolled environment.

#### Model for Canada

The device meets the exemption from the routine evaluation limits in section 2.5 of RSS 102 and compliance with RSS-102 RF exposure, users can obtain Canadian information on RF exposure and compliance.

#### EEA (European Economic Area) model

This equipment complies with EN.62311; Assessment of electronic and electrical equipment related to human exposure restrictions for electromagnetic fields; the harmonised standard of DIRECTIVE 1999/5/EC.

### Information for interference (FCC requirements)

This equipment has been tested and found to comply with the limits for a Class B digital device, pursuant to Part 15 of the FCC Rules. These limits are designed to provide reasonable



protection against harmful interference in a residential installation.

This equipment generates, uses, and can radiate radio frequency energy and, if not installed and used in accordance with the instructions, may cause harmful interference to radio communications.

However, there is no guarantee that interference will not occur in a particular installation.

If this equipment does cause harmful interference to radio or television reception, which can be determined by turning the equipment off and on, the user is encouraged to try to correct the interference by one or more of the following measures.

- Reorient or relocate the equipment and/or the receiving antenna.
- Increase the separation between the equipment and receiver.
- Connect the equipment into an outlet on a circuit different from that to which the receiver is connected.
- Consult the dealer or an experienced radio/TV technician for help.

### Declaration of Conformity

Model Number : DR-22WL

Trade Name : TASCAM

Responsible party : TEAC AMERICA, INC.

Address : 1834 Gage Road, Montebello, California,  
U.S.A.

Telephone number : 1-323-726-0303

This device complies with Part.15 of FCC Rules.

Operation is subject to the following two conditions:

- 1) This device may not cause interference, and
- 2) This device must accept any interference, including interference that may cause undesired operation.

### DECLARATION OF CONFORMITY

We, TEAC EUROPE GmbH, Bahnstrasse 12,  
65205 Wiesbaden-Erbenheim, Germany  
declare in own responsibility, the TEAC  
product described in this manual is in  
compliance with the corresponding technical standards.



## Contents

|   |    |
|---|----|
| <b>Wireless equipment precautions</b> .....           | 4  |
| Compliance of radio transmitter and interference..... | 4  |
| Radiation Exposure requirements.....                  | 4  |
| Information for interference (FCC requirements).....  | 4  |
| <b>Introduction</b> .....                             | 6  |
| <b>Included items</b> .....                           | 6  |
| <b>Note about the Reference Manual</b> .....          | 6  |
| <b>Precautions for placement and use</b> .....        | 6  |
| <b>Beware of condensation</b> .....                   | 6  |
| <b>Cleaning the unit</b> .....                        | 6  |
| <b>Using the TEAC Global Site</b> .....               | 6  |
| <b>User registration</b> .....                        | 6  |
| <b>Names of Parts</b> .....                           | 7  |
| Top panel.....  | 7  |
| Front panel.....                                      | 7  |
| Left side panel.....                                  | 7  |
| Right side panel.....                                 | 7  |
| Bottom panel.....                                     | 7  |
| <b>Home Screen</b> .....                              | 8  |
| <b>Preparation</b> .....                              | 8  |
| Preparing the power supply.....                       | 8  |
| Starting up the unit.....                             | 8  |
| Setting the built-in clock.....                       | 9  |
| Shutting down.....                                    | 9  |
| Connecting monitoring devices and headphones.....     | 9  |
| <b>Basic menu operation procedures</b> .....          | 9  |
| Menu structure.....                                   | 9  |
| <b>Recording</b> .....                                | 9  |
| Recording Screen.....                                 | 9  |
| Recording.....  | 10 |
| Menu structure.....                                   | 10 |
| <b>Playback</b> .....                                 | 11 |
| Playing back recordings.....                          | 11 |
| Selecting a file for playback (skipping).....         | 11 |
| Adjusting the playback volume.....                    | 11 |
| Using various playback functions.....                 | 11 |
| Menu structure.....                                   | 11 |
| <b>Connecting with a Computer</b> .....               | 11 |
| Connecting the unit to a computer by USB.....         | 11 |
| Exchanging files with a computer.....                 | 11 |
| Disconnecting the unit from a computer.....           | 11 |
| <b>Settings and Information Display</b> .....         | 11 |

|  |    |
|--|----|
| Turning the built-in speaker off.....  | 11 |
| System Settings.....   | 11 |
| <b>Connecting the unit to a smartphone via Wi-Fi</b> .....                       | 12 |
| How to obtain and install the dedicated application (DR CONTROL).....            | 12 |
| Connecting the unit to a smartphone via Wi-Fi for the first time.....            | 12 |
| Connecting the unit to a smartphone via Wi-Fi (second and subsequent times)..... | 13 |
| Remote control of the unit from a smartphone.....                                | 14 |
| File transfer from the unit to a smartphone.....                                 | 14 |
| <b>Quick Reference for Using Various Functions</b> .....                         | 15 |
| <b>Messages</b> .....  | 17 |
| <b>Troubleshooting</b> .....   | 18 |
| <b>Specifications</b> .....  | 19 |
| Ratings.....   | 19 |
| Inputs and outputs.....  | 19 |
| Audio performance.....   | 19 |
| Recording times.....   | 19 |
| Requirements for connected computers.....  | 19 |
| Wi-Fi.....   | 19 |
| General.....   | 19 |

---

## Introduction

---

Thank you very much for purchasing the TASCAM DR-22WL Linear PCM Recorder.

Before connecting and using this unit, please take time to read this manual thoroughly to ensure you understand how to properly set it up and connect it, as well as the operation of its many useful and convenient functions. After you have finished reading this manual, please keep it in a safe place for future reference.

This product has a Blackfin® 16/32-bit embedded processor made by Analog Devices, Inc. This processor controls digital signal processing.  
Inclusion of this Blackfin® processor in the product increases its performance and reduces its power consumption.

---

## Included items

---

This product includes the following items.

Take care when opening the package to avoid damaging the items. Keep the packing materials for transportation in the future.

Please contact the store where you purchased this unit if any of these items are missing or have been damaged during transportation.

- Main unit..... × 1
- microSD card (in the unit)..... × 1
- AA alkaline batteries..... × 2
- USB cable (80 cm)..... × 1
- Owner's Manual (this document) including warranty..... × 1

---

## Note about the Reference Manual

---

This Owner's Manual explains the main functions of this unit. Please see the Reference Manual for information about all the unit's functions.

You can also download this Owner's Manual and the Reference Manual from the TEAC Global Site (<http://teac-global.com/>).

---

## Precautions for placement and use

---

- The environmental temperature operating range of this unit is 0–40°C (32–104°F).
- Do not install this unit in the following types of locations. Doing so could degrade the sound quality and/or cause malfunctions.

Places with significant vibrations

Near windows or other places exposed to direct sunlight

Near heaters or other extremely hot places

Extremely cold places

Places with bad ventilation or high humidity

Very dusty locations

- If this unit is placed near a power amplifier or other device with a large transformer, it could cause a hum. If this occurs, increase the distance between this unit and the other device.
- This unit could cause color irregularities on a TV screen or noise from a radio if used nearby. If this occurs, use this unit farther away.
- This unit might produce noise if a mobile phone or other wireless device is used nearby to make calls or send or receive signals. If this occurs, increase the distance between this unit and those devices or turn them off.
- To enable good heat dissipation, do not place anything on top of this unit.
- Do not place this unit on top of a power amplifier or other device that generates heat.

---

## Beware of condensation

---

If the unit is moved from a cold to a warm place, or used after a sudden temperature change, there is a danger of condensation; vapor in the air could condense on the internal mechanism, making correct operation impossible. To prevent this, or if this occurs, let the unit sit for one or two hours at the new room temperature before using it.

---

## Cleaning the unit

---

Use a dry soft cloth to wipe the unit clean. Do not wipe with chemical cleaning cloths, thinner, alcohol or other chemical

agents. Doing so could damage the surface or cause discoloration.

---

## Using the TEAC Global Site

---

You can download this Owner's Manual and the Reference Manual necessary for this unit from the TEAC Global Site (<http://teac-global.com/>).

1. Open the TEAC Global Site (<http://teac-global.com/>).
2. In the TASCAM Downloads section, click the desired language to open the Downloads website page for that language.

### NOTE

*If the desired language does not appear, click Other Languages.*

3. Click the product name in the "Search by Model Name" section to open the Downloads page for that product.
4. Select and download the Owner's Manual and the Reference Manual that are needed.

---

## User registration

---

Customers in the USA, please visit the TASCAM website (<http://tascam.com/>) to register as a user online.

## Names of Parts

### Top panel

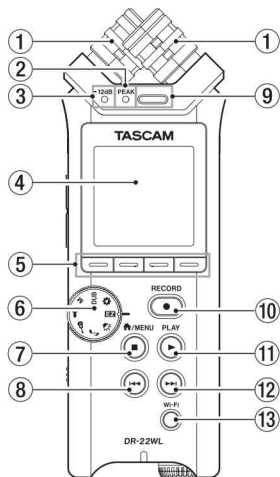

- ① Built-in stereo microphone
- ② PEAK indicator
- ③ -12 dB indicator
- ④ Display
- ⑤ Function buttons
- ⑥ Scene dial
- ⑦ /MENU/ button
- ⑧ Fast rewind button
- ⑨ Built-in mono speaker
- ⑩ RECORD button
- ⑪ PLAY button
- ⑫ Fast forward button
- ⑬ Wi-Fi button

### Front panel

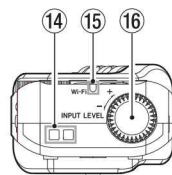

- ⑭ Strap attachment
- ⑮ Wi-Fi indicator
- ⑯ INPUT LEVEL volume control

### Left side panel

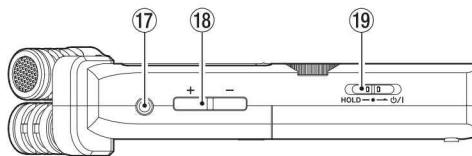

- ⑰ /LINE OUT jack
- ⑱ OUTPUT LEVEL (+/-) button
- ⑲ HOLD/ON/OFF switch

### Right side panel

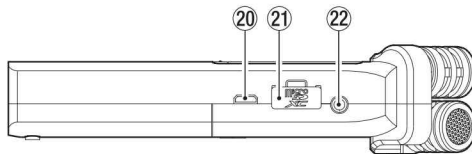

- ⑳ USB port
- ㉑ microSD card slot
- ㉒ MIC/EXT IN jack

### Bottom panel

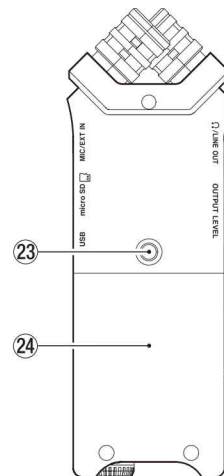

- ㉓ Tripod attachment thread (1/4-inch)
- ㉔ Battery compartment

## Home Screen

This is the screen that is usually shown when the unit is stopped.

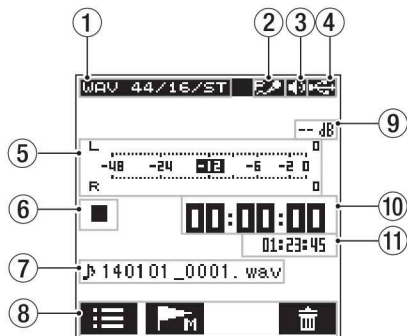

① **Playback file format information**  
Shows format of the file being played back.

② **Plug-in power status**  
Blank: Plug-in power function off  
: Plug-in power function on

③ **Monitoring output**  
: Signal output from the built-in speaker  
: Signal output from headphones

④ **Power supply status**  
When running on battery power, the battery icon shows the amount of power remaining in bars ( ).  
When the icon displays no bar, blinks, and the power subsequently turns off due to dead batteries.  
When using a TASCAM PS-P515U AC adapter (sold separately) or USB bus power, is shown.

⑤ **Level meter**

⑥ **Recorder operation status**  
These icons show the recorder operation status.

| Indicator | Meaning   |
|-----------|---|
| ■         | Stopped   |
|           | Paused  |
| ▶         | Playing back  |
| ▶▶        | Fast-forwarding   |
| ◀◀        | Fast-rewinding  |
| ▶▶▶       | Skipping to the head of the next file                             |
| ◀◀◀       | Skipping to the head of the current file or of the preceding file |

⑦ **File information**

⑧ **Function button information**

⑨ **Peak value in decibels (dB)**

⑩ **Elapsed time**  
Shows the elapsed time (hours : minutes : seconds) of the currently playing track.

⑪ **Remaining time**  
Shows the remaining playback time of the current track (hours : minutes : seconds).

## Preparation

### Preparing the power supply

#### ■ Using AA size batteries

1. Slide open the battery compartment cover on the back of the unit.
2. Install 2 AA batteries with their ⊕ and ⊖ marks as shown in the battery compartment .

3. Close the battery compartment cover.

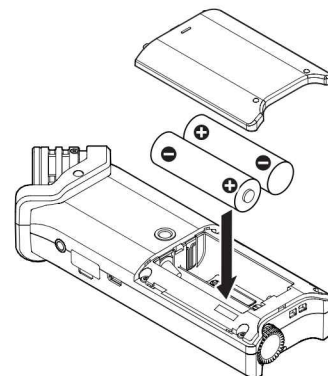

- Use the BATTERY TYPE item of the SETUP page to set the type of battery in order to accurately show the amount of power remaining and allow the unit to accurately determine whether enough power is available for proper operation. (By default, this is set to ALKAL for alkaline batteries.)

### Starting up the unit

Slide the HOLD/⏻ / I switch to the ⏻ / I position until TASCAM DR-22WL (start-up screen) appears.  
The Home Screen appears when the unit starts up.

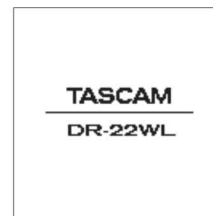



## Setting the built-in clock

When the unit is started up for the first time (or after being left without batteries), the **DATE/TIME** screen appears before the start-up screen to allow the date and time to be set.

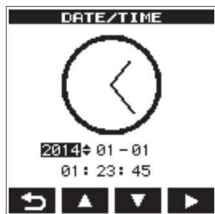

Press the **F4** button to move the cursor (highlighted part), and use the **F2** and **F3** buttons to set the date and time. When finished setting, press the **F1** button to return to the menu screen.

## Shutting down

While the unit is turned on, slide the **HOLD/** switch to the **OFF** position until **TASCAM DR-22WL shutting down** appears on the display.

The power turns off in a few seconds.

## Connecting monitoring devices and headphones

To listen with headphones, connect them to the **LINE OUT** jack.

To listen with an external monitoring system (powered monitor speakers or an amplifier and speakers), connect it to the **LINE OUT** jack.

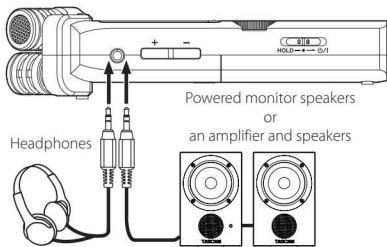

## Basic menu operation procedures

1. Press the **HOME/MENU/** button to open the **REC** page on the menu screen.



2. Press the **F1** button to open menu pages.
3. Use the **F2** or **F3** button to select (highlight) a menu item to set.
4. Press the **F4** button to show the pop-up setting screen.
5. Use the **F2** or **F3** button to change the setting.
6. Press the **F1** button to set a different item in the same menu page.
7. Repeat step 2 to 6 as necessary to set other items.
8. When finished, press the **HOME/MENU/** button to return to the Home Screen.

## Menu structure

### MENU

- REC Basic settings for recording
- TOOL Convenient functions for playback files
- SETUP Basic settings to make the device easy to use
- INFORMATION View information

## Recording

### Recording Screen

The screen below is shown when the unit is in the recording standby state or while recording is in progress.

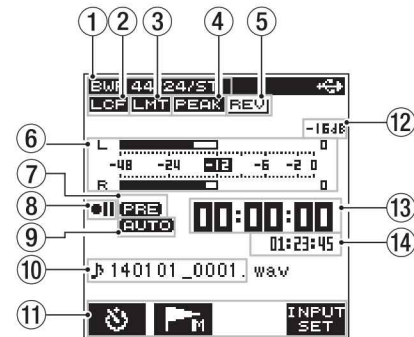

- 1 **Recording mode**  
The recording file format, sampling frequency and stereo/mono (S/T/MONO) status are shown.
- 2 **Low cut filter on/off status**  
Blank: Low pass filter off  
**LFC**: Low pass filter on
- 3 **Limiter on/off status**  
Blank: Limiter off  
**LMT**: Limiter on
- 4 **Peak reduction on/off status**  
Blank: Peak reduction off  
**PEAK**: Peak reduction on
- 5 **Reverb on/off status**

| Icon       | On/off status                              |
|------------|--|
| Blank      | Reverb off                                 |
| <b>REV</b> | Reverb on (Recording with the effector on) |
| <b>REV</b> | Reverb on (SEND status)                    |

## ⑥ Level meter

The level of input sound is shown.

When the auto-recording function is on, the level at which auto-recording starts is shown as a frame.

## ⑦ Pre-recording setting status

Blank: Pre-recording off

**PRE**: Pre-recording on

## ⑧ Recorder operation status

### ⑨ Auto-recording setting status

Blank: Auto-recording off

**AUTO**: Auto-recording on

## ⑩ File name

The file name that will automatically be given to the recorded file is shown.

## ⑪ Function button information

These icons show the recorder operation status.

| Indicator | Meaning                                  |
|-----------|--|
| ● II      | Recording in standby or recording paused |
| ●         | Recording in progress                    |

## ⑫ Peak value in decibels (dB)

The peak recording level value is shown digitally.

**OVER** is shown when recording over the maximum input level (−2 dB or more).

## ⑬ Elapsed recording time

The elapsed recording time of a recorded file is shown as hours : minutes : seconds.

## ⑭ Remaining recording time

The remaining recording time for the microSD card is shown as hours : minutes : seconds.

## Recording

By selecting with the scene dial, you can record easily with an optimized setting for the scene you want to record.

| Purpose                               | Mark      | Name       |
|---------------------------------------|-----------|------------|
| Record easily right away              | <b>EZ</b> | EASY       |
| Record loud sounds                    |           | LOUD       |
| Record a concert or chorus            |           | MUSIC      |
| Record an instrument such as a guitar |           | INSTRUMENT |
| Record an interview                   |           | INTERVIEW  |

### ■ Recording easily right away

1. Set the **scene dial** to **EZ**.
2. Press the **RECORD** button to start recording immediately.

### NOTE

*The input level is adjusted automatically (you cannot change manually).*

3. Press the **HOME/MENU/STOP** button to finish recording.

### ■ Recording using selected scene settings

1. Set the **scene dial** to the scene (///) you want to record.
2. Press the **RECORD** button to enter recording standby.
3. Use the **INPUT LEVEL** volume control to adjust the input level.  
To obtain higher quality, it is recommended that you record as loud a sound as possible. Raise the input level so that the **−12 dB** indicator lights green in order to optimize the recording level. If the input level is set too high, the sound may be distorted. To avoid this, lower the input level when the **PEAK** indicator lights red.
4. Press the **RECORD** button again to start recording.
5. Press the **HOME/MENU/STOP** button to finish recording.

### ■ Recording using the manual mode

1. Set the **scene dial** to **M**.
2. Press the **RECORD** button to enter recording standby.
3. Use the **INPUT LEVEL** volume control to adjust the input level.  
To obtain higher quality, it is recommended that you record as loud a sound possible. Raise the input level

so that the **−12 dB** indicator lights green in order to optimize the recording level. If the input level is set too high, the sound may be distorted. To avoid this, lower the input level when the **PEAK** indicator lights red.

4. Press the **RECORD** button again to start recording.  
When recording starts, the **REC** indicator lights continuously and the display shows the elapsed recording time and the remaining recording time.
5. Press the **HOME/MENU/STOP** button to finish recording.

### ■ Pausing recording

You can pause recording and then continue recording in the same file.

1. While recording, press the **RECORD** button to pause.
2. Press the **RECORD** button again to resume recording.

## Menu structure

|               |  |
|---------------|--|
| REC           |  |
| — FORMAT      | Set the file format<br>WAV: 16/24 bit,<br>MP3: 32 k–320 kbps   |
| — SAMPLE      | Set the sampling frequency<br>44.1/48/96 kHz (96 kHz for WAV only)   |
| — TYPE        | Set to mono or stereo<br>MONO, STEREO  |
| — PRE REC     | Set the pre-recording function<br>ON, OFF  |
| — AUTO FUNC   | Set the track incrementation, auto-recording, and mark function<br>TRACK INCREMENT, AUTO REC, PEAK MARK, AUTO MARK |
| — DUAL FORMAT | Set dual format recording<br>OFF,<br>MP3: 32 k–320 kbps  |
| — COUNT INIT  | Reset the number used as the file name   |
| — PEAK HOLD   | Set the peak hold function<br>OFF, ON  |

---

## Playback

---

### Playing back recordings

While the Home Screen is open and playback is stopped, press the **PLAY** button to start playback.

#### ■ Pausing

While the Home Screen is open and a track is playing back, press the **PLAY** or **HOME/MENU/STOP** button to pause playback at the current position. (PAUSE)

#### ■ Fast-rewinding and fast-forwarding (search)

While the Home Screen is open, press and hold the **REWIND** or **FAST-FORWARD** button to search backward or forward.

---

### Selecting a file for playback (skipping)

During playback or while stopped, use the **REWIND** and **FAST-FORWARD** buttons to select the file that you want to play.

If you press the **REWIND** button when the playback position is at the middle of a file, playback will skip to the beginning of that file. If you press the **FAST-FORWARD** button when at the beginning of a file, playback will skip to the next file.

---

### Adjusting the playback volume

The volume of sound output through the **Ω/LINE OUT** jack can be adjusted using the **OUTPUT LEVEL (+/-)** button while the Home Screen is open.

---

### Using various playback functions

1. While playing back, stopped, or paused, set the **scene dial** to **▶**.
2. Use the **F3 [SEL]** button to select an item, and then press the **F4 [ENTER]** button to enable selection of various values. Please see the Reference Manual for information about playback functions.

---

## Menu structure

### TOOL

|                                  |   |
|----------------------------------|---|
| MARK SKIP MODE                   | Set the mark skip mode<br>OFF/ON                                |
| DIVIDE                           | Divide a file   |
| METRONOME<br>(Ver1.10-supported) | Use the metronome function<br><br>OFF/ON, TEMPO, BEAT<br>LEVEL, |
| REVERB                           | Set reverb<br>SW, TYPE, LEVEL, MODE                             |
| SPEAKER                          | Set the built-in speaker<br>OFF, ON                             |

---

## Connecting with a Computer

You can transfer audio files on the microSD card in the unit to a computer and also transfer audio files from a computer to the unit.

---

### Connecting the unit to a computer by USB

1. Use the included USB cable to connect the unit to a computer. If the power is off, turn it on.
2. On the **USB SELECT** screen, select **STORAGE** and press the **F4 [ENTER]** button to connect this unit to the computer. **USB connected** will appear on the display.
3. When you open "Computer" in Windows, this unit shows on the computer screen as an external volume named "DR-22WL".

---

## Exchanging files with a computer

Click the "DR-22WL" drive on the computer screen to show the "MUSIC" and "UTILITY" folders.

To transfer files to the computer, open the "MUSIC" folder and drag and drop the desired files where you want them to go.

To transfer files from the computer, drag and drop the desired audio files on the computer to the "MUSIC" folder.

---

## Disconnecting the unit from a computer

Before disconnecting the USB cable, follow the proper procedures for the computer to unmount this unit.

The power turns off after the unit completes its shutdown process.

See the computer's operation manual for instructions about how to unmount an external device.

---

## Settings and Information Display

---

### Turning the built-in speaker off

Select the **HOME/MENU/STOP** button → **TOOL** → **SPEAKER** and set the speaker to **OFF**.

---

### System Settings

Use the **SETUP** menu to customize settings for using the unit. You can also perform operations such as initializing settings and formatting microSD cards.

1. Select the **HOME/MENU/STOP** button → **SETUP** → a system setting item, and then press the **F4 [ENTER]** button.
2. Configure necessary settings for each function.

## Connecting the unit to a smartphone via Wi-Fi

### CAUTION

*This product has been designed to be compliant with rules and regulations in the sales area, display as needed has been. This product is used in the country / region of the following has been approved.*

*United States, Canada, Europe (EU Member States), Australia, New Zealand, Japan*

*In countries other than the above, you might have to use the WiFi function is limited. Before using, please check the laws and regulations of the country.*

You can operate this unit by remote control with a free dedicated application (DR CONTROL). In addition to transport control operations such as playback and stop, you can also adjust the input, transfer recorded files and more via Wi-Fi.

## How to obtain and install the dedicated application (DR CONTROL)

1. Connect your smartphone to the Internet.
2. If your smartphone is an Android device, download and install the dedicated application (DR CONTROL) from Google Play. If it is an iOS device, download and install from the App Store.

## Connecting the unit to a smartphone via Wi-Fi for the first time

You can connect the unit to a smartphone directly via Wi-Fi. Therefore, you do not need external devices, such as a router, or a Wi-Fi network environment. For the connection, you only need the unit and your smartphone.

When connecting the unit to your smartphone by Wi-Fi, you cannot connect the smartphone to an external Wi-Fi network.

### ■ If using an iOS device

1. Press the **Wi-Fi** button of the unit to make the **Wi-Fi** indicator blink.  
A pop-up message appears on the display.

2. You will be making a connection to a new smartphone, so press the **F3** **[YES]** button.

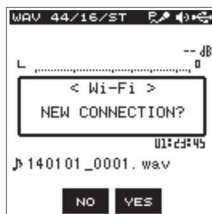

3. "SSID" and "Encryption key" appear on the display, and then the unit enters the WPS mode automatically.

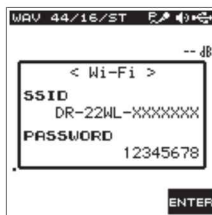

### NOTE

*The WPS mode is the standard for easy connection between Wi-Fi devices. The unit employs push buttons for Android devices.*

4. On your iOS device, select "Settings" → "Wi-Fi".

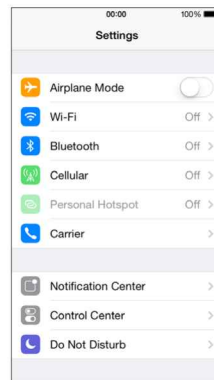

5. When you turn on Wi-Fi on your iOS devices, a Wi-Fi device SSID list appears. Select the SSID shown on the display of the unit.

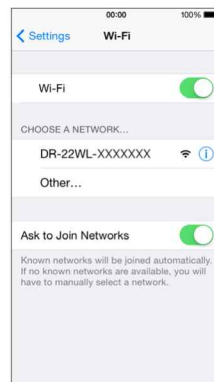

6. A password input screen appears on the iOS device. Enter the encryption key shown on the display of the unit.
7. A Wi-Fi connection between the unit and your smartphone is established and the **Wi-Fi** indicator is lit.



## ■ If using an Android device

1. Press the **Wi-Fi** button of the unit to make the **Wi-Fi** indicator blink.  
A pop-up message appears on the display.
2. You will be making a connection to a new smartphone, so press the **F3** **YES** button.



3. "SSID" and "Encryption key" appear on the display, and then the unit enters the WPS mode automatically.



### NOTE

*The WPS mode is the standard for easy connection between Wi-Fi devices. This unit employs the PIN code system for iOS devices.*

4. On your Android device, select "Settings" → "Wi-Fi".



5. When you turn on Wi-Fi on your Android devices, a Wi-Fi device SSID list appears. Select the SSID shown on the display of the unit.



6. A password input screen appears on the Android device. Enter the encryption key shown on the display of the unit.
7. A Wi-Fi connection between the unit and your smartphone is established and the **Wi-Fi** indicator is lit.

### NOTE

*The operation for Android devices explained above is for smartphones. For details, see your smartphone's operation manual.*

## Connecting the unit to a smartphone via Wi-Fi (second and subsequent times)

Once you have connected the unit to your smartphone, you can connect them again in the future simply by selecting SSID.

## ■ If using an iOS device

1. Press the **Wi-Fi** button of the unit to make the **Wi-Fi** indicator blink.  
A pop-up message appears on the display.
2. You will be making a connection to a previously connected smartphone, so press the **F2** **NO** button.



3. The pop-up message on the display disappears and the unit waits for a connection with a smartphone.
4. On your iOS device, select "Settings" → "Wi-Fi".
5. When you turn on Wi-Fi on your iOS device, a Wi-Fi device SSID list appears. Select the SSID shown on the display of the unit.
6. A Wi-Fi connection between the unit and your smartphone is established and the **Wi-Fi** indicator is lit.

## ■ If using an Android device

1. Press the **Wi-Fi** button of the unit to make the **Wi-Fi** indicator blink.  
A pop-up message appears on the display.
2. You will be making a connection to a previously connected smartphone, so press the **F2** NO button.



3. The pop-up message on the display disappears and the unit waits for a connection with a smartphone.
4. On your Android device, select "Settings" → "Wi-Fi".
5. When you turn on Wi-Fi on your Android device, a Wi-Fi device SSID list appears. Select the SSID shown on the display of the unit.
6. A Wi-Fi connection between the unit and your smartphone is established and the **Wi-Fi** indicator is lit.

### NOTE

*The operation for Android devices explained above is for smartphones. For details, see your smartphone's operation manual.*

## Remote control of the unit from a smartphone

Since the dedicated application (DR CONTROL) has the same display screen as that of the unit, you can operate the unit by remote control with the application almost the same way as operating from the unit. Before using the "DR CONTROL" application, confirm how to operate the unit. That way, you will be able to use the application smoothly.

1. When you have established the Wi-Fi connection between the unit and your smartphone, start the "DR CONTROL" application installed on your smartphone.
2. After starting the "DR CONTROL" application, the following screen appears on your smartphone and you are able to operate the unit by remote control.



For a detailed explanation of the "DR CONTROL" application, see the "DR CONTROL Reference Manual", which can be downloaded from the TEAC Global Site (<http://teac-global.com/>).

## File transfer from the unit to a smartphone

1. Press the "Browse" button on the "DR CONTROL" screen.
2. The file list of the unit appears on the "Browse" screen. Select a file to transfer.
3. A file details screen appears. Press the "Copy" button.
4. A file copy confirmation screen appears. When you press the "YES" button, file transfer from the unit to the smartphone starts.

## Quick Reference for Using Various Functions

- Button names are shown like this: **HOME/MENU/STOP**.
- Instructions are abbreviated. For example, 'On the Home Screen, press the **HOME/MENU/STOP** button, select the **REC** menu, and then select the **PRE REC** item' becomes: 'Home Screen → **HOME/MENU/STOP** → **REC** → **PRE REC**'.
- Not all operation steps are given for complex operations. For detailed operation procedures, see the Reference Manual.

| Category                 | Desired action                                       | Function name               | Procedure, buttons used and explanation   |
|--------------------------|--|-----------------------------|---|
| Basic functions          | Return to the Home Screen                            |                             | <b>HOME/MENU/STOP</b><br>Return to the Home Screen if you become unsure about how to proceed.   |
|                          | Record   |                             | Home Screen → <b>RECORD</b> → <b>RECORD</b><br>Recording will start with the current settings used.   |
|                          | Play back a file                                     |                             | Home Screen → <b>PLAY</b><br>Plays the file shown (selected).   |
|                          | Adjust the playback volume                           |                             | Home Screen → <b>OUTPUT LEVEL (+/-)</b><br>Adjusts the volume of headphones, speakers, etc.   |
|                          | Select a file to play back                           |                             | Home Screen → <b>◀◀/▶▶</b><br>The browse function is convenient for when there are many files.  |
| Recording                | Change the file format                               |                             | Home Screen → <b>HOME/MENU/STOP</b> → <b>REC</b> → <b>FORMAT</b><br>Sets the file format used for recordings, including whether they are uncompressed (WAV) or compressed (MP3).                                |
|                          | Set the low-cut filter                               | Low-cut filter function     | Home Screen → <b>RECORD</b> → <b>F4</b> → <b>INPUT</b> → <b>LCF</b><br>This function removes noise and other sounds at low frequencies. Select the cutoff frequency.  |
|                          | Adjust the input level manually                      |                             | Home Screen → <b>RECORD</b> → <b>INPUT LEVEL</b><br>Watch the meters and set the recording level so that they do not peak.  |
|                          | Adjust the input level automatically                 | Peak reduction              | Home Screen → <b>RECORD</b> → <b>F4</b> → <b>INPUT</b> → <b>PEAK</b><br>This function automatically lowers the level when recording over the maximum input level.   |
|                          | Adjust the input level automatically                 | Limiter                     | Home Screen → <b>RECORD</b> → <b>F4</b> → <b>INPUT</b> → <b>LIMITER</b><br>This function compresses only loud sounds to prevent recording over the maximum input level and does not change the recording level. |
| Other recording features | Add a mark while recording                           | Marking function            | Recording Screen → <b>F2</b><br>This function adds a mark to the file that can be used as an index during playback.   |
|                          | Switch files manually while recording                | Manual track incrementation | Recording Screen → <b>F1</b><br>Use this function when you want to change a file to another and continue recording such as at the interval between songs.   |
|                          | Start recording from slightly before pressing RECORD | PRE REC function            | Home Screen → <b>HOME/MENU/STOP</b> → <b>REC</b> → <b>PRE REC</b><br>When the unit is slow to change from recording standby to recording state, this function allows the unit to compensate the delay.          |
|                          | Use the self-timer to record                         | Self-timer                  | Home Screen → <b>RECORD</b> → <b>F1</b><br>This self-timer function is convenient when you want to record your own performance.   |
|                          | Repeat playback between two points in a file         | Loop playback               | <b>Scene dial</b> → <b>▶</b> → <b>F3</b> → <b>I/O LOOP</b><br>This function allows you to repeat playback of a specific interval in a single file.  |

| Category                | Desired action                                 | Function name                   | Procedure, buttons used and explanation   |
|-------------------------|--|---------------------------------|---|
| Other playback features | Change playback speed                          | VSA                             | <b>Scene dial</b> → ► → <b>F3</b> → <b>SPEED</b><br>This function allows you to change the speed of playback.   |
|                         | Change keys during playback                    | Key change                      | <b>Scene dial</b> → ► → <b>F3</b> → <b>KEY</b><br>This function allows you to change the key during playback.   |
| File operations         | Check file information                         |                                 | Home Screen → <b>HOME/MENU/■</b> → <b>INFO</b><br>Use this function to check the date of recording, file size, etc.   |
|                         | Delete a file                                  |                                 | Home Screen → <b>F1</b> → <b>F2/F3</b> → <b>F4</b> → <b>DELETE</b><br>You can delete files that you do not need.  |
|                         | Delete a file                                  |                                 | Home Screen → <b>F4</b><br>You can delete files that you do not need.   |
|                         | Delete all files in a folder at the same time  |                                 | Home Screen → <b>F1</b> → <b>F2/F3</b> → <b>F4</b> → <b>PROJECT DELETE</b><br>You can delete all the files in a folder at the same time.  |
|                         | Divide a file                                  | Dividing function               | Home Screen → <b>HOME/MENU/■</b> → <b>TOOL</b> → <b>DIVIDE</b><br>Use this function to divide one file into two files.  |
| Unit settings           | Set the date and time                          |                                 | Home Screen → <b>HOME/MENU/■</b> → <b>SETUP</b> → <b>DATE/TIME</b><br>Use this function to set the internal clock, which is used for purposes such as adding the recording date written to files. |
|                         | Turn the speaker off                           |                                 | Home Screen → <b>HOME/MENU/■</b> → <b>TOOL</b> → <b>SPEAKER</b> → <b>OFF</b><br>Stops sound output from the speaker in the back of the unit.  |
|                         | Check information about the unit and the card. |                                 | Home Screen → <b>HOME/MENU/■</b> → <b>INFO</b> → <b>CARD INFO</b><br>Checks information such as the unit firmware version and the amount of remaining space on the card.                          |
|                         | Change the power saving function setting       | Automatic power saving function | Home Screen → <b>HOME/MENU/■</b> → <b>SETUP</b> → <b>AUTO PWR SAVE</b><br>This function automatically turns the unit off when it is not in use.   |
|                         | Change the backlight setting                   |                                 | Home Screen → <b>HOME/MENU/■</b> → <b>SETUP</b> → <b>BACKLIGHT</b><br>Changes the display backlight setting.  |
|                         | Adjust the display contrast                    |                                 | Home Screen → <b>HOME/MENU/■</b> → <b>SETUP</b> → <b>CONTRAST</b><br>Sets the gradation of shading shown on the display.  |
|                         | Set the battery type                           |                                 | Home Screen → <b>HOME/MENU/■</b> → <b>SETUP</b> → <b>BATTERY TYPE</b><br>Selects the type of battery being used. This setting affects the accuracy of the remaining battery power display.        |
|                         | Restore the unit to its default settings       | Initializing function           | Home Screen → <b>HOME/MENU/■</b> → <b>SETUP</b> → <b>INITIALIZE</b><br>Restores all settings to their factory defaults.   |
|                         | Format the microSD card                        | Formatting function             | Home Screen → <b>HOME/MENU/■</b> → <b>SETUP</b> → <b>MEDIA FORMAT</b><br>Formats the card.  |
|                         | Set the file name format                       |                                 | Home Screen → <b>HOME/MENU/■</b> → <b>SETUP</b> → <b>FILE NAME</b><br>You can change the characters used in the automatically assigned file names.  |



## Messages

The following is a list of pop-up messages.

Refer to this list if one of these pop-up messages appears and you want to check the meaning or determine the method of dealing with the problem.

| Message                          | Meaning and method of dealing with a problem  |
|----------------------------------|---|
| File Name ERR                    | DIVIDE caused the number of characters of a file name to exceed 200. The DIVIDE function adds "_a" or "_b" to the end of the file name. Before using the DIVIDE function, connect the unit to a computer and edit the file name to less than 198 characters.  |
| Dup File Name                    | A file with the same name as that of a file created by DIVIDE exists in the same folder. The DIVIDE function adds "_a" or "_b" to the end of the file name. Before using the DIVIDE function, connect the unit to a computer and edit the file name.  |
| File Not Found                   | The file may be damaged. Check the relevant file.   |
| Non-Supported                    | The file format is not supported. See "Connecting the Unit to a Computer" in the Reference Manual for file formats that this unit can use.  |
| Battery Empty                    | The batteries are almost out of power. Replace the batteries.   |
| I/O Too Short                    | The IN and OUT points are too close together. Set them with at least 1 second between them.   |
| MBR Error Init CARD              | The card may not formatted properly or it may be broken. Change the card or press the <b>F4</b> button while this message is being shown to format the card.<br>Formatting will erase all the data on the card.   |
| Format Error<br>Format CARD      | The card may not formatted properly or it may be broken. This message also appears if the card was formatted by use of a computer connected via USB or if an unformatted card is inserted in the unit.<br>Always use the DR-22WL to format cards to be used with it. Change the card or press the <b>F4</b> button while this message is being shown to format the card.<br>Formatting will erase all the data on the card. |
| File Not Found<br>Make Sys File  | The system file is missing. This unit requires a system file to operate. While this message is shown, press the <b>F4</b> button to create a system file.   |
| Invalid SysFile<br>Make Sys File | The system file required to operate this unit is invalid. While this message is shown, press the <b>F4</b> button to create a new system file.  |
| Invalid Card<br>Change Card      | Something might be wrong with the card. Change the card.  |
| Write Timeout                    | Writing to the card timed out.<br>Back up files on the card to a computer and format the card.  |
| Card Full                        | The card has no remaining capacity. Delete unnecessary files or move them to a computer to make open space.   |

| Message        | Meaning and method of dealing with a problem   |
|----------------|--|
| Can't Divide   | The selected division point used when DIVIDE was performed is not appropriate. (It is too close to the beginning or end of the track.) |
| Max File Size  | The file is larger than the designated size or the recording time exceeded 24 hours.   |
| File Full      | The total number of folders and files exceeded 5000. Delete unnecessary folders and files or move them to a computer.                  |
| Card Error     | The card could not be recognized properly. Change the card.  |
| File Protected | The file is read only and cannot be deleted.   |
| No Card        | No card is in the unit, so recording is not possible.  |
| No PB File     | There is no file that can be played back. The file may be damaged.   |
| No MUSIC File  | There is no playback file, so DIVIDE cannot be executed.   |

If any other error occurs, turn the unit off and restart it.

---

## Troubleshooting

---

If the unit does not operate properly, conduct the following inspections before requesting repair. If these measures do not solve the problem, please contact the store where you bought the unit or TEAC customer support.

### ■ The unit does not turn on.

- Confirm that the batteries are not dead.
- Confirm that the batteries are installed in the correct ⊕/⊖ orientation.
- Confirm that the AC adapter (TASCAM PS-P515U, sold separately) is securely connected to both the outlet and USB connector of the unit.
- When using USB bus power, confirm that the USB cable is securely connected.
- When using USB bus power, confirm that the USB cable is not connected via a USB hub.
- Confirm that the **HOLD/⏻/⏻** switch is not set to **HOLD**.

### ■ The unit turns off automatically.

- Confirm that the automatic power saving function is not turned on. See "Setting the automatic power saving function" in "Settings and Information" of the Reference Manual.
  - Since this unit complies with the European Standby Power Regulations (ErP), the automatic power saving function operates regardless of whether the unit is being powered by an AC adapter or batteries. If you do not want to use the automatic power saving function, set it to "OFF". (The factory default setting is "30 min".)

### ■ The unit does not function.

- Confirm that the **HOLD/⏻/⏻** switch is not set to **HOLD**.
- Confirm that the unit is not connected to a computer by a USB cable. (**USB connected** is shown on the display.)

### ■ The unit will not play back.

- Confirm that the microSD card is inserted completely.

### ■ Playback is not possible.

- If you are trying to play back a WAV file, confirm that the sampling frequency is supported by this unit.

- If you are trying to play an MP3 file, confirm that the bit rate is supported by this unit.

### ■ No sound is output from the speaker.

- Confirm that the headphones are not connected.
- Confirm that **SPEAKER** is not set to **OFF**.
- Check the connection to the monitoring system.
- Confirm that the volume of the monitoring system is not minimized.
- Confirm that the **OUTPUT LEVEL** setting of the unit is not minimized.

### ■ The unit will not record.

- If you are using an external device, check the connection again.
- Check the input settings again.
- Confirm that the recording level is not too low.
- Confirm that the microSD card is not full.
- Confirm that the number of files has not reached the maximum that the unit can handle.

### ■ The recording level is low.

- Confirm that the input level setting is not too low.
- Confirm that the output level of any connected device is not too low.

### ■ Sound recorded is distorted.

- Confirm that the input level setting is not too high.
- Confirm that reverb is not enabled.

### ■ The playback sounds unnatural.

- Confirm that the playback speed has not been changed.
- Confirm that the level control function is not enabled.
- Confirm that reverb is not in enabled.

### ■ Files cannot be deleted.

- Confirm that you are not trying to delete a file that has been copied from a computer after being write-protected.

### ■ This unit's files do not appear on the computer.

- Confirm that the unit is connected to the computer via its USB port.
- Confirm that a USB hub is not being used.

- Confirm that the unit is not recording or in the recording standby state.

### ■ The unit cannot be connected to a smartphone or communications between them stops.

- Confirm that the Wi-Fi device is turned on and Wi-Fi is on.
- Confirm that the distance between the Wi-Fi device and the unit is not too large.

Also confirm that there are no walls or obstacles between them.

When a Wi-Fi device is to the rear side of this unit, the unit itself may interrupt communications.

Change the positions of the Wi-Fi device and the unit.

- Turn the unit off, and then turn it on again.
- Delete the registration of "DR-22WL" of the Wi-Fi device and follow the steps in "Connecting the unit to a smartphone via Wi-Fi".

---

## Specifications

---

### Ratings

#### ■ Recording media

microSD card (64 MB–2 GB)  
microSDHC card (4 GB–32 GB)  
microSDXC card (64 GB–128 GB)

#### ■ Recording/playback formats

WAV: 44.1/48/96 kHz, 16/24 bit  
MP3: 44.1/48 kHz, 32/64/96/128/192/256/320 kbps

#### ■ Number of channels

2 channels (stereo)

---

### Inputs and outputs

#### ■ MIC/EXT IN jack (can provide plug-in power)

Connector: 1/8" (3.5 mm) stereo mini jack

#### ■ /LINE OUT jack

Connector: 1/8" (3.5 mm) stereo mini jack

#### ■ Built-in speaker

0.3 W (mono)

#### ■ MicroUSB port

Connector: Micro-B type  
Format: USB 2.0 HIGH SPEED mass storage class

---

### Audio performance

#### ■ Frequency response

20-20 kHz +1/-3 dB  
(EXT IN to LINE OUT, 44.1 kHz sampling frequency, JEITA)  
20-22 kHz +1/-3 dB  
(EXT IN to LINE OUT, 48 kHz sampling frequency, JEITA)  
20-40 kHz +1/-3 dB  
(EXT IN to LINE OUT, 96 kHz sampling frequency, JEITA)

#### ■ Distortion

0.05% or less  
(EXT IN to LINE OUT, 44.1/48/96 kHz sampling frequency, JEITA)

#### ■ S/N ratio

92 dB or higher  
(EXT IN to LINE OUT, 44.1/48/96 kHz sampling frequency, JEITA)

Note: JEITA indicates compliance with JEITA CP-2150

---

### Recording times

| File format<br>(setting when recording) |                     | Capacity<br>4 GB    |
|---|---------------------|---------------------|
| WAV 16 bit (STEREO)                     | 44.1 kHz            | 6 hours 44 minutes  |
| WAV 24 bit (STEREO)                     | 96 kHz              | 2 hours 04 minutes  |
| MP3 (STEREO/MONO)<br>320 kbps           | 44.1 kHz/<br>48 kHz | 29 hours 48 minutes |

- The recording times shown above are estimates. Times may differ depending on the microSD/microSDHC/microSDXC card in use.
  - The recording times shown above are not continuous recording times, but rather they are the total possible recording times for the microSD/microSDHC/microSDXC card.
- 

### Requirements for connected computers

Check the TEAC Global Site (<http://teac-global.com/>) for the latest information about supported operating systems.

#### ■ Supported operating systems

Windows: Windows XP, Windows Vista, Windows 7, Windows 8 (including 8.1)

Macintosh: Mac OS X 10.2 or later

---

### Wi-Fi

#### ■ Wireless standard

Compliant with IEEE 802.11b/g/n (2.4 GHz only)

#### ■ Wireless communication mode

Simple access point (Limited AP)

#### ■ Security

WPA2-PSK (WPS2.0-supported)

---

### General

#### ■ Power supply

2 AA batteries (alkaline or NiMH)  
USB bus power from a computer  
AC adapter (TASCAM PS-P515U, sold separately)

#### ■ Power consumption

1.7 W (maximum)

---

## ■ Battery operation time (continuous operation)

### Using alkaline batteries (EVOLTA)

|           | Format                | Operation time   | Note                        |
|-----------|-----------------------|------------------|-----------------------------|
| Recording | WAV, 44.1 kHz, 16 bit | About 17.5 hours | Recording with built-in mic |
| Playback  | WAV, 44.1 kHz, 16 bit | About 19 hours   | Using built-in speaker      |

Recording: JEITA recording time      Playback: JEITA music playback time

### Using NiMH batteries (eneloop)

|           | Format                | Operation time   | Note                        |
|-----------|-----------------------|------------------|-----------------------------|
| Recording | WAV, 44.1 kHz, 16 bit | About 13.5 hours | Recording with built-in mic |
| Playback  | WAV, 44.1 kHz, 16 bit | About 14.5 hours | Using built-in speaker      |

Recording: JEITA recording time      Playback: JEITA music playback time

## ■ Dimensions

52.2 × 155 × 36.6 mm (W x H x D)

## ■ Weight

170 g/123 g (including batteries/not including batteries)

## ■ Operating temperature range

0 °C–40 °C

- Illustrations in this manual may differ in part from the actual product.
- Specifications and external appearance may be changed without notice to improve the product.
- Detailed specifications are provided in the Reference Manual.