

TASCAM

D01236200B

DR-10X

Compact Linear PCM Recorder



OWNER'S MANUAL

ENGLISH

MODE D'EMPLOI

FRANÇAIS

MANUAL DEL USUARIO

ESPAÑOL

BEDIENUNGSANLEITUNG

DEUTSCH

MANUALE DI ISTRUZIONI

ITALIANO

取扱説明書

日本語

- TASCAM is a trademark of TEAC CORPORATION, registered in the U.S. and other countries.
- microSDHC Logo is a trademark of SD-3C, LLC.



- Other company names, product names and logos in this document are the trademarks or registered trademarks of their respective owners.

ティアック株式会社

<http://tascam.jp/>

〒206-8530 東京都多摩市落合1-47

TEAC AMERICA, INC.

<http://tascam.com/>

Phone: +1-323-726-0303

1834 Gage Road, Montebello, California 90640 USA

TEAC MEXICO, S.A. de C.V.

<http://teacmexico.net/>

Phone: +52-55-5010-6000

Río Churubusco 364, Colonia Del Carmen, Delegación Coyoacán, CP 04100, México DF, México

TEAC UK Ltd.

<http://tascam.eu/>

Phone: +44-8451-302511

2 Huxley Road, Surrey Research Park, Guildford, GU2 7RE, United Kingdom

TEAC EUROPE GmbH

<http://tascam.eu/>

Phone: +49-611-71580

Bahnstrasse 12, 65205 Wiesbaden-Erbenheim, Germany

TEAC SALES & TRADING(SHENZHEN) CO., LTD

Phone: +86-755-88311561~2

Room 817, Block A, Hailrun Complex, 6021 Shennan Blvd., Futian District, Shenzhen 518040, China

Owner's Manual

IMPORTANT SAFETY PRECAUTIONS

For U.S.A.

INFORMATION TO THE USER

This equipment has been tested and found to comply with the limits for a Class B digital device, pursuant to Part 15 of the FCC Rules. These limits are designed to provide reasonable protection against harmful interference in a residential installation. This equipment generates, uses, and can radiate radio frequency energy and, if not installed and used in accordance with the instruction manual, may cause harmful interference to radio communications. However, there is no guarantee that interference will not occur in a particular installation. If this equipment does cause harmful interference to radio or television reception, which can be determined by turning the equipment off and on, the user is encouraged to try to correct the interference by one or more of the following measures.

- a) Reorient or relocate the receiving antenna.
- b) Increase the separation between the equipment and receiver.
- c) Connect the equipment into an outlet on a circuit different from that to which the receiver is connected.
- d) Consult the dealer or an experienced radio/TV technician for help.

CAUTION

Changes or modifications to this equipment not expressly approved by TEAC CORPORATION for compliance could void the user's authority to operate this equipment.

For Canada

THIS CLASS B DIGITAL APPARATUS COMPLIES WITH CANADIAN ICES-003.
CET APPAREIL NUMERIQUE DE LA CLASSE B EST CONFORME A LA NORME
NMB-003 DU CANADA.

Declaration of Conformity

Responsible party : TEAC AMERICA, INC.
Address : 1834 Gage Road, Montebello, California,
U.S.A.

Telephone number : 1-323-726-0303

This device complies with Part 15 of the FCC Rules. Operation is subject to the following two conditions: (1) this device may not cause harmful interference, and (2) this device must accept any interference received, including interference that may cause undesired operation.



DECLARATION OF CONFORMITY

We, TEAC EUROPE GmbH, Bahnstrasse 12, 65205 Wiesbaden-Erbenheim, Germany declare in own responsibility, the TEAC product described in this manual is in compliance with the corresponding technical standards.



IMPORTANT SAFETY INSTRUCTIONS

- 1 Read these instructions.
 - 2 Keep these instructions.
 - 3 Heed all warnings.
 - 4 Follow all instructions.
 - 5 Do not use this apparatus near water.
 - 6 Clean only with dry cloth.
 - 7 Do not block any ventilation openings. Install in accordance with the manufacturer's instructions.
 - 8 Do not install near any heat sources such as radiators, heat registers, stoves, or other apparatus (including amplifiers) that produce heat.
 - 9 Do not defeat the safety purpose of the polarized or grounding-type plug. A polarized plug has two blades with one wider than the other. A grounding type plug has two blades and a third grounding prong. The wide blade or the third prong are provided for your safety. If the provided plug does not fit into your outlet, consult an electrician for replacement of the obsolete outlet.
 - 10 Protect the power cord from being walked on or pinched particularly at plugs, convenience receptacles, and the point where they exit from the apparatus.
 - 11 Only use attachments/accessories specified by the manufacturer.
 - 12 Use only with the cart, stand, tripod, bracket, or table specified by the manufacturer, or sold with the apparatus. When a cart is used, use caution when moving the cart/apparatus combination to avoid injury from tip-over.
 - 13 Unplug this apparatus during lightning storms or when unused for long periods of time.
 - 14 Refer all servicing to qualified service personnel. Servicing is required when the apparatus has been damaged in any way, such as power-supply cord or plug is damaged, liquid has been spilled or objects have fallen into the apparatus, the apparatus has been exposed to rain or moisture, does not operate normally, or has been dropped.
- The apparatus draws nominal non-operating power from the AC outlet with its POWER or STANDBY/ON switch not in the ON position.



- The mains plug is used as the disconnect device, the disconnect device shall remain readily operable.
- Caution should be taken when using earphones or headphones with the product because excessive sound pressure (volume) from earphones or headphones can cause hearing loss.
- If you are experiencing problems with this product, contact TEAC for a service referral. Do not use the product until it has been repaired.

CAUTION

- Do not expose this apparatus to drips or splashes.
- Do not place any objects filled with liquids, such as vases, on the apparatus.
- Do not install this apparatus in a confined space such as a book case or similar unit.
- The apparatus should be located close enough to the AC outlet so that you can easily grasp the power cord plug at any time.
- If the product uses batteries (including a battery pack or installed batteries), they should not be exposed to sunshine, fire or excessive heat.
- CAUTION for products that use replaceable lithium batteries: there is danger of explosion if a battery is replaced with an incorrect type of battery. Replace only with the same or equivalent type.

CAUTIONS ABOUT BATTERIES

This product uses batteries. Misuse of batteries could cause a leak, rupture or other trouble. Always abide by the following precautions when using batteries.

- Never recharge non-rechargeable batteries. The batteries could rupture or leak, causing fire or injury.
- When installing batteries, pay attention to the polarity indications (plus/minus (+/-) orientation), and install them correctly in the battery compartment as indicated. Putting them in backward could make the batteries rupture or leak, causing fire, injury or stains around them.
- When you store or dispose batteries, isolate their terminals with insulation tape or something like that to prevent them from contacting other batteries or metallic objects.
- When throwing used batteries away, follow the disposal instructions indicated on the batteries and the local disposal laws.

- Do not use batteries other than those specified. Do not mix and use new and old batteries or different types of batteries together. The batteries could rupture or leak, causing fire, injury or stains around them.
- Do not carry or store batteries together with small metal objects. The batteries could short, causing leak, rupture or other trouble.
- Do not heat or disassemble batteries. Do not put them in fire or water. Batteries could rupture or leak, causing fire, injury or stains around them.
- If the battery fluid leaks, wipe away any fluid on the battery case before inserting new batteries. If the battery fluid gets in an eye, it could cause loss of eyesight. If fluid does enter an eye, wash it out thoroughly with clean water without rubbing the eye and then consult a doctor immediately. If the fluid gets on a person's body or clothing, it could cause skin injuries or burns. If this should happen, wash it off with clean water and then consult a doctor immediately.
- The unit power should be off when you install and replace batteries.
- Remove the batteries if you do not plan to use the unit for a long time. Batteries could rupture or leak, causing fire, injury or stains around them. If the battery fluid leaks, wipe away any fluid on the battery compartment before inserting new batteries.
- Do not disassemble a battery. The acid inside the battery could harm skin or clothing.

■ For European Customers

Disposal of electrical and electronic equipment

- All electrical and electronic equipment should be disposed of separately from the municipal waste stream via designated collection facilities appointed by the government or the local authorities.
- By disposing of the electrical and electronic equipment correctly, you will help save valuable resources and prevent any potential negative effects on human health and the environment.
- Improper disposal of waste equipment can have serious effects on the environment and human health as a result of the presence of hazardous substances in electrical and electronic equipment.
- The crossed out wheeled dust bin symbol indicates that electrical and electronic equipment must be collected and disposed of separately from household waste.



- The return and collection systems are available to the end users. For more detailed information about disposal of old electrical and electronic equipment, please contact your city office, waste disposal service or the shop where you purchased the equipment.

Disposal of batteries and/or accumulators

- Waste batteries and/or accumulators should be disposed of separately from the municipal waste stream via designated collection facilities appointed by the government or the local authorities.
- By disposing of waste batteries and/or accumulators correctly, you will help save valuable resources and prevent any potential negative effects on human health and the environment.
- Improper disposal of waste batteries and/or accumulators can have serious effects on the environment and human health as a result of the presence of hazardous substances in batteries and/or accumulators.
- The crossed out wheeled dust bin symbol indicates that batteries and/or accumulators must be collected and disposed of separately from household waste. If the battery or accumulator contains more than the specified values of lead (Pb), mercury (Hg), and/or cadmium (Cd) defined in the Battery Directive (2006/66/EC), then the chemical symbols for lead (Pb), mercury (Hg) and/or cadmium (Cd) will be indicated beneath the crossed out wheeled dust bin symbol.
- The return and collection systems are available to the end users. For more detailed information about disposal of waste batteries and/or accumulators, please contact your city office, waste disposal service or the shop where you purchased them.



Pb, Hg, Cd

Contents

Introduction.....	7
Features.....	7
Included items.....	7
Conventions used in this manual.....	8
Precautions for placement and use.....	8
Cleaning the unit.....	8
Beware of condensation.....	8
Using the TEAC Global Site.....	8
User registration.....	8
Names and functions of parts.....	9
Front.....	9
Rear.....	9
Sides.....	10
Preparation.....	11
Power sources.....	11
Using a AAA battery.....	11
Power supply status indicator.....	11
Connecting with a microphone.....	11
Turning the unit on and off.....	11
Turning the unit on.....	11
Shutting down.....	12
Turning off automatically.....	12
Installing a microSD card.....	12
Handling microSD cards.....	12
Precautions when handling microSD cards.....	12
Recording durations when using microSD cards.....	13
Connecting with a computer.....	13
Starting and stopping recording.....	14
Playback and searching backward/forward.....	14
Checking the remaining recording capacity of the microSD card.....	15
Making menu settings.....	15
Menu structure.....	16
Messages.....	20

Making settings using a text file.....	21
Settings file.....	21
Settings file format explanation.....	21
Specifications.....	23
Ratings.....	23
Input/output ratings.....	23
Audio performance.....	23
General.....	23
Dimensional drawings.....	24

Introduction

Thank you very much for purchasing this TASCAM product.

Before using this unit, read this Owner's Manual carefully so that you will be able to use it correctly and enjoy working with it for many years. After you have finished reading this manual, please keep it in a safe place for future reference.

You can also download this Owner's Manual from the TEAC Global Site (<http://teac-global.com/>).

Features

- Connect directly to mic XLR connectors (support for dynamic mics)
- Uses microSD and micro SDHC cards as recording media
- Recording linear PCM (WAV/BWF) files in 44.1/48kHz 16/24-bit, mono/poly formats possible.
- Time track incrementing function allows a recording to be split by creating a new file at regular intervals (about 15 minutes) without interrupting recording.
- Limiter function automatically reduces parts where the input level is too high to suitable levels.
- Low cut filter is useful for reducing low-frequency noise.
- Dual recording function allows two files to be recorded simultaneously at different levels. (Only when file type is set to MONO.)
- Sliding switch for recording operation protects against misoperation.
- File name format can be set to use a user-defined word or the date.
- The built-in clock time and function items can be set using the system file (text file).
- Playback functions allow recorded files to be checked immediately.
- Secondary lithium battery used to save time information.
- A 3.5mm (1/8") headphone jack is built-in.
- The 96×16 OLED display has a wide viewing angle and is easy to read.
- Micro-B USB 2.0 port.

Included items

This product includes the following items.

Keep the packing materials for transportation in the future.

Please contact TASCAM Customer Support (see back cover) if any of these items are missing or have been damaged during transportation.

- Main unit..... × 1
- USB cable..... × 1
- Owner's Manual (this document) including warranty..... × 1

Conventions used in this manual

The following conventions are used in this manual.

- When we refer to buttons, connectors and other parts of this unit and other equipment, we use a bold font like this: **MENU** button.
- When we show messages, for example, that appears on the unit's display, the typeface looks like this: **DN**.
- The area of the display that is shown in inverse (light on dark) is referred to as the cursor or as being highlighted.
- "microSD/microSDHC memory card" is sometimes abbreviated as "microSD card".
- Additional information is provided as necessary as tips, notes and cautions.

TIP

These are tips about how to use the unit.

NOTE

These provide additional explanations and describe special cases.

CAUTION

Failure to follow these instructions could result in injury, damage to equipment or lost recording data, for example.

Precautions for placement and use

- The operating temperature range of this unit is 0–40 °C.
- Do not install this unit in the following types of locations. Doing so could degrade the sound quality and/or cause malfunctions.
 - Places with significant vibrations
 - Near windows or other places exposed to direct sunlight
 - Near heaters or other extremely hot places
 - Extremely cold places
 - Places with bad ventilation or high humidity
 - Very dusty locations
 - Places exposed directly to rain or other water
- Do not place this unit on top of a power amplifier or other device that generates heat.

Cleaning the unit

Use a dry soft cloth to wipe the unit clean. Do not wipe with chemical cleaning cloths, thinner, alcohol or other chemical agents. Doing so could damage the surface or cause discoloration.

Beware of condensation

If the unit is moved from a cold to a warm place, or used after a sudden temperature change, there is a danger of condensation; vapor in the air could condense on the internal mechanism, making correct operation impossible. To prevent this, or if this occurs, let the unit sit for one or two hours at the new room temperature before using it.

Using the TEAC Global Site

You can download this Owner's Manual necessary for this unit from the TEAC Global Site (<http://teac-global.com/>).

1. Open the TEAC Global Site (<http://teac-global.com/>).
2. In the TASCAM Downloads section, click the desired language to open the Downloads website page for that language.

NOTE

*If the desired language does not appear, click **Other Languages**.*

3. Click the product name in the "Search by Model Name" section to open the Downloads page for that product.
4. Select and download the Owner's Manual that are needed.

User registration

Customers in the USA, please visit the TASCAM website (<http://tascam.com/>) to register as a user online.

Names and functions of parts

Front

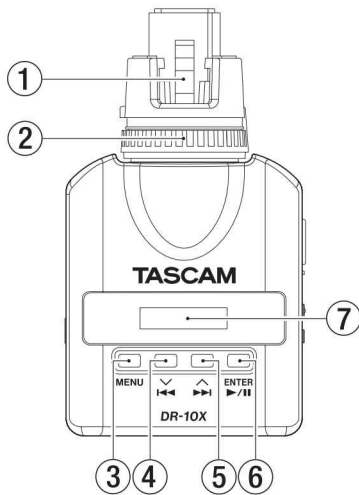

① XLR connector

Connect this to a dynamic mic with an XLR connector.

This can also be used as an external input. In this case, it will be a HOT pin unbalanced input. See the "Input/output ratings" on page 23 for input level specifications. (1: GND, 2: HOT, 3: COLD)

② Clamp nut

Use this to secure an XLR dynamic mic.

③ MENU button

- When the Home Screen is open, press the **MENU** button to open the Menu Screen. When the Menu Screen is open, press the **MENU** button again to return to the Home Screen.
- When a setting item is shown, press the **MENU** button to return to the Menu Screen.

④ I◀◀ [∨] button

- During playback or when stopped in the middle of a file, press the I◀◀ [∨] button to return to the beginning of the file.
- Press when located at the beginning of a file to skip to the beginning of the previous file. Press and hold this button during playback to search backward.
- When the Menu Screen is open, press the I◀◀ [∨] button to open the Menu Screen.
- When a setting item is shown, press the I◀◀ [∨] button to move the cursor left.
- When inputting a file name, use this to select characters.

⑤ ▶▶ [∧] button

- During playback or when stopped in the middle of a file, press the ▶▶ [∧] button to skip to the beginning of the next file. Press and hold this button during playback to search forward.
- When the Menu Screen is open, press the ▶▶ [∧] button to select a menu item.
- When a setting item is shown, press the ▶▶ [∧] button to move the cursor right.
- When inputting a file name, use this to select characters.

⑥ ▶ / II [ENTER] button

- When the Home Screen is open, press the ▶ / II [ENTER] button to start file playback.
- When the Menu Screen is open or a setting item is shown, press the ▶ / II [ENTER] button to confirm the selected item. Use this also to respond to a confirmation message.

⑦ Display

Shows a variety of information.

Rear

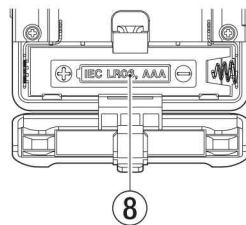

⑧ Battery compartment and cover

Install one AAA battery in this compartment to power the unit.

Sides

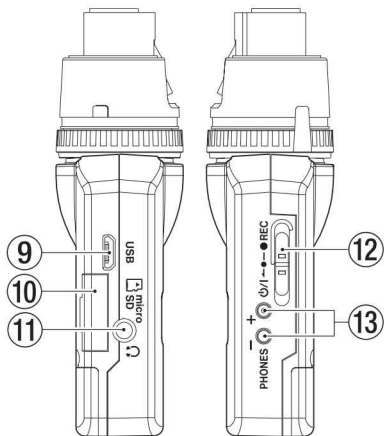

9 USB port

Use the included USB cable to connect this Micro-B USB port with a computer. When connected, the USB SELECT screen appears to allow selection of bus power supply or data transmission by USB.

CAUTION

The unit should be connected directly to the computer, not through a USB hub.

10 microSD card slot

Use this slot to insert and remove microSD cards.

Open the microSD card slot cover on the left side. (See "Installing a microSD card" on page 12.)

11 Headphones jack

Connect stereo headphones to this stereo mini jack.

12 P/I \leftarrow \bullet \rightarrow **REC** switch

Slide this switch toward P/I and hold it for about one second to turn the unit on/off.

- Slide and hold this switch toward **REC** for about one second to start recording.
- When recording, slide and hold this switch toward **REC** for about one second to stop recording.

NOTE

The one-second delay is intended to prevent accidental operation.

13 PHONES [+]/[-] buttons

Use the + and - buttons to adjust the volume output from the headphones jack.

During adjustment, a volume indicator will appear on the display.

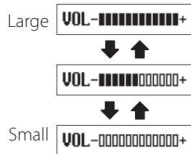

CAUTION

Before connecting headphones, lower the PHONES volume to the minimum level. Failure to do so might cause sudden loud noises, which

could harm your hearing or result in other trouble.

Do not apply excessive force to the jack when connecting and using headphones. Be careful, because the application of unintended force, particularly when using a mini jack, could damage the equipment.

Preparation

Power sources

This unit can operate on one AAA battery or USB bus power using the included USB cable.

This unit can use an alkaline, Ni-MH or lithium AAA battery.

Using a AAA battery

Open the battery compartment cover on the back of the unit. Install 1 AAA battery in the compartment with the \oplus and \ominus marks as shown. Then, close the battery compartment cover.

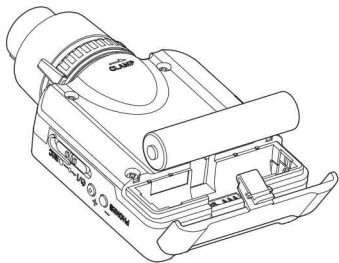

When using a AAA battery, set the type of battery in order to accurately show the amount of power remaining and allow the unit to accurately determine whether power is available for proper operation. (See "Making menu settings" on page 15.)



CAUTION

- AAA manganese dry cell batteries cannot be used with this unit.
- This unit cannot recharge AAA Ni-MH batteries. Use a commercially-available recharger.

Power supply status indicator

When operating on battery power, a battery icon appears at the top right of the display.

The battery icon shows the amount of power remaining in bars    .

The battery is almost dead and the power will soon turn off if the  icon with no bars blinks. When operating on USB bus power, the  icon appears.

Connecting with a microphone

Connect the XLR connector to the microphone.

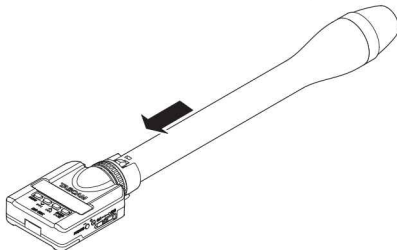

NOTE

- Turn the clamp nut in the opposite direction of CLAMP \rightarrow and then attach the mic to the connector.
- If the connection is loose between this recorder and the mic, turn the clamp nut in the direction of the arrow to secure it.
- Do not hold the DR-10X when it is connected to a mic. (Hold the mic.)

Clamp nut

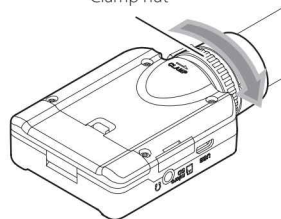

Turning the unit on and off

CAUTION

Do not wear connected headphones when turning the unit on and off. A loud noise could damage to the speakers or harm your ears.

Turning the unit on

When the unit is off, slide the P/I \leftarrow \bullet \rightarrow \bullet REC switch toward P/I and hold it for about one second until the TASCAM DR-10 startup screen appears and the unit starts.

The Home Screen shown below appears after the unit starts up.



NOTE

If the unit is not used for a few minutes, the display will appear as below in screensaver mode.



Shutting down

When the unit is on, slide the **⏻/1 ← ● ● REC** switch toward **⏻/1** and hold it for about one second until the display becomes unlit and the unit turns off.

CAUTION

*Always use the **⏻/1 ← ● ● REC** switch to turn the unit off.*

When the unit is on, do not remove the battery or disconnect the USB cable if using USB bus power. Doing so will cause all recordings, settings and other data to be lost. Lost data and settings cannot be restored.

Turning off automatically

When operating on battery power and the **AUTO PWR SAVE** item on the Menu Screen is set to ON, if the unit is stopped and no operation has occurred for about 10 minutes, the unit will turn itself off automatically.

NOTE

*When the unit is turned on for the first time (or when the built-in clock is reset after being left unused without a battery), the Menu Screen **DATE/TIME** item appears after the start-up screen to allow the date and time to be set.*

*For details about how to set it, see the **DATE/TIME** item in "Menu structure" on page 16.*

Installing a microSD card

Open the microSD card slot cover on the left side.

- Inserting the microSD card
Insert the microSD Card into the slot in the direction of the arrow as shown in the following illustration until it clicks into place.
- Removing the microSD card
Press the microSD card in gently and then release it to allow it to come out.

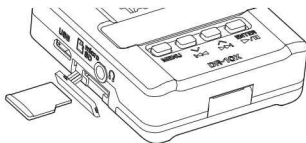

CAUTION

In order to use a microSD card in this unit, you must format it first. (See "Making menu settings" on page 15.)

- After formatting a microSD card, the display will show the following when the unit is turned on.



- If no microSD card has been inserted, the display will show the following when the unit is turned on.



See the following section for information about handling microSD cards.

Handling microSD cards

Precautions when handling microSD cards

This unit uses microSD/microSDHC cards for recording and playback.

It supports microSD cards that are 64 MB – 2 GB and microSDHC cards that are 4 GB – 32 GB.

A list of microSD cards that have been confirmed for use with this unit can be found on the TEAC Global Site (<http://teac-global.com/>). microSD/microSDHC cards are delicate media. In order to avoid damaging a card or the card slot, please take the following precautions when handling them.

- Do not leave them in extremely hot or cold places.
- Do not leave them in extremely humid places, and do not let them become wet.
- Do not put things on top of them or twist them.
- Do not hit them.
- Do not remove or insert a card during data transmission or other access.

Recording durations when using microSD cards

The table below shows maximum recording times on microSD/microSDHC cards of different capacities.

microSD/ microSDHC card capacity (hours:minutes)	24-bit/48kHz WAV recording setting	
	DUAL REC MODE off	DUAL REC MODE on or FILE TYPE POLY
1GB	2:04	1:02
2GB	4:08	2:04
4 GB	8:16	4:08
8GB	16:32	8:16

- The recording times shown above are estimates. They might differ depending on the microSD/microSDHC card in use.
- The recording times shown above are not continuous recording times, but rather they are the total possible recording times for the microSD/microSDHC card.

Connecting with a computer

Connect the unit to a computer using the included USB cable as shown in the illustration.

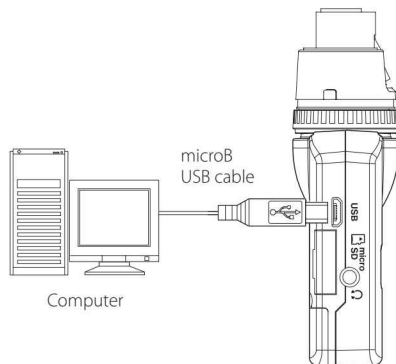

Whether the power is on or off, when connected, the **POWER/STORAGE** screen appears to allow selection of bus power supply or USB connection with the computer.

Use the **◀◀ [V]** and **▶▶ [^]** buttons to select (highlight) the **POWER** or **STORAGE** item at the bottom of the display, and press the **▶/|| [ENTER]** button.

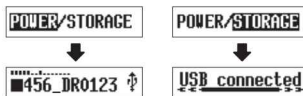

- If **POWER** is selected, power will be supplied from the USB port and the Home Screen will open.

- If **STORAGE** is selected, **USB connected** will appear on the display after the unit connects to the computer without any problems. The unit will be shown on the computer as a USB device named "DR-10". Double-click the "DR-10" drive to open it and show a list of the recording files, so you can retrieve the desired files.

Starting and stopping recording

You can use a single operation to start recording with this unit even when it is off.

■ One touch recording

When the unit is off, slide and hold the $\phi/1$ \leftarrow \bullet \rightarrow **REC** switch toward **● REC** for about one second until the TASCAM DR-10 startup message appears and recording starts.

■ Ordinary recording

To start recording when the unit is on, slide the $\phi/1$ \leftarrow \bullet \rightarrow **REC** switch toward **● REC** for about one second.

■ Stopping recording

Slide the switch toward **● REC** during recording for about one second to stop recording.

The following information appears on the display when stopped, when recording starts and during recording.

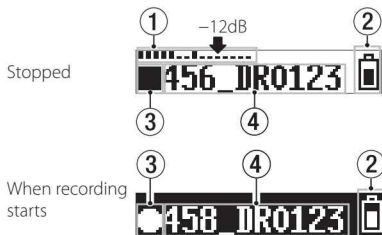

Recording



- ① Level meter
- ② Remaining battery charge
- ③ Recorder operation status
- ④ File name
- ⑤ Elapsed recording time

NOTE

- *The one-second delay is intended to prevent accidental operation.*
- *Without pausing recording, a new file can be created automatically during recording when the file size reaches 2 GB. (Track incrementing)*
- *Set the mic input sensitivity with the MIC GAIN item on the Menu Screen so that that activity of the level meters reaches the arrow (at -12 dB) in the illustration. (See "Menu structure" on page 16.)*

Playback and searching backward/forward

The Home Screen shown below appears after the unit starts up.



■ Starting and stopping playback

When the Home Screen is open and playback is stopped, press the \blacktriangleright / **II** [ENTER] button to start playback. Press this button again to stop playback.

■ Searching backward and forward

During playback, press and hold the \blacktriangleleft [\surd] or \blacktriangleright [\wedge] button to start searching backward or forward. Continue pressing and holding the \blacktriangleleft [\surd] or \blacktriangleright [\wedge] button to accelerate the search speed.

Release the \blacktriangleleft [\surd] or \blacktriangleright [\wedge] button to resume playback.

The display appears as below when playback starts and during playback.

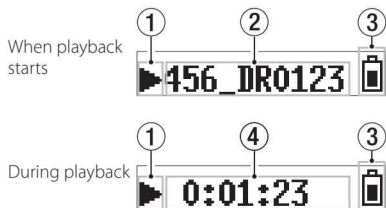

- ① Recorder operation status
- ② Playback file name
- ③ Remaining battery charge
- ④ Elapsed playback time

NOTE

- During playback, press and hold the **MENU** button to show the remaining time of the playing file.

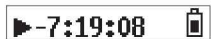

- When searching, <<< or >>> will be shown. If the search speed is increased, this will change to <<<< or >>>>.



Checking the remaining recording capacity of the microSD card

When stopped or recording, press and hold the **MENU** button to show the remaining recording capacity of the microSD.

Making menu settings

Follow these procedures to change various unit settings.

1. When the Home Screen is open, press the **MENU** button to open the Menu Screen.
2. Use the <<< [V] and >>> [^] buttons to select the menu item to set and press the > / || [ENTER] button to show the setting item.
3. Use the <<< [V] and >>> [^] buttons to change the setting.
4. Press the > / || [ENTER] button to confirm the setting and return to the Menu Screen.
5. Repeat steps 2 to 4 as necessary to set each item.
6. When finished, press the **MENU** button to return to the Home Screen.

Menu structure

Press the **MENU** button to open the Menu Screen. This list provides an overview of the various menu items.

Menu item	Summary	Setting items (default value underlined)	Explanation
MIC GAIN	External input/ mic gain settings	EXT/ <u>LO</u> /MID/HI	Use to set external input or the mic input sensitivity. EXT: external input (HOT pin unbalanced input) LO/MID/HI: Mic input sensitivity (balanced input) NOTE <i>If the AUTO LEVEL item on the menu screen is set to ON, it will be reset to OFF when the MIC GAIN setting is changed. When this happens, AUTO LVL Cancel will appear in a pop-up message.</i>
LOW CUT	Low cut filter	<u>OFF</u> /ON	Turns the mic input low-cut filter on or off. The cutoff frequency is 120 Hz.
LIMITER	Input limiter	<u>OFF</u> /ON	This function prevents distortion when signals that are too loud are input suddenly. Turns this function on or off. Distortion of sounds may occur when signals that are very loud are input even if the LIMITER function is activated. In such a case, use the Menu Screen MIC GAIN item to lower the mic input sensitivity, or increase the distance from the sound source.
AUTO LEVEL	Automatic level adjustment	<u>OFF</u> /ON	When the input sound level is too low or too high, the recording volume will be increased or decreased automatically to an appropriate level.
FS SAMPLE	Sampling frequency	44.1kHz / <u>48kHz</u>	Use to set the sampling frequency setting.
BIT LENGTH	Quantization bit depth	16bit / <u>24bit</u>	Use to set the quantization bit depth.
FILE TYPE	Recording file type	<u>MONO</u> / POLY	Use to set the recording file type. MONO: Record mono files. POLY: Record stereo files (with the same data on both left and right channels). NOTE <i>If the DUAL REC MODE item on the menu screen is set to ON, it will be reset to OFF when the FILE TYPE setting is changed to POLY. When this happens, DUAL REC Cancel will appear in a pop-up message.</i>

Menu item	Summary	Setting items (default value underlined)	Explanation						
DUAL REC MODE	Dual recording	<u>OFF</u> /ON	<p>This recorder can simultaneously record a second recording at a different input level along with the regular recording. For example, you can make an ordinary recording with the input level set as high as possible and simultaneously record at a slightly lower input level (–6 dB) for security. Two recorded files (one with higher input level and one with lower input level) are saved individually.</p> <p>Dual recording file names</p> <p>Dual recording will create two files simultaneously.</p> <p>The name of the second file created by dual recording has “_D” added to the file name of the ordinary recording.</p> <table style="width: 100%; border: none;"> <tr> <td style="text-align: center;">Ordinary recording file name</td> <td style="text-align: center;">Dual recording file name</td> </tr> <tr> <td style="text-align: center;">002_TASCAM.WAV</td> <td style="text-align: center;">002_TASCAM_D.WAV</td> </tr> <tr> <td style="text-align: center;">① ②</td> <td style="text-align: center;">① ② ③</td> </tr> </table> <p>① 002 (basic recording file number)</p> <p>② TASCAM (according to the WORD setting of the FILE NAME item on the Menu Screen)</p> <p>③ D (dual recording file with lower input level (–6 dB) setting)</p> <p>NOTE</p> <p><i>If the FILE TYPE item on the menu screen is set to POLY, it will be reset to MONO when the DUAL REC MODE setting is changed to ON. When this happens, FILE TYPE Cancel will appear in a pop-up message.</i></p>	Ordinary recording file name	Dual recording file name	002_TASCAM.WAV	002_TASCAM_D.WAV	① ②	① ② ③
Ordinary recording file name	Dual recording file name								
002_TASCAM.WAV	002_TASCAM_D.WAV								
① ②	① ② ③								
TIME TRK INC	Timed track incrementation	<u>OFF</u> /ON	Without pausing recording, a new file can be created automatically during recording after about 15 minutes have elapsed.						
WARNING BEEP	Warning sound	<u>OFF</u> / ON	<p>If set to ON, warning sounds (beeping) will be output from the headphone jack every few seconds when the following conditions apply.</p> <ul style="list-style-type: none"> • The battery charge is low (battery icon appears empty) • The microSD card has little open-space (when the remaining recording time is about 10 minutes or less) • Recording cannot be started (because the number of recorded files exceeds the limit of 1000 or the microSD card has a problem, for example) 						
AUTO PWR SAVE	Automatic power off setting	<u>OFF</u> /ON	Turns this function on or off. When operating on battery power and this function is on, if the unit is stopped when no operation has occurred for about 10 minutes, the unit will turn itself off automatically.						

Menu item	Summary	Setting items (default value underlined>	Explanation
FILE NAME TYP	File name type setting	<u>WORD/DATE</u>	You can select the format of names given to files recorded by this unit. WORD: The 6 characters set using the Menu Screen FILE NAME item is used for file names. Example: 000_ <u>DR0000</u> .wav DATE: The date is used as the file name (in yymmdd format). Example: 000_110101.wav
FILE NAME	Set the file name	[DR0000]	Press the ►/II [ENTER] button to move the cursor from left to right one character at a time. When the cursor is at the character on the far right, press the ►/II [ENTER] button to confirm the file name and return to the Menu Screen. Use the I◀◀ [∨] and ▶▶I [∧] buttons to change the character at the cursor position. In addition to the alphabet and numbers, the following characters can be used: ! # \$ % & ' () + , - . ; = @ [] ^ _ ` { } TIP <i>When using more than one of these units, you can set the file name in advance to identify which units were used to record files. This can be convenient when editing files.</i> Example <i>Units: 1st (DR0001), 2nd (DR0002), 3rd (DR0003)... 10th (DR0010)</i> <i>File names: 000_ <u>DR0001</u>.wav, 000_ <u>DR0002</u>.wav, 000_ <u>DR0003</u>.wav... 000_ <u>DR0010</u>.wav</i>
FORMAT SD	Format microSD card	<u>Sure? YES/NO</u>	Use this to format the microSD card in the unit. YES: Start formatting the card. After formatting completes, the Menu Screen reappears. NO: Return to the Menu Screen.
BATTERY TYPE	Battery setting	<u>ALK/NiMH/LITH</u>	Use this to set the type of battery used. This setting is used to show the amount of remaining battery charge and determine if the unit has enough power for normal operation. ALK: Alkaline AAA battery LITH: Lithium AAA battery NiMH: Ni-MH AAA battery

Menu item	Summary	Setting items (default value underlined)	Explanation
DATE/TIME	Internal clock setting Year/month/ date/hour/ minute	YY-MM-DD HH:MM	<p>"YY-MM-DD HH:MM"</p> <p>① ② ③ ④ ⑤</p> <p>①: YY (year), ②: MM (month), ③: DD (date), ④: HH (hour), ⑤: MM (minute)</p> <p>Press the ► / II [ENTER] button to move the cursor from left to right: ① → ② → ③ → ④ → ⑤.</p> <p>When the cursor is at ⑤ on the far right, press the ► / II [ENTER] button to confirm the date and time and return to the Menu Screen.</p> <p>Use the ◀◀ [∨] and ▶▶ [∧] buttons to change the number at the cursor position.</p>
SYSTEM INIT	Restore factory default settings	Sure? YES/ <u>NO</u>	<p>Use this to restore the various settings of this unit to their default values (factory settings).</p> <p>YES: Initialize the settings. After initializing completes, the Menu Screen reappears.</p> <p>NO: Return to the menu screen.</p>
VERSION INFO	Shows the firmware version	Vx.xx xxxx	<p>This is the firmware version used by the unit.</p> <p>When the version is being shown, press the ► / II [ENTER] button to return to the Menu Screen.</p>

Messages

The following is a list of the pop-up messages.

Message	Meaning and response
Battery Empty	The battery is almost out of power. Replace the battery.
Card Error	The microSD card could not be recognized properly. Change the microSD card.
Card Full	The microSD card has no remaining capacity. Erase unnecessary files or move them to a computer to make open space.
File Full	The total number of recording files exceeds the limit of 1000. Erase unnecessary files or move them to a computer to make open space.
Format Error	The microSD card is not formatted properly or the formatting is broken. Use the DR-10X to format the microSD card.
Invalid Card	The card might be abnormal. Change the microSD card.
No Music File	There is no file that can be played back on the microSD card.
Non-Supported	The audio file is not a supported format or is broken.
Write Timeout	Writing to the microSD card timed out. Change to a card with faster writing, or backup files on the card to a computer and format the card.
Player Error	If any of these errors occurs, turn the unit off once and restart it.
Write Failed	If the unit cannot be turned off, remove the battery or disconnect the USB cable if it is being operated on USB bus power. If these error messages continue to appear frequently, please contact a TEAC Service Center (listed on page 2 of this manual).

Making settings using a text file

When this unit is turned on, it automatically reads a settings file (text format) stored on the microSD card and applies its menu item settings.

NOTE

After applying the settings, the settings file is deleted.

Settings file

- File name: DR-10_SysPara.txt
 - File storage location: The settings file is placed in the root directory of the microSD card.
-

Settings file format explanation

The order that settings are notated does not matter.

There is no need to notate all the settings. You can notate only the settings that you want to set.

NOTE

- *If there is an error in notation, that setting will not be applied to the unit.*
- *If the FILE TYPE setting is POLY and the DUAL REC MODE setting is ON, the menu item setting that comes later in the order written in the setting file will be effective.*

■ Tag definition

<dr10_syspara> (required)

These are tags that identify setting statements. All setting elements must be written between <dr10_syspara> and </dr10_syspara> tags.

<mic_gain>

This indicates the Menu Screen MIC_GAIN setting. Notate it as "ext", "low", "mid" or "hi".

Example: <mic_gain>mid</mic_gain>

<low_cut>

This indicates the Menu Screen LOW_CUT setting. Notate it as "off" or "on".

Example: <low_cut>off</low_cut>

<limiter>

This indicates the Menu Screen LIMITER setting. Notate it as "off" or "on".

Example: <limiter>off</limiter>

<auto_level>

This indicates the Menu Screen AUTO_LEVEL setting. Notate it as "off" or "on".

Example: <auto_level>off</auto_level>

<fs_sample>

This indicates the Menu Screen FS_SAMPLE setting. Notate it as "44.1" or "48".

Example: <fs_sample>48</fs_sample>

<bit_length>

This indicates the Menu Screen BIT_LENGTH setting. Notate it as "16bit" or "24bit".

Example: <bit_length>24bit</bit_length>

<file_type>

This indicates the Menu Screen FILE_TYPE setting. Notate it as "MONO" or "POLY".

Example: <file_type>MONO</file_type>

<dual_rec>

This indicates the Menu Screen DUAL_REC_MODE setting. Notate it as "off" or "on".

Example: <dual_rec>off</dual_rec>

<time_track_inc>

This indicates the Menu Screen TIME_TRK_INC setting. Notate it as "off" or "on".

Example: <time_track_inc>off</time_track_inc>

<beep>

This indicates the Menu Screen WARNING_BEEP setting. Notate it as "off" or "on".

Example: <beep>off</beep>

<auto_pwr_save>

This indicates the Menu Screen AUTO_PWR_SAVE setting. Notate it as "off" or "on".

Example: <auto_pwr_save>on</auto_pwr_save>

<file_name_type>

This indicates the Menu Screen FILE_NAME_TYP setting. Notate it as "word" or "date".

Example: <file_name_type>date</file_name_type>

<file_name>

This indicates the Menu Screen **FILE NAME** setting. Use 6 characters to set the file name.

Example: <file_name>DR0000</file_name>

<battery_type>

This indicates the Menu Screen **BATTERY TYPE** setting. Notate it as "alkali", "ni-mh" or "lithium".

Example: <battery_type>alkali</battery_type>

<date>

This indicates the Menu Screen **DATE/TIME** date setting, which is used for the built-in clock. Notate it with 10 half-width (ordinary) characters including hyphens in a "YYYY-MM-DD" format.

Example: <date>2014-08-27</date>

<time>

This indicates the Menu Screen **DATE/TIME** time setting, which is used for the built-in clock. Notate it with 8 half-width (ordinary) characters including colons in a "HH:MM:SS" format using 24-hour time.

Example: <time>23:59:59</time>

<battery_type>alkali</battery_type>

<date>2014-08-27</date>

<time>23:59:59</time>

</dr10_syspara>

- Example with only the time setting

<dr10_syspara>

<time>23:59:59</time>

</dr10_syspara>

■ Sample notations

- Example with all menu items

<dr10_syspara>

<mic_gain>low</mic_gain>

<low_cut>off</low_cut>

<limiter>off</limiter>

<auto_level>off</auto_level>

<fs_sample>48</fs_sample>

<bit_length>24bit</bit_length>

<file_type>MONO</file_type>

<dual_rec>off</dual_rec>

<time_track_inc>off</time_track_inc>

<beep>off</beep>

<auto_pwr_save>on</auto_pwr_save>

<file_name_type>date</file_name_type>

<file_name>DR0000</file_name>

Specifications

Ratings

■ Recording media

microSD card (64 MB–2 GB)
microSDHC card (4 GB–32 GB)

■ Recording/playback formats

44.1/48kHz 16/24-bit, mono/poly BWF

Input/output ratings

■ Analog input

Mic jack

Connector

XLR JACK (female) (1: GND, 2: HOT, 3: COLD)

When MIC GAIN external input (EXT) selected (HOT pin unbalanced input)

Maximum input level: –8 dBu

Nominal input level: –24 dBu

When MIC GAIN mic input (LO/MID/HI) selected (balanced input)

Maximum input level: –31 dBu

Minimum input level: –63 dBu

Mic input gain

LO: +29 dB

MID: +35 dB

HI: +45 dB

Input impedance: 10 kΩ or more

■ Analog output

Headphones jack

Connector: 1/8" (3.5mm) stereo phone (dual mono audio output)

Audio performance

■ IN → PHONES (input monitoring output, 10kΩ load)

When MIC GAIN external input (EXT) selected (HOT pin unbalanced input)

Frequency response: 20 Hz – 22 kHz +1/–2 dB

Distortion: 0.05% (1kHz sine wave, at maximum input level)

S/N ratio: 92 dB or higher (PHONES volume max)

When MIC GAIN mic input (LO/MID/HI) selected (balanced input)

Frequency response: 20 Hz – 22 kHz +1/–2 dB

Distortion: 0.05% (1kHz sine wave, at maximum input level)

S/N ratio: 80 dB or higher (PHONES volume max, LO selected)

General

■ Power

1 AAA battery (alkaline, NiMH or lithium)

USB bus power from a computer

■ Power consumption

0.65 W (maximum)

■ Current consumption (USB bus power)

0.25A(maximum)

■ Battery operation time (continuous operation)

Using an alkaline battery (EVOLTA)

	Format	Operation time	Note
Recording	48kHz/24-bit WAV	About 10.0 hours	Headphones not connected Limiter: off Dual recording: off File type: mono

Recording: JEITA recording time

Using NiMH battery (eneloop)

	Format	Operation time	Note
Recording	48kHz/24-bit WAV	About 8.0 hours	Headphones not connected Limiter: off Dual recording: off File type: mono

Recording: JEITA recording time

Using lithium battery (Energizer ULTIMATE LITHIUM)

	Format	Operation time	Note
Recording	48kHz/24-bit WAV	About 15.5 hours	Headphones not connected Limiter: off Dual recording: off File type: mono

Recording: JEITA recording time

■ Date and time data retention

Secondary lithium battery x1 (built-in)

■ Dimensions

52 x 94.4 x 28 mm (width x height x depth, excluding protrusions)

24 TASCAM DR-10X

■ Weight

68.3 g (including batteries)/56.3 g (not including batteries)

■ Operating temperature range

0°C–40°C (32°F–104°F)

Dimensional drawings

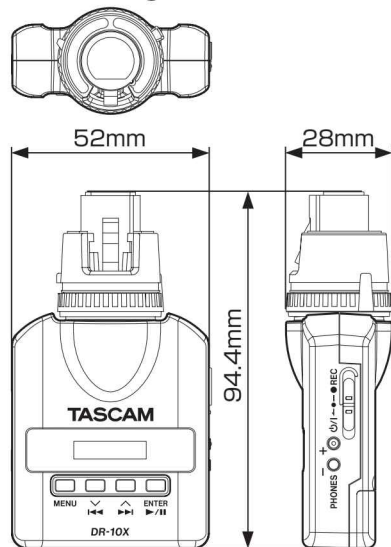

- Illustrations in this manual might differ in part from the actual product.
- Specifications and external appearance might be changed without notification to improve the product.