

LXP15

Professional Passive 2-Way Speaker

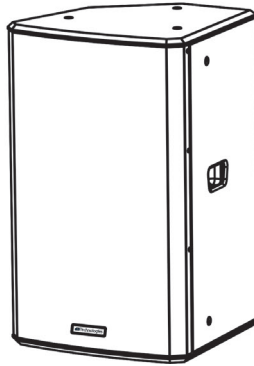

QUICK START USER MANUAL Section 1

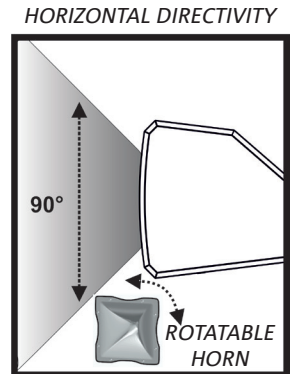
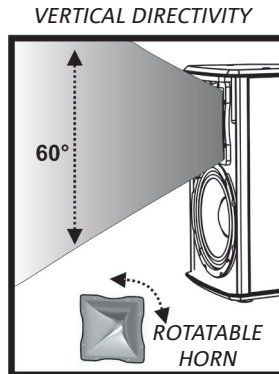
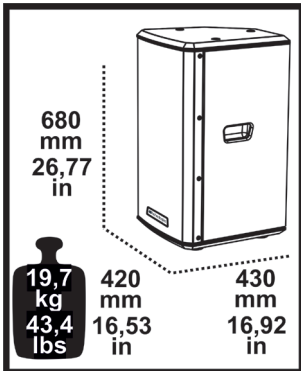

The warnings in this manual must be observed together with the "USER MANUAL - Section 2".

Le avvertenze nel presente manuale devono essere osservate congiuntamente al "MANUALE D'USO - Sezione 2".

Die Warnungen in diesem Handbuch müssen in Verbindung mit der "BEDIENUNGSANLEITUNG - Abschnitt 2" beobachtet werden".

Les avertissements spécifiés dans ce manuel doivent être respectés ainsi que les "CARACTERISTIQUES TECHNIQUES -Section 2"

Las advertencias del presente manual se deben tener en cuenta conjuntamente con las del "MANUAL DEL USUARIO" - Sección 2".

MAIN FEATURES

Type:	2-way wooden passive loudspeaker (weather resistant)
Connector type:	4-pole speakON
Main installation uses:	Wall mounting, pole mounting (36 mm hole), wedge (40°)
Main accessories:	Wall brackets (WBH-LVXP - WBV-LVXP series)

ACOUSTIC SECTION

HF transducer:	1" exit
HF voice coil:	1,35"
LF transducer:	15"
LF voice coil:	2,5"
Frequency response (-10 dB)	58 Hz - 21 kHz
Frequency response (-6 dB)	71 Hz - 17 kHz
Max SPL	129 dB
Rotatable Horn	Yes

SPEAKON AND XLR CONNECTORS

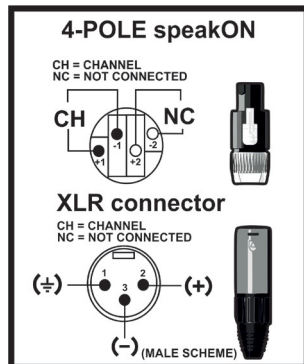

POWER SECTION

Nominal Impedance:	8 Ω
Power Handling (RMS)	400 W
Power Handling (Peak)	800 W

IN/LINK SECTION

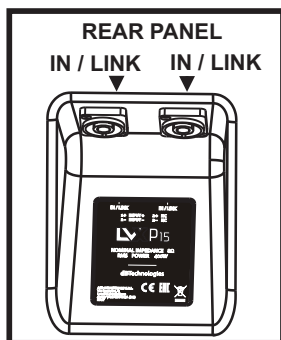

USAGE EXAMPLE (FOR INFORMATION ONLY)

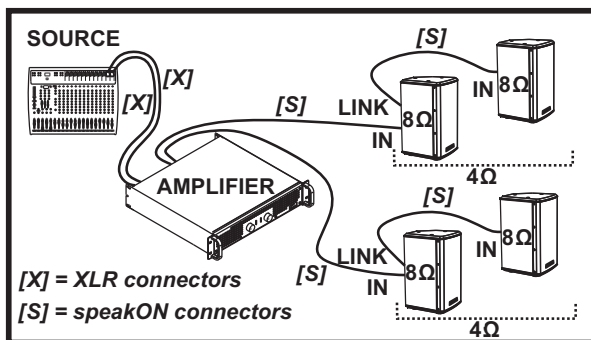

ATTENZIONE: Per l'installazione e l'uso degli accessori è obbligatorio fare riferimento al manuale completo disponibile all'indirizzo: www.dbtechnologies.com. Ogni altro uso è proibito.
CAUTION: For installation and the usage of the accessories is mandatory to refer to the complete user manual, available on: www.dbtechnologies.com, Any other usage is prohibited.

Scan with your QR Reader
App to download the
complete User Manual!



Caratteristiche, specifiche e aspetto dei prodotti sono soggetti a possibili cambiamenti senza previa comunicazione. dBTechnologies si riserva il diritto di apportare cambiamenti o miglioramenti nel design o nelle lavorazioni senza assumersi l'obbligo di cambiare o migliorare anche i prodotti precedentemente realizzati.
 Features, specification and appearance of products are subject to change without notice. dBTechnologies reserves the right to make changes or improvements in design or manufacturing without assuming any obligation change or improve products previously manufactured.