

FLEXSYS FMX15

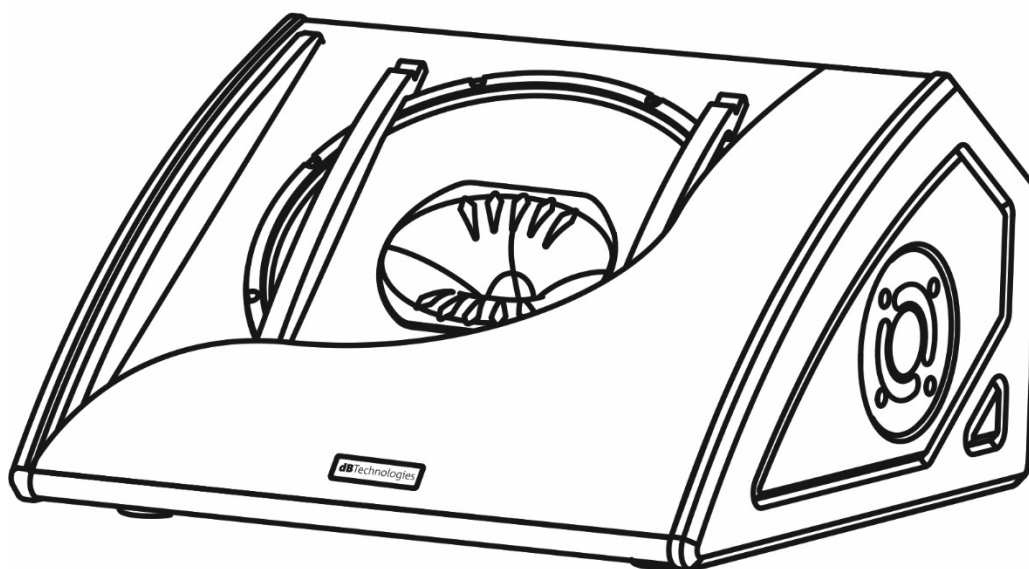

Quick start user manual

Section 1

The warnings in this manual must be observed together with the "USER MANUAL - Section 2".

Le avvertenze nel presente manuale devono essere osservate congiuntamente al "MANUALE D'USO - Sezione 2".

Die Warnungen in diesem Handbuch müssen in Verbindung mit der "BEDIENUNGSANLEITUNG - Abschnitt 2" beobachtet werden".

Les avertissements spécifiés dans ce manuel doivent être respectés ainsi que les "CARACTERISTIQUES TECHNIQUES - Section 2".

Las advertencias del presente manual se deben tener en cuenta conjuntamente con las del "MANUAL DEL USUARIO" - Sección 2".

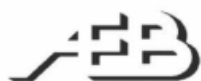

A.E.B. Industriale Srl Via Brodolini, 8 Località Crespellano 40053 VALSAMOGGIA BOLOGNA (ITALIA)
Tel +39 051 969870 Fax +39 051 969725 www.dbtechnologies.com info@dbtechnologies-aeb.com



Thank you for choosing a dBTechnologies Product!

The FMX 15 is a versatile coaxial active stage monitor. It is equipped with one 1" compression driver (1.3" voice coil), and one 15" woofer (2" voice coil). The coverage pattern is 60° (H) x 90° (V), (the horn is rotatable) and the mechanical design allows also the vertical usage (36 mm diameter pole mount hole). A powerful DSP can adapt the live or playback performances to different usage scenarios. The balanced audio input allows the usage of a microphone or a line source (a mixer or instrument).

Check the site www.dbtechnologies.com for the complete user manual!

1) Unpacking

The box contains:

N°1 FMX 15

N°1 Mains cable (VDE)

This quick start and warranty documentation

2) Easy installation

FMX 15 is equipped with:

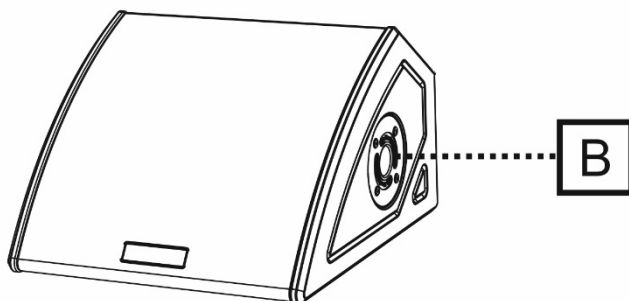
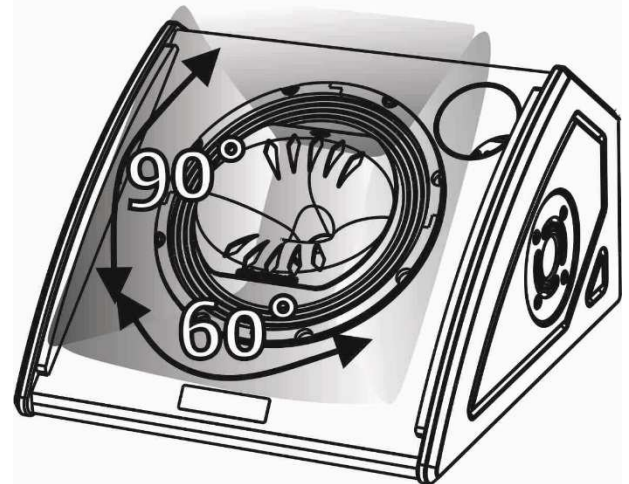
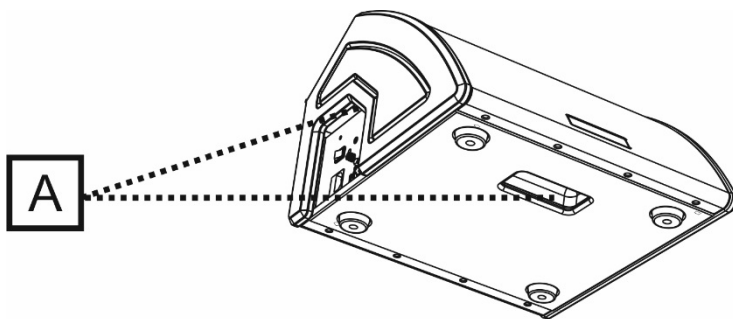

The acoustical design allows to face different environments. The dispersion pattern is shown in the upper picture.

As described, the related pattern data are:

- a) vertical coverage: 90°
- b) horizontal coverage: 60°

The horn is rotatable. See other information in the complete user manual.

A – Integrated/inner handles

B – 36 mm pole mount

Those mechanical particulars were thought for an easy use and for different configuration needs.

In case of vertical usage, please see also the EQ configuration in “Connections and controls” section.

3) Connections and controls

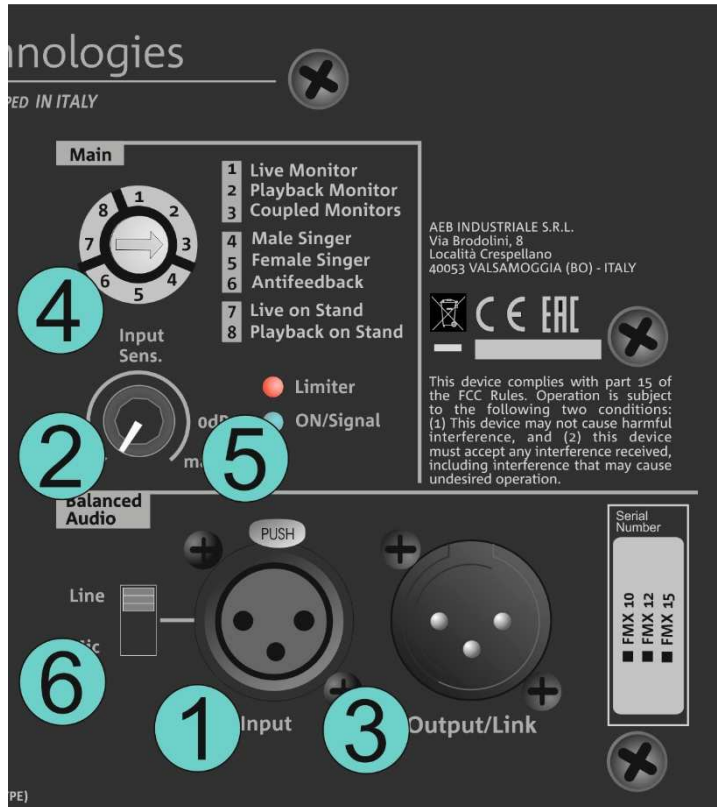

a) Connect the audio input (1). In case of a microphone, plug it and select “Mic” in the Input sensitivity switch (6). In the other cases check that the switch is set on “Line”. Adjust the level of Sensitivity (2).

b) If you need to link FMX 15 to another one, please use a cable with XLR connectors (not supplied). Connect the Link output (3) of the first, to the balanced Input (1) of the second one. In the second loudspeaker, please check that the switch (6) is set on “Line” position and that Sensitivity (3) is set to the correct value.

c) Set properly the DSP preset using the Main EQ Rotary (4). You can choose between:

1. **Live Monitor**, for a single monitor use on the stage in live performance
2. **Playback Monitor**, for a single monitor use on the stage in playback performance
3. **Coupled Monitors**, for a double monitor live usage
4. **Male Singer**, to enhance male vocal performance
5. **Female Singer**, to enhance female vocal performance
6. **Antifeedback**, to avoid Larsen effect in live performances
7. **Live on Stand**, for an optimization of the monitor in vertical usage and live performance
8. **Playback on Stand** for an optimization of the monitor in vertical usage and playback performance

d) Plug properly the mains VDE input cable (supplied) in the related input (7). Then switch the POWER switch (8) to “ON” position. Increase gradually the volume of the audio source to the desired level.

Check the complete user manual on www.dbtechnologies.com for further information about the system and available accessories.

Scarica il manuale completo da www.dbtechnologies.com per ogni ulteriore informazione sul sistema e sugli accessori disponibili.

Für weitere Informationen und verfügbares Zubehör lesen sie bitte die vollständige Bedienungsanleitung unter www.dbtechnologies.com.

Vérifiez le manuel de l'utilisateur complet sur www.dbtechnologies.com pour des informations complémentaires du système et des accessoires disponibles.

Compruebe el manual de usuario completo sobre www.dbtechnologies.com para la información adicional sobre el sistema y accesorios disponibles.

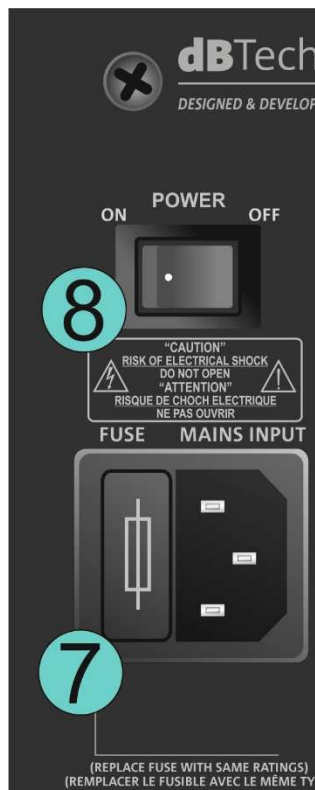

All the connections and controls are in the amplifier panel, on the side of the monitor:

- 1) Balanced Audio Input
- 2) Input sensitivity
- 3) Output/Link
- 4) Main EQ Rotary
- 5) Status LEDs
- 6) Line/Mic switch
- 7) VDE input with fuse
- 8) Power ON/OFF switch

Technical Data

Speaker Type: Coaxial Active Stage Monitor
Usable Bandwidth [-10 dB]: 46 – 19000 Hz
Frequency Response [-6 dB]: 50 – 15500 Hz
Max SPL (1 m): 128 dB
HF compression driver: 1 " Exit
HF voice coil: 1.3"
LF: 15"
LF Voice Coil: 2"
Crossover frequency: 1740 Hz (24 dB/oct)
Horizontal dispersion: 60° (rotatable horn)
Vertical dispersion: 90° (rotatable horn)

Amplifier

PSU Technology: SMPS
Amp Class: Class-D
RMS Power: 600 W

Operating voltage (factory internal setup):

220-240V~ (50-60Hz) or
100-120V~ (50-60 Hz)

Processor and user interface

Controller: 28/56 bit DSP
AD/DA Conversion: 24 bit - 48 kHz
Limiter: Peak, thermal, RMS
Controls: DSP programs rotary encoder, Line/Mic switch, Input Sensitivity level

Input / Output

Mains connections: VDE
Signal Inputs: 1 x balanced XLR connector
Signal Out/Link: 1 x balanced XLR connector

Mechanics

Housing: Wooden Box
Grille: Full metal grille
Pole Mount Hole: Yes, 36 mm
Width: 500 mm (19.68 in)
Height: 340 mm (13.38 in)
Depth: 500 mm (19.68 in)
Weight: 16.9 kg (37.2 lbs)



Scan with your QR Reader
App to download the
complete User Manual

EMI CLASSIFICATION

According to the standards EN 55032 and EN 55035 this equipment is designed and suitable to operate in class B electromagnetic environments.

FCC CLASS B STATEMENT

This device complies with part 15 of the FCC Rules. Operation is subject to the following two conditions: (1) this device may not cause harmful interference, and (2) this device must accept any interference received, including interference that may cause undesired operation.

Changes or modifications not expressly approved by the party responsible for compliance could void the user's authority to operate the equipment.

NOTE: This equipment has been tested and found to comply with the limits for a Class B digital device, pursuant to Part 15 of the FCC Rules. These limits are designed to provide reasonable protection against harmful interference in a residential installation. This equipment generates, uses and can radiate radio frequency energy and, if not installed and used in accordance with the instructions, may cause harmful interference to radio communications. However, there is no guarantee that interference will not occur in a particular installation. If this equipment does cause harmful interference to radio or television reception, which can be determined by turning the equipment off and on, the user is encouraged to try to correct the interference by one or more of the following measures:

1. Reorient or relocate the receiving antenna.
2. Increase the separation between the equipment and receiver.
3. Connect the equipment into an outlet on a circuit different from that to which the receiver is connected.
4. Consult the dealer or an experienced radio/TV technician for help.

WARNING: Make sure that the loudspeaker is securely installed in a stable position to avoid any injuries or damages to persons or properties. For safety reasons do not place one loudspeaker on top of another without proper fastening systems. Before hanging the loudspeaker check all the components for damages, deformations, missing or damaged parts that may compromise safety during installation. If you use the loudspeakers outdoor avoid spots exposed to bad weather conditions.

Contact dB Technologies for accessories to be used with speakers. dBTechnologies will not accept any responsibility for damages caused by inappropriate accessories or additional devices.

Features, specification and appearance of products are subject to change without notice. dBTechnologies reserves the right to make changes or improvements in design or manufacturing without assuming any obligation to change or improve products previously manufactured.

POWER SUPPLY SPECIFICATIONS (POWER ABSORPTION)

Draw at 1/3 of full power in maximum use conditions (**): 1.2 A (220-240V~) - 2 A (100-120V~)

** INSTALLER NOTES: The values refer to 1/3 of full power, in heavy operating conditions (music program with frequent clipping or activation of the limiter). We recommend sizing according to these values in case of professional installations and tours.

Download the complete user manual from the site:

www.dbtechnologies.com/EN/Downloads.aspx