

DVX **P** SERIES

PROFESSIONAL PASSIVE SPEAKER

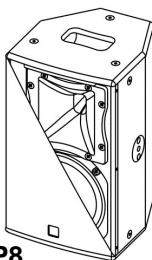

DVX P8

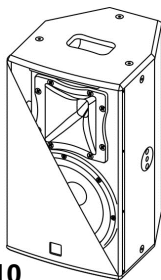

DVX P10

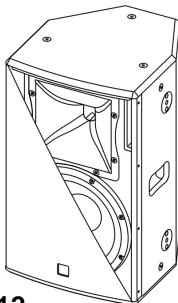

DVX P12

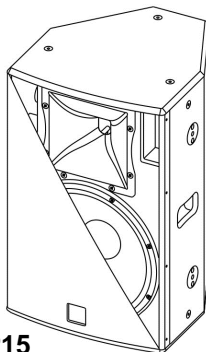

DVX P15

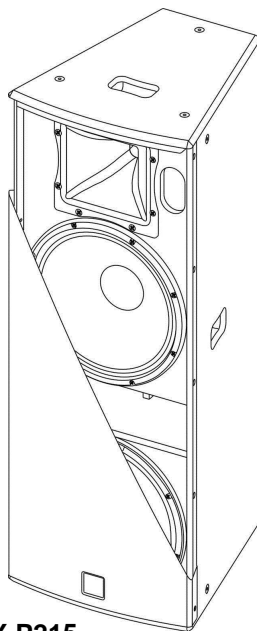

DVX P215



MANUALE D'USO - Sezione 1

USER MANUAL - Section 1

BEDIENUNGSANLEITUNG - Abschnitt 1

CARACTERISTIQUES TECHNIQUES - Section 1



Le avvertenze nel presente manuale devono essere osservate congiuntamente al "Manuale d'uso - Sezione2".

The warnings in this manual must be observed together with the "User Manual - Section 2".

Die Warnungen in diesem Handbuch müssen in Verbindung mit der "Bedienungsanleitung - Abschnitt 2" beobachtet werden.

Les avertissements dans ce manuel doivent être respectés en collaboration avec le "Manuel - Section 2".

DESCRIZIONE

“DVX P” è una serie di diffusori passivi a due vie in legno multistrato, studiati per la sonorizzazione di ambienti medio grandi.

Questi diffusori sono provvisti di un filtro passivo con pendenza 12dB/oct per la sezione bassi, 18dB/oct per la sezione alti ed una protezione termica autoripristinante sul driver per evitare danni causati da sovraccarichi prolungati.

DVX P8

Il diffusore passivo DVX P8 è equipaggiato con un woofer 8" (voice coil 2") ed un compression driver al neodimio da 1" (voice coil 1.5") montato su una tromba ruotabile in plastica con dispersione 90°x70°.

Esso viene fornito con la tromba con apertura di 90° in senso orizzontale e di 70° in senso verticale.

Il diffusore è provvisto di 1 maniglia superiore ad incasso, di 12 punti M8 d'aggancio e di 2 punti flypins posti sui fianchi del diffusore, che facilitano l'installazione e il trasporto.

Il diffusore è stato progettato anche per l'utilizzo come stage monitor (con angolazione 45°); ruotando la tromba è possibile mantenere lo stesso angolo di copertura audio delle alte frequenze.

Nella parte inferiore del box è presente un supporto piantana standard (D36mm) in alluminio.

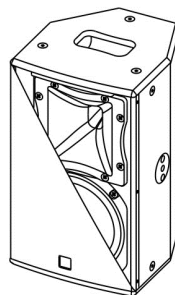

DVX P10

Il diffusore passivo DVX P10 è equipaggiato con un woofer 10" (voice coil 2") ed un compression driver al neodimio da 1" (voice coil 1.5") montato su una tromba ruotabile in plastica con dispersione 90°x70°.

Esso viene fornito con la tromba con apertura di 90° in senso orizzontale e di 70° in senso verticale.

Il diffusore è provvisto di 1 maniglia superiore ad incasso, di 12 punti M8 d'aggancio e di 2 punti flypins posti sui fianchi del diffusore, che facilitano l'installazione e il trasporto.

Il diffusore è stato progettato anche per l'utilizzo come stage monitor (con angolazione 45°); ruotando la tromba è possibile mantenere lo stesso angolo di copertura audio delle alte frequenze.

Nella parte inferiore del box è presente un supporto piantana standard (D36mm) in alluminio.

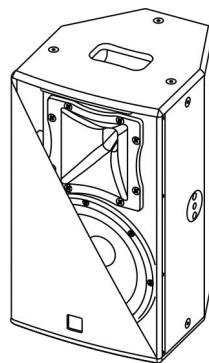

DVX P12

Il diffusore passivo DVX P12 è equipaggiato con un woofer 12" (voice coil 3") ed un compression driver al neodimio da 1,4" (voice coil 2.5") montato su una tromba di alluminio con dispersione 90°x40°.

Esso viene fornito con la tromba con apertura di 90° in senso orizzontale e di 40° in senso verticale.

Il diffusore è provvisto di 2 maniglie laterali ad incasso, di 12 punti M10 e di 4 punti flypins posti sui fianchi e sul retro del diffusore, che facilitano l'installazione e il trasporto.

Il diffusore è stato progettato anche per l'utilizzo in appoggio come monitor (con angolazione 45°); ruotando la tromba è possibile mantenere lo stesso angolo di copertura anche con utilizzo a monitor.

Nella parte inferiore del box è presente un supporto piantana standard (D36mm) in alluminio.

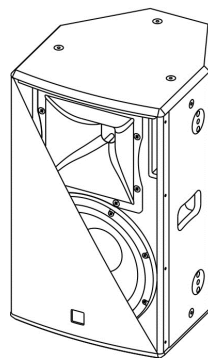

DVX P15

Il diffusore passivo DVX P15 è equipaggiato con un woofer 15" (voice coil 3") ed un compression driver al neodimio da 1,4" (voice coil 2.5") montato su una tromba di alluminio con dispersione 90°x40°.

Esso viene fornito con la tromba con apertura di 90° in senso orizzontale e di 40° in senso verticale.

Il diffusore è provvisto di 2 maniglie laterali ad incasso, di 12 punti M10 e i 4 punti flypins posti sui fianchi e sul retro del diffusore che facilitano l'installazione e il trasporto.

Il diffusore è stato progettato anche per l'utilizzo in appoggio come monitor (con angolazione 45°); ruotando la tromba è possibile mantenere lo stesso angolo di copertura anche con utilizzo a monitor.

Nella parte inferiore del box è presente un supporto piantana standard (D36mm) in alluminio.

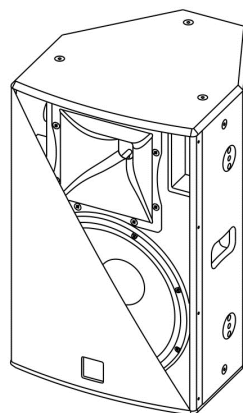

DVX P215

Il diffusore passivo DVX P215 è equipaggiato con due woofer 15" (voice coil 3") ed un compression driver al neodimio da 1,4" (voice coil 2.5") montato su una tromba di alluminio con dispersione 60°x40°.

Esso viene fornito con la tromba con apertura di 60° in senso orizzontale e di 40° in senso verticale e con il collegamento interno settato per un funzionamento Full range.

Rimuovendo il pannello posteriore è possibile settare il diffusore in funzionamento Bi-Amp. (fare riferimento a pag.41 per tale modifica).

Il diffusore è provvisto di 2 maniglie laterali ad incasso, di 1 maniglia sul lato superiore e di 1 maniglia sul lato inferiore, di 11 punti M10 posti sui fianchi e sul retro del diffusore che facilitano l'installazione e il trasporto.

Nella parte inferiore del box è presente un piede regolabile per variane l'inclinazione ed aggiustare il tilt per un corretto puntamento.

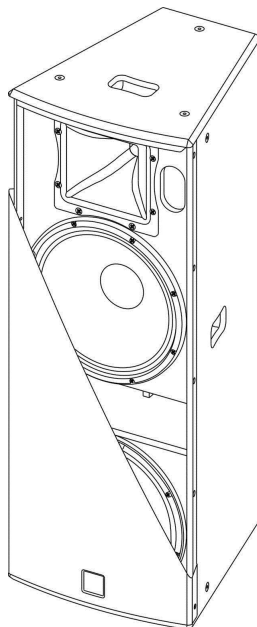
**COLLEGAMENTI****ATTENZIONE**

Per evitare il rischio di shock elettrici, non collegare il diffusore con l'amplificatore acceso. Prima di far funzionare il diffusore verificare attentamente la correttezza dei collegamenti per evitare cortocircuiti o errate connessioni

Nel pannello connessioni situato sul lato posteriore del diffusore sono presenti due connettori Speakon a 4 poli: una presa consente l'ingresso del segnale audio, mentre la seconda presa può essere utilizzata come uscita per il collegamento in parallelo di un altro diffusore.

I collegamenti sui connettori sono:

- 1+ per il segnale positivo
- 1- per il segnale negativo (massa)
- 2+ non connesso
- 2- non connesso

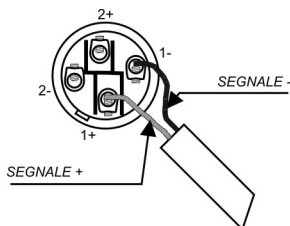

per:
DVX P8
DVX P10
DVX P12
DVX P15

DVX P215 (FULL RANGE MODE)

Nel caso in cui si intenda rilanciare il segnale amplificato, da un diffusore ad un altro, prestare particolare attenzione all'impedenza nominale risultante dal collegamento, che non dovrà essere mai inferiore all'impedenza minima dell'amplificatore di potenza. Questo per evitare surriscaldamenti anomali o peggio danneggiamenti all'amplificatore.

I diffusori della serie "DVX P" hanno una impedenza nominale d'ingresso di 8 ohm, e a questa bisognerà fare riferimento per le connessioni.

ROTAZIONE TROMBA

Il diffusore permette di modificare l'angolo di copertura acustica, tramite la rotazione della tromba.

Se si desidera modificare la posizione della tromba è necessario:

- svitare le viti di fissaggio della rete (otto viti - quattro per lato)
- rimuovere la rete di protezione anteriore esercitando una leggera pressione su un lato e sollevarla dall'opposto incasso
- svitare le otto viti di fissaggio della tromba
- ruotare la tromba nella posizione desiderata (non estrarre mai il blocco tromba dal diffusore)
- avvitare di nuovo le viti di fissaggio della tromba
- inserire nuovamente la rete negli appositi incassi laterali e riavvitare le viti della rete.

INSTALLAZIONE DEL DIFFUSORE



ATTENZIONE

Installare il diffusore in modo stabile e sicuro, così da evitare qualsiasi condizione di pericolo per l'incolumità di persone e strutture.

Per evitare condizioni di pericolo non sovrapporre fra loro più diffusori senza adeguati sistemi di ancoraggio. Prima di sospendere il diffusore controllare tutti i componenti da utilizzare, che non devono presentare danni, deformazioni, parti mancanti o danneggiate che possono ridurre la sicurezza dell'installazione.

Nell'utilizzo all'aperto evitare luoghi esposti alle intemperie.

Il diffusore viene fornito dalla ditta costruttrice predisposto per l'utilizzo :

- in appoggio
- a pavimento (come monitor)
- su supporto piantana
- appeso con golfari
- con apposite staffe fornite dalla ditta.

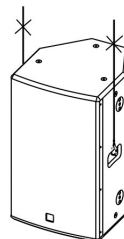
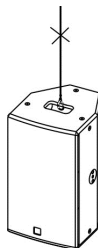

ATTENZIONE

Non utilizzare mai le maniglie per appendere il diffusore!

Utilizzare le maniglie esclusivamente per la movimentazione del singolo diffusore.



ATTENZIONE

Per appendere il diffusore utilizzare solo una vite per ogni punto di appendibilità

I punti di appendibilità sono di M8 per i diffusori DVX P8 e DVX P10 e sono di M10 per i diffusori DVX P12 e DVX P15.

Non togliere entrambe le viti di fissaggio.

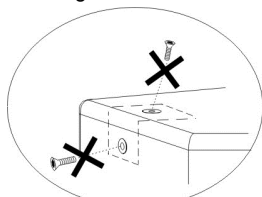

NO!

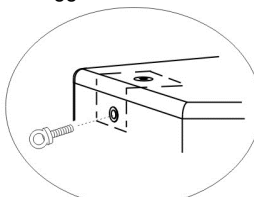

SI!

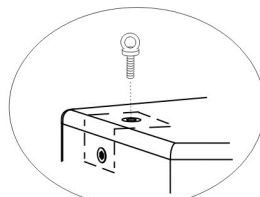

SI!

DATI TECNICI

	DVX P8	DVX P10
Sistema	Passivo – 2 vie	Passivo – 2 vie
Potenza RMS	300W	300W
Potenza Peak	600W	600W
Risposta in Frequenza (-10dB)	75Hz-20KHz	70Hz-20KHz
(-6dB)	100Hz-20KHz	90Hz-20KHz
Crossover	1800Hz	1800Hz
Sensibilità 1W@1m	94dB	96dB
Pressione sonora (SPL)	125dBmax	127dBmax
Componenti	1 Woofer 8" 2" Coil 1x1" Compression Diver Neodimio 1.5" voice coil	1 Woofer 10" 2" Coil 1x1" Compression Diver Neodimio 1.5" voice coil
Impedenza ingresso	8ohm	8ohm
Filtri	18dB/oct PASSA ALTO 12dB/oct PASSA BASSO	18dB/oct PASSA ALTO 12dB/oct PASSA BASSO
Dispersione	90°x70° (rotabile)	90°x70° (rotabile)
Connettori audio	2 x SPEAKON In parallelo	2 x SPEAKON In parallelo
Dimensioni (LxHxP)	250x425x260mm 9.8x16.7x10.2inch.	290x510x310mm 11.4x20.1x12.2 inch.
Peso	9.8Kg 21.6lbs	12.5Kg 27.6lbs
Meccanica		
Materiale box	Multistrato	Multistrato
Colore	Nero	Nero
Maniglie	1 x ad incasso (parte alta)	1 x ad incasso (parte alta)
Inseri per appendibilità	12 x M8 2 x flypin	12 x M8 2 x flypin
Supporto piantana	D36mm (alluminio)	D36mm (alluminio)
Rete frontale	Lamiera forata 1.2mm + foam	Lamiera forata 1.2mm + foam

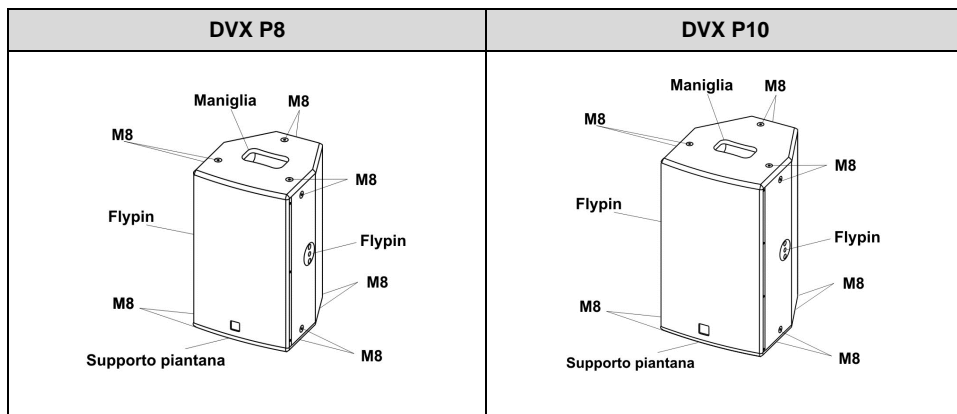

DATI TECNICI

	DVX P12	DVX P15
Sistema	Passivo – 2 vie	Passivo – 2 vie
Potenza RMS	500W	500W
Potenza Peak	1000W	1000W
Risposta in Frequenza (-10dB)	60Hz-20KHz	60Hz-20KHz
(-6dB)	90Hz-20KHz	70Hz-20KHz
Crossover	1400Hz	1400Hz
Sensibilità 1W@1m	100dB	100dB
Pressione sonora (SPL)	133dBmax	133dBmax
Componenti	1 Woofer 12" 3" Coil 1x1.4" Compression Diver Neodimio 2.5" voice coil Dome al Titanio	1 Woofer 15" 3" Coil 1x1.4" Compression Diver Neodimio 2.5" voice coil Dome al Titanio
Impedenza ingresso	8ohm	8ohm
Filtri	18dB/oct PASSA ALTO 12dB/oct PASSA BASSO	18dB/oct PASSA ALTO 12dB/oct PASSA BASSO
Dispersione	90°x40° (rotabile)	90°x40° (rotabile)
Connettori audio	2 x SPEAKON In parallelo	2 x SPEAKON In parallelo
Dimensioni (LxHxP)	370x625x395mm 14.6x24.6x15.5inch.	430x690x450mm 16.9x27.2x17.7inch.
Peso	23.2Kg 51.1lbs	26.1Kg 57.5lbs
Meccanica		
Materiale box	Multistrato	Multistrato
Colore	Nero	Nero
Maniglie	2 x ad incasso (1 x lato)	2 x ad incasso (1 x lato)
Inseri per appendibilità	12 x M10 4 x flypin	12 x M10 4 x flypin
Supporto piantana	D36mm (alluminio)	D36mm (alluminio)
Rete frontale	Lamiera forata 1.5mm + foam	Lamiera forata 1.5mm + foam

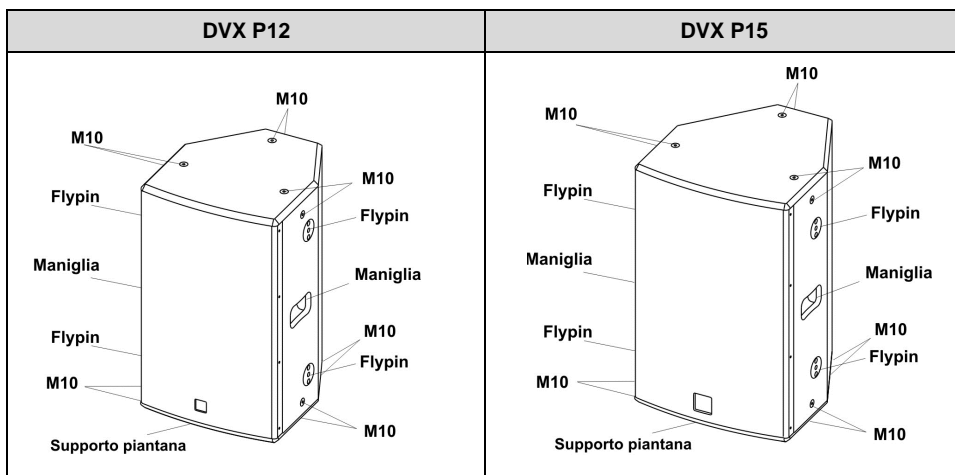

DATI TECNICI

DVX P215	
Sistema	Passivo – 2 vie
Potenza RMS (Full Range) (Bi Amp)	1000W 900W (Woofer) + 90W (Driver)
Potenza Peak	2000W
Risposta in Frequenza (-10dB Full range) (-6dB Full range) (Bi Amp)	60Hz-20KHz 66Hz-20KHz 60Hz-2KHz (Woofer) 700Hz-20KHz (Driver)
Crossover	1300Hz
Sensibilità 1W@1m	103dB
Pressione sonora (SPL)	136dB
Componenti	2x15" Woofer VC 3" 1x1.4" Comp. Driver Neo VC 2.5" Dome al Titanio
Impedenza ingresso (Full range) (Bi Amp)	4ohm 4ohm (Woofer) + 8ohm (Driver)
Filtri	18dB/oct PASSA ALTO 12dB/oct PASSA BASSO
Dispersione	60°x40° (rotabile)
Connettori audio	2 x SPEAKON In parallelo
Dimensioni (LxHxP)	446x500x1202mm 17.6x19.7x47.3inch.
Peso	47Kg 103.6lbs
Meccanica	
Materiale box	Multistrato
Colore	Nero
Maniglie	4 x ad incasso
Inserti per appendibilità	11 x M10
Appoggio	Piede regolabile
Rete frontale	Lamiera forata 1.5mm + foam

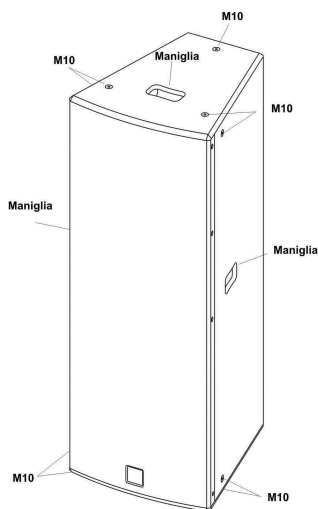
DVX P215

Vista frontale

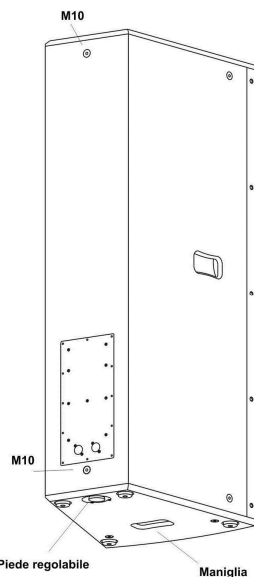

Vista retro

DESCRIPTION

"DVX P" is a series two-way passive loudspeakers with of plywood box designed for medium to large sized rooms.

The loudspeakers of the DVX P series feature passive crossover filters with a slope of 12dB/oct for the low-pass part, 18dB/oct for the high-pass and a self-resetting thermal protection circuit on the driver to prevent damages due to protracted overloading.

DVX P8

The passive speaker DVX P8 is equipped with a woofer 8" (voice coil 2") and a compression driver 1" (voice coil 1.5") on a 90°x70° rotatable plastic CD- horn.

The speaker's horizontal directivity is 90° and vertical directivity is 70° by default factory setting.

The speaker has a top handle housing, the 12 M8 threads and the 2 flypins located on the sides and the back of the speaker are enabling easy transport and installation.

The speaker has been designed to be used also as stage monitor (45° angle). By rotating the horn you can maintain the same coverage angle also when the speaker is used as monitor.

In the bottom of the box there is a standard pole mount cup (D36mm) made of aluminium.

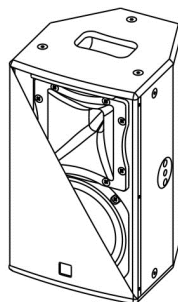

DVX P10

The passive speaker DVX P10 is equipped with a woofer 10" (voice coil 2") and a compression driver 1" (voice coil 1,5") on a 90°x70° rotatable plastic CD- horn.

The speaker's horizontal directivity is 90° and vertical directivity is 70° by default factory setting.

The speaker has a top handle housing, the 12 M8 threads and the 2 flypins located on the sides and the back of the speaker are enabling easy transport and installation.

The speaker has been designed to be used also as stage monitor (45° angle). By rotating the horn you can maintain the same coverage angle also when the speaker is used as monitor.

In the bottom of the box there is a standard pole mount cup (D36mm) made of aluminium.

In the bottom of the box there is a standard pole mount cup (D36mm) made of aluminium.

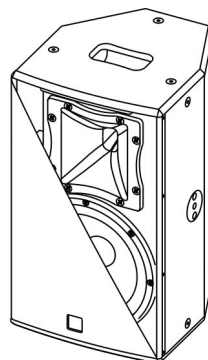

DVX P12

The passive speaker DVX P12 is equipped with a woofer 12" (voice coil 3") and a compression driver 1.4" (voice coil 2.5") installed on a 90°x40° rotatable aluminium CD- horn.

The speaker's horizontal directivity is 90° and vertical directivity is 40° by default factory setting.

The speaker has the 2 handles housing on the sides, the 12 M10 threads and the 4 flypins located on the sides and the back of the speaker are enabling easy transport and installation.

The speaker has been designed to be used also as stage monitor (45° angle). By rotating the horn you can maintain the same coverage angle also when the speaker is used as monitor.

In the bottom of the box there is a standard pole mount cup (D36mm) made of aluminium.

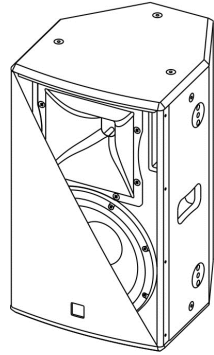
**DVX P15**

The passive speaker DVX P15 is equipped with a woofer 15" (voice coil 3") and a compression driver 1.4" (voice coil 2.5") installed on a 90°x40° rotatable aluminium CD- horn.

The speaker's horizontal directivity is 90° and vertical directivity is 40° by default factory setting.

The speaker has the 2 handles housing on the sides, the 12 M10 threads and the 4 flypins located on the sides and the back of the speaker are enabling easy transport and installation.

The speaker has been designed to be used also as stage monitor (45° angle). By rotating the horn you can maintain the same coverage angle also when the speaker is used as monitor.

In the bottom of the box there is a standard pole mount cup (D36mm) made of aluminium.

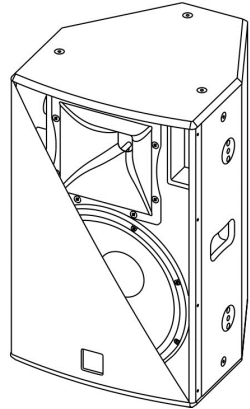

DVX P215

The passive speaker DVX P215 is equipped with two woofers 15" (voice coil 3") and a compression driver 1.4" (voice coil 2.5") installed on a 60°x40° rotatable aluminium CD- horn.

The speaker's horizontal directivity is 60° and vertical directivity is 40° and FULL RANGE setting by default factory setting.

Removing the rear panel it is possible to set the Bi-Amp mode. (refer to pag.41 for the modify).

The speaker has the 4 handles housing, one per sides, the 11 M10 threads located on the sides and the back of the speaker are enabling easy transport and installation.

A adjustable foot is present in the bottom side of the box, to adjust the tilt for a good working.

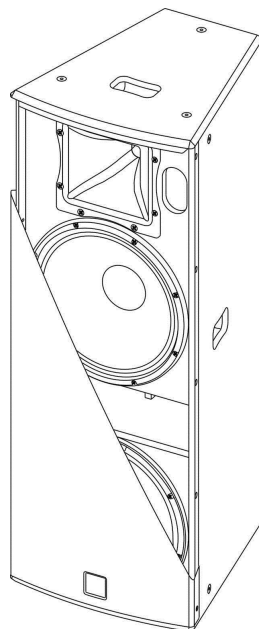

CONNECTIONS

WARNING



To avoid electric shocks, ensure that your amplifier is switched off when you plug in the loudspeaker. Before turning on the loudspeaker, be sure that the connections are correct to avoid short circuits or wrong connections.

The connection panel at the back of the loudspeaker features two 4 pole Speakon connectors: the first socket is the sound signal input socket and the second socket may function as an output terminal for the connection with another loudspeaker.

The connections are:

- 1+ for the positive signal
- 1- for the negative signal (ground)
- 2+ not connected
- 2- not connected

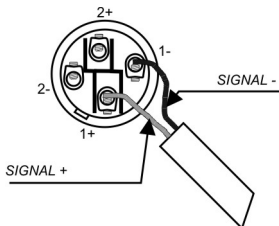

for:
DVX P8
DVX P10
DVX P12
DVX P15
DVX P215 (FULL RANGE MODE)

If you wish to send the amplified signal from one loudspeaker to the other, be sure that the nominal impedance resulting from the connection is never lower than the minimum impedance of the power amplifier. This is done to prevent overheating or, worse, damages to the amplifier.

The loudspeakers of the "DVX P" series have a nominal input impedance of 8 ohms and this must be taken into account when making the connections.

ROTATING HORN

When used horizontally, the loudspeakers of the DVX P series allow to maintain the same coverage angle through a rotating horn.

If you wish to change the coverage angle:

- undo the fixing screws of the grille
- remove the front protective grille by slightly pressing on one side and taking the grille off the special slots
- undo the eight fixing screws of the horn
- rotate the horn in the desired position (the horn should never be removed from the loudspeaker)
- tighten the fixing screws of the horn
- put the grille back in the special side slots and tighten the screws of the grille.

LOUDSPEAKER INSTALLATION



WARNING

Make sure that the loudspeaker is securely installed in a stable position to avoid any injuries or damages to persons or property.

For safety reasons do not place one loudspeaker on top of another without proper fastening systems. Before hanging the loudspeaker check all the components for damages, deformations, missing or damaged parts that may compromise safety during installation.

If you use the loudspeakers outdoors avoid places that are exposed to bad weather.

The loudspeaker has the following mounting options:

- bookshelf
- floor (monitor)
- standmount
- suspended with support rails or brackets supplied by the manufacturer



WARNING

Never use the handles to hang the speaker!
Use the handles only to move the single speaker!

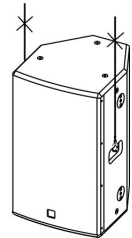
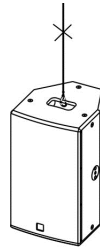

WARNING

To hang the loudspeaker use only one screw for each hanging point
The hanging points are M8 for DVX P8 and DVX P10, or M10 for DVX P12 and DVX P15

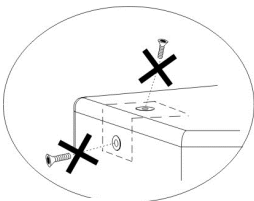

NO!

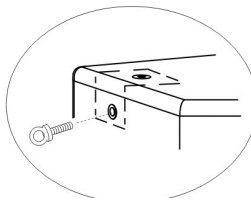

YES!

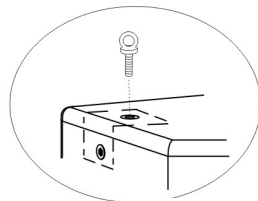

YES!

TECHNICAL SPECIFICATION

	DVX P8	DVX P10
System	Passive – 2 ways	Passive – 2 ways
RMS Power	300W	300W
Peak Power	600W	600W
Frequency Responce (-10dB)	75Hz-20KHz	70Hz-20KHz
(-6dB)	100Hz-20KHz	90Hz-20KHz
Crossover	1800Hz	1800Hz
Sensitivity 1W@1m	94dB	96dB
Sound pressure (SPL)	125dBmax	127dBmax
Components	1 Woofer 8" 2" Coil 1x1" Compression Diver Neodymium 1.5" voice coil	1 Woofer 10" 2" Coil 1x1" Compression Diver Neodymium 1.5" voice coil
Impedence	8ohm	8ohm
Filter	18dB/oct HIGH PASS 12dB/oct LOW PASS	18dB/oct HIGH PASS 12dB/oct LOW PASS
Dispersion	90°x70° (rotatable)	90°x70° (rotatable)
Audio connector	2 x SPEAKON In parallel	2 x SPEAKON In parallel
Dimension (WxHxD)	250x425x260mm 9.8x16.7x10.2inch.	290x510x310mm 11.4x20.1x12.2 inch.
Weight	9.8Kg 21.6lbs	12.5Kg 27.6lbs
Meccanic		
Box material	Plywood	Plywood
Color	Black	Black
Handle	1 x housing (top side)	1 x housing (top side)
Flying support	12 x M8 2 x flypin	12 x M8 2 x flypin
Pole mount cup	D36mm (alluminium)	D36mm (alluminium)
Front grille	Perforated metal plate 1.2mm + foam	Perforated metal plate 1.2mm + foam

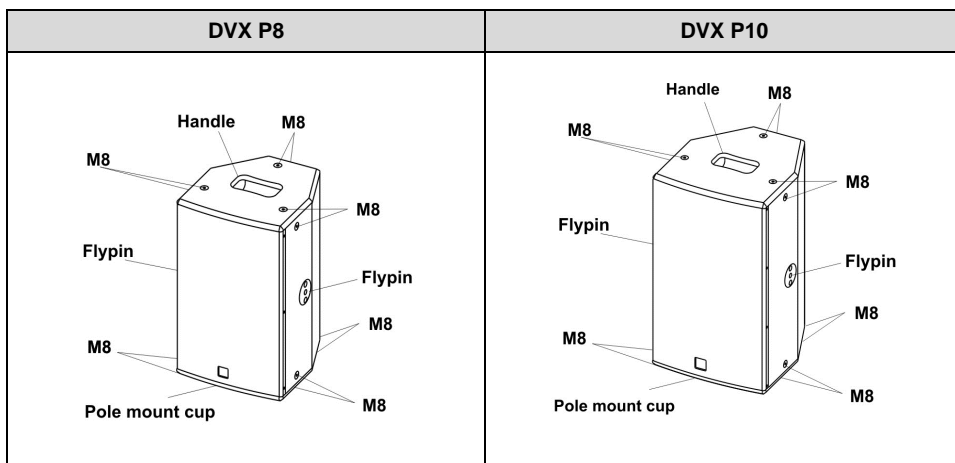

TECHNICAL SPECIFICATION

	DVX P12	DVX P15
System	Passive – 2 ways	Passivo – 2 ways
RMS Power	500W	500W
Peak Power	1000W	1000W
Frequency Responce (-10dB)	60Hz-20KHz	60Hz-20KHz
(-6dB)	90Hz-20KHz	70Hz-20KHz
Crossover	1400Hz	1400Hz
Sensitivity 1W@1m	100dB	100dB
Sound pressure (SPL)	133dBmax	133dBmax
Components	1 Woofer 12" 3" Coil 1x1.4" Compression Diver Neodymium 2.5" voice coil Dome Titanium	1 Woofer 15" 3" Coil 1x1.4" Compression Diver Neodymium 2.5" voice coil Dome Titanium
Impedence	8ohm	8ohm
Filter	18dB/oct HIGH PASS 12dB/oct LOW PASS	18dB/oct HIGH PASS 12dB/oct LOW PASS
Dispersion	90°x40° (rotatable)	90°x40° (rotatable)
Audio connector	2 x SPEAKON In parallel	2 x SPEAKON In parallel
Dimension (WxHxD)	370x625x395mm 14.6x24.6x15.5inch.	430x690x450mm 16.9x27.2x17.7inch.
Weight	23.2Kg 51.1lbs	26.1Kg 57.5lbs
Meccanic		
Box material	Plywood	Plywood
Color	Black	Black
Handle	2 x housing (1 x side)	2 x housing (1 x side)
Flying support	12 x M10 4 x flypin	12 x M10 4 x flypin
Pole mount cup	D36mm (alluminium)	D36mm (alluminium)
Front grille	Perforated metal plate 1.5mm + foam	Perforated metal plate 1.5mm + foam

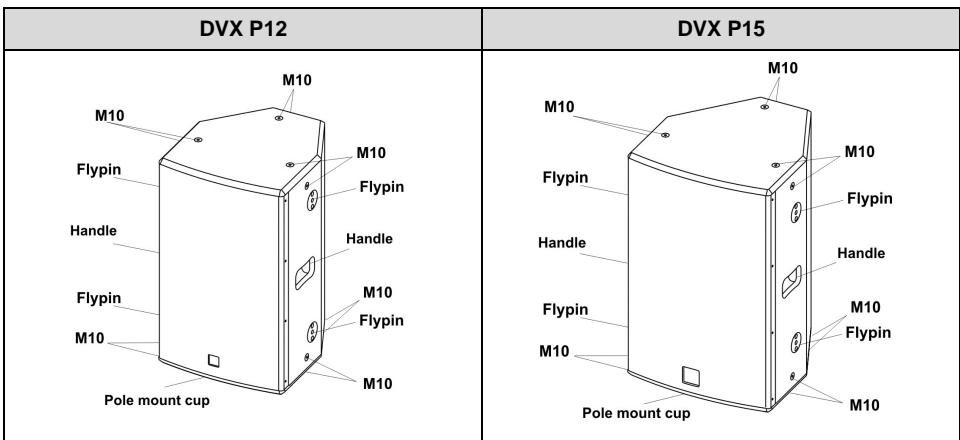

TECHNICAL SPECIFICATION

DVX P215	
System	Passive – 2 way
Potenza RMS (Full Range) (Bi Amp)	1000W 900W (Woofer) + 90W (Driver)
Peak Power	2000W
Frequency Responce (-10dB Full range) (-6dB Full range) (Bi Amp)	60Hz-20KHz 66Hz-20KHz 60Hz-2KHz (Woofer) 700Hz-20KHz (Driver)
Crossover	1300Hz
Sensibility 1W@1m	103dB
Sound pressure (SPL)	136dB
Components	2x15" Woofer VC 3" 1x1.4" Comp. Driver Neo VC 2.5" Dome al Titanio
Impedance (Full range) (Bi Amp)	4ohm 4ohm (Woofer) + 8ohm (Driver)
Filter	18dB/oct HIGH PASS 12dB/oct LOW PASS
Dispersion	60°x40° (rotatable)
Audio connector	2 x SPEAKON In parallel
Dimension (LxHxP)	446x500x1202mm 17.6x19.7x47.3inch.
Weight	47Kg 103.6lbs
Meccanic	
Box material	Plywood
Color	Black
Handle	4 x housing
Flying support	11 x M10
Support	Adjustable foot
Front grille	Perforated metal plate 1.5mm + foam

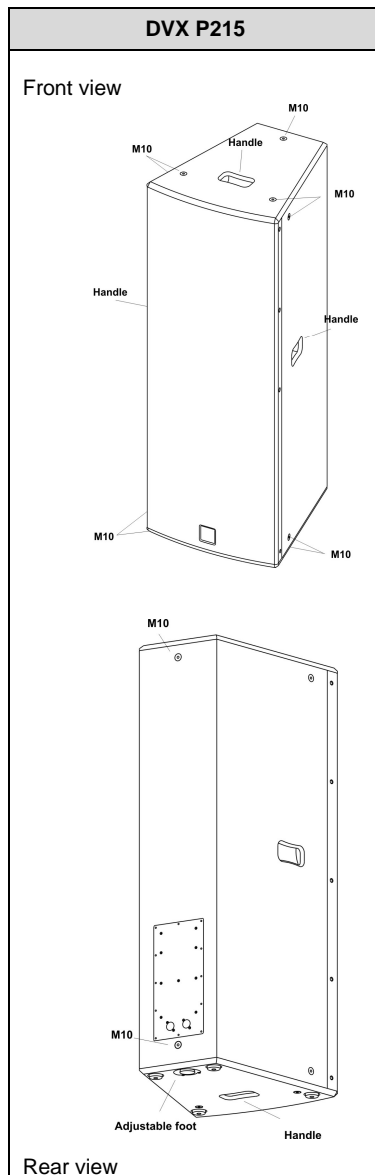

BESCHREIBUNG

“DVX P series” ist eine Reihe von Zweivegepassivlautsprechern aus Holz, die für die Beschallung von mittelgroßen bis großen Räumen hergestellt wurden.

Die Lautsprecher der Serie DVX P sind mit einem passiven Filter mit einer Flankensteilheit von 12dB/oct für Bass, von 18dB/oct für Höhen und mit einem selbstrücksetzenden Wärmeschutz auf dem Driver ausgestattet, um den Langzeitüberlast zu vermeiden.

DVX P8

Der DVX P8 ist Zweivegepassivlautsprechern mit einem 8“ Woofer (Voice coil 2“) und einem 1“ kompressions- Treiber (voice coil 1,5“), der auf einem CD Horn mit eine Abstrahlwinkel von 90°x70° montiert ist.

Der Lautsprecher wird mit horizontal auf 90° ausgerichtetem CD Horn ausgeliefert.

Der Lautsprecher ist mit 1 Griff, die 12 M8- Gewinde und die 2 Befestigungspunkte für Quicklock-Pins an den Seiten des Lautsprechers ermöglichen einfache Installation und Transport.

Der Lautsprecher ist auch für die Verwendung als Monitor ausgelegt (Winkel 45°). Durch Drehen des Hornes kann der gleiche Abstrahlwinkel auch bei Verwendung als Monitor beibehalten werden.

An der Unterseite der Box ist ein Standard- Ständerflansch aus Aluminium vorhanden (D 36mm).

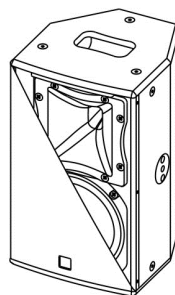

DVX P10

Der DVX P10 ist Zweivegepassivlautsprechern mit einem 10“ Woofer (Voice coil 2“) und einem 1“ kompressions- Treiber (voice coil 1,5“), der auf einem CD Horn mit eine Abstrahlwinkel von 90°x70° montiert ist.

Der Lautsprecher wird mit horizontal auf 90° ausgerichtetem CD Horn ausgeliefert.

Der Lautsprecher ist mit 1 Griff, die 12 M8- Gewinde und die 2 Befestigungspunkte für Quicklock-Pins an den Seiten des Lautsprechers ermöglichen einfache Installation und Transport.

Der Lautsprecher ist auch für die Verwendung als Monitor ausgelegt (Winkel 45°). Durch Drehen des Hornes kann der gleiche Abstrahlwinkel auch bei Verwendung als Monitor beibehalten werden.

An der Unterseite der Box ist ein Standard- Ständerflansch aus Aluminium vorhanden (D 36mm).

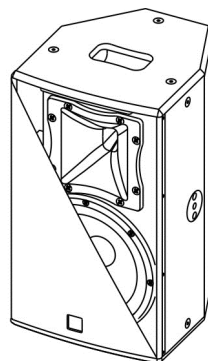

DVX P12

Der DVX P12 ist ein Zweiwegepassivlautsprechern mit einem 12" Woofer (Voice coil 3") und einem 1,4" kompressions-Treiber (voice coil 2.5"), der auf einem Aluminium CD Horn mit eine Abstrahlwinkel von 90°x40° montiert ist.

Der Lautsprecher wird mit horizontal auf 90° ausgerichtetem CD Horn ausgeliefert.

Der Lautsprecher haben 2 Griffe, die 12 M10- Gewinde und die 4 Befestigungspunkte für Quicklock-Pins an den Seiten des Lautsprechers ermöglichen einfache Installation und Transport.

Der Lautsprecher ist auch für die Verwendung als Monitor ausgelegt (Winkel 45°). Durch Drehen des Hornes kann der gleiche Abstrahlwinkel auch bei Verwendung als Monitor beibehalten werden.

An der Unterseite der Box ist ein Standard- Ständerflansch aus Aluminium vorhanden (D 36mm).

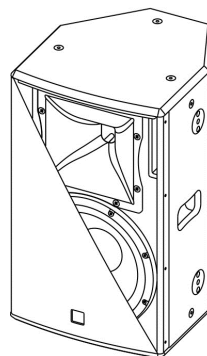

DVX P15

Der DVX P15 ist ein Zweiwegepassivlautsprechern mit einem 15" Woofer (Voice coil 3") und einem 1,4" kompressions-Treiber (voice coil 2.5"), der auf einem Aluminium CD Horn mit eine Abstrahlwinkel von 90°x40° montiert ist.

Der Lautsprecher wird mit horizontal auf 90° ausgerichtetem CD Horn ausgeliefert.

Der Lautsprecher haben 2 Griffe, die 12 M10- Gewinde und die 4 Befestigungspunkte für Quicklock-Pins an den Seiten des Lautsprechers ermöglichen einfache Installation und Transport.

Der Lautsprecher ist auch für die Verwendung als Monitor ausgelegt (Winkel 45°). Durch Drehen des Hornes kann der gleiche Abstrahlwinkel auch bei Verwendung als Monitor beibehalten werden.

An der Unterseite der Box ist ein Standard- Ständerflansch aus Aluminium vorhanden (D 36mm).

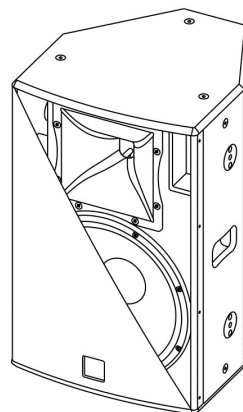

DVX P215

Der DVX P215 ist ein Zweiwegepassivlautsprecher mit zwei 15" Woofer (Voice coil 3") und einem 1,4" Kompressions-Treiber (voice coil 2.5"), der auf einem Aluminium CD Horn mit einer Abstrahlwinkel von 60°x40° montiert ist.

Der Lautsprecher wird mit horizontal auf 90° ausgerichtetem CD Horn ausgeliefert und mit dem internen Anschluss-Set zur Full Range funktionieren.

Entfernen Sie die Rückwand können Sie den Diffusor Betrieb Bi-Amp eingestellt. (Siehe Seite 41).

Der Lautsprecher haben 4 Griffe, die 11 M10 an den Seiten des Lautsprechers ermöglichen einfache Installation und Transport.

Im unteren Teil der Box gibt es einen einstellbaren Fuß, um die Neigung zu variieren und stellen Sie die Neigung für einen einwandfreien Betrieb

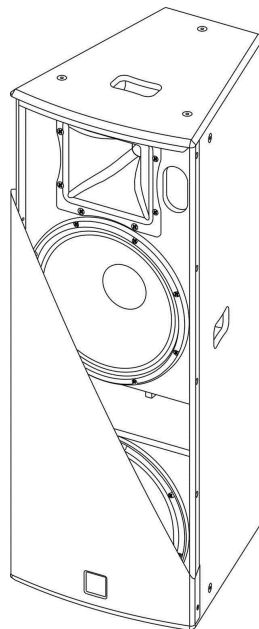
**ANCHLÜSSE****ACHTUNG**

Um das Risiko von Stromschlägen zu vermeiden, soll man den Lautsprecher nie an den angeschalteten Verstärker anschließen. Vor der Inbetriebnahme des Lautsprechers sich vergewissern, dass alle Anschlüsse korrekt sind, um Kurzschlüsse oder fehlerhafte Schaltungen zu vermeiden.

Auf der Schalttafel auf dem hinteren Teil des Lautsprechers befinden sich zwei vierpolige Speakon Verbinder: eine Steckdose ermöglicht den Audio-Eingang und die zweite Steckdose kann als Ausgang für den parallelen Anschluss an einen anderen Lautsprecher verwendet werden.

Die Anschlüsse auf den Verbindern sind folgende :

- 1+ für das positive Signal
- 1- für das negative Signal (Masse)
- 2+ nicht angeschlossen
- 2- nicht angeschlossen

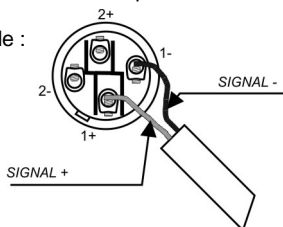

für:
DVX P8
DVX P10
DVX P12
DVX P15
DVX P215 (FULL RANGE MODE)

Wenn man das verstärkte Signal von einem Lautsprecher zu einem anderen Lautsprecher weitersenden möchte, soll man auf die Nennimpedanz des Anschlusses sorgfältig achten, die nie niedriger als die Mindestimpedanz des Verstärkers sein soll. So kann man anomale Überhitzungen oder noch schlimmer Beschädigungen des Lautsprechers vermeiden.

Die Lautsprecher der Serie "DVX P" haben eine Eingangsnennimpedanz von 8 Ohm, und auf solche Impedanz soll man für die Anschlüsse achten.

DREHUNG DES HORNES

Das Hochtonhorn der DVX P Lautsprecherreihe ist drehbar, so dass man bei vertikaler und horizontaler Anwendung, immer das gewünscht Abstrahlverhalten bekommt.

Wenn man den Schallabstrahlungswinkel des Hornes ändern möchte, soll man:

- die Befestigungsschrauben des Gitters herausdrehen
- das vordere Schutzgitter entfernen, indem man einen leichten Druck auf einer Seite ausübt und indem man es von ihren Vertiefungen aufhebt
- die acht Befestigungsschrauben des Hornes herausdrehen
- das Horn in die gewünschte Richtung drehen (den Satz des Hornes nie aus dem Lautsprecher herausnehmen)
- die Befestigungsschrauben des Hornes wiedereinschrauben
- das Frontgitter wieder in die dazu bestimmten seitlichen Vertiefungen einlegen und die Schrauben des Netzes wiedereindrehen.

INSTALLATION DES LAUTSPRECHERS

ACHTUNG



Den Lautsprecher auf eine stabile und sichere Art und Weise installieren, um jede Gefahr für Personen oder Sachschäden zu vermeiden.

Um gefährliche Situationen zu vermeiden, nie mehrere Lautsprecher ohne angemessene Abspannsysteme aneinander anschließen.

Bevor man den Lautsprecher aufhängt, alle Teile kontrollieren, sie sollen keine Schäden oder Verformungen, keine fehlenden oder beschädigten Teile haben, die eine sichere Installation beeinträchtigen könnten.

Bei Verwendung im Freien sollte man darauf achten, das die Lautsprecher vor witterungseinflüssen wie Sturm, Regen, Hagel, Schnee, usw. geschützt sind.

Der Lautsprecher ist für folgende Verwendungen geeignet:

- auf einer Distanzstange
- auf dem Boden (als Monitor)
- auf einem Ständer
- mit zugelassenen Ringschrauben
- mit dazu bestimmten Bügeln aufgehängt

ACHTUNG



Hängen Sie den Lautsprecher nie an den Griffen auf!
Mit den Griffen ausschließlich für die Handhabung der einzelnen Lautsprecher.

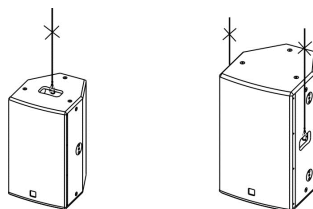

ACHTUNG



Um den Lautsprecher zu hängen, nur eine Schraube für jede Hängestelle verwenden.
Die Hängestellen sind M8 für DVX P8 und DVX P10 oder M10 für DVX P12 und DVX P15.

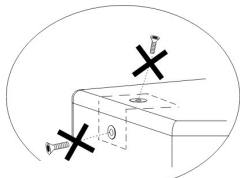

NEIN!

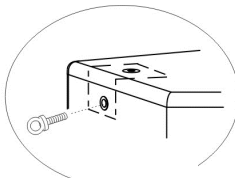

JA!

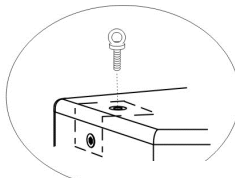

JA!

TECHNISCHE DATEN

	DVX P8	DVX P10
System	Passive – 2 way	Passive – 2 way
RMS Power	300W	300W
Peak Power	600W	600W
Frequenzgang (-10dB)	75Hz-20KHz	70Hz-20KHz
(-6dB)	100Hz-20KHz	90Hz-20KHz
Crossover	1800Hz	1800Hz
Sensibilität 1W@1m	94dB	96dB
Schalldruck (SPL)	125dBmax	127dBmax
Lautsprecher	1 Woofer 8" 2" Coil 1x1" Compression Diver Neodimio 1.5" voice coil	1 Woofer 10" 2" Coil 1x1" Compression Diver Neodimio 1.5" voice coil
Impedanz Eingang	8ohm	8ohm
Filter	18dB/oct HIGH PASS 12dB/oct LOW PASS	18dB/oct HIGH PASS 12dB/oct LOW PASS
Abstrahlcharakteristik	90°x70° (rotatable)	90°x70° (rotatable)
Audio-Anschlüsse	2 x SPEAKON In parallel	2 x SPEAKON In parallel
Abmessungen (WxHxD)	250x425x260mm 9.8x16.7x10.2inch.	290x510x310mm 11.4x20.1x12.2 inch.
Gewicht	9.8Kg 21.6lbs	12.5Kg 27.6lbs
Mechanik		
Box material	Sperrholz	Sperrholz
Farbe	Schwarz	Schwarz
Griff	1 x housing (oben)	1 x housing (oben)
Flugmöglichkeiten	12 x M8 2 x Quicklock-Pin	12 x M8 2 x Quicklock-Pin
Ständerflansch	D36mm (alluminium)	D36mm (alluminium)
Frontal netz	Perforierte Metallplatte 1.2mm + foam	Perforierte Metallplatte 1.2mm + foam

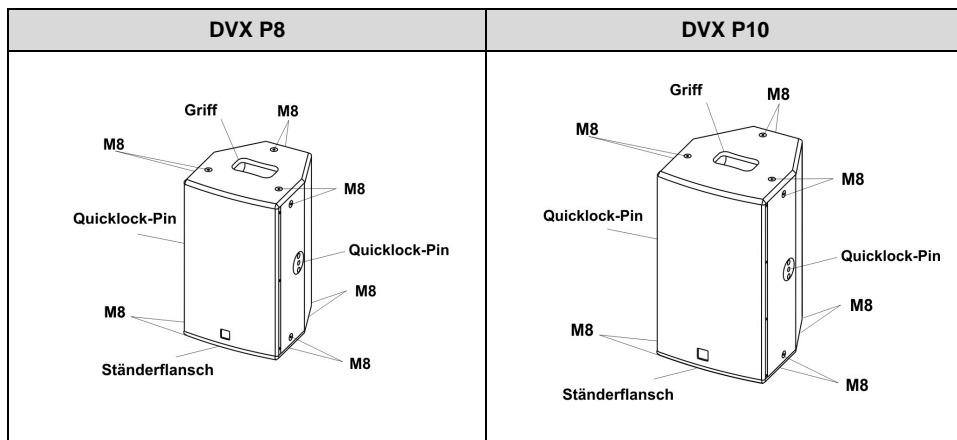

TECHNISCHE DATEN

	DVX P12	DVX P15
System	Passive – 2 way	Passive – 2 way
RMS Power	500W	500W
Peak Power	1000W	1000W
Frequenzgang (-10dB)	60Hz-20KHz	60Hz-20KHz
(-6dB)	90Hz-20KHz	70Hz-20KHz
Crossover	1400Hz	1400Hz
Sensibilität 1W@1m	100dB	100dB
Schalldruck (SPL)	133dBmax	133dBmax
Lautsprecher	1 Woofer 12" 3" Coil 1x1.4" Compression Diver Neodimio 2.5" voice coil Dome al Titanium	1 Woofer 15" 3" Coil 1x1.4" Compression Diver Neodimio 2.5" voice coil Dome al Titanium
Impedanz Eingang	8ohm	8ohm
Filter	18dB/oct HIGH PASS 12dB/oct LOW PASS	18dB/oct HIGH PASS 12dB/oct LOW PASS
Abstrahlcharakteristik	90°x40° (rotatable)	90°x40° (rotatable)
Audio-Anschlüsse	2 x SPEAKON In parallel	2 x SPEAKON In parallel
Abmessungen (WxHxD)	370x625x395mm 14.6x24.6x15.5inch.	430x690x450mm 16.9x27.2x17.7inch.
Gewicht	23.2Kg 51.1lbs	26.1Kg 57.5lbs
Mechanik		
Box material	Sperrholz	Sperrholz
Farbe	Schwarz	Schwarz
Griff	2 x housing (1 x Seite)	2 x housing (1 x Seite)
Flugmöglichkeiten	12 x M10 4 x Quicklock-Pin	12 x M10 4 x Quicklock-Pin
Ständerflansch	D36mm (alluminium)	D36mm (alluminium)
Frontal netz	Perforierte Metallplatte 1.5mm + foam	Perforierte Metallplatte 1.5mm + foam

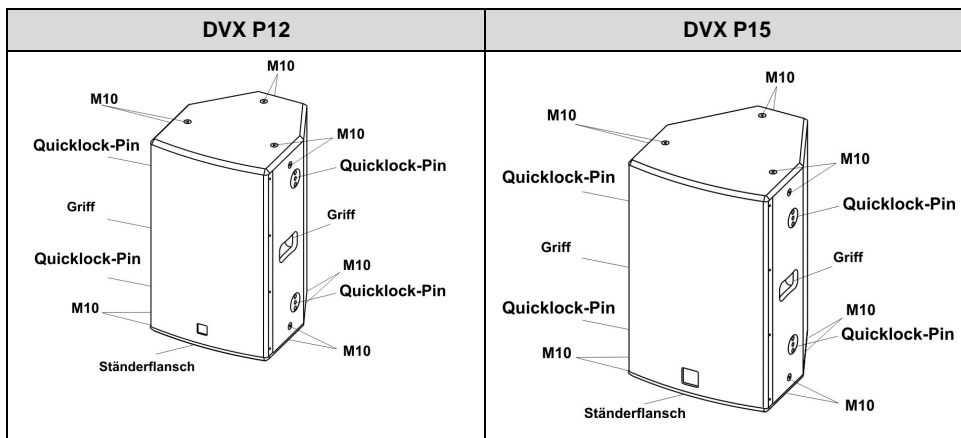
**TECHNISCHE DATEN**

DVX P215

System	Passive – 2 way
RMS Power (Full Range) (Bi Amp)	1000W 900W (Woofer) + 90W (Driver)
Peak Power	2000W
Frequenzgang (-10dB Full range) (-6dB Full range) (Bi Amp)	60Hz-20KHz 66Hz-20KHz 60Hz-2KHz (Woofer) 700Hz-20KHz (Driver)
Crossover	1300Hz
Sensibilität 1W@1m	103dB
Schalldruck (SPL)	136dB
Lautsprecher	2x15" Woofer VC 3" 1x1.4" Comp. Driver Neo VC 2.5" Dome al Titanio
Impedanz (Full range) (Bi Amp)	4ohm 4ohm (Woofer) + 8ohm (Driver)
Filter	18dB/oct HIGH PASS 12dB/oct LOW PASS
Abstrahlcharakteristik	60°x40° (rotatable)
Audio-Anschlüsse	2 x SPEAKON In parallel
Abmessungen (WxHxD)	446x500x1202mm 17.6x19.7x47.3inch.
Gewicht	47Kg 103.6lbs
Mechanik	
Box material	Sperrholz
Farbe	Schwarz
Griff	4 x housing
Flugmöglichkeiten	11 x M10
Support	Stellfuß
Frontalnetz	Perforierte Metallplatte 1.5mm + foam

DVX P215

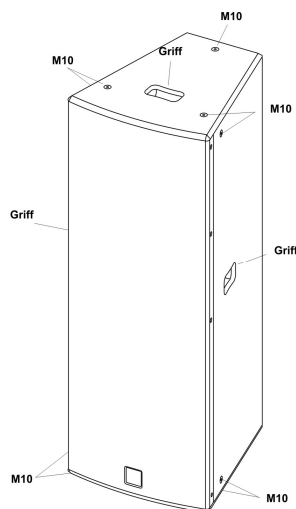

Front view

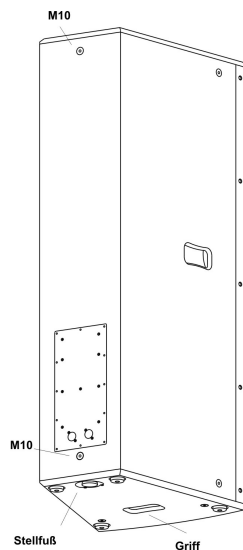

Rear view

DESCRIPTION

“DVX P” est une série de diffuseurs passifs en bois à deux voies, étudiés pour la sonorisation des lieux moyennement grands.

Les diffuseurs de la série DVX P sont pourvus d'un filtre passif avec pente 12dB/oct pour la section graves, 18dB/oct pour la section aigus ainsi que d'une protection thermique auto-rétablissante sur le driver afin d'éviter des surcharges prolongées.

DVX P8

Le diffuseur passifs DVX P8 est équipé avec un haut-parleur de graves 8” (bobine acoustique 2”) et un driver de compression de 1” (bobine acoustique 1,5”) monté sur un cornet avec dispersion 90°x70°.

Le diffuseur est fourni avec le cornet orienté à 90° dans le sens horizontal et 70° dans le sens vertical.

Le diffuseur est fabriqué avec 1 poigné, les 12 points M8 et les 2 points flypins situés sur les côtés et sur le derrière du diffuseur en facilitent l'installation et le transport.

Le diffuseur a également été conçu pour l'utilisation en soutien comme moniteur (angle 45°) ; en tournant le cornet, il est possible de maintenir ce même angle de couverture même avec l'utilisation du moniteur.

Dans la partie inférieure de la box, figure un support sur pied standard (D36mm) en aluminium.

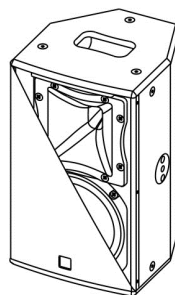

DVX P10

Le diffuseur passifs DVX P10 est équipé avec un haut-parleur de graves 10” (bobine acoustique 2”) et un driver de compression de 1” (bobine acoustique 1,5”) monté sur un cornet avec dispersion 90°x70°.

Le diffuseur est fourni avec le cornet orienté à 90° dans le sens horizontal et 70° dans le sens vertical.

Le diffuseur est fabriqué avec 1 poigné, les 12 points M8 et les 2 points flypins situés sur les côtés et sur le derrière du diffuseur en facilitent l'installation et le transport.

Le diffuseur a également été conçu pour l'utilisation en soutien comme moniteur (angle 45°) ; en tournant le cornet, il est possible de maintenir ce même angle de couverture même avec l'utilisation du moniteur.

Dans la partie inférieure de la box, figure un support sur pied standard (D36mm) en aluminium.

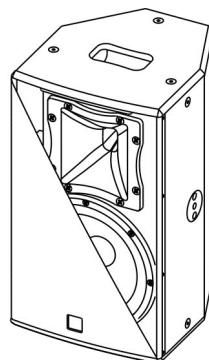

DVX P12

Le diffuseur passifs DVX P12 est équipé avec un haut-parleur de graves 12" (bobine acoustique 3") et un driver de compression de 1,4" (bobine acoustique 2.5") monté sur un cornet en aluminium avec dispersion 90°x40°.

Le diffuseur est fourni avec le cornet orienté à 90° dans le sens horizontal et 40° dans le sens vertical.

Le diffuseur est fabriqué avec les 2 poignées, les 12 points M10 et les 4 points flypins situés sur les côtés et sur le derrière du diffuseur en facilitent l'installation et le transport.

Le diffuseur a également été conçu pour l'utilisation en soutien comme moniteur (angle 45°) ; en tournant le cornet, il est possible de maintenir ce même angle de couverture même avec l'utilisation du moniteur.

Dans la partie inférieure de la box, figure un support sur pied standard (D36mm) en aluminium.

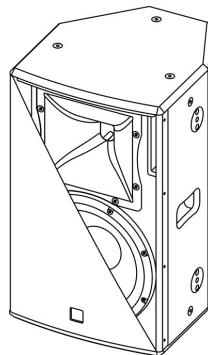
**DVX P15**

Le diffuseur passifs DVX P15 est équipé avec un haut-parleur de graves 15" (bobine acoustique 3") et un driver de compression de 1,4" (bobine acoustique 2.5") monté sur un cornet en aluminium avec dispersion 90°x40°.

Le diffuseur est fourni avec le cornet orienté à 90° dans le sens horizontal et 40° dans le sens vertical.

Le diffuseur est fabriqué avec les 2 poignées, les 12 points M10 et les 4 points flypins situés sur les côtés et sur le derrière du diffuseur en facilitent l'installation et le transport.

Le diffuseur a également été conçu pour l'utilisation en soutien comme moniteur (angle 45°) ; en tournant le cornet, il est possible de maintenir ce même angle de couverture même avec l'utilisation du moniteur.

Dans la partie inférieure de la box, figure un support sur pied standard (D36mm) en aluminium.

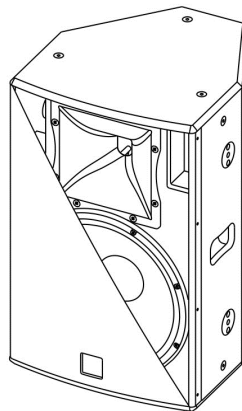

DVX P215

Le diffuseur passifs DVX P215 est équipé avec deux haut-parleur de graves 15" (bobine acoustique 3") et un driver de compression de 1,4" (bobine acoustique 2.5") monté sur un cornet en aluminium avec dispersion 60°x40°.

Le diffuseur est fourni avec le cornet orienté à 60° dans le sens horizontal et 40° dans le sens vertical et avec la connexion interne mis à fonctionner Full Range.

Retrait du panneau arrière, vous pouvez régler le fonctionnement du diffuseur Bi-Amp. (Voir page 41).

Le diffuseur est fabriqué avec les 4 poignées, les 11 points M10 situés sur les côtés et sur le derrière du diffuseur en facilitent l'installation et le transport.

Dans la partie inférieure de la boîte il ya un pied réglable pour faire varier l'inclinaison et ajuster l'inclinaison pour un fonctionnement correct.

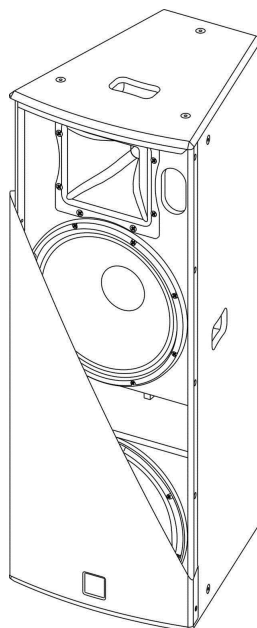

CONNEXIONS



ATTENTION

A fin d'éviter les risques de chocs électriques, ne pas relier le diffuseur avec l'amplificateur allumé. Avant de faire fonctionner le diffuseur, vérifier attentivement que les connexions soient bien faites afin d'éviter des courts-circuits ou des connexions erronées.

Deux connecteurs Speakon à 4 pôles: une prise permet l'entrée du signal audio, alors que la deuxième prise peut être utilisée comme sortie pour la connexion en parallèle d'un autre diffuseur, sont situés dans le panneau des connexions situé sur le côté postérieur du diffuseur.

Les connexions sur les connecteurs sont:

- 1+ pour le signal positif
- 1- pour le signal négatif (masse)
- 2+ non connecté
- 2- non connecté

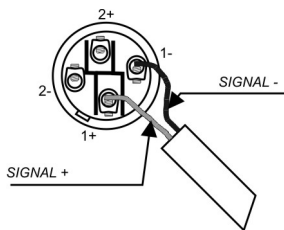

pour:
DVX P8
DVX P10
DVX P12
DVX P15
DVX P215 (FULL RANGE MODE)

Dans le cas où l'on souhaite relancer le signal amplifié, d'un diffuseur à un autre, il faut prêter une attention particulière à l'impédance nominale qui dérive de la connexion, qui ne devra jamais être inférieure à l'impédance minimale de l'amplificateur de puissance. Ceci pour éviter des sur-réchauffements anormaux ou, pire encore, des dégâts à l'amplificateur.

Les diffuseurs "DVX P" ont une impédance nominale d'entrée de 8 ohm, et il faudra se référer à celle-ci pour les connexions.

ROTATION CONE

Les diffuseurs de la série "DVX P" permettent de maintenir le même angle de couverture, au moyen de la rotation du cône, dans le cas d'une utilisation en position horizontale.

Si on veut modifier l'angle de couverture du cône, il faut nécessairement:

- dévisser les vis de fixation du réseau
- enlever la protection antérieure en exerçant une légère pression sur un côté et en la soulevant de ses encastremets.
- dévisser les huit vis de fixation du cône
- faire rouler le cône dans la position désirée (ne jamais extraire le bloc cône du diffuseur)
- revisser les vis de fixation du cône
- insérer à nouveau la protection dans les encastremets latéraux et revisser les vis du réseau.

INSTALLATION DU DIFFUSEUR

ATTENTION



Installer le diffuseur de façon stable et sûre afin d'éviter toute condition de danger pour l'intégrité des personnes et des structures.

Afin d'éviter les conditions de danger, ne pas superposer entre eux plusieurs diffuseurs sans systèmes d'ancrage appropriés. Avant de suspendre le diffuseur, contrôler tous les composants à utiliser, qui ne doivent présenter aucun dommage, aucune déformation ou partie manquante ou abimée qui seraient susceptibles de réduire la sécurité de l'installation.

Lors de l'utilisation en espace aérés, éviter les lieux exposés aux intempéries.

Le diffuseur est fourni par l'entreprise qui le fabrique et il est prédisposé pour l'utilisation:

- en appui
- au sol (comme écran)
- sur support mât
- en suspension avec les anneaux ou les étriers appropriés fournis par l'entreprise

ATTENTION



Ne jamais utiliser les poignées pour suspendre l'enceinte!

Utilisez les poignées exclusivement pour la gestion du haut-parleur unique.

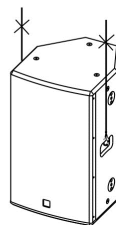
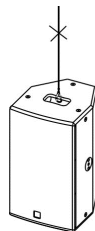

ATTENTION

Utiliser une seule vis pour chaque point de suspension pour accrocher le diffuseur

Les points de suspension sont de M8 pour DVX P8 et DVX P10 ou bien de M10 pour DVX P12 et DVX P15.

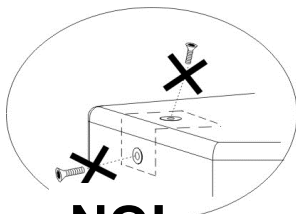

NO!

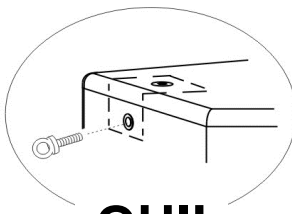

OUI!

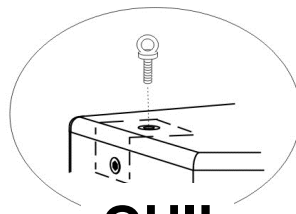

OUI!

DONNES TECHNIQUES

	DVX P8	DVX P10
Système	Passifs – 2 vie	Passifs – 2 vie
Puissance RMS	300W	300W
Puissance Peak	600W	600W
Réponse en fréquence (-10dB)	75Hz-20KHz	70Hz-20KHz
(-6dB)	100Hz-20KHz	90Hz-20KHz
Crossover	1800Hz	1800Hz
Sensibilité 1W@1m	94dB	96dB
Pression sonore ((SPL)	125dBmax	127dBmax
Composantes	1 Woofer 8" 2" Coil 1x1" Compression Diver Neodimio 1.5" voice coil	1 Woofer 10" 2" Coil 1x1" Compression Diver Neodimio 1.5" voice coil
Impedance entrée	8ohm	8ohm
Filtres	18dB/oct passe-haut 12dB/oct passe-bas	18dB/oct passe-haut 12dB/oct passe-bas
Dispersion	90°x70° (rotabile)	90°x70° (rotabile)
Connecteurs audio	2 x SPEAKON parallèle	2 x SPEAKON parallèle
Dimensions (WxHxD)	250x425x260mm 9.8x16.7x10.2inch.	290x510x310mm 11.4x20.1x12.2 inch.
Poids	9.8Kg 21.6lbs	12.5Kg 27.6lbs
Mécanique		
Matériel box	Bois	Bois
Couleurpeinture	Noir	Noir
Poignée	1 x intégré (au-dessus)	1 x intégré (au-dessus)
Points de fixation	12 x M8 2 x flypin	12 x M8 2 x flypin
Stand support	D36mm (alluminium)	D36mm (alluminium)
Grille avant	Plaque perforée 1.2mm + foam	Plaque perforée 1.2mm + foam

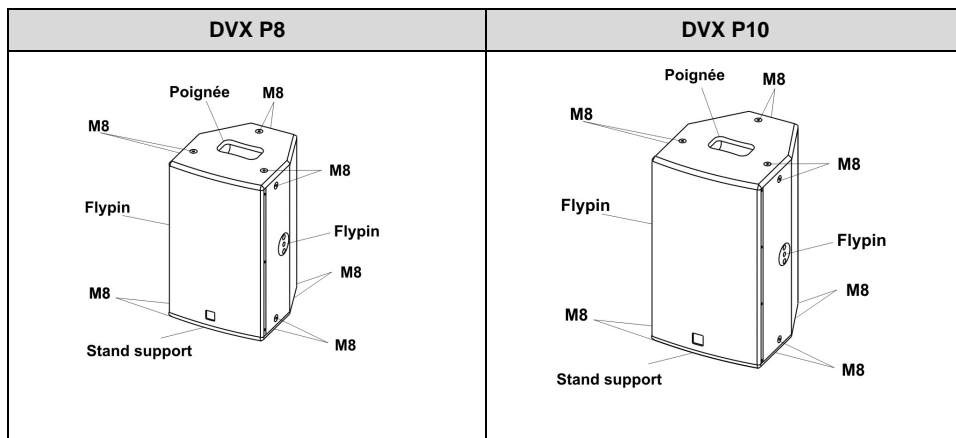
**DONNES TECHNIQUES**

	DVX P12	DVX P15
Système	Passivo – 2 vie	Passivo – 2 vie
Puissance RMS	500W	500W
Puissance Peak	1000W	1000W
Réponse en fréquence (-10dB)	60Hz-20KHz	60Hz-20KHz
(-6dB)	90Hz-20KHz	70Hz-20KHz
Crossover	1400Hz	1400Hz
Sensibilité 1W@1m	100dB	100dB
Pression sonore ((SPL)	133dBmax	133dBmax
Composantes	1 Woofer 12" 3" Coil 1x1.4" Compression Diver Neodimio 2.5" voice coil Dome al Titanium	1 Woofer 15" 3" Coil 1x1.4" Compression Diver Neodimio 2.5" voice coil Dome al Titanium
Impedance entrée	8ohm	8ohm
Filtres	18dB/oct passe-haut 12dB/oct passe-bas	18dB/oct passe-haut 12dB/oct passe-bas
Dispersion	90°x40° (rotabile)	90°x40° (rotabile)
Connecteurs audio	2 x SPEAKON parallèle	2 x SPEAKON parallèle
Dimensions (WxHxD)	370x625x395mm 14.6x24.6x15.5inch.	430x690x450mm 16.9x27.2x17.7inch.
Poids	23.2Kg 51.1lbs	26.1Kg 57.5lbs
Mécanique		
Matériel box	Bois	Bois
Couleurpeinture	Noir	Noir
Poignée	2 x intégré (1 x côté)	2 x intégré (1 x côté)
Points de fixation	12 x M10 4 x flypin	12 x M10 4 x flypin
Stand support	D36mm (alluminium)	D36mm (alluminium)
Grille avant	Plaque perforée 1.5mm + foam	Plaque perforée 1.5mm + foam

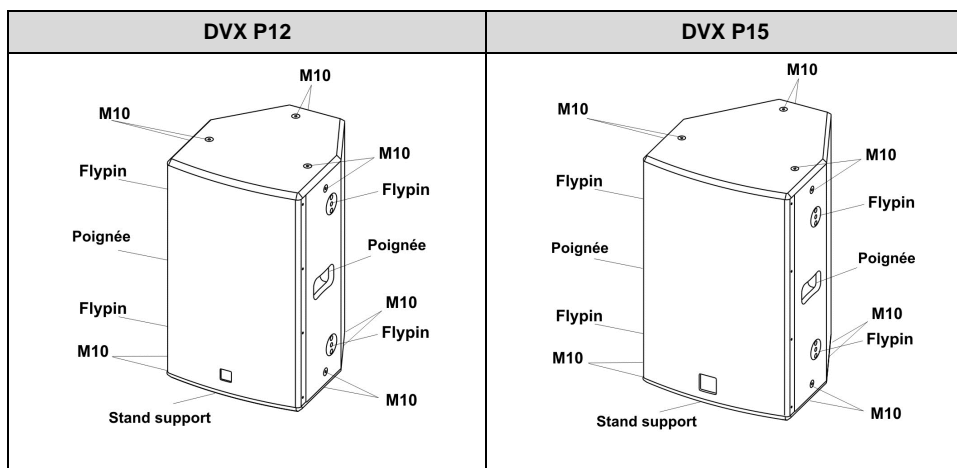
**DONNES TECHNIQUES**

DVX P215

Système	Passivo – 2 vie
Puissance RMS (Full Range) (Bi Amp)	1000W 900W (Woofer) + 90W (Driver)
Puissance Peak	2000W
Réponse en fréquence (-10dB Full range) (-6dB Full range) (Bi Amp)	60Hz-20KHz 66Hz-20KHz 60Hz-2KHz (Woofer) 700Hz-20KHz (Driver)
Crossover	1300Hz
Sensibilité 1W@1m	103dB
Pression sonore (SPL)	136dB
Composantes	2x15" Woofer VC 3" 1x1.4" Comp. Driver Neo VC 2.5" Dome al Titanio
Impedance (Full range) (Bi Amp)	4ohm 4ohm (Woofer) + 8ohm (Driver)
Filtres	18dB/oct passe-haut 12dB/oct passe-bas
Dispersion	60°x40° (rotable)
Connecteurs audio	2 x SPEAKON parallèle
Dimensions (WxHxD)	446x500x1202mm 17.6x19.7x47.3inch.
Poids	47Kg 103.6lbs
Mécanique	
Matériel box	Bois
Couleur/peinture	Noir
Poignée	2 x intégré
Points de fixation	11 x M10
Support	Pied réglable
Grille avant	Plaque perforée 1.5mm + foam

DVX P215

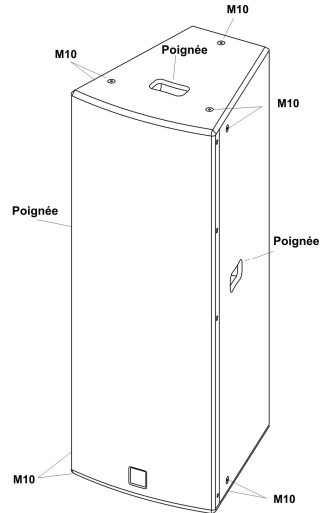

Front view

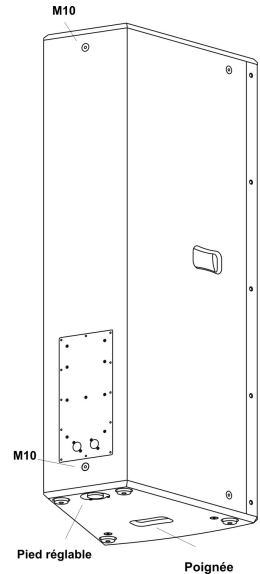

Rear view

DIMENSIONI - DIMENSIONS
ABMESSUNGEN - DIMENSIONS

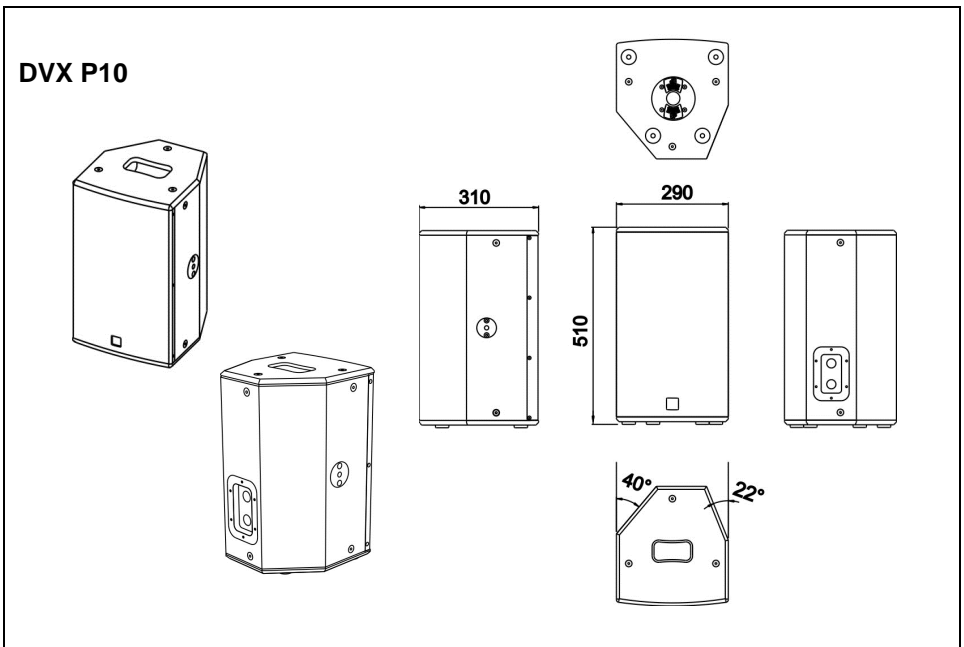
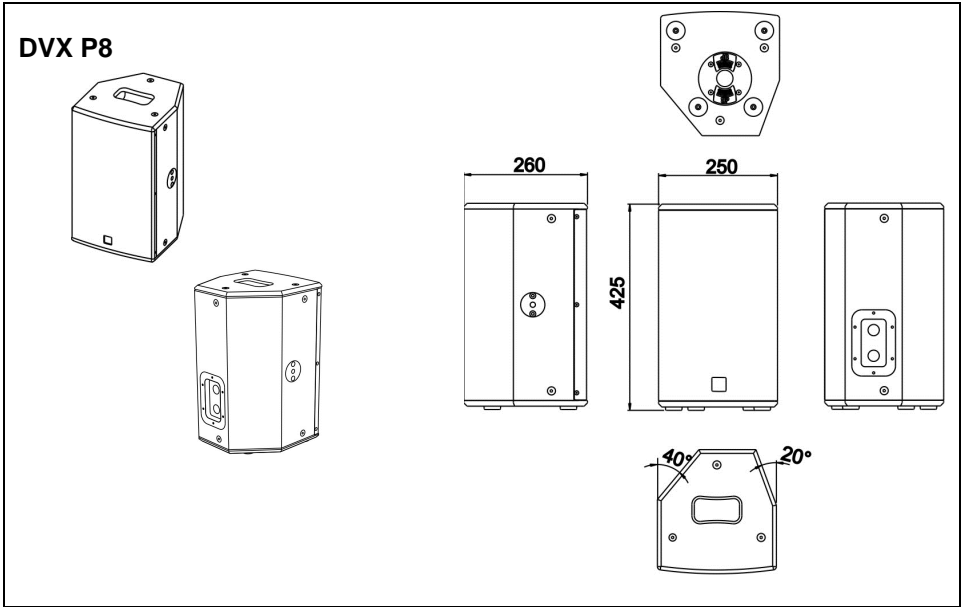

DIMENSIONI - DIMENSIONS
ABMESSUNGEN - DIMENSIONS

DVX P12

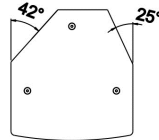
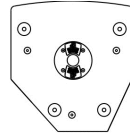
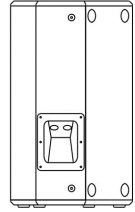
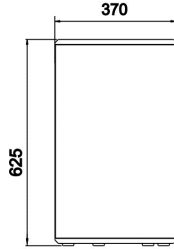
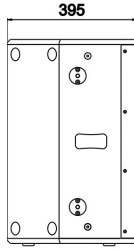
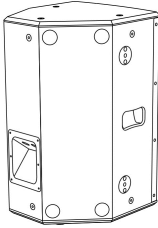
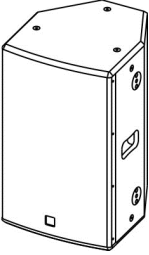

DVX P15

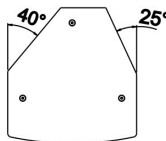
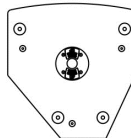
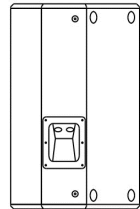
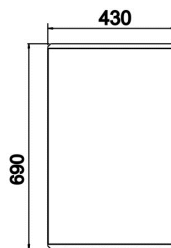
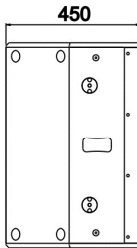
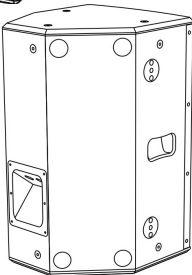
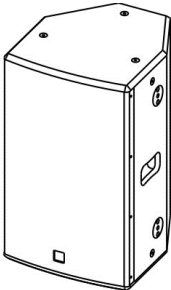

DIMENSIONI - DIMENSIONS
ABMESSUNGEN - DIMENSIONS

DVX P215

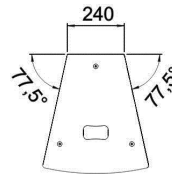
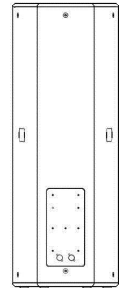
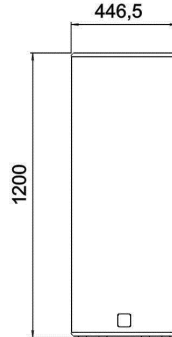
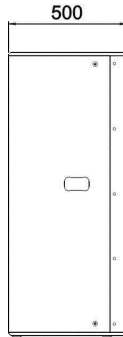
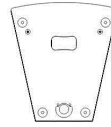
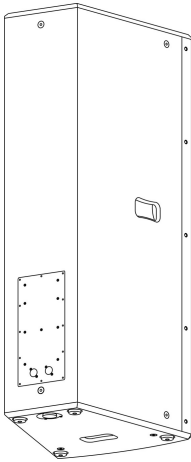
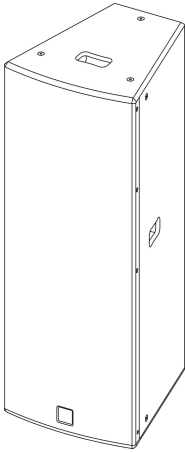

SCHEMA A BLOCCHI - BLOCK DIAGRAM
BLOCKSCHALTBILD - SCHEMAS FONCTIONNELS

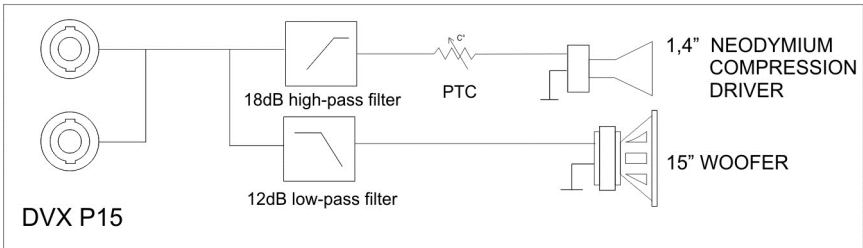
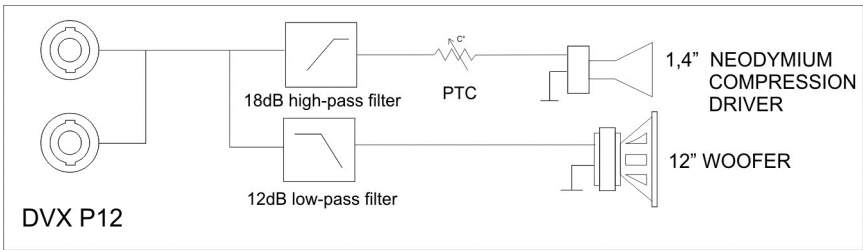
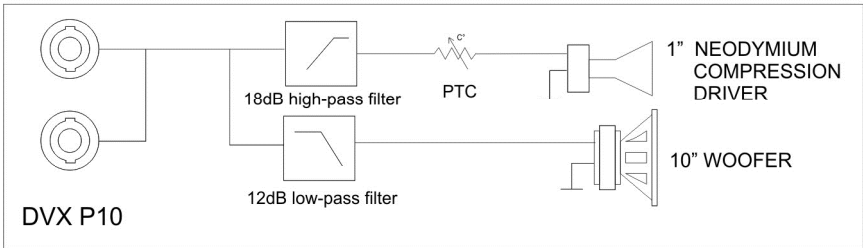
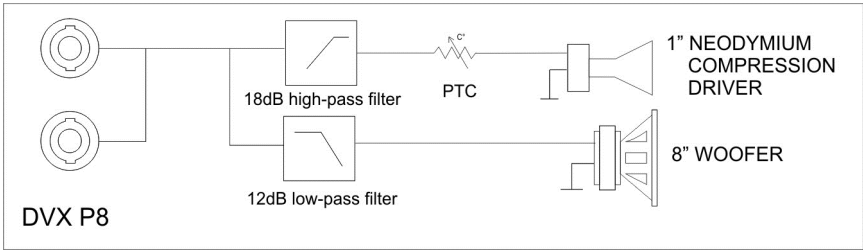

SCHEMA A BLOCCHI - BLOCK DIAGRAM

BLOCKSCHALTBILD - SCHEMAS FONCTIONNELS

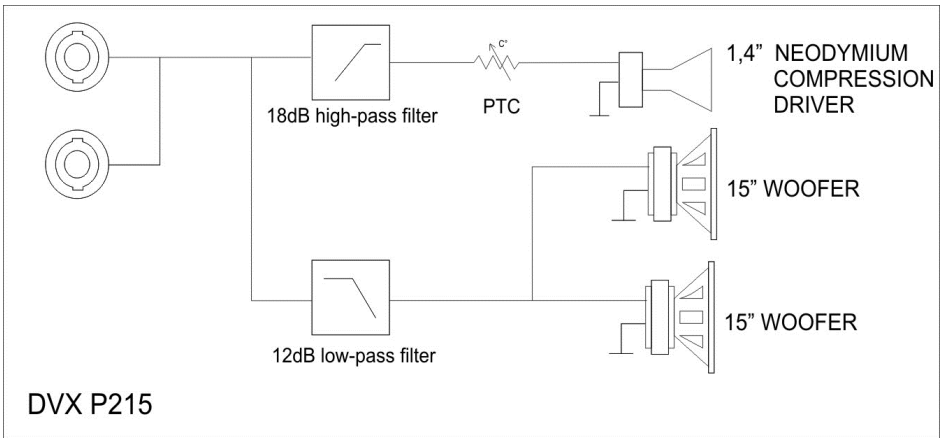

**ANGOLO DI COPERTURA TROMBA / HORN ANGLE COVERAGE
HOCHTONHORN ABSTRAHLWINKEL / ANGLE DE COUVERTURE COTE**

DVX P8
DVX P10

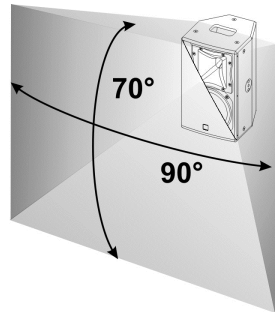
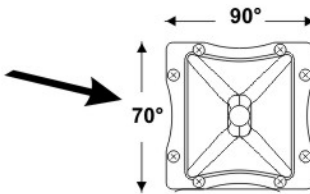
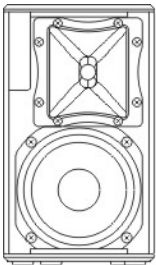

Utilizzo a pavimento (monitor) con tromba ruotata
 Floor use (monitor) with rotated horn.
 Verwendung auf dem Boden (monitor) mit gedrehtem
 Horn.
 Utilisation au sol (écran) avec cône tourné

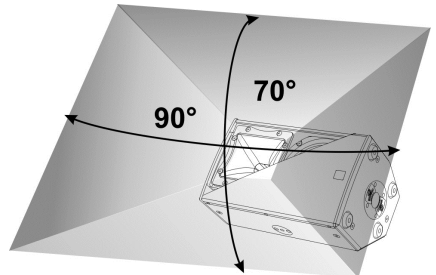

ANGOLO DI COPERTURA TROMBA / HORN ANGLE COVERAGE

HOCHTONHORN ABSTRAHLWINKEL / ANGLE DE COUVERTURE COTE

DVX P12
DVX P15

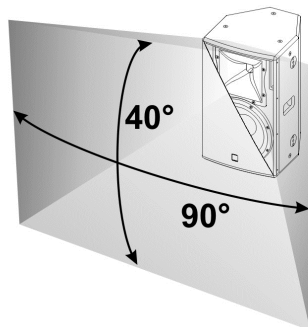
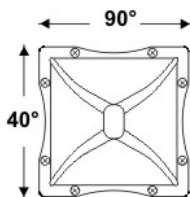
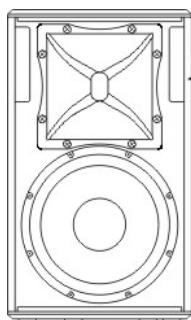

Utilizzo a pavimento (monitor) con tromba ruotata
Floor use (monitor) with rotated horn.
Verwendung auf dem Boden (monitor) mit
gedrehtem Horn.
Utilisation au sol (écran) avec cône tourney

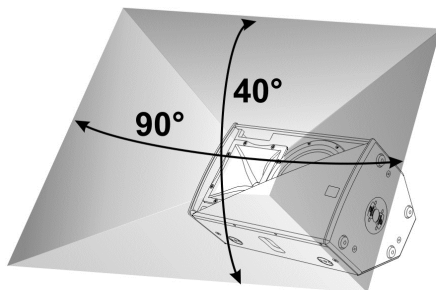

DVX P215

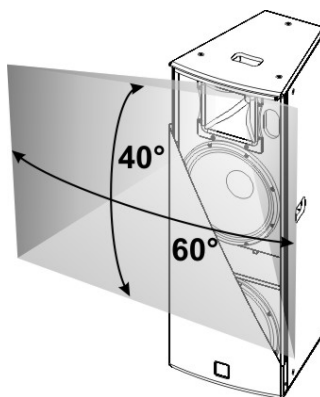
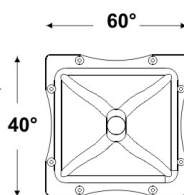
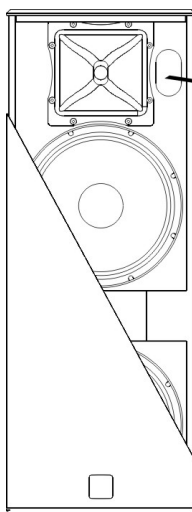

INSTALLAZIONE / INSTALLATION

INSTALLATIONEN / INSTALLATIONS

UTILIZZO IN APPOGGIO
SUPPORTED USE
ANWENDUNG
UTILISATION EN APPUI

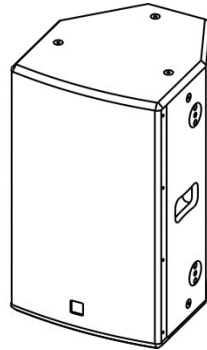
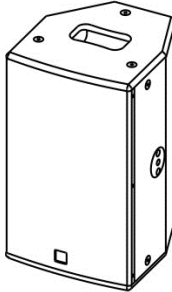

SUPPORTO PIANTANA STANDARD (D36M)
STANDARD STAND (D36MM)
STANDARD-HOCHSTÄNDERFLANSCH (D36MM)
SUPPORT STANDARD (D36MM)

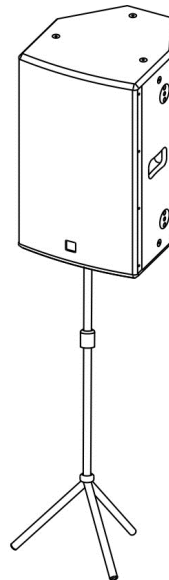
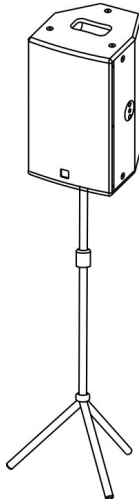

UTILIZZO A PAVIMENTO (MONITOR)
FLOOR USE (MONITOR)
VERWENDUNG AUF DEM BODEN (MONITOR)
UTILISATION AU SOL (ÉCRAN)

Per / For DVX P12
DVX P15

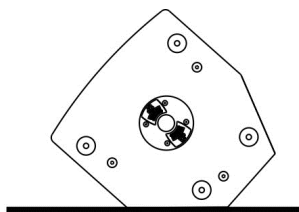
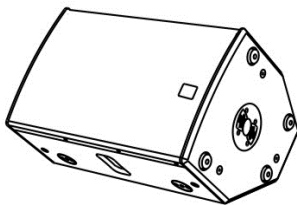

Nota: E' possibile montare 4 piedi in gomma sul fianco per utilizzo in appoggio (in dotazione)

Note: It is possible to mount 4 rubber feet on the side for bookshelf use (provided)

Anmerkung: Zur Verwendung als Boden-Monitor können die 4 beiliegende GummifüÙe montiert werden.

Note: Il est possible de monter quatre pieds caoutchouc sur le coté pour une utilisation en appui (en dotation)

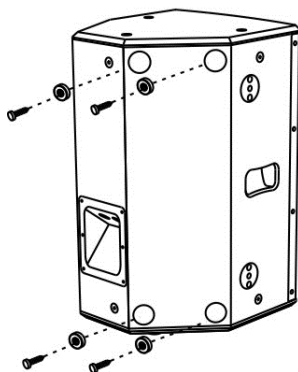

ISTRUZIONI DI SICUREZZA PER ACCESSORI
SAFETY INSTRUCTIONS FOR ACCESSORIES
ZUBEHÖR SICHERHEITSHINWEISE
INSTRUCTIONS DE SÉCURITÉ POUR LES ACCESSOIRES



Contactare dB Technologies per gli accessori da utilizzare a corredo.

Si declina ogni responsabilità da un utilizzo inappropriato degli accessori o di dispositivi aggiuntivi non idonei allo scopo.

Contact dB Technologies for accessories to be used with speakers.

Will not accept any responsibility when inappropriate accessories or not suitable additional devices are used.

Kontaktieren sie dBTechnologies für passendes Lautsprecherzubehör.

Falls unpassendes Zubehör verwendet wird, wird jegliche Haftung ausgeschlossen.

Contact dBTechnologies pour les accessoires à utiliser avec la machine.

N'accepterons pas toutes les responsabilités lorsque des accessoires inappropriés ou ne conviennent pas à des dispositifs supplémentaires sont utilisés.

ACCESSORI - ACCESSORIES

ZUBEHÖR - ACCESSOIRES

**KIT COMPLETO SUPPORSO PIANTANA
STAND SUPPORT COMPLETE KIT**

- opzione DTF 8 --> DVX P8
- option DTF 8 --> DVX P8
- opzione DTF 10 --> DVX P10
- option DTF 10 --> DVX P10

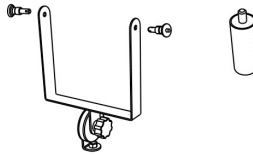

Staffa supporto piantana
Stand adaptor

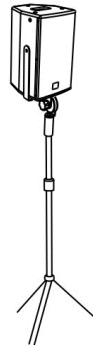
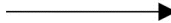
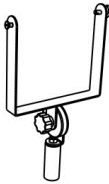

**KIT COMPLETO APPENDIBILITA'
HANG SYSTEM COMPLETE KIT**

- opzione DTF 8A --> DXV P8
- option DTF 8A --> DXV P8
- opzione DTF 10A --> DXV P10
- option DTF 10A --> DXV P10

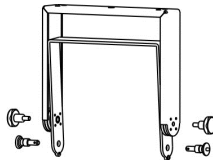

*Gli accessori per il fissaggio della staffa non sono forniti in dotazione
The fixing accessory for wall bracket are not supplying with the kit*

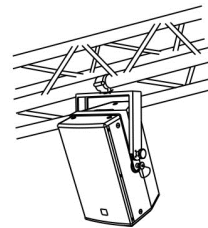
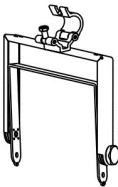

Fissaggio a muro
For wall bracket

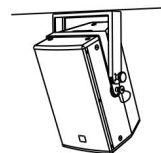

KIT COMPLETO APPENDIBILITA'
HANG SYSTEM COMPLETE KIT

opzione DTF 12 --> DXV P12
option DTF 12 --> DXV P12
opzione DTF 15 --> DXV P15
option DTF 15 --> DXV P15

*Gli accessori per il fissaggio della staffa
non sono forniti in dotazione*
*The fixing accessory for wall bracket
are not supplying with the kit*

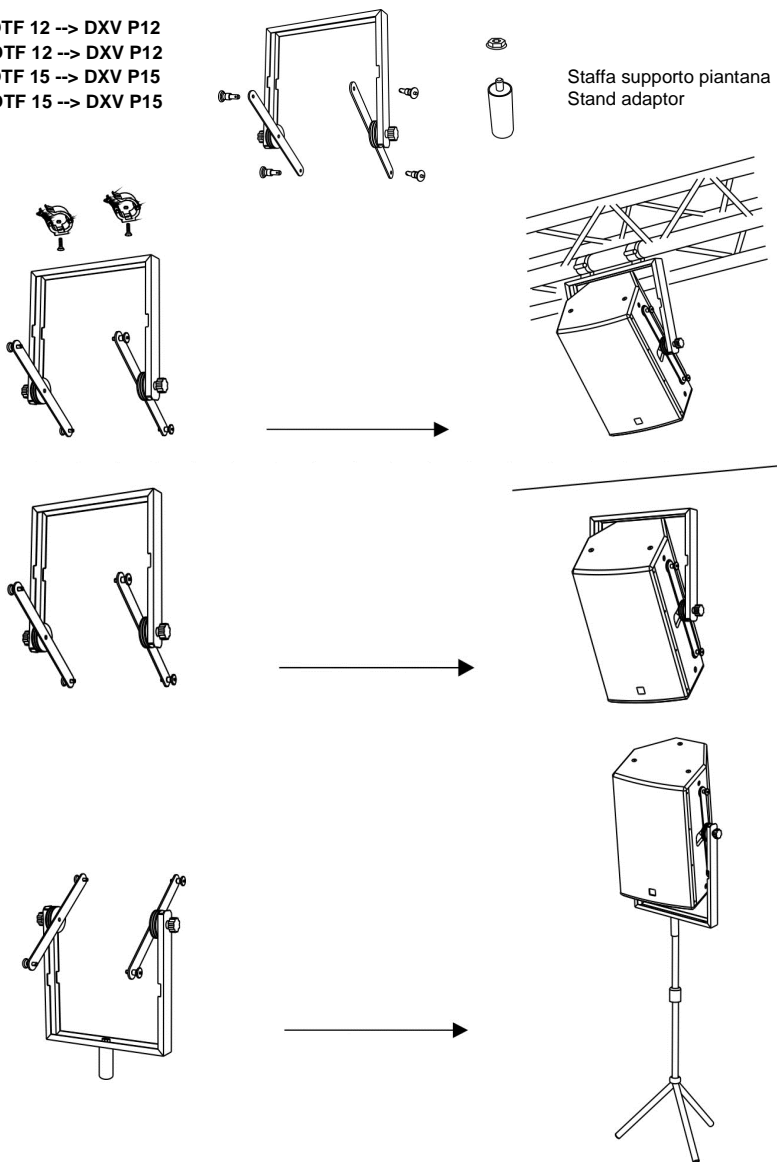

**APPENDIBILITA' TRAMITE GOLFARI
SUSPENDABLE WITH EYEBOLTS**

opzione TE M8 --> DXV P8 / DXV P10
option TE M8 --> DXV P8 / DXV P10

L'opzione include solo i golfari.
The option including eyebolts only.

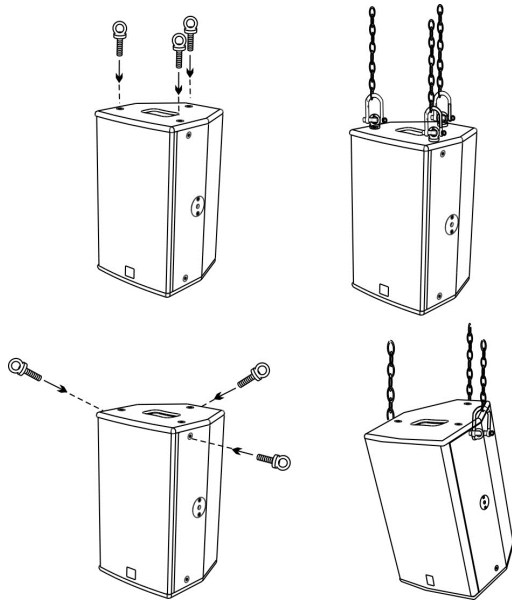

**APPENDIBILITA' TRAMITE GOLFARI
SUSPENDABLE WITH EYEBOLTS**

opzione TE M10 --> DXV P12 / DXV P15
option TE M10 --> DXV P12 / DXV P15

L'opzione include solo i golfari.
The option including eyebolts only.

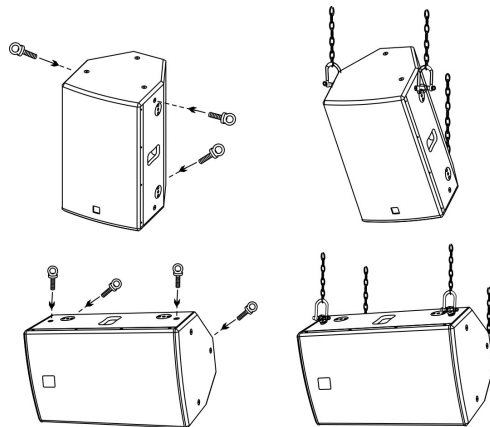

KIT COMPLETO APPENDIBILITA' A MURO
WALL HANG SYSTEM COMPLETE KIT

opzione WB 09 --> DXV P8 / DXV P10
DXV P12 / DXV P15
option WB 09 --> DXV P8 / DXV P10
DXV P12 / DXV P15

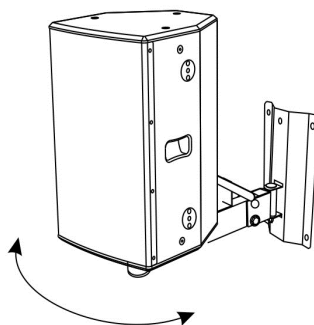
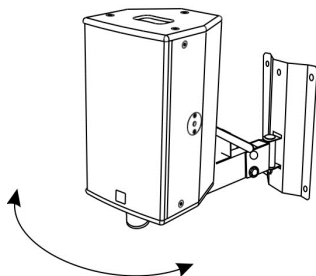
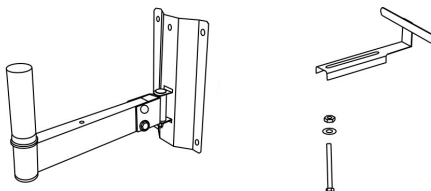

CONFIGURAZIONE DVX P215 BI-AMP
DVX P215 BI-AMP MODE CONFIGURATION
KONFIGURATION DVX P215 BI-AMP MODE
CONFIGURATION DVX P215 BI-AMP MODE



ATTENZIONE-WARNING-ACHTUNG-ATTENTION

Al fine di evitare danni ai componenti, assicurarsi che l'amplificatore eroghi una potenza coerente con le specifiche tecniche indicate a pag.7.

In order to avoid damage to components, make sure that the amplifier delivers a power consistent with the technical specifications on page.14.

Um eine Beschädigung von Bauteilen zu vermeiden, stellen Sie sicher, dass der Verstärker eine Leistung liefert, die mit den technischen Daten auf Seite 21 zusammenhängend ist.

Afin d'éviter d'endommager les composants, assurez-vous que l'amplificateur délivre une puissance compatible avec les spécifications techniques à la page 28.



ATTENZIONE-WARNING-ACHTUNG-ATTENTION

La frequenza di taglio woofer driver dovrà essere impostata secondo le specifiche riportate a pag.7 al fine di ottenere il miglior risultato acustico ed evitare danni al driver.

The cutoff frequency woofer driver must be set according to the specifications described on page 14 in order to get the best sound and avoid damage to the driver

Die Grenzfrequenz Woofer-Driver muss entsprechend den auf Seite 21 beschriebenen Spezifikationen angelegt werden, um das beste akustische Ergebnis zu erhalten und um Schäden ans Driver zu vermeiden.

Le woofer driver de fréquence de coupure doit être réglé selon les spécifications décrites à la page 28 pour obtenir le meilleur son et éviter d'endommager le conducteur.



ATTENZIONE-WARNING-ACHTUNG-ATTENTION

Anche in caso di configurazione Bi-Amp rimane attiva la protezione termica autoripristinante (PTC).

Even in the case of Bi-Amp configuration remains active thermal protection (PTC).

Falls eine Bi-Amp-Konfiguration, bleibt der thermischen Schutz (PTC) aktiv.

Même dans le cas de la configuration Bi-Amp reste protection thermique active (PTC).

- 1) Assicurarsi che i cavi SPEAK-ON di collegamento siano scollegati dal DVX P215.

Verify that the SPEAK-ON connection cables are disconnected from DVX P215.

Achten Sie darauf, die Kabel SPEAK-ON-Verbindung aus der DVX P215 getrennt.

Assurez-vous que les câbles SPEAK-ON connexion sont déconnectés de la DVX P215.

- 2) Per togliere il pannello dal diffusore rimuovere **SOLO** le viti indicate con le frecce.

To remove the panel from speaker box, remove **ONLY** the screws indicated from arrows

Um der Deckel aus dem Lautsprecher zu entfernen **NUR** die mit Pfeilen markierten Schrauben lösen.

Pour retirer le panneau du haut-parleur ne retirer **SEULEMENT** les vis indiquées par des flèches.

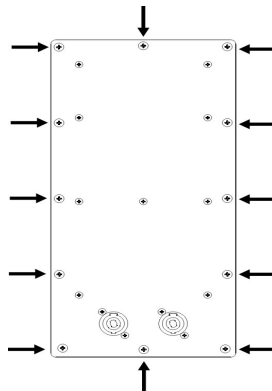
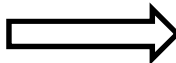
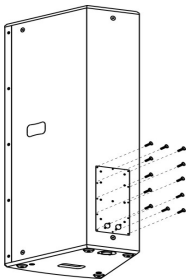

- 2) Togliere il connettore cavi dalla posizione "FILTER" e inserirlo nella posizione "BI-AMP".
 To remove the cable connector from "FILTER" position and connect it in "BI-AMP" position.
 Entfernen Sie die Anschlusskabel von der "FILTER" Stellung und stecken Sie sie in der "BI-AMP" Stellung.
 Retirez les câbles de connexion de la "FILTER" et ajoutez dans la "BI-AMP".

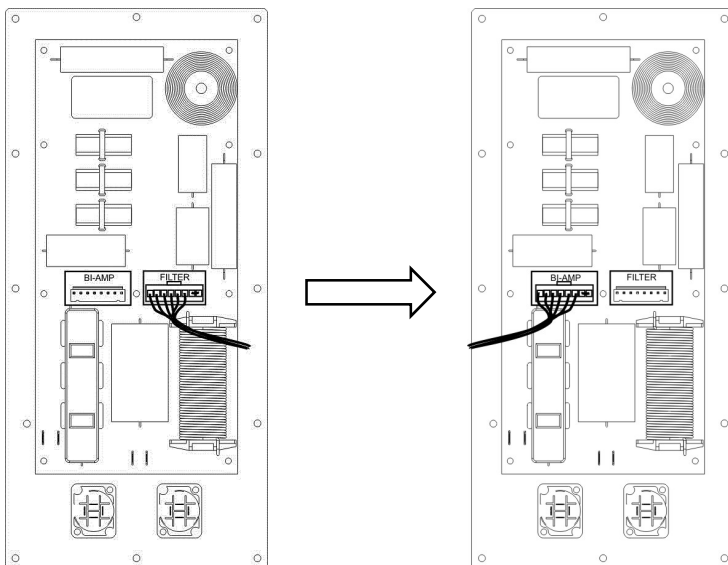

**FULL RANGE setting
(default factory setting)**

BI – AMP setting

- 3) Riposizionare il pannello sul diffusore e fissare con le viti precedentemente tolte .
 To replace the panel on the speaker and fix with screws .
 Setzen Sie den Deckel auf den Lautsprecher zurück und mit Schrauben anschrauben.
 Remettre le couvercle sur le haut-parleur et fixer avec des vis.

Cavo di collegamento DVX P215 BI-AMP
 Connection cable DVX P215 BI-AMP
 Kabelanschluss DVX P215 BI-AMP
 Câble de raccordement DVX P215 BI-AMP

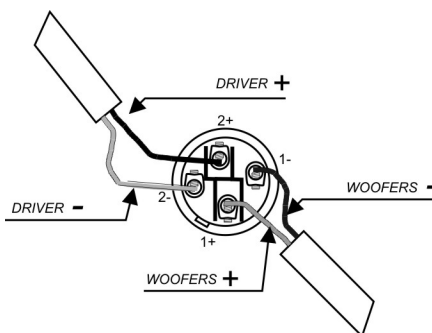



A.E.B. Industriale Srl
Via Brodolini, 8
Località Crespellano
40053 VALSAMOGGIA
BOLOGNA (ITALIA)

Tel +39 051 969870

Fax +39 051 969725

www.dbtechnologies.com
info@dbtechnologies-aeb.com