

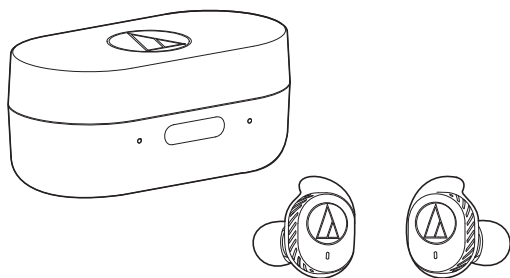

ATH-SPORT7TW

User Manual
Wireless Headphones



Introduction

Thank you for purchasing this Audio-Technica product.

Before using the product, please read through the Quick Start Guide and Caution Guide, as well as this user manual when necessary, to ensure that you use the product correctly.

Safety precautions

Although this product was designed to be used safely, failing to use it correctly may result in an accident. To ensure safety, observe all warnings and cautions while using the product.

Cautions for the headphones

- Do not use the product near medical equipment. Radio waves may affect cardiac pacemakers and medical electronic equipment. Do not use the product inside medical facilities.
- When using the product in aircraft, follow airline instructions.
- Do not use the product near automatic control devices such as automatic doors and fire alarms. Radio waves may affect electronic equipment and cause accidents due to malfunction.
- Do not disassemble, modify or attempt to repair the product to avoid electric shock, malfunction or fire.
- Do not subject the product to strong impact to avoid electric shock, malfunction or fire.
- Disconnect the product from a device if the product begins to malfunction, producing smoke, odor, heat, unwanted noise or showing other signs of damage. In such a case, contact your local Audio-Technica dealer.
- Do not put foreign matter such as combustible materials, metal, or liquid in the product.
- Do not cover the product with a cloth to avoid fire or injury by overheating.
- Follow applicable laws regarding mobile phone and headphone use if using headphones while driving.
- Do not use the product in places where the inability to hear ambient sound presents a serious risk (such as at railroad crossings, train stations, and construction sites).
- The product effectively shields external sound, so you may not hear sound around you clearly while wearing the product. Adjust the volume to a level where you can still hear background sound and monitor the area around you while listening to music.
- Store the product out of the reach of small children.
- To prevent damage to your hearing, do not raise the volume too high. Listening to loud sound for an extended period may cause temporary or permanent hearing loss.
- Discontinue use if skin irritation results from direct contact with the product.
- If you begin to feel unwell while using the product, discontinue use immediately.
- When removing the product from your ears, check to make sure the eartips are still attached to the main unit. If the eartips become lodged in your ears and you are unable to remove them, consult a physician at once.
- If you develop an itch from wearing the product, discontinue use.

Cautions for charging case

- Do not disassemble, modify or attempt to repair the product to avoid electric shock, malfunction or fire.
- Do not subject the product to strong impact to avoid electric shock, malfunction or fire.
- Do not handle the product with wet hands to avoid electric shock or injury.
- Disconnect the product from a device if the product begins to malfunction, producing smoke, odor, heat, unwanted noise or showing other signs of damage. In such a case, contact your local Audio-Technica dealer.
- Do not allow the product to get wet to avoid electric shock or malfunction.
- Do not put foreign matter such as combustible materials, metal, or liquid in the product.
- Do not cover the product with a cloth to avoid fire or injury by overheating.
- When charging, make sure to use the included USB charging cable.
- Do not charge with devices that have quick-charge functionality (with a voltage of 5 V or more). Doing so may cause the product to malfunction.
- Do not store the product in direct sunlight, near heating devices, or in hot, humid, or dusty places because such storage could cause malfunction or defect.
- Do not put the product close to fire because that could cause deformation or malfunction.
- Do not use benzene, paint thinners and electrical contact cleaner, etc. because use of such material could cause deformation or malfunction.

Safety precautions

Cautions for rechargeable battery

The headphones are equipped with a rechargeable battery (lithium ion battery).

The charging case is equipped with a rechargeable battery (lithium polymer battery).

- If battery fluid gets into eyes, do not rub them. Rinse thoroughly with clean water such as tap water and consult a doctor immediately.
- If battery fluid leaks, do not touch fluid with bare hands. If fluid remains inside the product, it may cause malfunction. If battery fluid leaks, contact your local Audio-Technica dealer.
 - If fluid gets in your mouth, gargle thoroughly with clean water such as tap water and consult a doctor immediately.
 - If your skin or clothing comes in contact with fluid, immediately wash the affected skin or clothing with water. If you experience skin irritation, consult a doctor.
- To avoid leakage, generation of heat or explosion:
 - Never heat, disassemble or modify the battery, nor dispose of it in a fire.
 - Do not attempt to pierce with a nail, hit with a hammer or step on the battery.
 - Do not drop the product or subject it to strong impact.
 - Do not get the battery wet.
- Do not use, leave or store the battery in the following places:
 - Area exposed to direct sunlight or high temperatures and humidity
 - Inside of a car under the blazing sun
 - Near heat sources such as heat registers
- Charge only with the included USB cable to avoid malfunction or fire.
- The internal rechargeable battery of this product cannot be replaced by the user. The battery may have reached the end of its service life if the usage time becomes significantly shorter even after the battery has been fully charged. If this is the case, the battery needs to be repaired. Contact your local Audio-Technica dealer for repair details.
- When the product is disposed of, the built-in rechargeable battery needs to be discarded properly. Contact your local Audio-Technica dealer to learn how to properly dispose of the battery.

For customers in the USA

FCC Notice

Warning

This device complies with Part 15 of the FCC Rules.

Operation is subject to the following two conditions: (1) This device may not cause harmful interference, and (2) this device must accept any interference received, including interference that may cause undesired operation.

Caution

You are cautioned that any changes or modifications not expressly approved in this manual could void your authority to operate this equipment.

Note: This equipment has been tested and found to comply with the limits for a Class B digital device, pursuant to part 15 of the FCC Rules. These limits are designed to provide reasonable protection against harmful interference in a residential installation. This equipment generates, uses and can radiate radio frequency energy and, if not installed and used in accordance with the instructions, may cause harmful interference to radio communications. However, there is no guarantee that interference will not occur in a particular installation. If this equipment does cause harmful interference to radio or television reception, which can be determined by turning the equipment off and on, the user is encouraged to try to correct the interference by one or more of the following measures:

- Reorient or relocate the receiving antenna.
- Increase the separation between the equipment and receiver.
- Connect the equipment to an outlet on a circuit different from that to which the receiver is connected.
- Consult the dealer or an experienced radio/TV technician for help.

RF Exposure Statement

This transmitter must not be co-located or operated in conjunction with any other antenna or transmitter used in other systems. This device complies with FCC radiation exposure limits set forth for an uncontrolled environment and meets the FCC radio frequency (RF) Exposure Guidelines. This equipment has very low levels of RF energy that is deemed to comply without testing of specific absorption rate (SAR).

For customers in Canada

IC statement

CAN ICES-3 (B)/NMB-3(B)

This device complies with Industry Canada's licence-exempt RSSs. Operation is subject to the following two conditions: (1) This device may not cause interference; and (2) This device must accept any interference, including interference that may cause undesired operation of the device.

Under Industry Canada regulations, this radio transmitter may only operate using an antenna of a type and maximum (or lesser) gain approved for the transmitter by Industry Canada. To reduce potential radio interference to other users, the antenna type and its gain should be so chosen that the equivalent isotropically radiated power (e.i.r.p.) is not more than that necessary for successful communication.

This device complies with RSS-102 radiation exposure limits set forth for an uncontrolled environment.

Notes on use

- Be sure to read the connected device's user manual before use.
- Audio-Technica will not be liable in any way for any loss of data in the unlikely event that such losses should occur while using the product.
- On public transportation or in other public places, keep the volume low so as not to disturb other people.
- Minimize the volume on your device before connecting the product.
- When using the product in a dry environment, you may feel a tingling sensation in your ears. This is caused by static electricity accumulated on your body, not by product malfunction.
- Do not subject the product to strong impact.
- Do not store the product in direct sunlight, near heating devices, or in hot, humid, or dusty places.
- When the product is used for a long time, the product may become discolored due to ultraviolet light (especially direct sunlight) and wear.
- Make sure to hold the plug when connecting and disconnecting the USB charging cable. The USB charging cable may become severed or an accident may occur if you pull on the cable itself.
- When you are not using the USB charging cable, disconnect it from the charging case.
- If the charging case is placed in a bag while the USB charging cable is still connected, the USB charging cable may become caught, severed, or broken.
- When you are not using the product, store it in the included charging case.
- This product can be used to talk on the phone only when using a mobile telephone network. Support for telephony apps that use a mobile data network is not guaranteed.
- If you use the product near an electronic device or transmitter (such as a mobile phone), unwanted noise may be heard. In this case, move the product away from the electronic device or transmitter.
- If you use the product near a TV or radio antenna, noise may be seen or heard in the television or radio signal. In this case, move the product away from the TV or radio antenna.
- To protect the built-in rechargeable battery, charge it at least once every 6 months. If too much time passes between charges, the life of the rechargeable battery may be reduced, or the rechargeable battery may no longer be able to be charged.
- When charging the product, keep it away from direct sunlight and charge in a well-ventilated place. The battery may deteriorate and shorten the continuous usage time, or the battery may no longer be able to be charged.
- The headphones are waterproof, but the charging case is not. Do not charge the headphones when they are wet. Doing so may cause the product to malfunction.
- If the product will not be used for an extended period of time, store it in a well-ventilated place free from high temperatures and humidity.
- Do not leave the product inside of a car under the blazing sun. Doing so may result in malfunction.
- The hear-through mode of the product allows you to hear the sounds around you as picked up by the built-in microphone. Depending on the volume of the music being played back, the surrounding sounds may be difficult to hear. In this case, turn down the volume of the music.
- Depending on your surroundings, the surrounding sounds may be difficult to hear even when using the product's hear-through mode.
Do not use the product in places that are dangerous if you cannot hear the surrounding sounds, such as places with heavy traffic.
- Operate the touch sensor with one finger. Operating with a sharp-tipped object, such as a ballpoint pen or pencil, may result not only in incorrect operation, but also damage to the touch sensor.
- Do not touch the touch sensor with your fingertips. Doing so may cause your fingernail to break.
- If the product does not operate at all or as intended when touched, check to make sure that your other fingers, parts of your hand, or clothing hems are not in contact when touching. Also, the product may not operate correctly if you are wearing gloves or if your fingertips are too dry.
- The product may not operate correctly if the touch sensor is dirty from sweat.
Remove the dirt before operating the product.

Waterproof performance

- The waterproof performance of the product is designed to prevent liquid, such as sweat or running water, from entering the product (equivalent to IPX5).
- Although the product has waterproof capabilities equivalent to IPX5, the part where the sound comes from is not water-resistant, and allowing water to enter this part may hinder its ability to reproduce sound.
- The product is not completely waterproof. Do not intentionally submerge or use it in water. Also, do not expose it to liquids other than sweat and water (such as soapy water).
- If dirt such as sweat or sand adheres to the product, wash it with normal temperature (10 to 35°C) fresh water or gentle-flowing tap water instead of soapy water. Do not directly expose the "part where the sound comes from" (not water-resistant) to water. For details, refer to "Cleaning" in the Operating Instructions, which can be downloaded from our homepage, to remove the dirt.
- The product is not designed to be damp-proof. Do not use the product in environments with high humidity (such as bathrooms or saunas). Doing so may result in malfunction.

For a more comfortable Bluetooth® communication experience

The effective communication range of this product varies depending on obstructions and radio wave conditions. For a more enjoyable experience, please use the product as close as possible to the Bluetooth device. To minimize noise and sound disruptions, avoid placing your body or other obstacles between the product's antenna (R side) and the Bluetooth device.

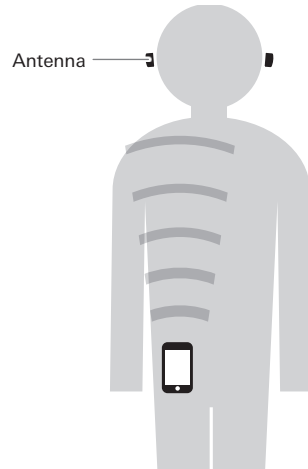

Part names and functions

Headphones

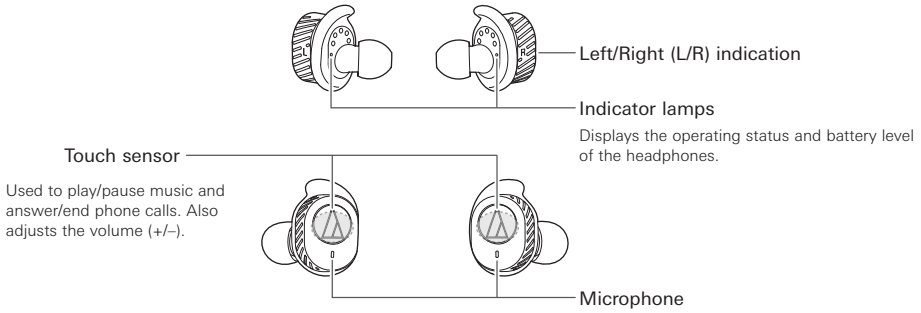

Charging case

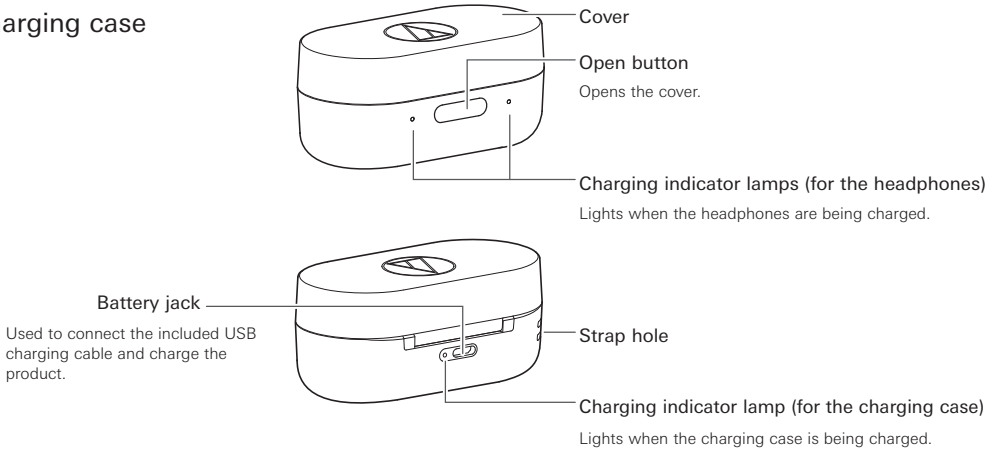

■ Accessories



- USB charging cable (30 cm (1') long)



- Eartips*¹ (XS, S, M, L)

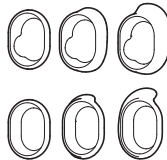

- Ear fins*¹ (XS, S, M, L)



- COMPLY™ foam eartips*² (M)

*1 At the time of purchase, M-size eartips/ear fins are attached to the main unit.

*2 For details on usage, maintenance, and replacement of COMPLY™ foam eartips, see "COMPLY™ Foam Eartips", which you can download from our website.



Charging the battery

Charging the headphones and charging case

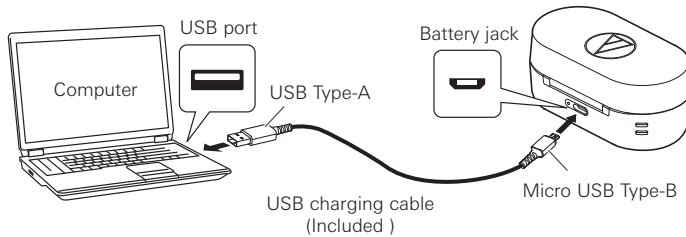
- Fully charge the battery when using for the first time.
 - If the rechargeable battery power is running low, the product will beep through the headphones, and the indicator lamps of the headphones will flash in red. When these beeps sound, charge the battery.
 - It takes approximately two hours to fully charge the headphones, and approximately three hours to fully charge the charging case. (This time may vary depending on usage conditions.)
1. Connect the included USB charging cable (micro USB Type-B side) to the battery jack of the charging case.
 - The included USB charging cable is designed for exclusive use with the product. Do not use any other USB charging cable.
 - When inserting the USB charging cable into the USB port or battery jack, check that the connector is facing in the correct direction before inserting it directly (horizontally).
 2. Connect the included USB charging cable (USB Type-A side) to the computer to start charging the charging case.



- During charging, the charging indicator lamp (for the charging case) lights on the rear of the charging case as follows:

| Charging state of charging case | Charging indicator lamp | |
|---------------------------------|---|--------------|
| | Red | Blue |
| Charging |  | Lit red |
| Charging complete |  | Lit blue |
| Charging failure |  | Flashing red |

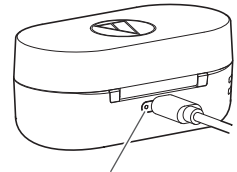

Charging the battery

3. Place the headphones in the charging case.

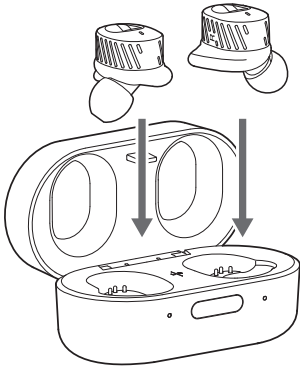

4. Close the charging case cover, and start charging the headphones.

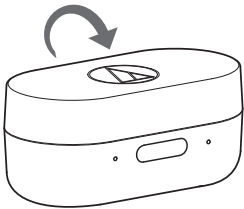

• During charging, the two charging indicator lamps (for the headphones) light at the front of the charging case as follows: *1

| Charging state of headphones | Charging indicator lamps ● Red ● Blue | |
|--|--|---|
| | Light pattern | |
| Charging | ● | Lit red |
| Charging complete | ● | Lit blue (It turns off after 3 minutes.) |
| Battery level of the charging case is low. | | Red lamp flashes slowly.*2 |
| Charging failure | | Red lamp flashes quickly. |

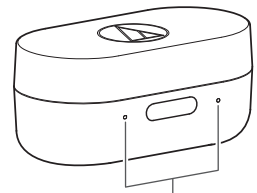

Charging indicator lamps (for the headphones)

*1 The two charging indicator lamps show the charging state of the left and right headphones.

*2 It lights if the USB charging cable is not connected.

5. When charging is complete, disconnect the USB charging cable (USB Type-A side) from the computer.

6. Disconnect the USB charging cable (micro USB Type-B side) from the battery jack on the charging case.

Charging the battery

Charging headphones in the charging case

A rechargeable battery is built into the charging case. If you have charged the charging case, you can charge the headphones without using the USB charging cable.

- If the rechargeable battery power is running low, the product will beep through the headphones, and the indicator lamps of the headphones will flash in red. When these beeps sound, charge the battery.

1. Place the headphones in the charging case.
2. Close the charging case cover, and start charging.
 - During charging, the two charging indicator lamps (for the headphones) light at the front of the charging case. *

* For indicator lighting, see "Charging the headphones and charging case" (p.6). Also, if the charging case is fully discharged, the charging indicator lamps do not light even when the headphones are placed in the charging case.

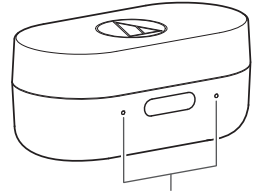

Charging indicator lamps
(for the headphones)

Connecting via Bluetooth wireless technology

To connect the product to a Bluetooth device, the product needs to pair (register) with the device.

Pairing a Bluetooth device

- Read the user manual for the Bluetooth device.
 - Place the Bluetooth device within 1 m (3.3') of the product to perform pairing correctly.
 - To confirm the progress of the pairing process, wear the product while performing this procedure and listen for the confirmation tone.
1. Remove this product from the charging case.
 - The indicator lamp on the right will quickly flash in blue.
 2. Use your Bluetooth device to begin the pairing process and search for the product. When your Bluetooth device finds the product, "ATH-SPORT7TW" will be displayed on the device.
 - For information about using your Bluetooth device, refer to the device's user manual.
 - This product may be displayed as "ATH-SPORT7TW" or "BLE_ATH-SPORT7TW". Select whichever name is displayed. If both names are displayed, select "ATH-SPORT7TW".
 3. Select "ATH-SPORT7TW" to pair the product and your Bluetooth device.
 - Some devices may ask for a passkey. In this case, enter "0000". The passkey may also be called a passcode, PIN code, PIN number, or password.
 - The product sounds a confirmation tone when pairing is complete.



About pairing

When connecting a new Bluetooth device, you need to pair it with the product. Once the Bluetooth device and the product are paired, you do not need to pair them again.

However, in the following cases, pairing is necessary even if the Bluetooth devices have been paired previously.

- If the product is deleted from the Bluetooth device's connection history.
- If the product is sent out for repair.
- When eight or more devices are paired. (This product can save the pairing information of up to seven devices. When you pair with a new device after pairing with seven devices, pairing information for the device with the oldest connection date will be overwritten by the information for the new device.)

Using the product

The product can use Bluetooth wireless technology to connect to your device and play music, receive phone calls, etc. Use the product for whichever of these purposes suits your needs.

Note that Audio-Technica cannot guarantee the operation of displays, such as the battery level display, or applications via Bluetooth devices.

Power ON/OFF switching

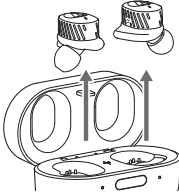
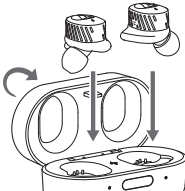
| Power supply | | Operation |
|--------------|---|---|
| ON | Remove this product from the charging case. |  |
| OFF | Place this product in the charging case. |  |

Wearing the product

Insert the headphone marked "L" (LEFT) into the left ear, and the headphone marked "R" (RIGHT) into the right ear as shown in the figure.

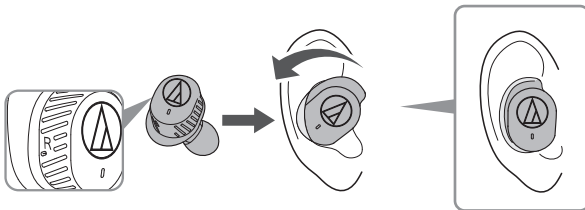

Unlocking

When you take the headphones out of your ears, the touch sensor is locked to prevent erroneous operations. After pairing, when you touch the right (R) sensor once, the unlock tone sounds and you can use the touch sensor.



Using the product

Listening to music

- To connect for the first time, pair the product and your device via Bluetooth wireless technology. If you have already paired the product and your Bluetooth device, turn on the Bluetooth device's Bluetooth connection before turning on the product.
- Use your Bluetooth device to start playback, referring to the device's user manual as necessary.

Touch sensor (R (Right) side)

| | | |
|----------------------------|----------------------------|---|
| Touch | Play/pause | Plays or pauses music and video playback. |
| Touch (2 times) | Skip forward | Plays the next track. |
| Touch (3 times) | Skip back | Plays the previous track. |
| Long touch (Approx. 2 sec) | Speech recognition feature | Depending on the connected device, activates the device's speech recognition feature (such as Siri for compatible iOS devices). |

- Some controls may not be available for music and video playback on some smartphones.

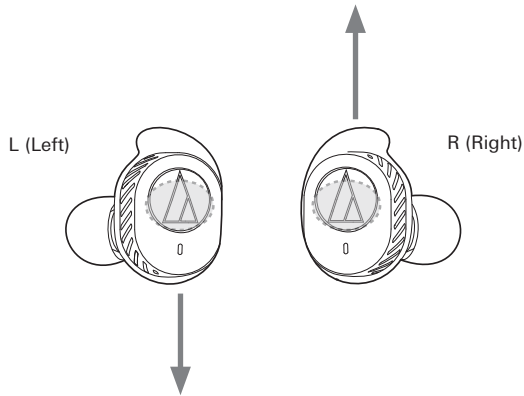

Touch sensor (L (Left) side)

| | | |
|-----------------|-------------|----------------------------------|
| Touch | Volume up | Increases the volume by 1 level. |
| Touch (2 times) | Volume down | Decreases the volume by 1 level. |

- The volume control of some devices may not work well with the product.

Using the product

Using the Hear-Through mode

- In the Hear-Through mode, you can listen to the surrounding sound without taking the headphones off, via the built-in microphones.
- Occasionally it may be difficult to hear surrounding sound depending on the volume of the music, etc. that you are playing. In such a case, turn down the volume of the music, etc.
- Even when you use the Hear-Through mode of this product, the surrounding sound may be difficult to hear depending on the surrounding situation, etc. Do not use this product in locations where it may be dangerous if you cannot hear surrounding sound, such as places with heavy traffic, etc.
- When the Hear-Through mode is turned ON, the volume of the music, etc. is automatically reduced in order to enhance the surrounding sound.
- The Hear-Through mode may not be activated depending on the environment the product is being used in. In such a case, place the headphones in the charging case, and then take them out.
- When the Hear-Through mode is turned ON, do not cover the microphone part with your hand. If you do so, a loud sound (howling) will be emitted, and it may adversely affect your hearing ability.

To turn the Hear-Through mode ON, long touch (approx. 2 seconds) the touch sensor on the L (Left) headphone.

- To turn the Hear-Through mode OFF, long touch (approx. 2 seconds) the touch sensor again.
- A confirmation beep will sound each time you turn this mode ON or OFF.

L (Left)

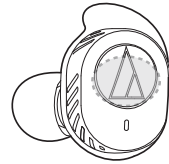

Using the product

Talking on the phone

- If your Bluetooth device supports telephone features, you can use the product to talk on the phone.
- When your Bluetooth device receives a phone call, a ring tone will be heard through the R (Right) headphone.
- If a call is received while you are listening to music, music playback is paused. When you finish the call, music playback resumes. *1

| When | Function | Operation |
|------------------|---|-------------------|
| Receiving a call | Touch the sensor on the R (Right) headphone. | Answers the call. |
| | Long touch (approx. 2 seconds) the sensor on the R (Right) headphone. | Rejects the call. |
| Talking*2 *3 | Long touch (approx. 2 seconds) the sensor on the R (Right) headphone. | Ends the call. |

*1 Depending on your Bluetooth device, music playback may not resume.

*2 Adjust the volume of a call on the Bluetooth device side.

*3 You can hear the call sound only through the R (Right) headphone.

- The phone call controls explained above may not be available on some smartphones.

Auto power off function

The product automatically turns off after 5 minutes of not being connected to a device.

Reset function

If the product does not work, or other malfunctions occur, place the headphones in the charging case while referring to "Charging the battery"(p.6) and connect the USB charging cable that is carrying power, and then reset the product.

Disconnecting and then reconnecting the USB charging cable should resolve any problem you are experiencing. If the problem persists, please contact your local Audio-Technica dealer.

Resetting does not change any of your settings (pairing information setting, etc.).

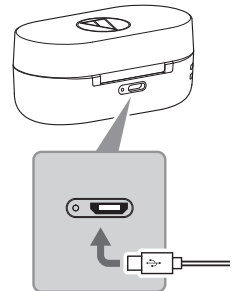

Cleaning

Get into the habit of regularly cleaning the product to ensure that it will last for a long time. Do not use alcohol, paint thinners, or other solvents for cleaning purposes.

Headphones

- Remove the eartips when cleaning the headphones.
- If any dirt such as sweat or sand has become attached to the headphones, rinse them with fresh water at normal temperature (10 to 35°C (50 to 95 °F)) or under a gentle flow of tap water. Do not use soapy water.
- Wash the outside of the headphones. Do not spray water directly onto the sound reproduction part or the microphone (non-water resistant area).
- Do not wash with a brush or sponge, but wash by hand.
- Although headphones are waterproof equivalent to IPX 5, the sound reproduction parts and the microphones are not water resistant. If any water enters the interior of the headphones, no sound will be reproduced, or sounds may be difficult to hear.
- In particular, it is likely that natural oils from your skin will collect on the eartip attachment parts (see figure below). If these areas are not cleaned, the eartips can become detached. Clean them regularly. Do not touch the areas where sound is produced as they are delicate. Doing so may result in malfunction.

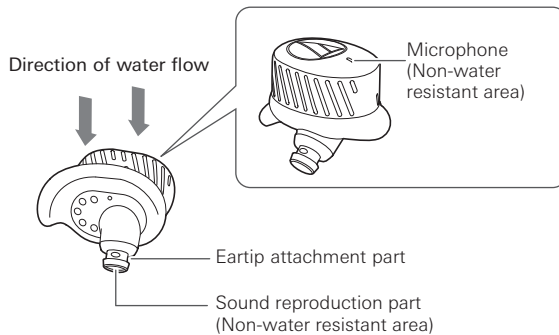

After washing, wipe off the product according to the following procedure.

1. Wipe any surface moisture thoroughly with a dry, clean, and soft cloth.
2. Hold the headphone firmly, and shake it approximately 20 times until no more water droplets come off.
 - If any moisture remains in the areas where sound is produced and in the microphone, sound may not be produced. In such a case, place a dry cloth on a flat surface as shown in the figure on the right, and with the sound reproduction part and the microphone respectively facing the bottom, shake the headphone approximately 20 times.
3. Wipe off any water that remains in the gap between the sound reproduction part and the microphone by gently pressing the headphones against a dry, clean and soft cloth.
4. Dry the product thoroughly in a well-ventilated shady location.
 - Do not apply hot air such as by using a dryer.
 - Do not wipe off any water in the gap with a cotton swab, etc.

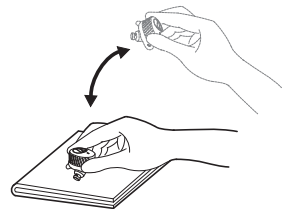

Cleaning

Charging case, USB charging cable, and eartips

- Wipe any dirt off the charging case with a dry cloth.
 - Immediately wipe off any moisture such as sweat that has splashed onto the charging case battery jack, the charging terminals, etc. Failure to do so may result in a malfunction due to corrosion.
 - If the USB charging cable is dirty, wipe the cable with a dry cloth immediately after use. Failure to clean the cable may cause it to deteriorate and harden over time, resulting in malfunction.
 - If the USB terminal of the charging cable is dirty, wipe it off with a dry cloth.
 - Clean the eartips by removing them from the headphones and manually cleaning them with a diluted mild detergent. After cleaning, dry before using again.
-
- If the product will not be used for an extended period of time, store it in a well-ventilated place free from high temperatures and humidity.

Eartips

Eartip size

The product includes silicone eartips in 4 sizes (XS, S, M, and L). At the time of purchase, the M-size silicone eartips are attached.

To ensure the best sound quality, select the eartip size that is best suited for you, and adjust the eartips inside your ears for a snug fit. It may be difficult to hear bass sounds if the eartips do not fit snugly in your ears.

Replacing the eartips

Remove the old eartip and attach the new eartip by pushing it onto the headphone at an angle (see figure).

Push firmly on the eartip so that the inside of the eartip expands, and push the eartip onto the post as far as it will go.

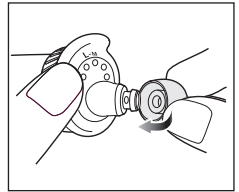

- Periodically remove and clean the eartips as they become dirty easily. Using dirty eartips may cause the headphones themselves to become dirty, resulting in deteriorated sound quality.
- Eartips are consumable parts that degrade through storage and use. If the eartips are loose and easily removed or if they appear to have degraded, purchase replacements.
- When reattaching eartips that were previously removed, be sure to check that they are securely attached. Injury or illness may occur if the eartips become detached and are left inside the ear.

Ear fins

Ear fin sizes

The product includes silicone ear fins in four sizes (XS, S, M, and L). At the time of purchase, M-size silicone ear fins are attached.

Select ear fins that fit your ear, and install them.

Replacing the ear fins

- Remove the ear fin by pulling it off the rear of the unit and pushing it forward over the eartip. Then fit the new ear fin on the headphone, hooking the notches in the ear fin onto the nubs on the headphone's outer rim.
- Confirm that you are installing the left and right ear fins to the correct headphone.

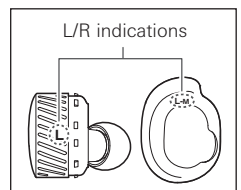
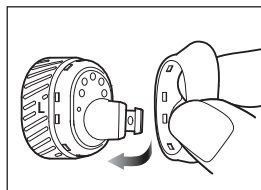

Troubleshooting

| Problem | Solution |
|---|---|
| Power is not supplied | <ul style="list-style-type: none">• Charge the product. |
| Unable to pair. | <ul style="list-style-type: none">• Visit our website for information on compatible models. Confirm that the Bluetooth device communicates using Ver. 2.1+EDR or higher.• Place the product and the Bluetooth device within 1 m (3.3') of each other.• Set the profiles for the Bluetooth device. For procedures on how to set profiles, refer to the Bluetooth device's user manual.• Remove the pairing information for the Bluetooth device then pair the product with this device again.• While searching, this product may be displayed as "ATH-SPORT7TW" or "BLE_ATH-SPORT7TW" on your Bluetooth device. Select whichever name is displayed. If both names are displayed, select "ATH-SPORT7TW". |
| No sound is heard / Sound is faint. | <ul style="list-style-type: none">• Turn on the power of the product and the Bluetooth device.• Turn up the volume.• Make sure that this product and Bluetooth device are connected by the A2DP (or an audio device).• Disable pairing for this product and the Bluetooth device, then pair the product with this device again.• Move away from obstacles between the product and the Bluetooth device, such as people, metal or walls, and place the product and device closer together.• Switch the sound output of the Bluetooth device to this product. |
| The L (Left) and R (Right) are not connected (no sound is output from the L (Left) side). | <ul style="list-style-type: none">• Check whether the battery is dead.• Place the headphones in the charging case and close the cover. Then, take the headphones out again.• If the error recurs after you attempted the procedure described above, the connection between L (Left) and R (Right) may be broken. Follow the steps below to manually connect them.• While the headphones are not connected to a Bluetooth device and the indicator lamp is flashing rapidly in blue, touch both the L (Left) and R (Right) touch sensors twice. The L (Left) and R (Right) indicator lamps change to red. After a while, the L (Left) indicator lamp flashes slowly in blue, which indicates that the L (Left) and R (Right) are connected. |

Troubleshooting

| Problem | Solution |
|---|--|
| Sound is distorted / Noise is heard / Sound cuts out. | <ul style="list-style-type: none">• Turn down the volume.• Keep this product away from devices that emit radio waves such as microwaves and wireless routers.• Keep this product away from TVs, radios, and devices with built-in tuners. These devices can also be affected by the product.• Turn off the equalizer settings of the Bluetooth device.• Remove obstacles between the product and the Bluetooth device and place them closer together. For details, please refer to "For a more comfortable Bluetooth communication experience" (p.4).• The connection status may be improved by changing the connection codec to SBC. The product can be adjusted with our smartphone apps. |
| Cannot hear the voice of the caller / Voice of the caller is too quiet. | <ul style="list-style-type: none">• Turn on the power of the product and the Bluetooth device.• Turn up the volume.• Make sure that this product and Bluetooth device are connected by the HFP/ HSP (or call connection).• Disable pairing for this product and the Bluetooth device, then pair the product with this device again.• Switch the sound output of the Bluetooth device to this product. |
| The charging case cannot be charged. | <ul style="list-style-type: none">• Securely connect the included USB charging cable and charge the product. |
| Headphones cannot be charged. | <ul style="list-style-type: none">• Charge the charging case.• Wipe dirt off the charging terminal with a dry cloth. |
| The touch sensor cannot be operated. | <ul style="list-style-type: none">• When you take the headphones out of your ears, unlock them first. |
| The Hear-Through mode cannot be activated. | <ul style="list-style-type: none">• Place the headphones in the charging case and close the cover. Then, take the headphones out again. |
| | <ul style="list-style-type: none">• Since each Bluetooth device requires different operations, please refer to the relevant Bluetooth device's user manual.• If the problem still remains, reset the product. To reset the product, refer to "Reset function" (p.13) under "Using the product". |

Specifications

Headphones

| | |
|--------------------|-----------------|
| Type | Dynamic |
| Driver | 5.8 mm |
| Sensitivity | 91 dB/mW |
| Frequency response | 20 to 25,000 Hz |
| Impedance | 14 ohms |

Microphone

| | |
|--------------------|---------------------------|
| Type | MEMS |
| Polar pattern | Omnidirectional |
| Sensitivity | -42 dB (1 V/Pa, at 1 kHz) |
| Frequency response | 100 to 8,000 Hz |

Communication specifications

| | |
|-------------------------------------|------------------------------------|
| Communication system | Bluetooth version 5.0 |
| RF output | 4.74 mW EIRP |
| Maximum communication range | Line of sight - approx. 10 m (33') |
| Frequency band | 2.402 GHz to 2.480 GHz |
| Modulation method | FHSS |
| Compatible Bluetooth profiles | A2DP, AVRCP, HFP, HSP |
| Support codec | AAC, SBC |
| Supported content protection method | SCMS-T |
| Transmission band | 20 to 20,000 Hz |

Other

| | |
|-----------------------|---|
| Power supply | Headphones: DC 3.7 V lithium ion battery/ Charging case: DC 3.7 V lithium polymer battery |
| Charging time | Headphones: Approx. 2 hours* / Charging case: Approx. 3 hours* |
| Operating time | Continuous transmission time (music playback): Max. approx. 3.5 hours* (headphones), Max. approx. 17.5 hours* (if charging case is used in combination) |
| Weight | Headphones: Approx. 6.4 g (0.2 oz) (L side), approx. 6.4 g (0.2 oz) (R side) / Charging case: Approx. 64 g (2.2 oz) |
| Operating temperature | 5°C to 40°C (41°F to 104°F) |
| Accessories | <ul style="list-style-type: none">• USB charging cable (30 cm (12")), USB Type-A / Micro USB Type-B)• Eartips (XS, S, M, L)• COMPLY™ foam eartip (M)• Ear fins (XS, S, M, L) |
| Sold separately | <ul style="list-style-type: none">• Eartips |

* The above figures depend on operating conditions.

For product improvement, the product is subject to modification without notice.

- The Bluetooth® word mark and logos are owned by Bluetooth SIG, Inc. and any use of such marks by Audio-Technica Corporation is under license. All other trademarks are property of their respective owners.
- "AAC" logo is a trademark of Dolby Laboratories.
- Apple and the Apple logo are trademarks of Apple Inc., registered in the U.S. and other countries.
- App Store is a service mark of Apple Inc.
- Google Play and the Google Play logo are trademarks of Google LLC.

Audio-Technica Corporation

2-46-1 Nishi-naruse, Machida, Tokyo 194-8666, Japan

www.audio-technica.com

©2018 Audio-Technica Corporation

Global Support Contact: www.at-globalsupport.com

132900730-02-01 ver.1 2018.11.01