



# ATH-G1WL

User Manual  
Wireless Gaming Headset



# Introduction

Thank you for purchasing this Audio-Technica product.

Before using the product, please read through the Quick Start Guide and Caution Guide, as well as this user manual when necessary, to ensure that you will use the product correctly.

## Safety precautions

Although this product was designed to be used safely, failing to use it correctly may result in an accident. To ensure safety, observe all warnings and cautions while using the product.

### Cautions for the product

- Do not use the product near medical equipment. Radio waves may affect cardiac pacemakers and medical electronic equipment. Do not use the product inside medical facilities.
- When using the product in aircraft, follow airline instructions.
- Do not use the product near automatic control devices such as automatic doors and fire alarms. Radio waves may affect electronic equipment and cause accidents due to malfunction.
- Do not disassemble, modify or attempt to repair the product to avoid electric shock, malfunction or fire.
- Do not subject the product to strong impact to avoid electric shock, malfunction or fire.
- Do not handle the product with wet hands to avoid electric shock or injury.
- Disconnect the product from a device if the product begins to malfunction, producing smoke, odor, heat, unwanted noise or showing other signs of damage. In such a case, contact your local Audio-Technica dealer.
- Do not allow the product to get wet to avoid electric shock or malfunction.
- Do not put foreign matter such as combustible materials, metal, or liquid in the product.
- Do not cover the product with a cloth to avoid fire or injury by overheating.
- Follow applicable laws regarding mobile phone and headphone use if using headphones while driving.
- Do not use the product in places where the inability to hear ambient sound presents a serious risk (such as at railroad crossings, train stations, and construction sites).
- When charging, make sure to use the included USB charging cable.
- Do not charge with devices that have quick-charge functionality (with a voltage of 5 V or more). Doing so may cause the product to malfunction.
- To prevent damage to your hearing, do not raise the volume too high. Listening to loud sound for an extended period may cause temporary or permanent hearing loss.
- Discontinue use if skin irritation results from direct contact with the product.
- Do not catch your fingers or other body parts between the housing and the arm or inside the joints.

# Safety precautions

## Cautions for rechargeable battery

The product is equipped with a rechargeable battery (lithium polymer battery).

- If battery fluid gets into eyes, do not rub them. Rinse thoroughly with clean water such as tap water and consult a doctor immediately.
- If battery fluid leaks, do not touch fluid with bare hands. If fluid remains inside the product, it may cause malfunction. If battery fluid leaks, contact your local Audio-Technica dealer.
  - If fluid gets in your mouth, gargle thoroughly with clean water such as tap water and consult a doctor immediately.
  - If your skin or clothing comes in contact with fluid, immediately wash the affected skin or clothing with water. If you experience skin irritation, consult a doctor.
- To avoid leakage, generation of heat or explosion:
  - Never heat, disassemble or modify the battery, nor dispose of it in a fire.
  - Do not attempt to pierce with a nail, hit with a hammer or step on the battery.
  - Do not drop the product or subject it to strong impact.
  - Do not get the battery wet.
- Do not use, leave or store the battery in the following places:
  - Area exposed to direct sunlight or high temperatures and humidity
  - Inside of a car under the blazing sun
  - Near heat sources such as heat registers
- Charge only with the included USB cable to avoid malfunction or fire.
- The internal rechargeable battery of this product cannot be replaced by the user. The battery may have reached the end of its service life if the usage time becomes significantly shorter even after the battery has been fully charged. If this is the case, the battery needs to be repaired. Contact your local Audio-Technica dealer for repair details.
- When the product is disposed of, the built-in rechargeable battery needs to be discarded properly. Contact your local Audio-Technica dealer to learn how to properly dispose of the battery.

### For customers in the USA

#### FCC Notice

##### Warning

This device complies with Part 15 of the FCC Rules.

Operation is subject to the following two conditions: (1)

This device may not cause harmful interference, and (2) this device must accept any interference received, including interference that may cause undesired operation.

##### Caution

You are cautioned that any changes or modifications not expressly approved in this manual could void your authority to operate this equipment.

**Note:** This equipment has been tested and found to comply with the limits for a Class B digital device, pursuant to part 15 of the FCC Rules. These limits are designed to provide reasonable protection against harmful interference in a residential installation. This equipment generates, uses and can radiate radio frequency energy and, if not installed and used in accordance with the instructions, may cause harmful interference to radio communications. However, there is no guarantee that interference will not occur in a particular installation. If this equipment does cause harmful interference to radio or television reception, which can be determined by turning the equipment off and on, the user is encouraged to try to correct the interference by one or more of the following measures:

- Reorient or relocate the receiving antenna.
- Increase the separation between the equipment and receiver.
- Connect the equipment to an outlet on a circuit different from that to which the receiver is connected.
- Consult the dealer or an experienced radio/TV technician for help.

### RF Exposure Statement

This transmitter must not be co-located or operated in conjunction with any other antenna or transmitter used in other systems. This device complies with FCC radiation exposure limits set forth for an uncontrolled environment and meets the FCC radio frequency (RF) Exposure Guidelines. This equipment has very low levels of RF energy that is deemed to comply without testing of specific absorption rate (SAR).

### For customers in Canada

#### IC statement

CAN ICES-3 (B)/NMB-3(B)

This device complies with Industry Canada's licence-exempt RSSs. Operation is subject to the following two conditions: (1) This device may not cause interference; and (2) This device must accept any interference, including interference that may cause undesired operation of the device.

Under Industry Canada regulations, this radio transmitter may only operate using an antenna of a type and maximum (or lesser) gain approved for the transmitter by Industry Canada. To reduce potential radio interference to other users, the antenna type and its gain should be so chosen that the equivalent isotropically radiated power (e.i.r.p.) is not more than that necessary for successful communication.

This device complies with RSS-102 radiation exposure limits set forth for an uncontrolled environment.

## Notes on use

---

- Be sure to read the connected device's user manual before use.
- Audio-Technica will not be liable in any way for any loss of data in the unlikely event that such losses should occur while using the product.
- On public transportation or in other public places, keep the volume low so as not to disturb other people.
- Minimize the volume on your device before connecting the product.
- When using the product in a dry environment, you may feel a tingling sensation in your ears. This is caused by static electricity accumulated on your body, not by product malfunction.
- Do not subject the product to strong impact.
- Do not store the product in direct sunlight, near heating devices, or in hot, humid, or dusty places. Additionally, do not allow the product to get wet.
- When the product is used for a long time, the product may become discolored due to ultraviolet light (especially direct sunlight) and wear.
- Make sure to hold the plug when connecting and disconnecting the USB charging cable. The USB charging cable may become severed or an accident may occur if you pull on the cable itself.
- When you are not using the USB charging cable, disconnect it from the product.
- If the product is placed in a bag while the USB charging cable is still connected, the USB charging cable may become caught, severed, or broken.
- Do not bring a magnetic card, etc. close to the transceiver. It may cause a malfunction.
- If the transceiver is connected to the USB port on the back of your computer, the radio wave may be interrupted. In that case, connect to the USB port on the side or front of your computer.
- If you use the product near an electronic device or transmitter (such as a mobile phone) which is not connected with the product, unwanted noise may be heard. In this case, move the product away from the electronic device or transmitter.
- If you use the product near a TV or radio antenna, noise may be seen or heard in the television or radio signal. In this case, move the product away from the TV or radio antenna.
- To protect the built-in rechargeable battery, charge it at least once every 6 months. If too much time passes between charges, the life of the rechargeable battery may be reduced, or the rechargeable battery may no longer be able to be charged.

## Part names and functions

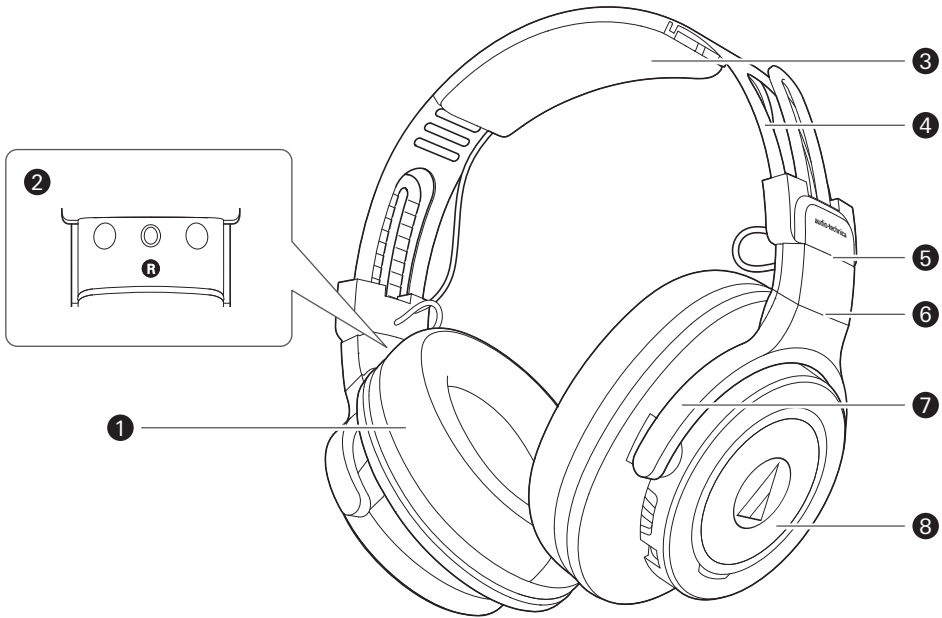

① Earpad

② L/R (left/right) indicator

③ Headpad

④ Headband

⑤ Slider

⑥ Joint

⑦ Arm

⑧ Housing

## Part names and functions

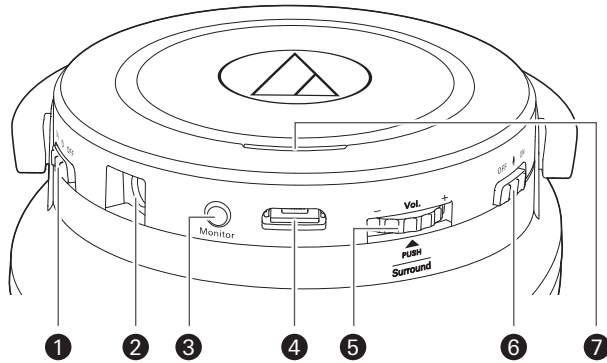

- 1 Power switch**  
Turns the power on and off.
- 2 Connector jack for detachable microphone**  
Use to connect the included detachable microphone.
- 3 Microphone monitor button**  
Use to monitor your voice.
- 4 Battery jack**  
Use to connect the included USB charging cable and charge the product.
- 5 Volume/surround sound selector switch**  
Used to adjust the volume and turn virtual surround playback on and off
- 6 Mute switch**  
Turns the microphone mute on and off.
- 7 Multi-indicator lamp**  
Displays the operating status and battery level of the product.

### ■ Accessories

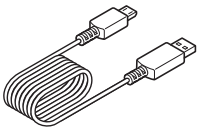

- USB charging cable (2 m (6.6'), USB Type-A / Micro USB Type-B)



- Transceiver (USB Type-A)

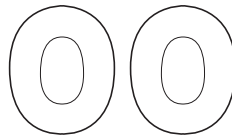

- Spare earpads

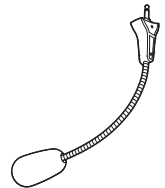

- Detachable microphone (with windscreen)

# Charging the battery

- Fully charge the battery when using for the first time.
  - When the rechargeable battery is running low, the product will beep through the headphones, and an indicator lamp will flash in red. In this case, charge the battery.
  - It takes about 7 hours maximum to charge the battery fully. (This time may vary depending on usage conditions.)
  - This product can be used while charging. If you charge while using the product, the charging time will be longer.
1. Connect the included USB charging cable (Micro USB Type-B side) to the battery jack.
    - The included USB charging cable is designed for exclusive use with the product. Do not use other cables to charge the product.
    - When inserting the USB charging cable into the USB port or battery jack, check that the connector is facing in the correct direction before inserting it directly (horizontally).

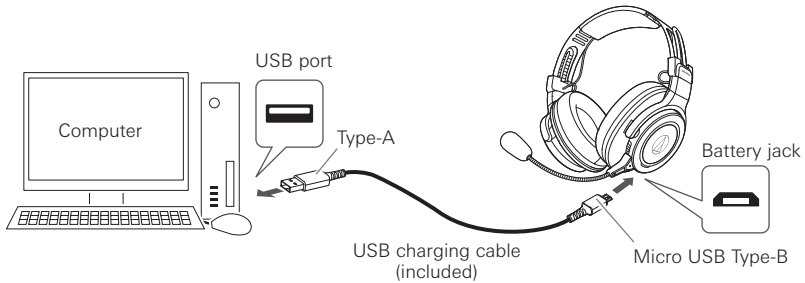

2. Connect the included USB charging cable (USB Type-A side) to the computer to start charging.
  - While charging, the indicator lamp lights as follows (it may take several seconds for the indicator lamp to light).  
Lit in red: Charging  
Off: Charging complete
3. When charging is complete, disconnect the USB charging cable (USB Type-A side) from the computer.
4. Disconnect the USB charging cable (Micro USB Type-B) from the product's battery jack.

- When charging, make sure to use the included USB charging cable. The product may not charge with cables other than the included USB charging cable.

# Connecting via 2.4 GHz digital wireless technology

To connect the product to a Windows PC/Mac, the product needs to pair (register) with the Windows PC/Mac. It is necessary to plug the transceiver to your Windows PC/Mac in order to use the product. Audio-Technica does not support the connection with gaming console devices.

## Pairing a Windows PC/Mac

Read the user manual for the Windows PC/Mac.

1. Starting with the product turned off, slide the power switch to the "ON" position.

- The multi-indicator lamp will light in blue, and then flash.

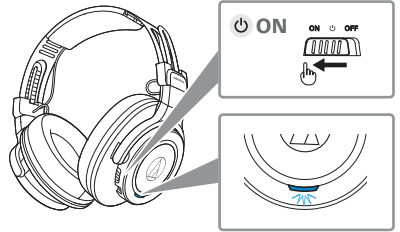

2. Attach the included transceiver to the Windows PC/Mac.
- The multi-indicator lamp will light in blue, and then flash.

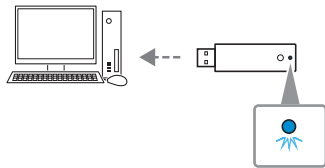

3. The product pairs automatically.
- The product sounds a confirmation tone when pairing is complete.
  - The multi-indicator lamp of the product and the indicator of the transceiver start to blink blue at intervals of 5 seconds.

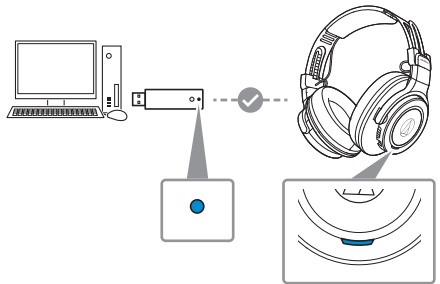

4. Check the sound settings of the Windows PC/Mac and make sure that "ATH-G1WL" is selected.

## Pairing manually

When you are unable to pair, you can pair manually.

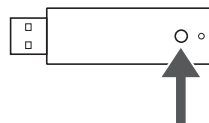

1. Press and hold (for 8 seconds) the microphone monitor button and the volume/surround sound selector switch.
- The multi-indicator lamp will light in red and blue simultaneously and the product will start to search for devices.
2. Press the transceiver's button.
- The product sounds a confirmation tone when repairing is complete.





# Using the product

## Power supply ON/OFF

Power supply	Power switch operation	Indicator lamp
ON		Lights in blue, then flashes in blue *1 *2
OFF		Lights in blue, then turns off *2

\*1 It may take several seconds for the indicator lamp to light.

\*2 For details, refer to "Indicator lamp display" (p. 11).

- Lower the volume of the Windows PC/Mac, and then connect the product and adjust to the desired volume.

## Wearing the product

1. Attach the detachable microphone to the product.
  - Make sure that the detachable microphone is attached securely.



2. Put the side of the product marked "L" (LEFT) onto the left ear and the side marked "R" (RIGHT) onto the right ear, slide the slider up and down so that the earpads cover the ears, and then adjust the headband.



3. Adjust the microphone near the corner of your mouth.

## Using the product

### Swivel mechanism

You can fold the housing so that it lies flat.

- The swivel mechanism cannot rotate more than 90 degrees. Do not apply excessive force.

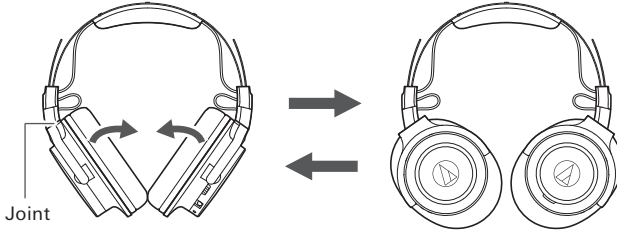

### Button operation

#### Microphone monitor button

You can check the sound of your voice during use by pressing the microphone monitor button. Each time the microphone monitor button is pressed, it switches between ON and OFF.

#### Volume/surround sound selector switch

Use to adjust the volume and turn virtual surround playback on and off..

Slide toward +	Increases the volume by 1 level.*1
Slide toward -	Decreases the volume by 1 level.*1
Press	Each time you press the volume/surround sound selector switch, you switch ON/OFF.*2

\*1 A beep is heard when the volume is at the maximum or minimum level.

\*2 A confirmation tone sounds each time you switch ON/OFF.

#### Mute switch

To mute the microphone, switch the mute switch to ON.

## Using the product

### Auto power off function

The product automatically turns off after 5 minutes of not being connected to the transceiver that has its power turned on.

### Reset function



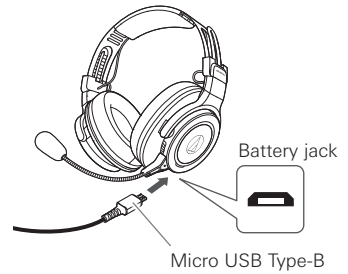

If the product does not work or other malfunctions occur, refer to “Charging the battery” (p. 6) for information on inserting the USB charging cable to provide power, and then do a reset. Disconnecting and then reconnecting the USB charging cable will reset the product and should resolve any problem you are experiencing. If the problem persists, contact your local Audio-Technica dealer. Resetting does not change any of your settings (pairing information, volume setting, etc.).





# Indicator lamp display

The indicator lamp of the product indicates the product's status as explained below.

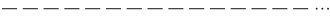
## Headphones

Status		Indicator lamp display pattern <span style="color: red;">●</span> Red <span style="color: blue;">●</span> Blue	
Pairing	Searching for device		Flashing
Connection	Connecting		Flashing every 5 seconds
	During virtual surround playback		Flashing three times
Battery level	Battery level low	The blue connection indicator and a red low-battery indicator will be displayed simultaneously.	
Charging	Charging (power OFF)		Lit
	Charging (power ON, connecting)	The blue connection indicator and red charging indicator will be displayed simultaneously.	
	Charging (power ON, searching for devices)	The "Search for device" indicator and red charging indicator will be displayed simultaneously.	
	Fully charged		Off

## Transceiver

Status		Indicator lamp display pattern <span style="color: blue;">●</span> Blue	
Pairing	Searching for device		Flashing
Connection	Connecting		Flashing every 5 seconds

## Cleaning

---

Get into the habit of regularly cleaning the product to ensure that it will last for a long time. Do not use alcohol, paint thinners or other solvents for cleaning purposes.

- To clean, wipe with a dry cloth.
- Wipe away dirt from the earpads and headpad with a dry cloth. Since sweat or water on the earpads and headpad may cause the colors to fade, we recommend wiping moisture from them with a dry cloth and placing the product away from direct sunlight to air-dry.
- If the product will not be used for an extended period of time, store it in a well-ventilated place free from high temperatures and humidity.
- Earpads are consumable parts. Replace them when necessary as they will deteriorate through storage and use. Contact your local Audio-Technica dealer for earpads replacement or other repairs.

# Troubleshooting

<b>Problem</b>	<b>Solution</b>
Power is not supplied.	<ul style="list-style-type: none"><li>• Turn the product off and turn it on again.</li><li>• Charge the product.</li></ul>
Unable to pair.	<ul style="list-style-type: none"><li>• Place the product and the transceiver within 1 m (3.3') of each other.</li><li>• If pairing is not successful, you can perform pairing manually. Refer to “Pairing manually” (p. 7).</li></ul>
No sound is heard / Sound is faint.	<ul style="list-style-type: none"><li>• Turn on the power of the Windows PC/Mac.</li><li>• Turn up the volume of the Windows PC/Mac.</li><li>• Move away from obstacles between the product and the Windows PC/Mac, such as people, metal or walls, and place them closer together.</li><li>• Make sure that the product is selected as the output device in the sound setting of the Windows PC/Mac.</li><li>• Make sure that the product and transceiver are properly paired.</li><li>• Audio-Technica does not support the connection with gaming console devices. Even if pairing is complete, you may not hear audio.</li></ul>
Sound is distorted / Noise is heard / Sound cuts out.	<ul style="list-style-type: none"><li>• Turn down the volume of the Windows PC/Mac.</li><li>• Keep the product away from devices that emit radio waves such as microwaves, wireless routers and mobile phones.</li><li>• Keep the product away from TVs, radios, and devices with built-in tuners. These devices can also be affected by the product.</li><li>• Move away from obstacles between the product and the Windows PC/Mac, such as people, metal or walls, and place them closer together.</li><li>• Turn off the microphone monitor button.</li></ul>
Cannot hear the voice of the caller / Voice of the caller is too quiet.	<ul style="list-style-type: none"><li>• Turn on the power of the product and the Windows PC/Mac.</li><li>• Turn up the volume of the product and the Windows PC/Mac.</li><li>• Make sure that the product is selected as the output device in the sound setting of the Windows PC/Mac.</li><li>• Make sure that the product and transceiver are properly paired.</li><li>• Audio-Technica does not support the connection with gaming console devices. Even if pairing is complete, you may not hear audio.</li></ul>
My voice cannot be heard from others.	<ul style="list-style-type: none"><li>• Turn on the power of the Windows PC/Mac.</li><li>• Turn up the volume of the Windows PC/Mac.</li><li>• Make sure that the mute switch is off.</li><li>• Make sure that the detachable microphone is securely attached.</li><li>• Make sure that the detachable microphone is close to your mouth.</li><li>• Make sure that the product is selected as the input device in the sound setting of the Windows PC/Mac.</li><li>• Make sure that the product and transceiver are properly paired.</li><li>• Audio-Technica does not support the connection with gaming console devices. Even if pairing is complete, you may not hear audio.</li></ul>
The product cannot be charged.	<ul style="list-style-type: none"><li>• Securely connect the included USB charging cable and charge the product.</li></ul>

- For details about how to operate your Windows PC/Mac, refer to the user manual of the Windows PC/Mac.

# Specifications

## Headphones

Type	Closed-back dynamic
Driver	45 mm
Sensitivity	101 dB/mW
Frequency response	5 to 40,000 Hz
Impedance	45 ohms
Power supply	DC 3.8 V lithium polymer battery
Weight	Approx. 290 g (10.2 oz) / Approx. 297 g (10.5 oz) (including detachable microphone)

## Microphone

Type	Electret condenser
Polar pattern	Hypercardioid
Sensitivity	-43 dB (1 V/Pa, at 1 kHz)
Frequency response	30 to 20,000 Hz

## Transceiver

RF output	12.5 mW EIRP
Maximum communication range	Line of sight - approx. 12 m (39')
Frequency band	2.404 GHz to 2.476 GHz
Modulation method	AFH
Transmission band	20 to 24,000 Hz
Power supply	DC 5 V (USB BUS POWER)
Dimensions	18 mm (0.71") × 55 mm (2.17") × 10 mm (0.39") (W × D × H) (without connector)
Weight	9 g (0.32 oz)

## Specifications for computer connection (operating environment)

Supported operating systems	Windows 7, Windows 8.1, Windows 10 (32/64 bit) macOS High Sierra, Mojave (Visit our website for the latest information about the product.)
Supported USB port	USB 2.0, USB 3.0

# Specifications

## Other

Charging time	Approx. 7 hours*
Operating time	Continuous transmission time: Max. approx. 15 hours*
Operating temperature	5°C to 40°C (41° F to 104°F)
Accessories	<ul style="list-style-type: none"><li>• USB charging cable (2 m (6.6'), USB Type-A / Micro USB Type-B)</li><li>• Transceiver</li><li>• Spare earpads</li><li>• Detachable microphone (with windscreen)</li></ul>
Sold separately	<ul style="list-style-type: none"><li>• Earpad</li></ul>

\* The above figures depend on operating conditions.

For product improvement, the product is subject to modification without notice.

- Microsoft® and Windows® are registered trademarks of Microsoft Corporation in the United States and/or other countries.
- Microsoft Windows operating system is indicated in its abbreviated form as Windows.
- Apple and Mac OS are trademarks of Apple Inc., registered in the U.S. and other countries.