

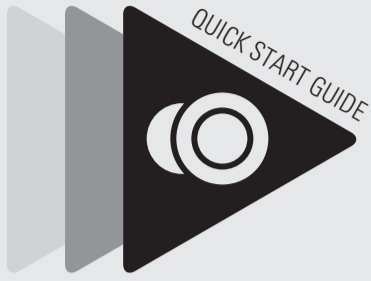

audio-technica



ATH-CK3TW

Check



- Headphones
- Charging case
- Eartips (XS, S, M, L)
- USB charging cable
- Quick start guide (this leaflet)
- Caution guide

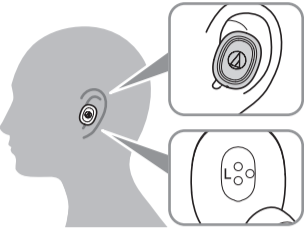

Charge

Charging case

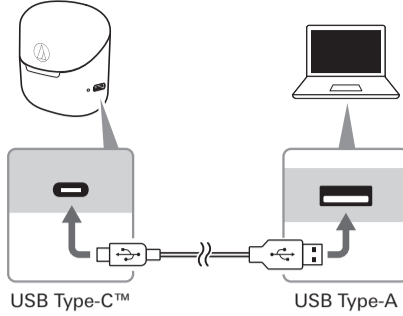

USB Type-C™

USB Type-A

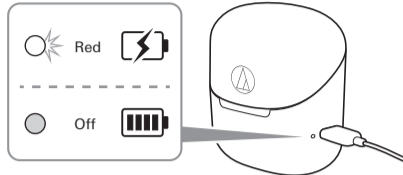

Red

Off

Headphones

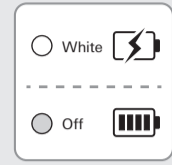
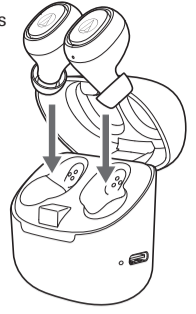

White

Off

Pairing

1 ON

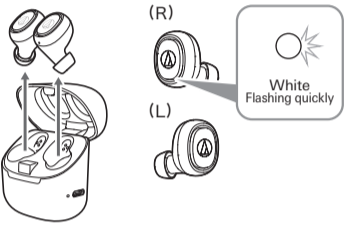

(R)

(L)

White Flashing quickly

2

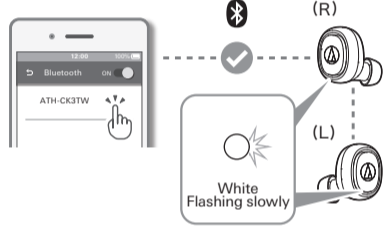

(R)

(L)

White Flashing slowly

Music / Phone

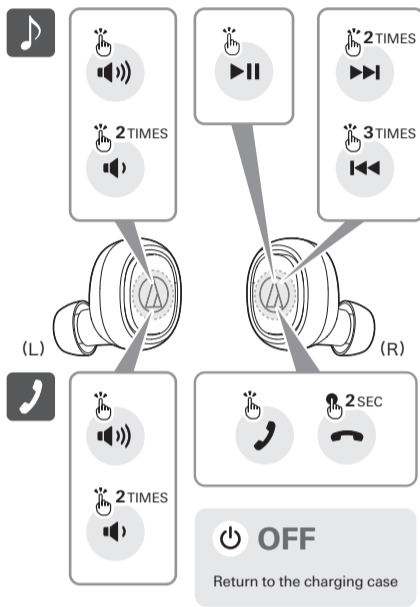

(L)

(R)

OFF

Return to the charging case

Ear Detection ON/OFF

Default OFF

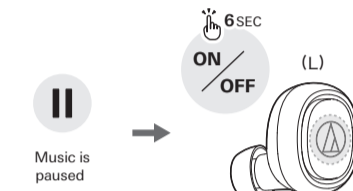

Music is paused

Ear Detection ON

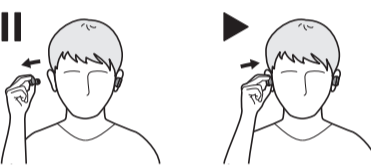

The product pauses music when removed, and resumes playback when worn again.

Support

For more information on how to use this product and troubleshoot any problems, refer to the user manual on the Audio-Technica website.



www.audio-technica.com

The Bluetooth® word mark and logos are owned by Bluetooth SIG, Inc. and any use of such marks by Audio-Technica Corporation is under license. All other trademarks are property of their respective owners.

Audio-Technica Corporation
2-46-1 Nishi-naruse, Machida, Tokyo 194-8666, Japan
www.audio-technica.co.jp
©2019 Audio-Technica Corporation 139507560-01-01 ver.1 2019.09.15

Français / Deutsch / Italiano

Contrôle / Kontrolle / Controllo



- Écouteurs / Kopfhörer / Cuffie
- Étui chargeur / Ladegehäuse / Alloggiamento per la ricarica
- Embout (TP, P, M, G) / Kopfhöreraufsätze (XS, S, M, L) / Copriauricolari (XS, S, M, L)
- Câble de recharge USB / USB-Ladekabel / Cavo per la carica USB
- Guide de prise en main (ce dépliant) / Kurzanleitung (dieser Handzettel) / Guida rapida (questo opuscolo)
- Guide de mise en garde / Sicherheitsanweisungen / Guida precauzionale

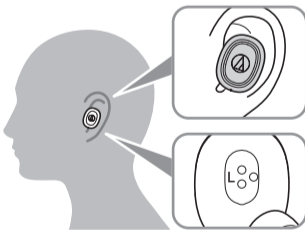

Charge / Laden / Carica

Étui chargeur / Ladegehäuse / Alloggiamento per la ricarica

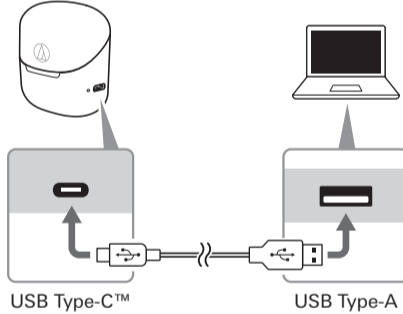

USB Type-C™

USB Type-A

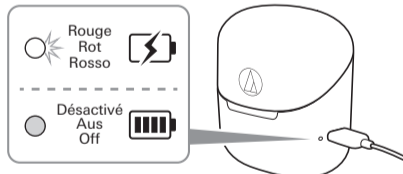

Rouge / Rot / Rosso

Désactivé / Aus / Off

Écouteurs / Kopfhörer / Cuffie

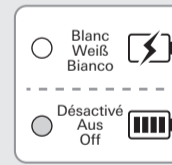
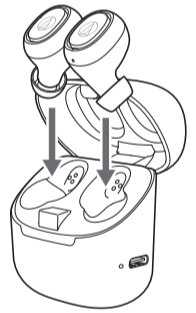

Blanc / Weiß / Bianco

Désactivé / Aus / Off

Appairage / Paarung / Associazione

1 ON

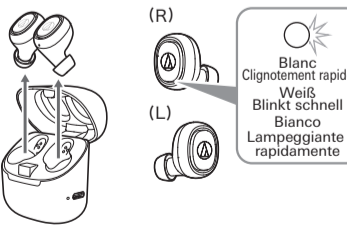

(R)

(L)

Blanc Clignotement rapide / Weiß Blinkt schnell / Bianco Lampeggiante rapidamente

2

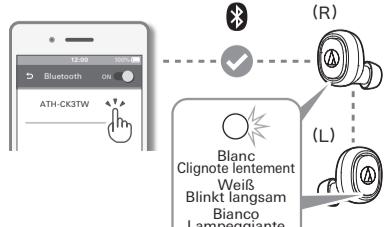

(R)

(L)

Blanc Clignote lentement / Weiß Blinkt langsam / Bianco Lampeggiante lentamente

Musique/Téléphone / Musik/Handy / Musica/Telefono

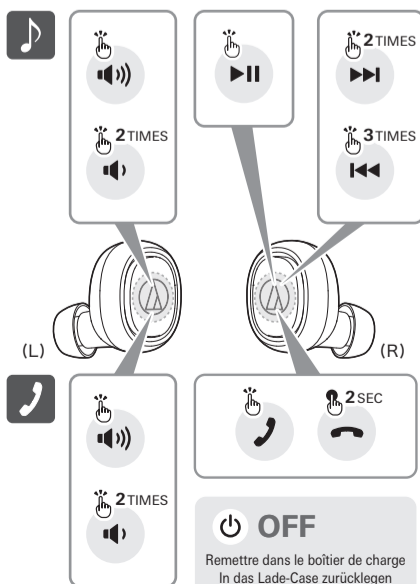

(L)

(R)

OFF

Remette dans le boîtier de charge / In das Lade-Case zurücklegen / Riporre nella custodia

Détection oreilles ON/OFF / Ohrerkennung ON/OFF / Rilevamento orecchio ON/OFF

OFF par défaut / Standardeinstellung OFF / Impostazione standard OFF

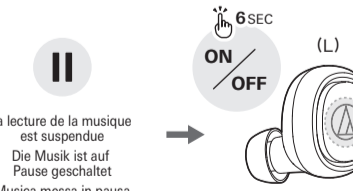

La lecture de la musique est suspendue / Die Musik ist auf Pause geschaltet / Musica messa in pausa

Détection oreilles ON / Ohrerkennung ON / Rilevamento orecchio ON



Le produit suspend la lecture de musique lorsqu'il est retiré et reprend la lecture lorsqu'il est à nouveau porté. / Die Musik wird auf Pause geschaltet, wenn das Produkt abgenommen wird, und die Wiedergabe wird fortgesetzt, wenn es wieder getragen wird. / Il prodotto mette in pausa la musica quando viene rimosso, e torna in riproduzione quando lo si indossa nuovamente.

Support / Unterstützung / Assistenza

Pour plus d'informations sur l'utilisation de ce produit et la résolution des problèmes, reportez-vous au manuel de l'utilisateur sur le site Web d'Audio-Technica.

Weitere Informationen zum Gebrauch dieses Produkts und zur Behebung eventueller Probleme entnehmen Sie bitte der Bedienungsanleitung auf der Website von Audio-Technica.

Per maggiori informazioni sull'utilizzo del presente prodotto e per la risoluzione di eventuali problemi, fare riferimento al manuale dell'utente sul sito Audio-Technica.



www.audio-technica.com

La marque verbale et les logos Bluetooth® sont détenus par Bluetooth SIG, Inc., et ces marques sont utilisées sous licence par Audio-Technica Corporation. Toutes les autres marques de commerce sont la propriété de leurs détenteurs respectifs.

USB type-C™ est une marque commerciale d'USB Implementers Forum.

Die Bluetooth®-Wortmarke und -Logos sind Eigentum von Bluetooth SIG, Inc., und die Nutzung dieser Marken durch Audio-Technica Corporation erfolgt unter Lizenz. Alle anderen Markenzeichen sind Eigentum der jeweiligen Inhaber.

USB type-C™ ist eine Marke des USB Implementers Forum.

Il marchio e i logo del termine Bluetooth® sono di proprietà di Bluetooth SIG, Inc., e qualsiasi utilizzo di tali marchi da parte di Audio-Technica Corporation è soggetto a licenza. Tutti gli altri marchi sono di proprietà dei rispettivi proprietari.

USB type-C™ è un marchio dello USB Implementers Forum.

✓ Comprobar / Conteúdo da embalagem / Проверка

- Auriculares / Fones de ouvido / Наушники
- Estuche de carga / Estojo de carregamento / Чехол-аккумулятор
- Puntas de audífono (XS, S, M, L) / Ponteiros (PP, P, M, G) / Насадки (размеры XS, S, M, L)
- Cable de carga USB / Cabo de carga USB / USB-кабель для зарядки
- Guía de inicio rápido (este folleto) / Guia rápida (este folheto) / Краткое руководство пользователя (этот листок)
- Guía de precauciones / Guia de precauções de segurança / Руководство по мерам предосторожности

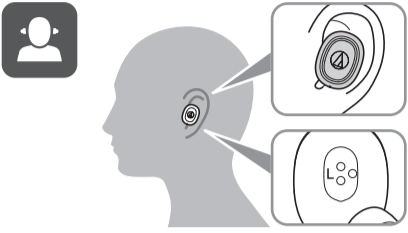

⚡ Carga / Carregar / Заряд

Estuche de carga / Estojo de carregamento / Чехол-аккумулятор

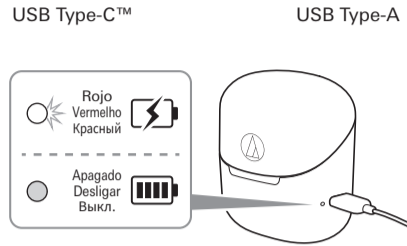
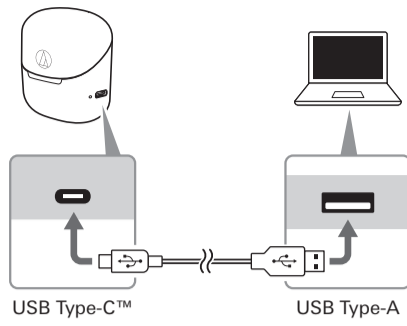

Auriculares / Fones de ouvido / Наушники

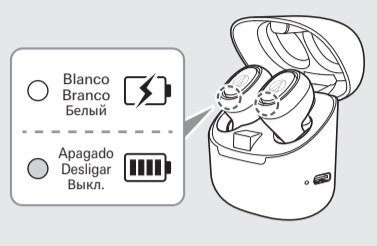
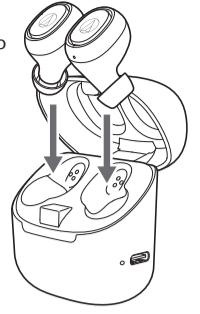

📶 Emparejamiento / Emparelhamento / Сопряжение

1 **ON**

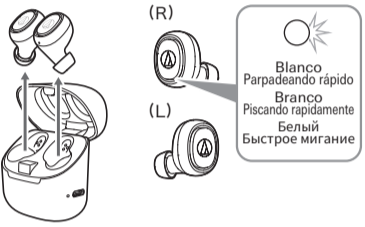

2

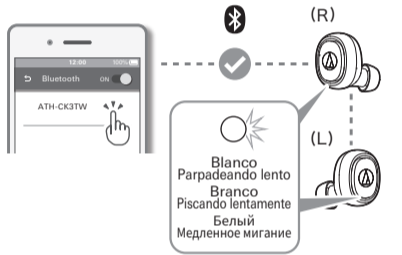

🎵 Música/Teléfono / Música/Telefone / Музыка/Телефон

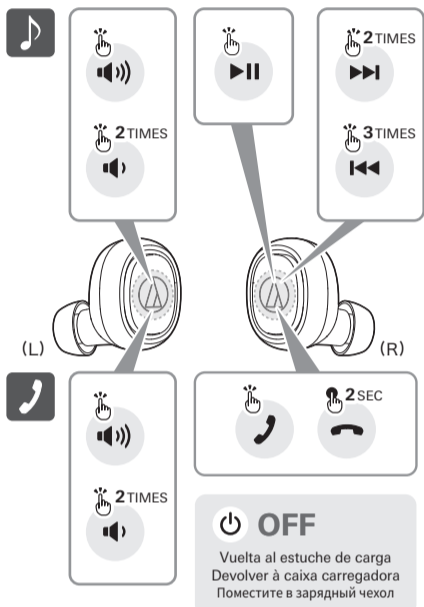

👂 Detección de oídos activada/desactivada / Detecção de orelha LIGADA/DESLIGADA / Обнаружение надевания ВКЛ/ВЫКЛ

Por defecto OFF / Padrão OFF / Настройка по умолчанию OFF

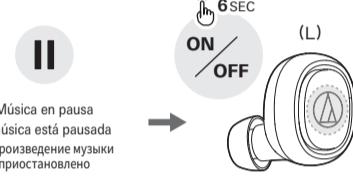

Detección de oídos activada / Detecção de orelha LIGADA / Обнаружение надевания ВКЛ

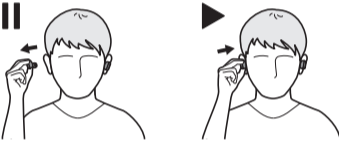

El producto pausa la música cuando se quita y reanuda la reproducción cuando se vuelve a poner. O produto pausa a música quando removido da orelha e retomará a reprodução quando for colocado novamente. Изделие приостанавливает воспроизведение музыки при снятии наушников и возобновляет его, когда вы снова надеваете их.

📖 Asistencia / Suporte / Техническая поддержка

Para más información sobre el uso de este producto y la resolución de problemas, consulte el manual de usuario en el sitio web de Audio-Technica.

Para obter mais informações sobre como usar este produto e solucionar qualquer problema, consulte o manual do usuário no site da Audio-Technica.

Для получения дополнительной информации о том, как использовать этот продукт и устранять любые неисправности, обратитесь к руководству пользователя на веб-сайте Audio-Technica.



www.audio-technica.com

- La palabra con la marca **Bluetooth**™ y los logotipos son propiedad de Bluetooth SIG, Inc., y Audio-Technica Corporation los utiliza bajo licencia. El resto de marcas comerciales son propiedad de sus respectivos propietarios.
- USB type-C™ es una marca comercial de USB Implementers Forum.
- A marca nominativa e os logotipos **Bluetooth**™ são de propriedade da Bluetooth SIG, Inc. e qualquer uso dessas marcas pela Audio-Technica Corporation é feito sob licença. Todas as outras marcas comerciais são de propriedade de seus respectivos proprietários.
- USB type-C™ é uma marca registrada do USB Implementers Forum.
- Словесный знак и логотипы **Bluetooth**™ принадлежат Bluetooth SIG, Inc. Любое использование таких знаков компанией Audio-Technica Corporation осуществляется в соответствии с лицензией. Все остальные товарные знаки являются собственностью соответствующих владельцев.
- USB type-C™ является товарным знаком USB Implementers Forum.

✓ 检查 / 検査 / 확인

- 耳机 / 耳機 / 이어폰
- 充电盒 / 充電盒 / 충전 케이스
- 耳套 (XS, S, M, L) / 耳塞 (XS·S·M·L) / 이어팁(XS, S, M, L)
- USB充电线 / USB充電線 / USB 충전 케이블
- 快速入门指南 (本说明书) / 快速入門指南 (本手冊) / 빠른 시작 가이드(본 소책자)
- 注意事项指南 / 注意事項 / 주의사항 안내

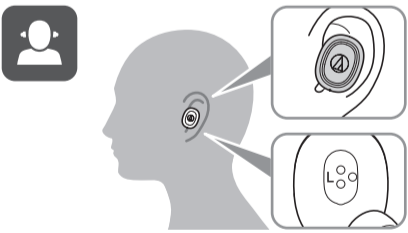

⚡ 充电 / 充電 / 충전

充电盒 / 充電盒 / 충전 케이스

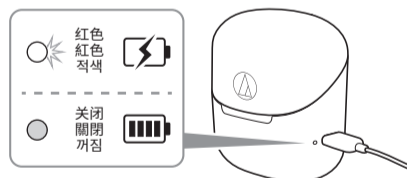
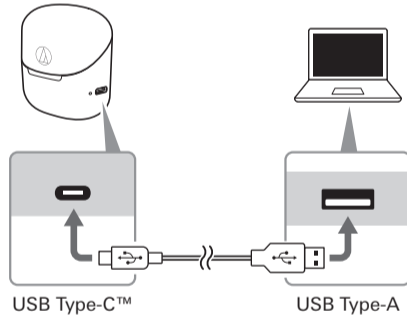

耳机 / 耳機 / 이어폰

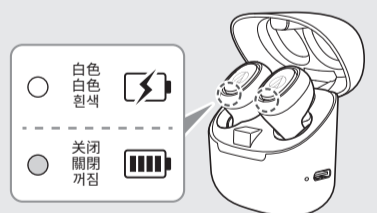

📶 配对 / 配對 / 페어링(연결)

1 **ON**

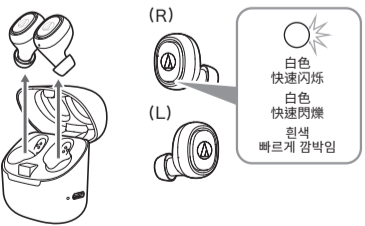

2

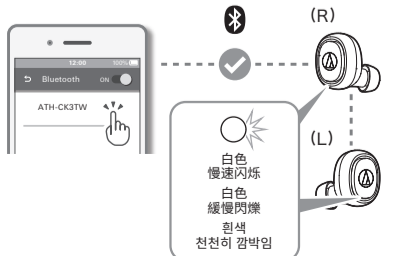

🎵 音乐/电话 / 音樂/電話 / 음악/전화

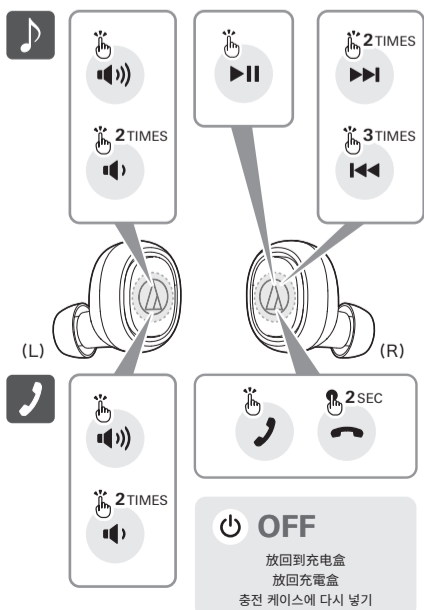

👂 耳朵检测开/关 / 耳朵偵測開/關 / 귀감지 ON/OFF

默认 OFF / 預設 OFF / 디폴트 OFF

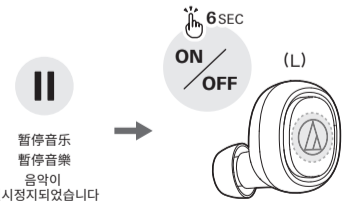

耳朵检测开 / 耳朵偵測開 / 귀감지 ON

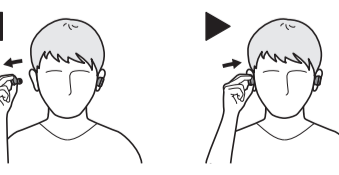

本产品在下取时暂停音乐，并在重新佩戴后恢复播放。本產品會在取出時暫停音樂，並在重新配戴時繼續播放。제거되면 제품이 음악을 일시정지하고 장착하면 다시 재생됩니다.

📖 支持信息 / 支援資訊 / 지원

关于如何使用本产品及解决各种问题的详细信息，请参阅“铁三角”网站上的用户手册。

有關本產品的使用方法以及各種問題的故障排除方法，請參閱「鐵三角」網站上的使用說明書。

본 제품의 사용법 및 문제 해결에 관한 자세한 사항은 Audio-Technica 웹사이트의 사용자 설명서를 참조하십시오.



www.audio-technica.com

- 蓝牙®文字商标和徽标归蓝牙技术联盟 (Bluetooth SIG, Inc.) 所有。“铁三角”公司已获得其使用授权。所有其他商标均归其各自所有者所有。
- USB type-C™是 USB Implementers Forum 的商标。
- 蓝牙®文字標記和標誌屬Bluetooth SIG·Inc 所有。「鐵三角」公司已取得該標記之使用許可。所有其他商標均為其各自所有者的財產。
- USB type-C™是 USB Implementers Forum 的商標。
- Bluetooth® 단어 마크 및 로고는 Bluetooth SIG, Inc.의 소유이며 Audio-Technica Corporation은 이러한 마크에 대한 사용 허가를 받았습니다. 기타 모든 상표는 해당 소유주의 재산입니다.
- USB type-C™는 USB Implementers Forum의 상표입니다.