

# ALLEN & HEATH



**MixRack Getting Started Guide**

**CDM32, CDM48, CDM64**

**ⓘ** Before starting please check [www.allen-heath.com](http://www.allen-heath.com) for the latest dLive firmware and documentation.

## **Limited One Year Manufacturer's Warranty**

Allen & Heath warrants the Allen & Heath -branded hardware product and accessories contained in the original packaging ("**Allen & Heath Product**") against defects in materials and workmanship when used in accordance with Allen & Heath's user manuals, technical specifications and other Allen & Heath product published guidelines for a period of ONE (1) YEAR from the date of original purchase by the end-user purchaser ("**Warranty Period**").

This warranty does not apply to any non-Allen & Heath branded hardware products or any software, even if packaged or sold with Allen & Heath hardware.

Please refer to the licensing agreement accompanying the software for details of your rights with respect to the use of software/firmware ("EULA").

Details of the EULA, warranty policy and other useful information can be found on the Allen & Heath website: [www.allen-heath.com/legal](http://www.allen-heath.com/legal).

Repair or replacement under the terms of the warranty does not provide right to extension or renewal of the warranty period. Repair or direct replacement of the product under the terms of this warranty may be fulfilled with functionally equivalent service exchange units.

This warranty is not transferable. This warranty will be the purchaser's sole and exclusive remedy and neither Allen & Heath nor its approved service centres shall be liable for any incidental or consequential damages or breach of any express or implied warranty of this product.

### **Conditions Of Warranty**

The equipment has not been subject to misuse either intended or accidental, neglect, or alteration other than as described in the User Guide or Service Manual, or approved by Allen & Heath. The warranty does not cover fader wear and tear.

Any necessary adjustment, alteration or repair has been carried out by an authorised Allen & Heath distributor or agent.

The defective unit is to be returned carriage prepaid to the place of purchase, an authorised Allen & Heath distributor or agent with proof of purchase. Please discuss this with the distributor or the agent before shipping. Units returned should be packed in the original carton to avoid transit damage.

**DISCLAIMER:** Allen & Heath shall not be liable for the loss of any saved/stored data in products that are either repaired or replaced.

Check with your Allen & Heath distributor or agent for any additional warranty information which may apply. If further assistance is required please contact Allen & Heath Ltd.



dLive products comply with the European Electromagnetic Compatibility directive 2014/30/EU and the European Low Voltage directive 2014/35/EU.

Any changes or modifications to the product not approved by Allen & Heath could void the compliance of the product and therefore the user's authority to operate it.

### **dLive MixRack Getting Started Guide**

Copyright © 2016 Allen & Heath. All rights reserved.

# **ALLEN & HEATH**

Allen & Heath Limited, Kernick Industrial Estate, Penryn, Cornwall, TR10 9LU, UK

<http://www.allen-heath.com>

# IMPORTANT - Read before starting

## Safety instructions

Before starting, read the **Important Safety Instructions** printed on the sheet supplied with the equipment. For your own safety and that of the operator, technical crew and performers, follow all instructions and heed all warnings printed on the sheet and on the equipment panels.

## System operating firmware

The function of the dLive MixRack is determined by the firmware (operating software) that runs it. Firmware is updated regularly as new features are added and improvements made.

ⓘ Check [www.allen-heath.com](http://www.allen-heath.com) for the latest version of dLive firmware.

## Software licence agreement

By using this Allen & Heath product and the software within it you agree to be bound by the terms of the relevant **End User Licence Agreement** (EULA), a copy of which can be found at [www.allen-heath.com/legal](http://www.allen-heath.com/legal). You agree to be bound by the terms of the EULA by installing, copying, or using the software.

## Further information

Please refer to the **Allen & Heath website** for further information, knowledgebase and technical support. For more information on dLive setup and mixing functions please refer to the dLive Firmware Reference Guide available for download at [www.allen-heath.com](http://www.allen-heath.com).

ⓘ Check for the latest version of this Getting Started Guide.

You can also join our Allen & Heath Digital Community to share knowledge and information with other dLive users.

## General precautions

- Protect the equipment from damage through liquid or dust contamination. Cover the MixRack when it is not being used for a long period.
- If the equipment has been stored in sub-zero temperatures allow time for it to reach normal operating temperature before use at the venue. Recommended operating temperature is 0 to 35 degrees Celsius.
- Avoid using the equipment in extreme heat and direct sunlight. Make sure the ventilation slots are not obstructed and that there is adequate air movement around the equipment.
- Clean the equipment with a soft brush and dry lint-free cloth. Do not use chemicals, abrasives or solvents.
- It is recommended that servicing is carried out only by an authorised Allen & Heath agent. Contact details for your local distributor can be found on the Allen & Heath website. Allen & Heath do not accept liability for damage caused by maintenance, repair or modification by unauthorised personnel.

## Register your product

Register your product online at [www.allen-heath.com/register](http://www.allen-heath.com/register).

# Packed items

Check you have received the following:

- CDM MixRack
- Getting Started Guide AP10643
- Safety Sheet
- IEC mains lead
- 10x M6 screws and washers for rack mounting

# Contents

IMPORTANT - Read before starting .....	3
Packed items .....	4
Contents .....	4
1. Introduction.....	5
1.1 dLive MixRacks .....	5
2. Installing the MixRack .....	7
2.1 Free standing .....	7
2.2 Rack mounting and flight casing.....	7
2.3 Rack ears .....	7
3. Rear Panel .....	8
4. Front Panel .....	10
5. Connect and power up .....	11
5.1 Surface connection .....	11
5.2 Expander connection .....	11
5.3 ME system connection.....	12
5.4 Connect a laptop or wireless router .....	12
6. Dimensions .....	13
7. Technical specs .....	14

# 1. Introduction

dLive is a distributed digital mixing system providing a uniquely flexible solution for any live sound application. It separates the mix engine from the control surface, putting the audio and processing where it is needed, and offering a host of control and audio networking possibilities. Refer to the Allen & Heath website to find out more about dLive.

The **MixRack** is the heart of any dLive system. It houses the XCVI processing core complete with audio I/O, control and audio networking ports. It is typically connected to a dLive Surface, but can also be controlled at the same time as or even without a Surface using a laptop or iPad, Allen & Heath IP remotes or third party controllers via TCP/IP. DX Expanders can be added to the system for extra I/O.

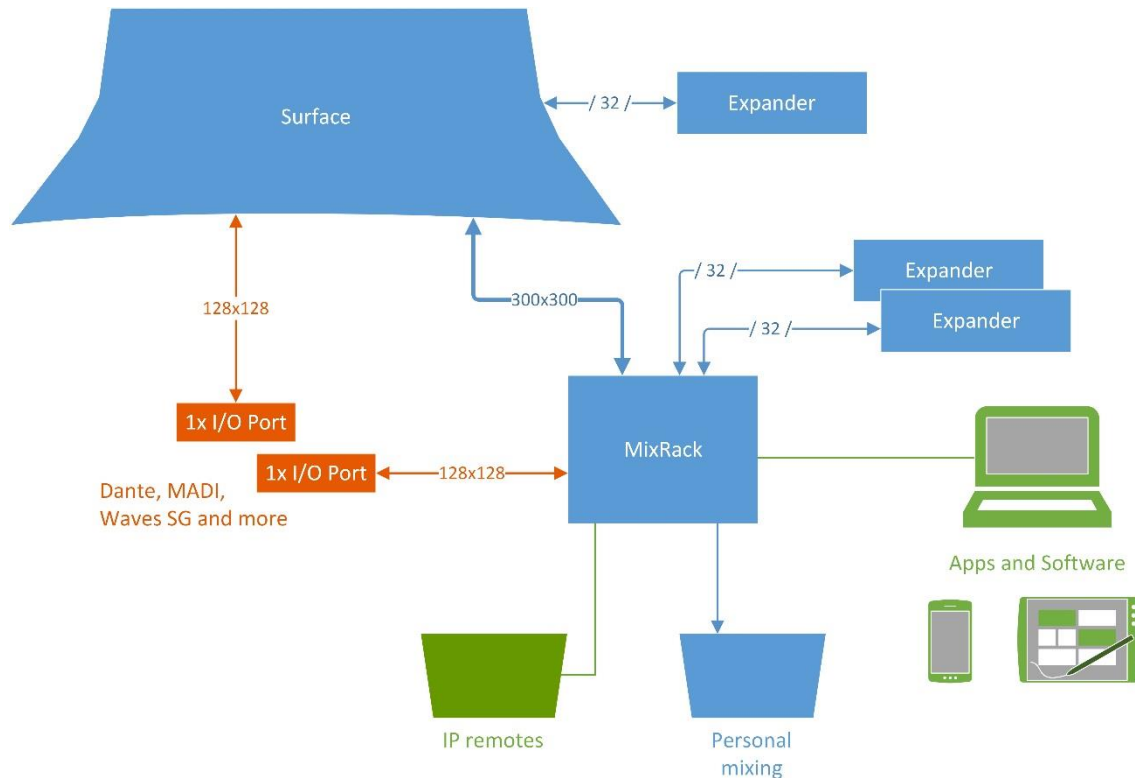

## 1.1 dLive MixRacks

There are different sizes of dLive MixRack available. All feature the same mix engine and differ only in the number of analogue I/O, PSU and cable redundancy, and number of I/O Ports. All models can work with the full 128 channels by adding DX expanders or patching digital sources.

dLive MixRack features at a glance:

- **XCVI** 160x64 FPGA core
- 96kHz sample rate, 96bit accumulator
- Class leading, ultra-low latency 0.7ms
- 128 Input Channels with full processing
- 64 Mix Outputs with full processing
- **DEEP** processing embedded channel plugins
- Configurable 64 bus architecture (group, FX, aux, matrix, mains)
- LR, LCR and up to 5.1 mains mode
- 16 RackFX with dedicated stereo returns
- Multiple PFLs
- 24 DCAs
- Built-in signal generator, RTA and spectrogram
- Flush front panel with ultra quiet fan
- Reversible rack ears design

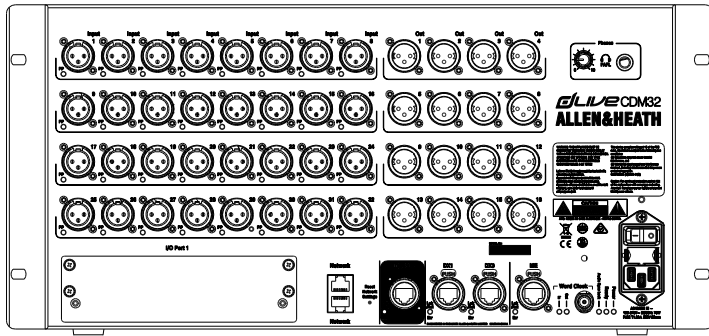

**CDM32**

32 mic/line in  
 16 XLR out  
 5U

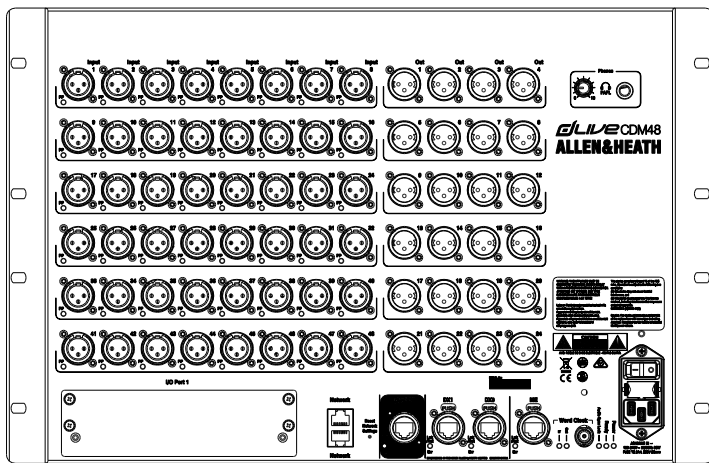

**CDM48**

48 mic/line in  
 24 XLR out  
 7U

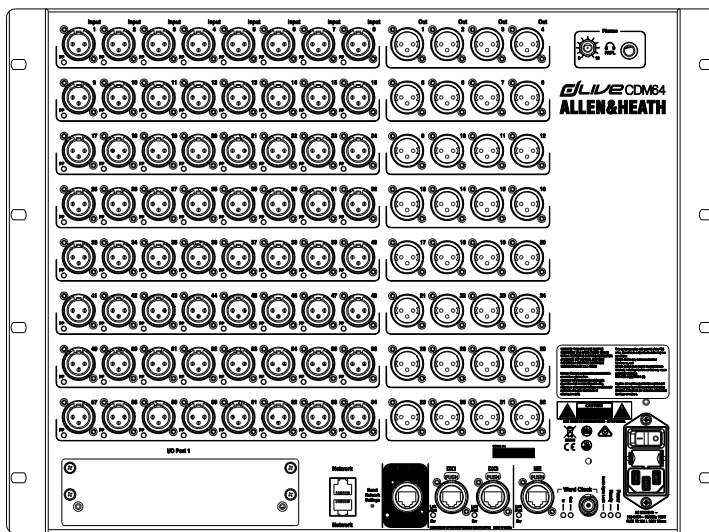

**CDM64**

64 mic/line in  
 32 XLR out  
 8U

## 2. Installing the MixRack

### 2.1 Free standing

The MixRack can be operated as a freestanding unit for shelf or floor operation. Check that its plastic feet are fitted. Ensure adequate air flow around the unit. It must not be covered in any way. Always stand the unit on a firm flat surface away from any soft furnishings or carpet.

### 2.2 Rack mounting and flight casing

The CDM32, CDM48 and CDM64 are designed as 19 inch rack mount units and occupy 5U, 7U, 8U of rack space respectively. The plastic feet may need to be removed before rack mounting; retain them for future use.

For rental, touring and other portable use, we recommend that you use a professional grade flight case with shock mounted internal rack frame.

Use the M6 screws and washers supplied with the product to rack mount.

- ⓘ Ensure natural convection of airflow around the unit by allowing good ventilation below, in front of and behind the unit. Rack equipment known to produce a significant amount of heat should not be mounted directly below the unit. Forced convection by means of a rack mounted fan-tray may be desirable in situations where space is restricted and the ambient air temperature is high.

### 2.3 Rack ears

The rack ears can be mounted facing either the front or rear panel to suit the application. They are secured to the sides of the MixRack with 3 screws each as indicated below. Remove these screws using a Pozidriv screwdriver to remove or reposition the rack ears.

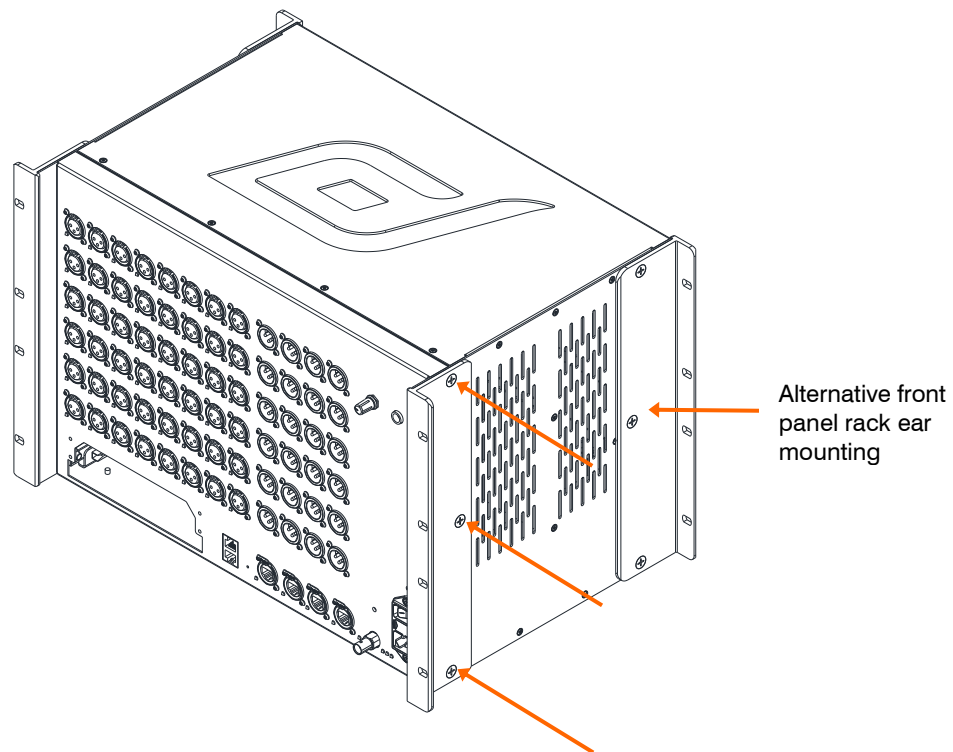

### 3. Rear Panel

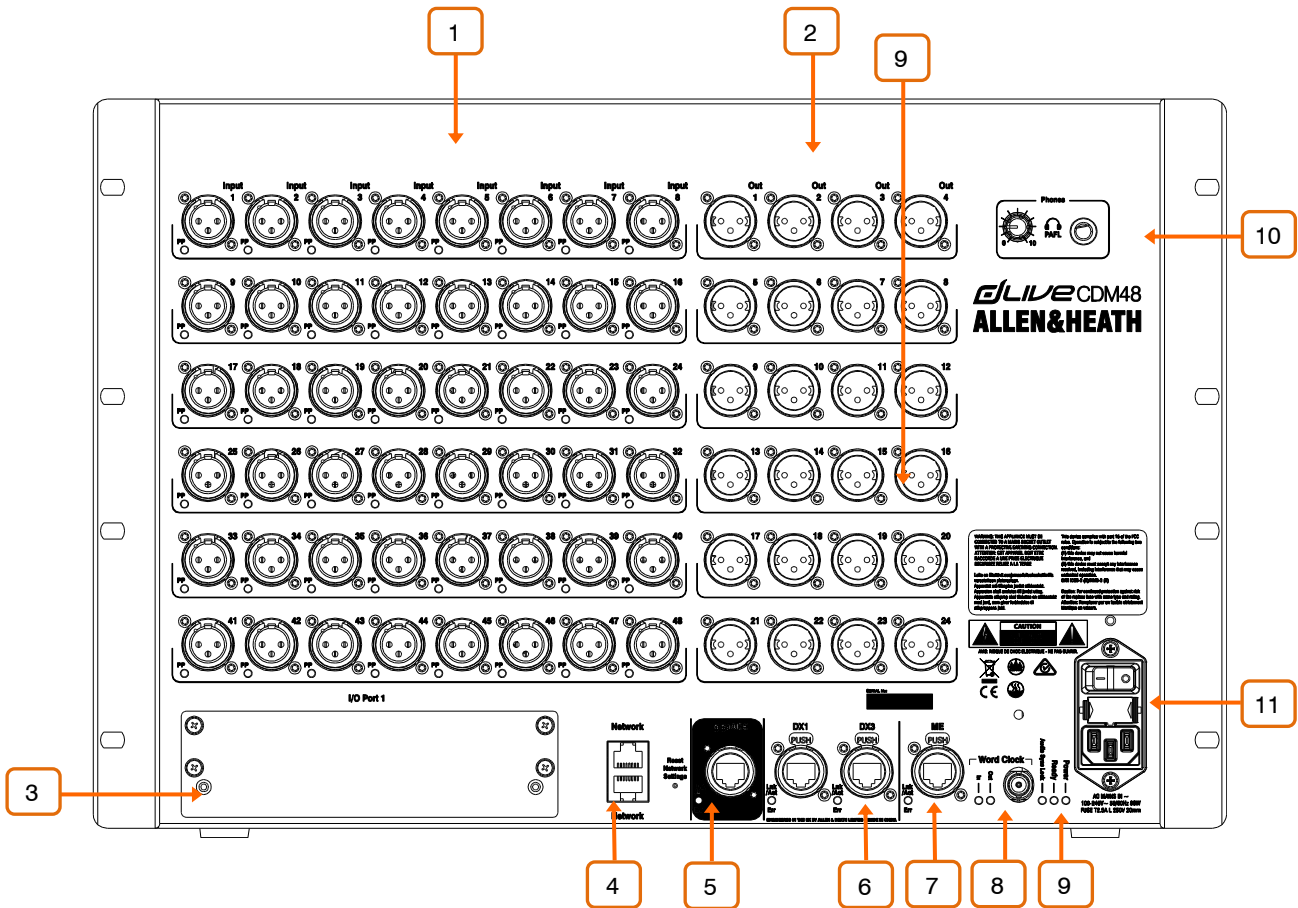

**1 Mic/Line inputs** - Recallable preamps for balanced or unbalanced microphone and line level signals. Gain, Pad and 48V are digitally controlled within the preamp.

The PP indicator lights up when phantom power voltage is detected at the socket, whether internally or externally sourced.

Any socket can be patched to any Input Channel using the **I/O** or **Processing / Preamp** screen.

**2 Line outputs** – Line level, balanced XLR outputs. Nominal level +4dBu. The outputs are relay protected to prevent power on or off thumps.

Signals can be patched to any output socket using the **I/O** screen.

**3 I/O Port** – Audio interface port providing 128x128 channels. Fit one of the option cards available for system expansion, digital mic splitting, recording or distributed audio networking. Refer to [www.allen-heath.com](http://www.allen-heath.com) for a list of available option cards.

**i** iLive / GLD option cards (M-Dante, M-Waves, M-ES-V2, M-ACE, M-MADI) can be used with dLive when fitted with the M-DL-ADAPT ‘letter-box’ adapter. This provides a 64x64 48kHz interface with built-in Sample Rate Conversion.

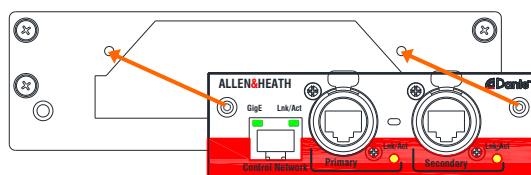

Use the **I/O** screen to patch signals from or to the I/O Port.



**4** **Network** –2x RJ45 Gigabit Ethernet ports. Connect a laptop or a wireless router to use with dLive Editor or iOS apps. All devices on the network must have compatible IP addresses.

**i** A recessed switch lets you reset the network settings to factory default. To reset, turn the MixRack off, insert a pointed object to press and hold the switch whilst turning the MixRack back on. Hold the switch in for at least 20 seconds.

**5** **gigaACE link** – MixRack to Surface link over Gigabit Ethernet (IEEE 802.3 Layer 2 compliant). A single Cat5e (or higher) cable carries bidirectional 96kHz audio and control.

**6** **DX links** – EtherCon ports for connection of up to 2 DX expanders over Fast Ethernet (IEEE 802.3 Layer 2 compliant). A single Cat5e (or higher) cable carries 32x32 channels of 96kHz audio and control. The ports are numbered DX1 and DX3. DX2 and DX4 are dedicated to redundant connections on the dLive DM MixRacks.

Use the **I/O** screen to patch signals from or to the DX expanders.

**7** **ME** - Dedicated EtherCon port for the Allen & Heath ME personal mixing system. A single Cat5e (or higher) carries 40 channels of 48kHz audio, channel names and stereo links. Connect a ME-1 mixer for daisy chaining or ME-U hub for power and audio distribution.

Use the **I/O** screen to patch signals to the ME system.

**8** **Word Clock I/O** - BNC connector for syncing from an external audio clock or providing a clock to other devices. Use the **MixRack / Audio / Audio Sync** screen to select the input or output function and clock source.

**9** **Audio Sync Lock** indicates that the audio is sync locked to a valid clock source. If this does not light up then check that the correct clock source is selected in the **MixRack / Audio / Audio Sync** screen.

**Power** indicates the correct functioning of the PSU.

The **Ready** indicator lights up when the output sockets are ready to pass audio after power up.

**10** **Phones** - Standard 1/4" and 1/8" jack sockets and level control for the built-in headphone amplifier. The output follows the PAFL selection.

**11** **Mains** – IEC socket, On/Off rocker switch and fuse.

A plastic P-clip cable clamp is provided to secure the mains cable. Slot the cable in or lock it in place using a star Torx® T20 screwdriver to refit the clamp around the cable.

## 4. Front Panel

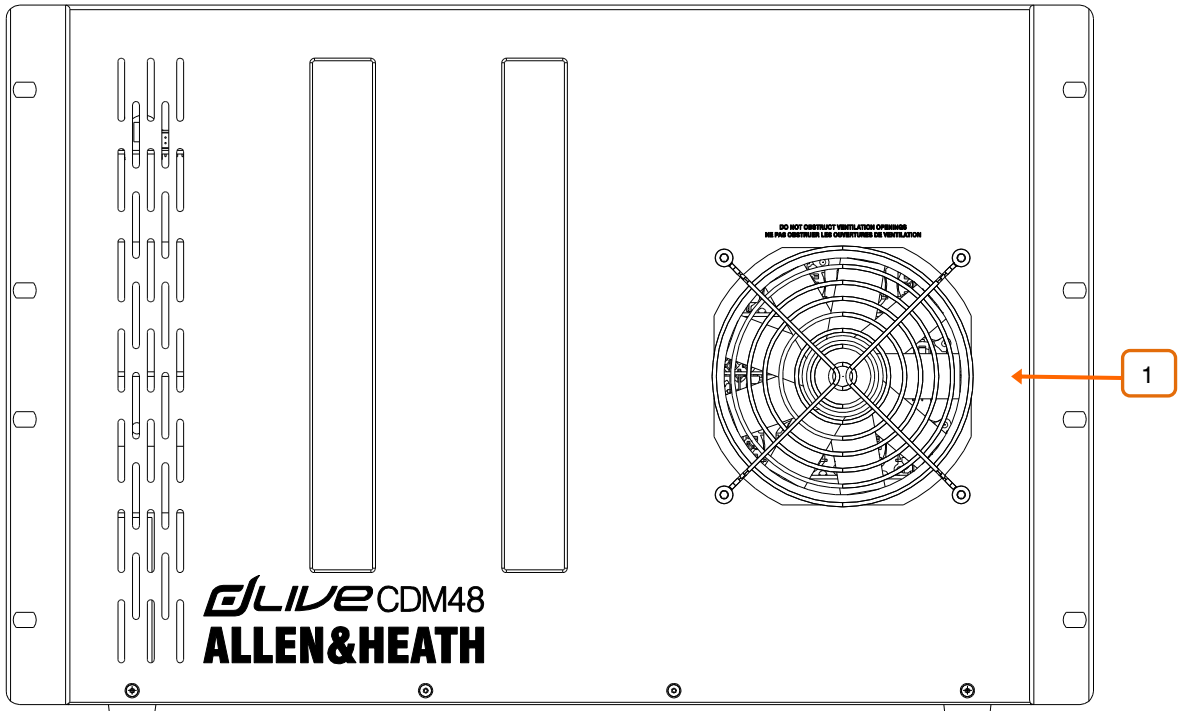

- 1 **Fan** – Ultra-quiet fan. Make sure the ventilation opening is not obstructed.

## 5. Connect and power up

Switch on the MixRack. It takes around 15s for the mix engine to start passing audio. You should hear the relays click as they connect the outputs once the boot-up is completed. The Ready indicator on the front panel will light up at this point.

### 5.1 Surface connection

Plug a touring grade CAT5e (or higher specification) cable up to 100m long between the dLive Surface and MixRack gigaACE port. On an S3000, S5000 or S7000 Surface, use gigaACE port A only.

- ⓘ Refer to [www.allen-heath.com](http://www.allen-heath.com) for cable requirements, recommendations, and a list of CAT5 cables available to order.

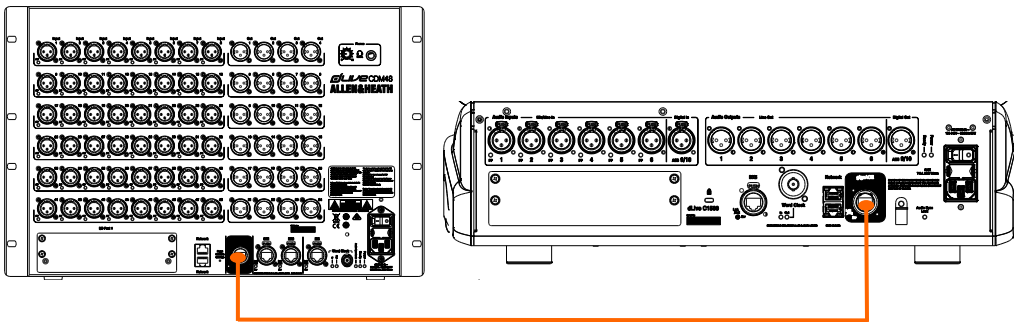

Switch on the Surface. The gigaACE Lnk/Err indicators flash at a steady rate when the link is established. The red error indicator lights if a communication error is detected. Check that the cables are correctly plugged in and are not faulty.

It takes around 30s for the Surface to take control and the touchscreen to be responsive.

### 5.2 Expander connection

Plug a touring grade CAT5e (or higher specification) cable up to 100m long between the DX Expander and MixRack DX port. Use the DX1 port for the first expander, and DX3 port for the second expander.

- ⓘ Do not connect both DX ports to the same DX Expander.
- ⓘ Refer to [www.allen-heath.com](http://www.allen-heath.com) for cable requirements, recommendations, and a list of CAT5 cables available to order.

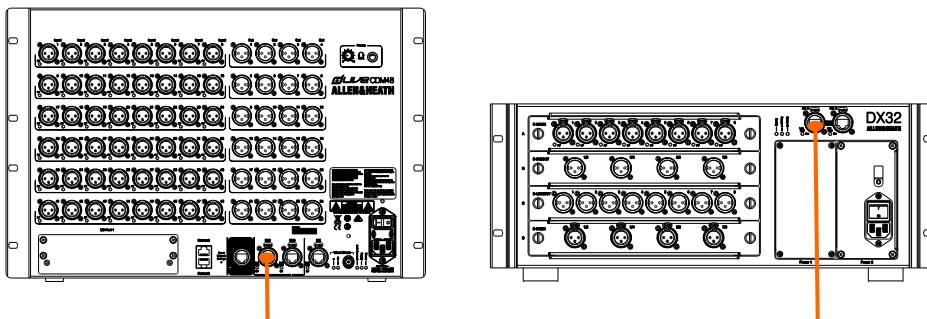

Switch on the DX Expander. The DX port Lnk/Err indicators flash at a steady rate when the link is established. The red error indicator lights if a communication error is detected. Check that the cables are correctly plugged in and are not faulty.

### 5.3 ME system connection

Plug a touring grade CAT5e (or higher specification) cable up to 100m long between the MixRack ME port and the ME-1 or ME-U.

- Refer to [www.allen-heath.com](http://www.allen-heath.com) for cable requirements, recommendations, and a list of CAT5 cables available to order.

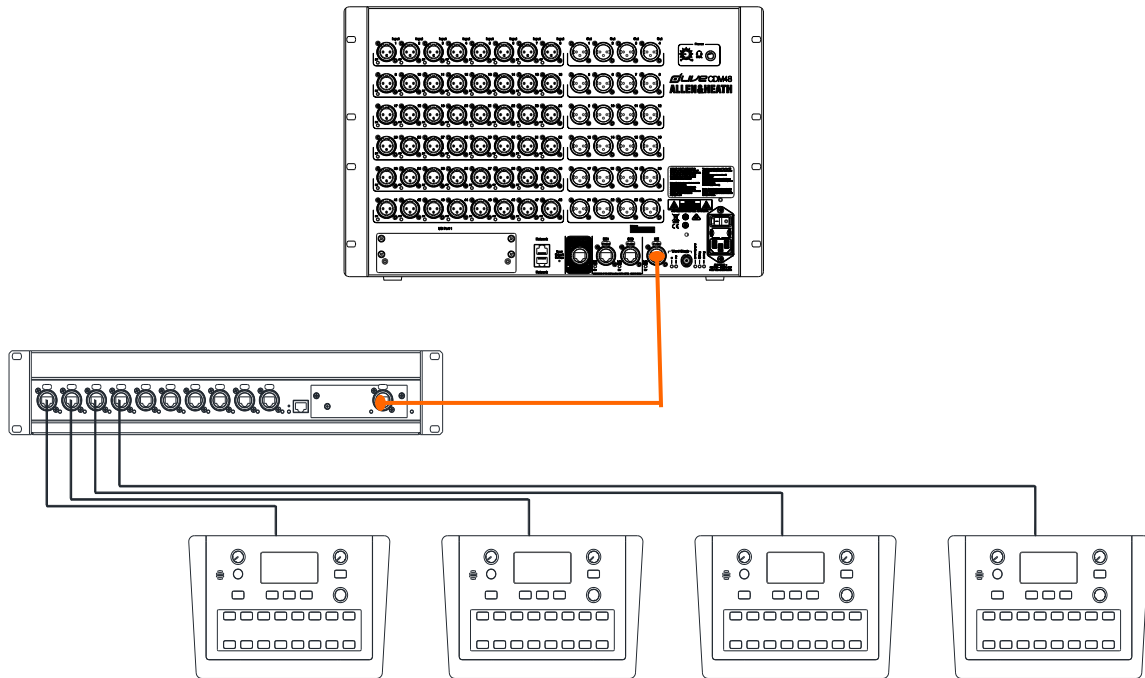

### 5.4 Connect a laptop or wireless router

Connect a laptop, router or access point to either of the Network ports to use with dLive Editor or iOS apps. Read the Release Notes and Help Files accompanying the software or apps for further information.

- dLive communicates over TCP/IP. All devices on the network including the MixRack and Surface must have compatible IP addresses. Factory defaults are:

MixRack	<b>192.168.1.70</b>
Surface	<b>192.168.1.71</b>
Subnet Mask	255.255.255.0
Gateway	192.168.1.254

For direct, wired laptop connections, set your laptop to a static, compatible IP address, for example **192.168.1.10**.

For wireless connections, set your router / access point to a compatible IP address, for example 192.168.1.254, and its DHCP range to a compatible range of addresses, for example **192.168.1.100** to **192.168.1.200**. Set any wireless laptop or mobile device to DHCP / 'obtain an IP address automatically'.

## 6. Dimensions

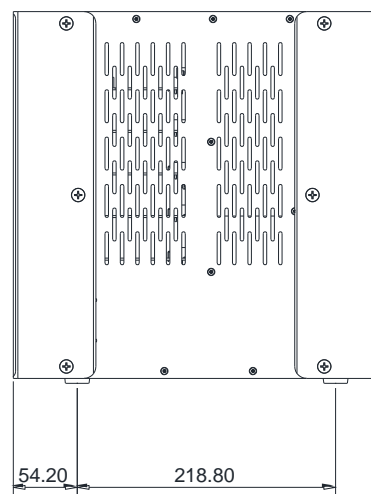
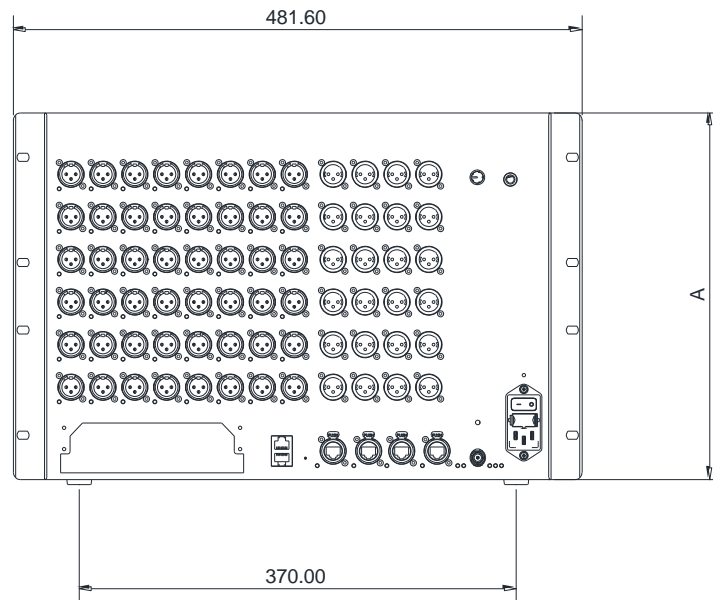
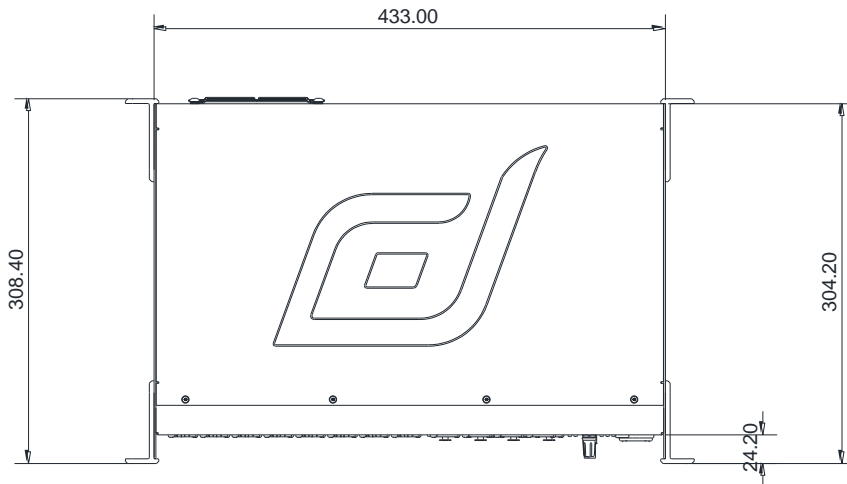

**A**  
 CDM32 - 221mm/8.7"  
 CDM48 - 310mm/12.2"  
 CDM64 - 354.5mm/14"

## 7. Technical specs

### Inputs

<b>Mic/Line XLR Inputs</b>	Balanced XLR, +48V phantom power
Mic/Line Preamp	Fully recallable
Input Sensitivity	-60 to +15dBu
Analogue Gain	+5 to +60dB, 1dB steps
Pad	-20dB Active PAD
Maximum Input Level	+30dBu (PAD in)
Input Impedance	>4k $\Omega$ (Pad out), >10k $\Omega$ (Pad in)
Mic EIN	-127dB with 150 $\Omega$ source
Phantom Power indication	Per socket, internal or external phantom power sensing, triggered at 24V

### System

Measured balanced XLR in to XLR out, 20-20kHz, minimum Gain, Pad out, signal @ 0dB (meter)	
Dynamic Range	110dB
System Signal to Noise	-92dB
Frequency Response	20Hz - 30kHz +0/-0.8dB
THD+N (analogue in to out)	0.0015% @ +16dBu output, 1kHz 0dB gain
Headroom	+18dB
Internal operating Level	0dBu
dBFS Alignment	+18dBu = 0dBFS (+22dBu at XLR output)
Meter Calibration	0dB meter = -18dBFS (+4dBu at XLR out)

### Outputs

<b>Analogue XLR Outputs</b>	Balanced, Relay protected
Output Impedance	<75 $\Omega$
Nominal Output	+4dBu = 0dB meter reading
Maximum Output Level	+22dBu
Residual Output Noise	-92dBu (muted, 20-20kHz)
	-90dBu (muted, 20-40kHz)

Meter Peak indication	-3dBFS (+19dBu at XLR out)
Sampling Rate	96kHz +/- 20 PPM
ADC	24-bit Delta-Sigma
DAC	24-bit Delta-Sigma
Latency	0.7 ms (MixRack XLR in to XLR out, Input to Mix) + 5 samples, Surface to Mixrack (GigaACE hop) + 8 samples, DX32 to Mixrack (DX hop)

### Dimensions and Weights

	Width x Depth x Height x Weight	Operating Temperature Range	0 deg C to 35 deg C (32 deg F to 95 deg F)
CDM32	481.6 x 309 x 221 mm (19"x 12.2"x 8.7") x 10kg (22lbs)	Mains Power	100-240V AC, 50-60Hz, 175W max
CDM48	481.6 x 309 x 310 mm (19"x 12.2"x 12.2") x 12kg (26.4lbs)		
CDM64	481.6 x 309 x 354.5 mm (19"x 12.2"x 14") x 13.5kg (29.7lbs)		

### Boxed

CDM32	600 x 430 x 380 mm (23.7"x 17"x 15") x 12kg (26.5lbs)
CDM48	600 x 430 x 470 mm (23.7"x 17"x 18.5") x 14.5kg (32lbs)
CDM64	600 x 430 x 520 mm (23.7"x 17"x 20.5") x 16.5kg (36.5lbs)