

Sceptre™ S6 / S8

CoActual™ Active Studio Monitors

Owner's Manual

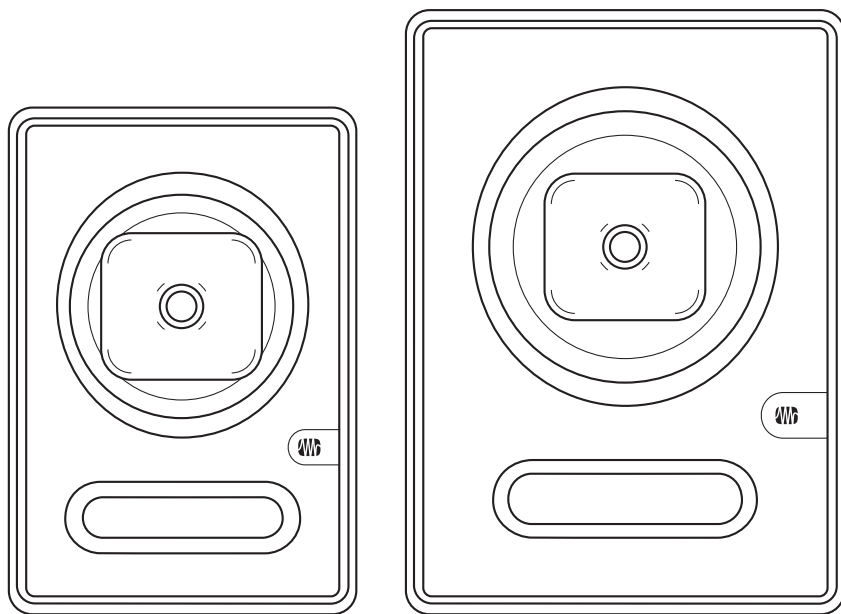

Table of Contents

1.0 Overview — 1

- 1.1 Introduction — 1
- 1.2 Summary of Sceptre S6/S8 Features — 2
- 1.3 What is in the Box — 2
 - 1.3.1 Special Handling Instructions — 2

2 Hookup — 3

- 2.1 Rear Panel Connections and Controls — 3
 - 2.1.1 Inputs — 3
 - 2.1.2 Power — 3
 - 2.1.3 Acoustic Tuning Controls — 4

2.2 Hookup Diagrams — 5

- 2.2.1 Basic Setup — 5
- 2.2.2 Advanced Setup with Speaker Switching — 6

3 Tutorials — 7

- 3.1 Monitor Placement — 7
- 3.2 Connections — 8
- 3.3 Input Level Setting — 8
- 3.4 Equalizer Setting Suggestions — 9
- 3.5 Acoustic Space Setting Suggestions — 10

4 Resources — 11

- 4.1 Technical Specifications — 11
- 4.1 Troubleshooting — 13
- 4.2. PreSonus Limited Warranty — 13

1.0 Overview

1.1 Introduction

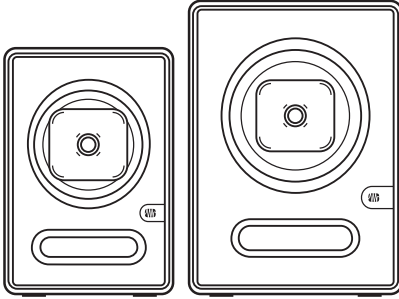

Thank you for purchasing the PreSonus® Sceptre™ S6/S8 CoActual™ active studio monitor. PreSonus Audio Electronics has designed the S6 and S8 utilizing high-grade components to ensure optimum performance that will last a lifetime.

The S6 and S8 self-powered near-field monitors differ in cabinet and driver size, crossover frequency, low-frequency extension, and maximum sound-pressure level; all other specs are

identical. Both models are based on CoActual™ Speaker Coherence Alignment and TQ™ Temporal Equalization Technology from Fulcrum Acoustic. The design starts with a horn-loaded compression tweeter mounted coaxially at the center of a cone woofer to provide true point-source imaging, which is generally considered to be a superior driver configuration, especially for near-field monitoring. Complementing the coaxial drivers is a 32-bit floating-point DSP engine that optimizes the drivers' performance. The result is that you hear every nuance of your mix with astonishing clarity and coherence.

We encourage you to contact us at +1-225-216-7887 (9 a.m. to 5 p.m. Central Time) with questions or comments regarding your PreSonus Sceptre S6/S8. PreSonus Audio Electronics is committed to constant product improvement, and we value your suggestions highly. We believe the best way to achieve our goal of constant product improvement is by listening to the real experts: our valued customers. We appreciate the support you have shown us through the purchase of this product and are confident that you will enjoy your Sceptre S6/S8!

ABOUT THIS MANUAL: *We suggest that you use this manual to familiarize yourself with the features, applications, and correct connection procedures for your Sceptre S6/S8 before connecting it to the rest of your studio gear. This will help you avoid problems during installation and setup.*

In addition to all the basic info you'll need to connect and operate your Sceptre S6/S8, this manual also provides several tutorials that cover monitor placement and connections, as well as how to set the Input Level, EQ, and Acoustic Space controls.

1.2 Summary of Sceptre S6/S8 Features

- Temporal Equalization™ by Fulcrum Acoustic combines 32-bit floating-point DSP with coaxial cone woofer and horn-loaded compression tweeter
- 2x90W, Class D amplifiers optimized for the woofer and tweeter
- Front-ported cabinet extends and smoothes out bass response
- 2 balanced inputs: XLR and ¼"TRS
- Input-level control with 10 dB of gain above unity
- High-frequency driver adjust (linear, +1 dB, -1.5 dB, -4 dB) above 2 kHz
- High-pass filter switch (linear, 60 Hz, 80 Hz, 100 Hz) with -24 dB/octave slope
- Acoustic Space switch (linear, -1.5 dB, -3 dB, -6 dB) to compensate for bass boost near a wall

1.3 What is in the Box

In addition to this manual, your Sceptre S6/S8 package contains the following:

- (1) PreSonus Sceptre S6 **or** S8 active studio monitor

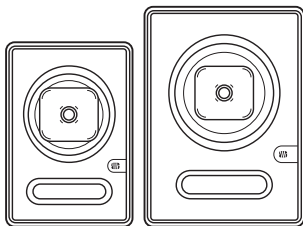

- (1) IEC power cable

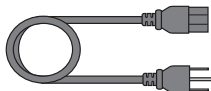

1.3.1 Special Handling Instructions

The horn on your Sceptre S6/S8 is very delicate and should be handled with extreme care. Do not use the horn to turn or adjust your Sceptre S6/S8 or as a handgrip by which to pick it up. Doing so will damage your Sceptre monitor and will require it to be repaired by PreSonus. Damage caused by mishandling may not be covered by your warranty.

2 Hookup

2.1 Rear Panel Connections and Controls

2.1.1 Inputs

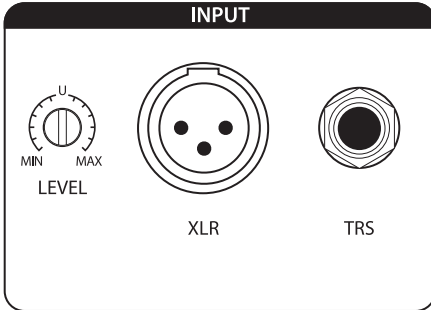

Line-level Inputs. The Sceptre S6/S8 provides a choice of two balanced inputs: XLR and ¼" TRS. These inputs accept a line-level signal from your audio source and feed that signal to the monitor's built-in power amplifiers. When both balanced connections are in use, the TRS input supersedes the XLR input.

Note: Make sure your audio source's XLR or ¼" TRS wiring corresponds to that of the Sceptre S6/S8.



Input Level: Sets the amount of gain applied to the input signal. This is not a volume control in the traditional sense; instead, it sets the level of the input signal before it is amplified.

2.1.2 Power

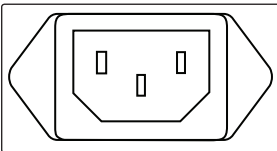

IEC Power Connection: Your Sceptre S6/S8 accepts a standard IEC power cord.

Warning: Do not remove the center grounding prong or use a ground-lift adapter, as this could result in electric shock.

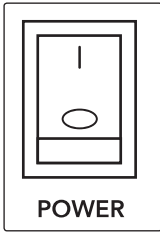

Power Switch: This is the On/Off switch. The power status is indicated by an LED on the front of the cabinet.

Note: *The input-power voltage is set internally at the factory to correspond with the country to which your Sceptre monitor was shipped. Do not use your Sceptre monitor in a country that uses a different standard voltage than is used in the country where you purchased your Sceptre S6 or S8.*

2.1.3 Acoustic Tuning Controls

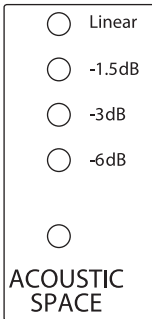

Acoustic Space: Cuts the level of all frequencies below 250 Hz by the specified amount (-1.5, -3, or -6 dB) to compensate for the bass boost that occurs when the monitor is placed near a wall or corner. Can be defeated by setting it to Linear. Repeatedly pushing the corresponding button cycles through the available settings.

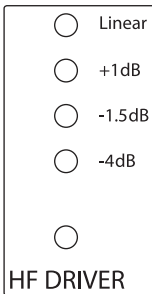

HF Driver: Boosts or cuts all frequencies above 2 kHz by the specified amount (+1, -1.5, or -4 dB). Can be defeated by setting it to Linear. Repeatedly pushing the corresponding button cycles through the available settings.

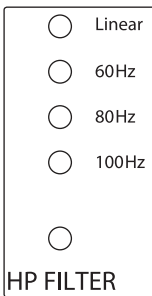

HP Filter: Rolls off the level of all frequencies below the specified frequency (60, 80, or 100 Hz), with a slope of -24 dB/octave. Can be defeated by setting it to Linear, in which case, the monitor's natural rolloff takes over (42 Hz for S6, 38 Hz for S8). Repeatedly pushing the corresponding button cycles through the available settings.

2.2 Hookup Diagrams

2.2.1 Basic Setup

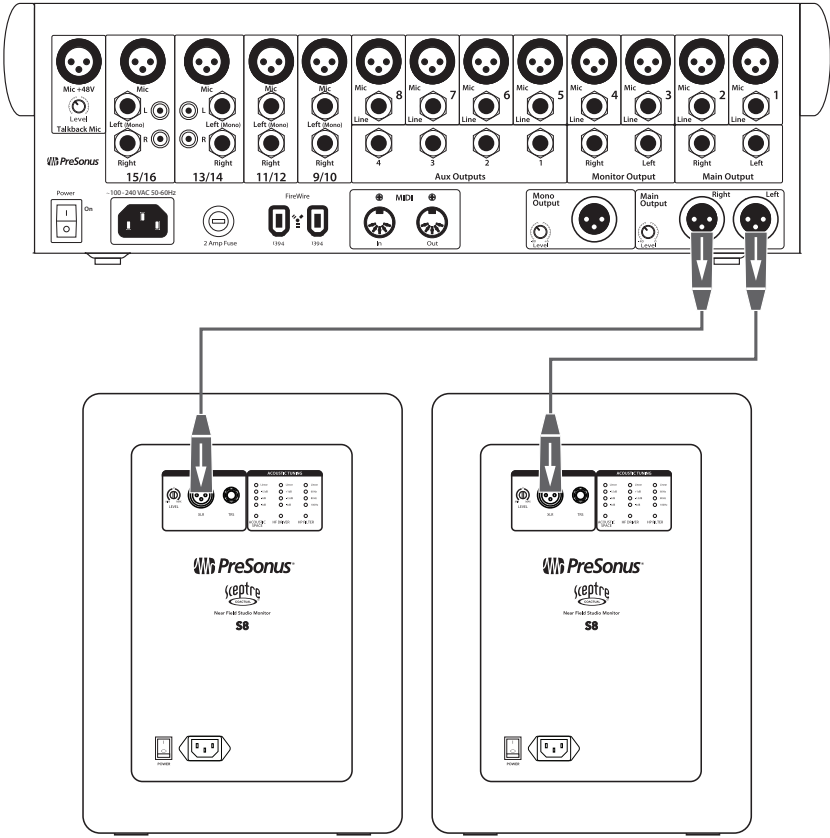

2.2.2 Advanced Setup with Speaker Switching

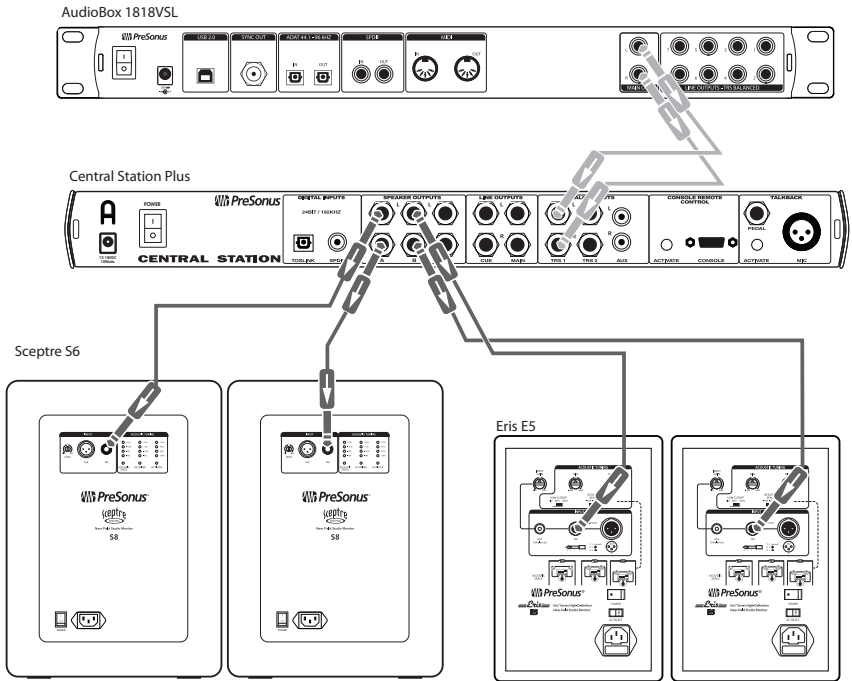

3 Tutorials

3.1 Monitor Placement

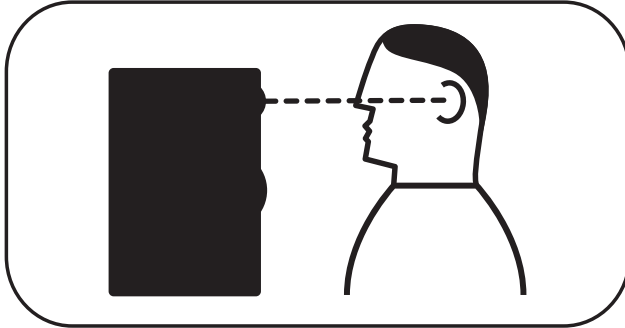

Ideally, near-field monitors should be placed so that the tweeters are at the same height as your ears when you are mixing.

NOTE: *The unique design of the Sceptre monitors requires that they be placed vertically. Positioning Sceptre monitors horizontally will result in incorrect horn dispersion and reduced fidelity.*

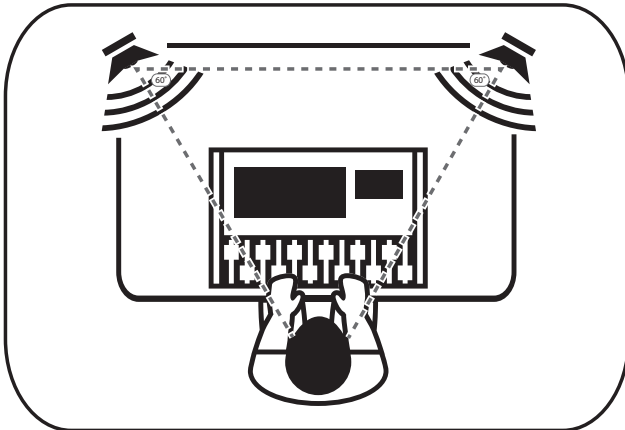

The speakers should be separated so that the coaxial drivers form an equilateral triangle with your head. The monitors should be “toed in,” or angled, so that they are pointed at you, not pointed straight ahead.

3.2 Connections

If your audio source has balanced XLR or ¼"TRS outputs, make sure the wiring of those outputs corresponds with the wiring of the Sceptre S6/S8's inputs as illustrated below. If it doesn't, you'll need "crossover" cables that reverse the two signal conductors.



If your audio source has only unbalanced outputs, connect each of them to a DI (direct-injection) box, which typically has an unbalanced input and a balanced output, and connect the DI box's balanced output to the corresponding input on the Sceptre S6/S8.

In all cases, use the shortest possible cables in order to minimize the chance of picking up electromagnetic or radio-frequency interference (EMI or RFI).

3.3 Input Level Setting

The Input Level control determines the level of the input signal before it is sent to the built-in power amp. This lets you attenuate or amplify the signal's level at the monitor's input, providing the flexibility to adapt to various audio source output levels.

Set the Input Level so that all other level controls in the system needn't be turned way up or way down to achieve a comfortable listening volume. If you set it too low, you'll have to crank your audio source's output level way up, which will increase the audible noise from the source signal. If you set it too high, any noise in the signal will be amplified, which you don't want, either!

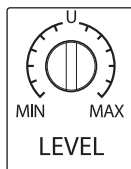

The best place to start is to set the control at its 12 o'clock position, which is labeled "U" for "unity gain." That means the level of the signal reaching the amplifier is the same as the level of the signal entering the monitor's input. This ensures a good, strong signal level without amplifying any noise that might be in the signal. Of course, you should make sure that the gain controls in your audio source have been optimized for maximum signal level and minimum noise. This process is called "gain staging," and you can learn about it from many online sources.

If setting the input gain to Unity is unsatisfactory, you can try different settings, but remember that it's better to avoid settings above U if possible. PreSonus included these settings in case nothing else will work but any noise in the signal will be amplified if the control is set higher than U. On the other hand, if the volume is too loud at unity gain, feel free to turn the Input Level control down a bit—but not so far that you have to crank your audio source's output level to its maximum setting. Again, if you properly gain-stage your audio source, setting Input Level to U or slightly lower should work fine.

Once the monitor's Input Level control is set, leave it alone; don't use it as a system-volume control. Leave that job to the source signal's output-level control.

3.4 Equalizer Setting Suggestions

ACOUSTIC TUNING		
<input type="radio"/> Linear	<input type="radio"/> Linear	<input type="radio"/> Linear
<input type="radio"/> -1.5dB	<input type="radio"/> +1dB	<input type="radio"/> 60Hz
<input type="radio"/> -3dB	<input type="radio"/> -1.5dB	<input type="radio"/> 80Hz
<input type="radio"/> -6dB	<input type="radio"/> -4dB	<input type="radio"/> 100Hz
<input type="radio"/>	<input type="radio"/>	<input type="radio"/>
ACOUSTIC SPACE	HF DRIVER	HP FILTER

The Sceptre S6/S8 provides two EQ controls in its Acoustic Tuning section: HF Driver and HP Filter. (There's also an Acoustic Space control, which is covered in the next section.) The HF Driver control is a high-frequency shelving filter that boosts or cuts all frequencies above 2 kHz by +1 dB, -1.5 dB, or -4 dB. Use this control to fine-tune the reproduction of high frequencies, depending on your room's acoustic characteristics.

In general, setting the HF Driver control to Linear (no boost or cut) will produce the best results. However, if the sound is generally too bright or shrill, try the -1.5 dB setting or, in extreme cases, the -4 dB setting; if the sound is too dull and lifeless, try the +1 dB setting. (In either case, check your source signal's EQ settings to see if anything's amiss.) Keep in mind that the +1 dB setting will also emphasize any high-frequency noise in the signal. It's always better to cut than to boost, if possible, and it's best to use the least cut or boost needed to get the job done.

The HP Filter control rolls off the low frequencies below the specified frequency (60, 80, or 100 Hz) at a slope of -24 dB/octave. Engage this control if you are using a subwoofer in conjunction with the Sceptre S6/S8 monitors, and set it to the same frequency as the crossover to the subwoofer. If you're not using a subwoofer, set the control to Linear.

3.5 Acoustic Space Setting Suggestions

When a monitor is placed close to a wall, or in a corner, the low frequencies tend to be emphasized more than if the monitor is far from any room boundary; this effect is called "boundary bass boost." It is most pronounced if the monitor is in a corner and less pronounced, but still present, if the monitor is near one wall.

To compensate for this bass boost, the Sceptre S6/S8 provides an Acoustic Space switch that cuts all frequencies below 250 Hz by a fixed amount.

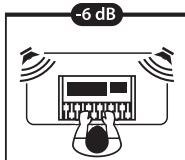

If the monitors are close to the corners of the room, start by setting the Acoustic Space switch to -6 dB, which provides the most bass attenuation.

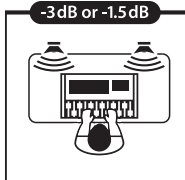

If the monitors are close to the back wall, try setting the Acoustic Space switch to -3 dB or -1.5 dB for less attenuation.

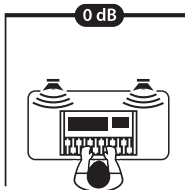

If the monitors are far from any wall, there will be no bass boost, so set the switch to 0 dB.

These are merely starting suggestions; use your ears, experiment, and go with what works best for your listening environment.

4 Resources

4.1 Technical Specifications

INPUTS (S6 and S8)

1- Balanced XLR
1- Balanced ¼" TRS

PERFORMANCE

Frequency Response (-3 dB)

S6	52 Hz – 20 kHz
S8	46 Hz – 20 kHz

Frequency Response (-10 dB)

S6	42 Hz – 23 kHz
S8	38 Hz – 23 kHz

Crossover Frequency

S6	2.2 kHz
S8	2.4 kHz

LF Amplifier Power (@ 4Ω)

S6	90W
S8	90W

HF Amplifier Power (@ 10Ω)

S6	90W
S8	90W

Peak SPL at 1M

S6	109 dB
S8	116 dB

Horn Dispersion

S6 and S8	110° x 90°
-----------	------------

LF Driver

S6	6.5" glass-reinforced paper
S8	8" glass-reinforced paper

HF Driver

S6	1" diaphragm compression driver
S8	1" diaphragm compression driver

Input Impedance

S6	10 kΩ
S8	10 kΩ

USER CONTROLS

Volume Range

S6 and S8	A-type taper
-----------	--------------

HF Control

S6 and S8	Linear, +1, -1.5, -4 dB
-----------	-------------------------

Low Cut

S6 and S8	Linear, 60, 80 Hz, 100 Hz
-----------	---------------------------

Acoustic Space

S6 and S8	Linear, -1.5, -3, -6 dB
-----------	-------------------------

PROTECTION (S6 and S8)

RF interference

Output-current limiting

Over-temperature

Turn-on/off transient

Subsonic filter

Internal mains fuse

POWER

S6 and S8	100-120V ~50/60 Hz or 220-240V ~50/60 Hz
-----------	--

CABINET

S6 and S8	Vinyl-laminated MDF
-----------	---------------------

PHYSICAL

(Width/Height/Depth)

S6	9" (230 mm)/ 11" (280 mm)/ 13.2" (335 mm)
S8	11.4" (290 mm)/ 11.8" (300 mm)/ 15.75" (400 mm)

Weight

S6	18.8 lbs (8.53 kg)
S8	24.25 lbs (11 kg)

4.1 Troubleshooting

No power. First ensure that your Sceptre S6/S8 is plugged in. If it's connected to a power conditioner, verify that the power conditioner is turned on and functioning. If so, yet there is still no power to the monitor, contact PreSonus for a repair.

No audio. If your Sceptre S6/S8 appears to power on but you hear no sound when playing audio from the source signal (the lights are on but nobody's home), first make sure that the cable connecting the source signal to the monitor is working correctly. Also, verify that the Input Gain control is set to provide enough amplitude for the signal.

Hum. Usually, hum is caused by a ground loop. Verify that all audio equipment is connected to the same power source. If you are not using a power conditioner, we highly recommend that you add one. Not only will this help to minimize hum, it will better protect your equipment from power surges, brownouts, etc.

Use balanced cables whenever possible. If your audio device does not offer a balanced output, you can connect it to a DI (direct-injection) box, which will provide a ground-lift switch and a balanced output.

Finally, make sure that your audio cables are not run near power cables, and use cables that are the appropriate length for your application. Using cables that are too long not only increases the risk of noise, it increases the likelihood that the cables are coiled, which will essentially create an antenna that picks up all kinds of audio interference.

4.2. PreSonus Limited Warranty

PreSonus Audio Electronics, Inc., warrants this product to be free of defects in material and workmanship for a period of one year from the date of original retail purchase. This warranty is enforceable only by the original retail purchaser. To be protected by this warranty, the purchaser must complete and return the enclosed warranty card within 14 days of purchase. During the warranty period PreSonus shall, at its sole and absolute option, repair or replace, free of charge, any product that proves to be defective on inspection by PreSonus or its authorized service representative. If you are located in the USA and need warranty repair, please submit an online technical support request at <http://support.presonus.com> to receive a return-authorization number and shipping information. If you are located outside of the USA, please contact the PreSonus

distributor for your region for warranty repairs. All inquiries must be accompanied by a description of the problem. All authorized returns must be sent to the PreSonus repair facility postage prepaid, insured, and properly packaged. PreSonus reserves the right to update any unit returned for repair. PreSonus reserves the right to change or improve the design of the product at any time without prior notice. This warranty does not cover claims for damage due to abuse, neglect, alteration, or attempted repair by unauthorized personnel and is limited to failures arising during normal use that are due to defects in material or workmanship in the product. Any implied warranties, including implied warranties of merchantability and fitness for a particular purpose, are limited in duration to the length of this limited warranty. Some states do not allow limitations on how long an implied warranty lasts, so the above limitation may not apply to you. In no event will PreSonus be liable for incidental, consequential, or other damages resulting from the breach of any express or implied warranty, including, among other things, damage to property, damage based on inconvenience or on loss of use of the product, and, to the extent permitted by law, damages for personal injury. Some states do not allow the exclusion of limitation of incidental or consequential damages, so the above limitation or exclusion may not apply to you. This warranty gives you specific legal rights, and you may also have other rights, which vary from state to state. This warranty only applies to products sold and used in the United States of America. For warranty information in all other countries, please refer to your local distributor.

PreSonus Audio Electronics, Inc.
7257 Florida Blvd.
Baton Rouge, LA 70806 USA
1-225-216-7887
www.presonus.com

Added bonus: PreSonus' previously Top Secret recipe for... **Rice Dressing**

Ingredients:

- 1lb ground beef
- 1 lb chopped chicken liver
- 1 onion (diced)
- 2 green peppers (diced)
- 4-6 celery stalks (diced)
- 2 garlic cloves (minced)
- ¼ C. chopped fresh parsley
- 3 C. chicken stock
- 6 C. cooked rice
- 1 Tbs. oil
- Salt and pepper to taste
- Cayenne pepper to taste

Cooking Instructions:

1. In a large pot, heat oil on medium high and add meat, salt, and pepper to taste. Stir until meat begins to brown.
2. Lower heat and add all vegetables. Cook until onions are transparent and celery is very tender. Add stock as necessary to prevent burning.
3. Stir in cooked rice. Add remaining stock and simmer on low until ready to serve.

© 2013 PreSonus Audio Electronics, Inc. All Rights Reserved. AudioBox, CoActual, DigiMax, Eris, FireStudio, Nimbit, PreSonus, QMix, Riff to Release, Sceptre, StudioLive, and XMAX are trademarks or registered trademarks of PreSonus Audio Electronics, Inc. Capture, Impact, Mixverb Presence, RedLightDist, SampleOne, Studio One, and Tricomp are trademarks or registered trademarks of PreSonus Software Ltd. Mac and Mac OS are registered trademarks of Apple, Inc., in the U.S. and other countries. Windows is a registered trademark of Microsoft, Inc., in the U.S. and other countries. Temporal EQ and TQ are trademarks of Fulcrum Acoustic. Other product names mentioned herein may be trademarks of their respective companies. All specifications subject to change without notice...except the recipe, which is a classic.

