

Radius NX

4x4, 12x8

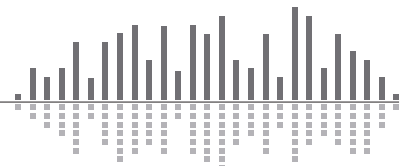

A Giant Leap Forward in Advanced Audio Signal Processing

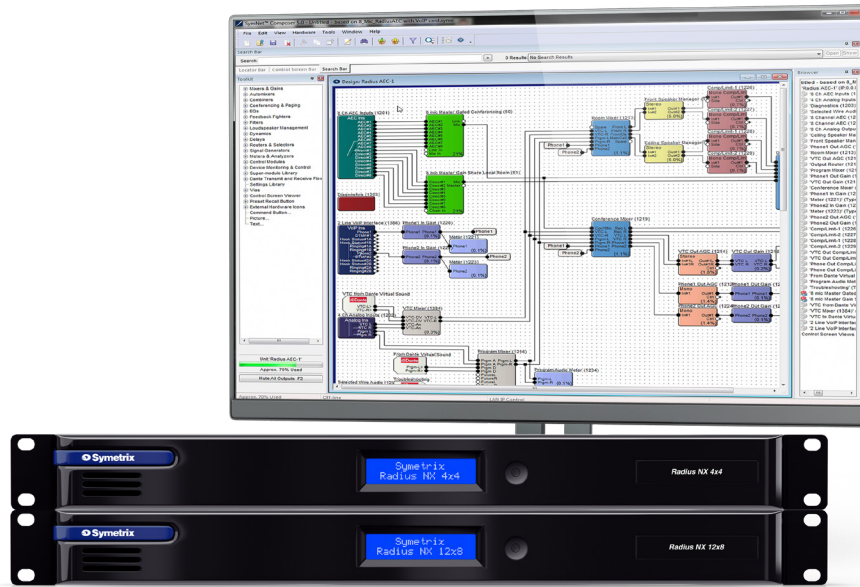
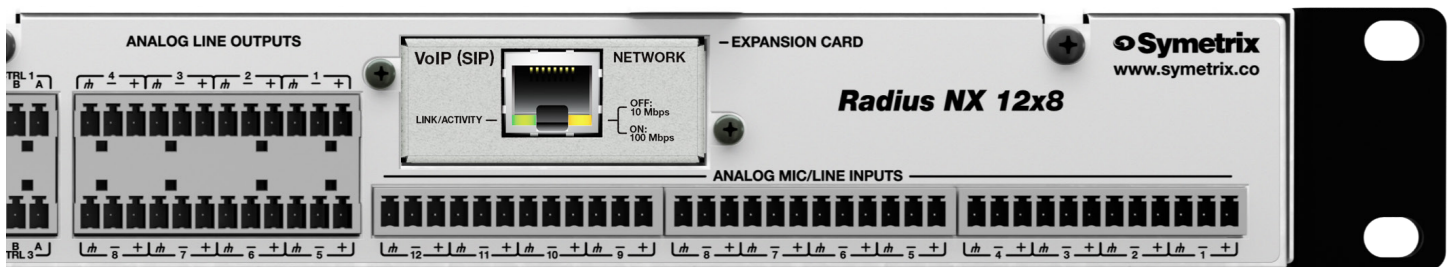

Contents

Radius NX Overview	2	<i>The High Points, The Symetrix Advantage, The Dante™ Story</i>
Radius NX 4x4 Specifications	3-4	<i>Electrical & Mechanical Specs, Architect & Engineer Specs</i>
Radius NX 12x8 Specifications	5-6	<i>Electrical & Mechanical Specs, Architect & Engineer Specs</i>
Radius NX AEC Coprocessor	7	<i>Up to 16 Channels of Wide-band Acoustic Echo Cancelling</i>
Radius NX Input / Output Expansion	8	<i>Expansion Cards, Dante-enabled I/O Expanders</i>
Programming Radius NX	9	<i>Composer™</i>
Controlling Radius NX	10	<i>SymVue, T5, ARC-WEB, ARC Wall Panels, Third-parties</i>

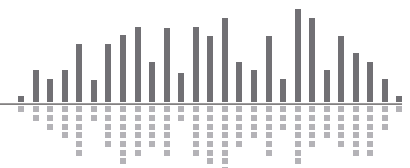

As a core component of network AV systems characterized by flexibility, reliability, and superb sonic performance, Radius NX represents a giant leap forward in advanced audio signal processing.



Radius NX 4x4 and Radius NX 12x8 feature identical DSP resources differing in analog I/O, logic output, and external control input capacity. Radius NX 4x4 has 4 mic/line inputs and 4 outputs. Radius NX 12x8 has 12 mic/line inputs and 8 outputs. Both support 128 (64x64) channels of redundant Dante network audio.

- For conferencing applications, an optional virtualized and scalable **AEC Coprocessor** module provides up to 16 channels of full bandwidth acoustic echo cancelling with unparalleled clarity and intelligibility.
- **A Next-generation SHARC Dual-core Processor** A Next-generation SHARC Dual-core Processor enables a Composer Super Matrix - placing the burden of large matrices in one core while freeing the second core for general purpose signal processing - making it possible to design very large and complex systems around a single Radius NX. View modes make navigating through large matrices a breeze.
- **A Configurable 4-port Gigabit Switch** serves both Dante and control networks. It eliminates or reduces the need for external switches and prevents 100 Mbit bottlenecks.
- **Ultra-low Noise Preamps** with digitally controlled 3dB gain steps contribute to the unmatched sonic superiority Symetrix has always been known for.
- An optional card slot, supporting all currently available Radius and Edge **Expansion Cards**, adds special-purpose functionality and maximizes input or output counts to reduce total system cost.
- When large numbers of analog inputs and outputs are required, Radius NX connects directly to a complete lineup of software-controlled **Dante-enabled Analog I/O Expanders**.

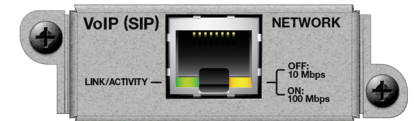
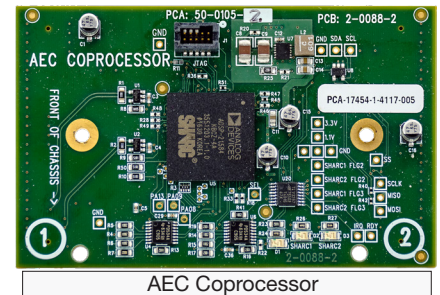

Technical Support and Sales Administration

The Symetrix Advantage. With a singular focus on commercial audio DSP and control, Symetrix delivers cutting edge hardware and software, backed by the highest caliber of customer care. Symetrix continuously expands the scope and capabilities of product offerings to range from simple budget installations to 100,000 seat stadiums, and everything in between. Symetrix leads by innovation, early-stage implementation of Dante™ network audio is just one example.

Continuous improvement programs run deep and wide throughout the organization and manifest in legendary product reliability and long service life. Every aspect of customer success is closely managed under the Symetrix

umbrella: research and development, manufacturing, technical support, and global sales and marketing. Symetrix is customer-centric and nimble delivering responsiveness, ease of doing business, and consistently open communications. Each and every product is meticulously tested to the highest industry standards in a state-of-the-art manufacturing facility near Seattle, WA, USA – and backed by an award winning technical support team.

Dante™ in Our DNA. Radius NX is equipped with 128 (64x64) redundant Dante channels. Dante protocol enables ultra-reliable multi-channel audio networking over IP. Together, Symetrix and Audinate's Dante provide the fastest possible way to implement, control, and maintain a system of networked DSPs and accessories – including third-party Dante-enabled end points.



Symetrix engineers, having worked with Dante for over ten years, leverage the protocol for box-to-box audio networking as well as peer-to-peer connection with major third-parties including *AudioTechnica*, *Clockaudio*, and *Shure*. In countless case studies, designers have benefited from the use of low cost off-the-shelf switches and cabling to link Symetrix DSPs with Dante-enabled mixing consoles, microphones, power amplifiers, loudspeakers, and computers.

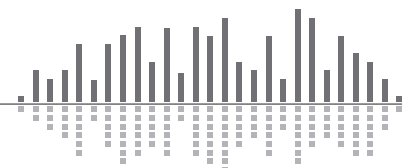

Radius NX 4x4 is an excellent choice in cost-sensitive applications where many Dante network audio endpoints are routed to a primary DSP and fewer analog connections are required. Audio connections include 128 (64x64) channels of redundant Dante, 4 analog mic/line inputs, 4 analog outputs, and up to 8x8 channels of USB audio.

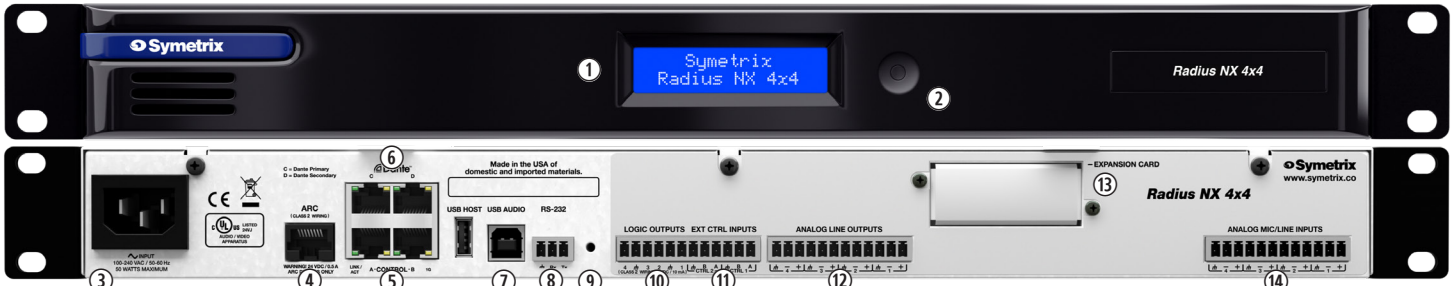

① **Display:** Shows either an overview of system parameters or level meters for analog inputs, analog outputs, USB I/O, and expansion card I/O. The overview contains limited information such as IP Address, DHCP Status, and communication LEDs for Ethernet, Dante, and ARC. A short button press moves between the overview and input/output meters. The meters are scaled from -72 dBFS to 0 dBFS. Each segment represents 12 dB. If the signal reaches clipping, the meter will get wider.

② **Wake / Navigation button:** A single momentary push button is used to cycle through the Dashboard and System Pages or dismiss a fault notification. A short press scrolls through the menus or dismisses a fault notification and a long press toggles between the Dashboard and System Pages.

③ **Power:** Accepts power from detachable IEC power cable (100-240 VAC, 50-60 Hz, 60 Watts max). Connect only to a grounded power outlet.

④ **ARC:** Distributes power and RS-485 data to one or more ARC devices.

⑤ **A & B Ethernet Ports:** 1000 Base-T Ethernet ports for Composer host control, and third-party accessory controllers over IP. Features auto-crossover sensing for direct device-to-device connections.

⑥ **C & D Dante Ports:** 1000 Base-T Ethernet ports provides 128 (64x64) channels of Dante network audio.

⑦ **USB Audio:** A USB 2.0 audio I/O interface with Class 1.0 legacy profiles on a high-retention Type B connection for interfacing with soft codecs, recording and playback software, etc. on Windows, Mac or Linux platforms. Configurable for up to 8x8 line I/O as well as 2x2 line I/O, 1x1 speakerphone, or 1x1 echo cancelling speakerphone profiles.

⑧ **RS-232:** Serial communications interface for a third-party accessory controller. Tx = Transmit or data out, Rx = Receive or data in. Port Settings: 57.6 kbaud (default), 8 data bits, 1 stop bit, no parity, no flow control.

⑨ **Factory Reset Switch:** To be used under the supervision of technical support, it has the ability to reset the unit's network configuration and completely reset the unit to factory defaults.

⑩ **Logic Outputs:** Four (4) logic outputs with four (4) paired common ground pins. Logic Outputs go low (0V) when active and are internally pulled high (5V) when inactive and can drive external LED indicators directly.

⑪ **External Control Inputs:** Two (2) analog control inputs able to be used as 2 potentiometer inputs or as 4 switch inputs (+3.3 VDC reference voltage supplied).

⑫ **Analog Line Outputs:** Four (4) balanced analog line level audio outputs, with individually software-controllable +/- 24 dB of digital trim and mute.

⑬ **Expansion Card Slot:** I/O card slot accepts any of the available cards providing up to 4 channels of local I/O. Please refer to individual I/O card data sheets for details.

⑭ **Analog Mic/Line Inputs:** Four (4) balanced analog audio inputs, with individually software-controllable pre-amp gain, +/- 24 dB of digital trim, phantom power, signal inversion and mute.

System Specifications	
Processor	1 x Analog Devices Griffin ADSP-SC587 dual-core DSP @ 500 MHz
Raw processing capacity	500 MIPS, 6 GFLOPS, 2 GMACS
Sampling Rate	48 kHz, ± 100 ppm.
Frequency response (A/D/A)	20 Hz – 20 kHz, ± 0.5 dB
Dynamic range (A/D/A)	> 114 dB, A-weighted
THD + Noise	< -95 dB (22.4 kHz BW, unweighted); 1 kHz @ +15 dBu with 0 dB gain
Channel separation (A/D/A)	> 110 dB @ 1 kHz, +24 dBu
Latency (A/D/A)	1.04 ms, inputs routed to outputs
Delay memory	174 mono seconds
Analog control inputs	0-3.3 VDC
Recommended external control potentiometer	10k Ohm, linear
Logic outputs	Low (0V) when active, pulled high (5V) when inactive
Logic output maximum external power supply voltage/current sinking	24 VDC / 50 mA
Logic output maximum output current	10 mA
RS-232 accessory serial I/O	57.6 kbaud (default), 8 data bits, 1 stop bit, no parity, no flow control wired straight-through, only pins 2, 3, and 5 required
RS-485 serial I/O	38.4 kbaud (default) 8 data bits, 1 stop bit, no parity, no flow control. May be broken out of ARC port
Ethernet Cable	Standard CAT5/6, maximum device to device length = 328 feet / 100 meters
Dante Cable	Standard CAT6, maximum device to device length = 328 feet / 100 meters
ARC Cable	Standard CAT5/6, distance dependent upon load and number of devices
Maximum stored presets	1000

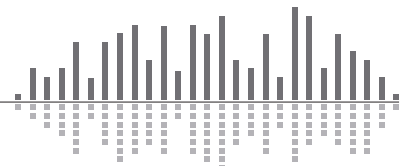

Analog Inputs	
Number of inputs	Four (4) switchable balanced mic or line level
Connectors	3.81 mm terminal blocks
Nominal input level	+4 dBu
Maximum input level	+24 dBu.
Mic pre-amp gain	0 to 51 dB in 3 dB steps with \pm 24 dB digital trim
Mic pre-amp EIN	< -125 dB with 150 Ohm source impedance, 22.4 kHz BW
Input impedance	2k Ohms balanced, 1k Ohms unbalanced
Phantom power (per input)	+48 VDC @ 10 mA maximum
Dynamic range	> 115 dB, A-weighted
THD + Noise	< -100 dB (22.4 kHz BW, unweighted); 1 kHz @ +15 dBu with 0 dB gain.
Latency	0.31 mS

Analog Outputs	
Number of outputs	Four (4) balanced line level
Connectors	3.81 mm terminal blocks
Nominal Output Level	+4 dBu with 20 dB of headroom
Maximum Output Level	+24 dBu (+22.8 dBu into a 2k Ohm minimum load)
Output Impedance	300 Ohms balanced, 150 Ohms unbalanced
Dynamic range	> 117 dB, A-weighted.
THD + Noise	< -97 dB (22.4 kHz BW, unweighted); 1 kHz, 0 dB gain +8 dBu output
Latency	0.65 mS.

USB Audio I/O	
Connector	One (1) high-retention Type B
Interface	2.0 with Audio class 1.0 legacy modes
Capacity	1x1 (echo cancelling speakerphone and non-echo cancelling speakerphone modes) - driverless, 2x2 line I/O mode - driverless, and 8x8 line I/O mode - driver included
Sample Rate	48 kHz
Bit Depth	16-bit, speakerphone modes; 16 or 24-bit, line modes

AEC (if installed)*	
Number of Channels	Up to sixteen (16) for dual-core module (up to 8 references), up to eight (8) for single-core module (up to 4 references)
Tail Length	400mS maximum, dependent on channel and reference count
Convergence Rate	Typically > 90dB/sec
Latency	16 mS
Processors	1 x Analog Devices Griffin ADSP-21584 dual-core DSP @ 500 MHz
Raw processing capacity	500 MIPS, 6 GFLOPS, 2 GMACS
*Optional coprocessor module required, single-core or dual-core models are available.	

Mechanical Data	
Space Required	1U (WDH: 18.91 in. x 9.5 in. x 1.72 in. / 48.02 cm x 24.13 cm x 4.37 cm). Depth does not include connector allowance. Allow at least 3 inches additional clearance for rear panel connections. Additional depth may be required depending upon your specific wiring and connections.
Electrical	100-240 VAC, 50/60 Hz, 60 Watts maximum, universal input.
Ventilation	Maximum recommended ambient operating temperature is 30 C / 86 F. Ensure that the left and right equipment sides are unobstructed (5.08 cm, 2 in. minimum clearance). The ventilation should not be impeded by covering the ventilation openings with items such as newspapers, tablecloths, curtains, etc.
Shipping Weight	13 lbs. (5.9 kg).
Certifications and Compliance	Safety: UL 60065, cUL 60065, IEC 60065 EMC: EN 55103-1, EN 55103-2, EN55032, EN 61000-3-2, EN 61000-3-3, ICES-003, FCC Part 15 (all Class A) Environmental: RoHS

Architect & Engineer Specifications : Symetrix Radius NX 4x4

The device shall provide four analog mic/line inputs that are adjustable from line to mic level with coarse gain, fine trim, phantom power, invert and mute, and four analog line outputs that are adjustable with fine gain and mute. All signal processing, mixing and routing functions (including I/O levels) shall be controllable via software. Audio inputs and outputs shall be accessed via rear panel 3.81 mm terminal block connectors.

An expansion card slot may accommodate either a 2 line VoIP interface card, 2 line analog telephone interface card, 8x8 USB audio I/O card, 4 channel digital input card, 4 channel digital output card, 4 channel mic/line input card, 4 channel AEC input card, 4 channel analog output card, or remain empty.

An internal DSP coprocessor module may be installed for additional application-specific processing such as acoustic echo cancellation (AEC).

A USB 2.0 audio I/O port with class 1.0 legacy modes on a high-retention Type B connection is configurable for up to 8x8 line I/O as well as 2x2 line I/O, 1x1 speakerphone, or 1x1 echo-cancelling speakerphone profiles.

Network audio expansion shall be provided by the Dante protocol with a capacity of 128 (64x64) channels. Primary and Secondary Dante network audio connections shall be provided for redundant network implementation. Connectors shall be 1000 Base-T RJ45 utilizing CAT6 cable.

A designer software application shall be provided that operates on a Windows computer, with network interface installed, running Windows 7® or higher operating system. Computer connection for configuration shall be via the device's rear panel Ethernet connector. All internal processing shall be digital (DSP). Available DSP components shall include (but not be limited to) various forms of: mixers, equalizers, filters, crossovers, dynamics/gain controls, routers, delays, remote controls, meters, generators, onboard logic, and diagnostics.

The front panel shall include a display and a momentary switch. The display shall provide communications and system status, I/O metering, and fault messages.

External control shall include dedicated software screens as well as preset selection, I/O level control and muting using the optional ARC wall panel remote controls via industry-standard CAT5 cable with RJ45 connectors. A built-in web server shall provide four instances of ARC-WEB, which allows for user control from nearly any web browser or mobile device. Logic I/O shall consist of four contact closures or two potentiometer inputs along with four logic outputs. The logic outputs may be used to drive LEDs directly or control external relays or switchers. All program memory shall be non-volatile and provide program security should power fail. The device shall provide an on board real time clock to facilitate automatic, timed changing of presets and may sync to NTP. Third-party control systems may interface over IP and RS-232 using a published ASCII control protocol.

Audio conversion shall be 24-bit, 48 kHz and internal processing shall be 32-bit or 40-bit floating point, 48 kHz. The dynamic range shall not be lower than 115 dB, A-weighted with a maximum input level of +24 dBu and maximum output level of +24 dBu.

The device shall have an IEC power input socket for 120-240 VAC. The device shall meet UL/CSA and CE safety requirements and comply with CE and FCC Part 15 emissions limits. The device shall be RoHS compliant. The chassis shall be constructed of Galvalume and molded plastic, and mount into a standard 19" 1U EIA rack using detachable rack ears. The device shall be a **Symetrix Radius NX 4x4**.

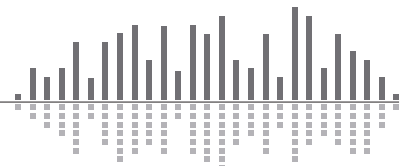

Radius NX 12x8 is best suited for applications requiring a greater compliment of analog input and output channels and/or logic output and external control input capabilities. Audio connections include 128 (64x64) channels of redundant Dante, 12 analog mic/line inputs, 8 analog outputs, and USB audio.



① **Display:** Shows either an overview of system parameters or level meters for analog inputs, analog outputs, USB I/O, and expansion card I/O. The overview contains limited information such as IP Address, DHCP Status, and communication LEDs for Ethernet, Dante, and ARC. A short button press moves between the overview and input/output meters. The meters are scaled from -72 dBFS to 0 dBFS. Each segment represents 12 dB. If the signal reaches clipping, the meter will get wider.

② **Wake / Navigation button:** A single momentary push button is used to cycle through the Dashboard and System Pages or dismiss a fault notification. A short press scrolls through the menus or dismisses a fault notification and a long press toggles between the Dashboard and System Pages.

③ **Power:** Accepts power from detachable IEC power cable (100-240 VAC, 50-60 Hz, 60 Watts max). Connect only to a grounded power outlet.

④ **ARC:** Distributes power and RS-485 data to one or more ARC devices.

⑤ **A & B Ethernet Ports:** 1000 Base-T Ethernet ports for Composer host control, and third-party accessory controllers over IP. Features auto-crossover sensing for direct device-to-device connections.

⑥ **C & D Dante Ports:** 1000 Base-T Ethernet ports provides 128 (64x64) channels of Dante network audio.

⑦ **USB Audio:** A USB 2.0 audio I/O interface with Class 1.0 legacy profiles on a high-retention Type B connection for interfacing with soft codecs, recording and playback software, etc. on Windows, Mac or Linux platforms. Configurable for up to 8x8 line I/O as well as 2x2 line I/O, 1x1 speakerphone, or 1x1 echo cancelling speakerphone profiles.

⑧ **RS-232:** Serial communications interface for a third-party accessory controller. Tx = Transmit or data out, Rx = Receive or data in. Port Settings: 57.6 kbaud (default), 8 data bits, 1 stop bit, no parity, no flow control.

⑨ **Factory Reset Switch:** To be used under the supervision of technical support, it has the ability to reset the unit's network configuration and completely reset the unit to factory defaults.

⑩ **Logic Outputs:** Eight (8) logic outputs with four (4) paired common ground pins. Logic Outputs go low (0V) when active and are internally pulled high (5V) when inactive and can drive external LED indicators directly.

⑪ **External Control Inputs:** Four (4) analog control inputs able to be used as 4 potentiometer inputs or as 8 switch inputs (+3.3 VDC reference voltage supplied).

⑫ **Analog Line Outputs:** Eight (8) balanced analog line level audio outputs, with individually software-controllable +/- 24 dB of digital trim and mute.

⑬ **Expansion Card Slot:** I/O card slot accepts any of the available cards providing up to 4 channels of local I/O. Please refer to individual I/O card data sheets for details.

⑭ **Analog Mic/Line Inputs:** Twelve (12) balanced analog audio inputs, with individually software-controllable pre-amp gain, +/- 24 dB of digital trim, phantom power, signal inversion and mute.

System Specifications	
Processor	1 x Analog Devices Griffin ADSP-SC587 dual-core DSP @ 500 MHz
Raw processing capacity	500 MIPS, 6 GFLOPS, 2 GMACS
Sampling Rate	48 kHz, ± 100 ppm.
Frequency response (A/D/A)	20 Hz – 20 kHz, ± 0.5 dB
Dynamic range (A/D/A)	> 114 dB, A-weighted
THD + Noise	< -95 dB (22.4 kHz BW, unweighted); 1 kHz @ +15 dBu with 0 dB gain
Channel separation (A/D/A)	> 110 dB @ 1 kHz, +24 dBu
Latency (A/D/A)	1.04 ms, inputs routed to outputs
Delay memory	174 mono seconds
Analog control inputs	0-3.3 VDC
Recommended external control potentiometer	10k Ohm, linear
Logic outputs	Low (0V) when active, pulled high (5V) when inactive
Logic output maximum external power supply voltage/current sinking	24 VDC / 50 mA
Logic output maximum output current	10 mA
RS-232 accessory serial I/O	57.6 kbaud (default), 8 data bits, 1 stop bit, no parity, no flow control wired straight-through, only pins 2, 3, and 5 required
RS-485 serial I/O	38.4 kbaud (default) 8 data bits, 1 stop bit, no parity, no flow control. May be broken out of ARC port
Ethernet Cable	Standard CAT5/6, maximum device to device length = 328 feet / 100 meters
Dante Cable	Standard CAT6, maximum device to device length = 328 feet / 100 meters
ARC Cable	Standard CAT5/6, distance dependent upon load and number of devices
Maximum stored presets	1000

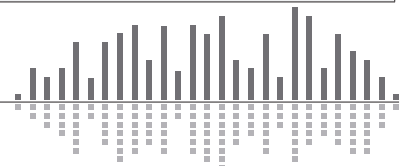

Analog Inputs	
Number of inputs	Twelve (12) switchable balanced mic or line level
Connectors	3.81 mm terminal blocks
Nominal input level	+4 dBu
Maximum input level	+24 dBu.
Mic pre-amp gain	0 to 51 dB in 3 dB steps with \pm 24 dB digital trim
Mic pre-amp EIN	< -125 dB with 150 Ohm source impedance, 22.4 kHz BW
Input impedance	2k Ohms balanced, 1k Ohms unbalanced
Phantom power (per input)	+48 VDC @ 10 mA maximum
Dynamic range	> 115 dB, A-weighted
THD + Noise	< -100 dB (22.4 kHz BW, unweighted); 1 kHz @ +15 dBu with 0 dB gain.
Latency	0.31 mS

Analog Outputs	
Number of outputs	Eight (8) balanced line level
Connectors	3.81 mm terminal blocks
Nominal Output Level	+4 dBu with 20 dB of headroom
Maximum Output Level	+24 dBu (+22.8 dBu into a 2k Ohm minimum load)
Output Impedance	300 Ohms balanced, 150 Ohms unbalanced
Dynamic range	> 117 dB, A-weighted.
THD + Noise	< -97 dB (22.4 kHz BW, unweighted); 1 kHz, 0 dB gain +8 dBu output
Latency	0.65 mS.

USB Audio I/O	
Connector	One (1) high-retention Type B
Interface	2.0 with Audio class 1.0 legacy modes
Capacity	1x1 (echo cancelling speakerphone and non-echo cancelling speakerphone modes) - driverless, 2x2 line I/O mode - driverless, and 8x8 line I/O mode - driver included
Sample Rate	48 kHz
Bit Depth	16-bit, speakerphone modes; 16 or 24-bit, line modes

AEC (if installed)*	
Number of Channels	Up to sixteen (16) for dual-core module (up to 8 references), up to eight (8) for single-core module (up to 4 references)
Tail Length	400mS maximum, dependent on channel and reference count
Convergence Rate	Typically > 90dB/sec
Latency	16 mS
Processors	1 x Analog Devices Griffin ADSP-21584 dual-core DSP @ 500 MHz
Raw processing capacity	500 MIPS, 6 GFLOPS, 2 GMACS
*Optional coprocessor module required, single-core or dual-core models are available.	

Mechanical Data	
Space Required	1U (WDH: 18.91 in. x 9.5 in. x 1.72 in. / 48.02 cm x 24.13 cm x 4.37 cm). Depth does not include connector allowance. Allow at least 3 inches additional clearance for rear panel connections. Additional depth may be required depending upon your specific wiring and connections.
Electrical	100-240 VAC, 50/60 Hz, 60 Watts maximum, universal input.
Ventilation	Maximum recommended ambient operating temperature is 30 C / 86 F. Ensure that the left and right equipment sides are unobstructed (5.08 cm, 2 in. minimum clearance). The ventilation should not be impeded by covering the ventilation openings with items such as newspapers, tablecloths, curtains, etc.
Shipping Weight	13 lbs. (5.9 kg).
Certifications and Compliance	Safety: UL 60065, cUL 60065, IEC 60065 EMC: EN 55103-1, EN 55103-2, EN55032, EN 61000-3-2, EN 61000-3-3, ICES-003, FCC Part 15 (all Class A) Environmental: RoHS

Architect & Engineer Specifications : Symetrix Radius NX 12x8

The device shall provide twelve analog mic/line inputs that are adjustable from line to mic level with coarse gain, fine trim, phantom power, invert and mute, and 8 analog line outputs that are adjustable with fine gain and mute. All signal processing, mixing and routing functions (including I/O levels) shall be controllable via software. Audio inputs and outputs shall be accessed via rear panel 3.81 mm terminal block connectors.

An option card slot may accommodate either a 2 line VoIP interface card, 2 line analog telephone interface card, 4 channel digital input card, 4 channel digital output card, 4 channel mic/line input card, 4 channel AEC input card, 4 channel analog output card, 8x8 USB audio I/O card, or remain empty.

An internal DSP coprocessor module may be installed for additional application-specific processing such as acoustic echo cancellation (AEC).

A USB 2.0 audio I/O port with class 1.0 legacy modes on a high-retention Type B connection is configurable for up to 8x8 line I/O as well as 2x2 line I/O, 1x1 speakerphone, or 1x1 echo-cancelling speakerphone profiles.

Network audio expansion shall be provided by the Dante protocol with a capacity of 128 (64x64) channels. Primary and Secondary Dante network audio connections shall be provided for redundant network implementation. Connectors shall be 1000 Base-T RJ45 utilizing CAT6 cable.

A designer software application shall be provided that operates on a Windows computer, with network interface installed, running Windows 7® or higher operating system. Computer connection for configuration shall be via the device's rear panel Ethernet connector. All internal processing shall be digital (DSP). Available DSP components shall include (but not be limited to) various forms of: mixers, equalizers, filters, crossovers, dynamics/gain controls, routers, delays, remote controls, meters, generators, onboard logic, and diagnostics.

The front panel shall include a display and a momentary switch. The display shall provide communications and system status, I/O metering, and fault messages.

External control shall include dedicated software screens as well as preset selection, I/O level control and muting using the optional ARC wall panel remote controls via industry-standard CAT5 cable with RJ45 connectors. A built-in web server shall provide four instances of ARC-WEB, which allows for user control from nearly any web browser or mobile device. Logic I/O shall consist of eight contact closures or four potentiometer inputs along with eight logic outputs. The logic outputs may be used to drive LEDs directly or control external relays or switchers. All program memory shall be non-volatile and provide program security should power fail. The device shall provide an on board real time clock to facilitate automatic, timed changing of presets and may sync to NTP. Third-party control systems may interface over IP and RS-232 using a published ASCII control protocol.

Audio conversion shall be 24-bit, 48 kHz and internal processing shall be 32-bit or 40-bit floating point, 48 kHz. The dynamic range shall not be lower than 115 dB, A-weighted with a maximum input level of +24 dBu and maximum output level of +24 dBu.

The device shall have an IEC power input socket for 120-240 VAC. The device shall meet UL/CSA and CE safety requirements and comply with CE and FCC Part 15 emissions limits. The device shall be RoHS compliant. The chassis shall be constructed of Galvalume and molded plastic, and mount into a standard 19" 1U EIA rack using detachable rack ears. The device shall be a **Symetrix Radius NX 12x8**.

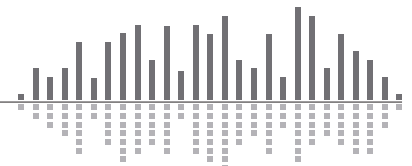

Adding a Radius NX AEC Coprocessor to Radius NX 4x4 or Radius NX 12x8 systems promotes the highest possible levels of clarity and intelligibility in AV conferencing and distance learning applications. System programmers optimize design performance and resource utilization by matching the number of AEC channels, number of references, and tail length to their specific requirements.

The coprocessor is available in single and dual core versions. Each core corresponds to a single AEC module in Composer providing up to 8 channels with a single reference or up to 4 channels with independent references for each channel.

Features and Benefits	
Wideband AEC	Optimizes far-end intelligibility
Up to 400ms tail length	Enhanced performance in large, reverberant spaces
Adjustable background noise reduction	Optimizes far-end intelligibility in noisy spaces
Virtual, assignable, routable channels	AEC can be applied to any sources within a system and routed to any destinations
Ultra-fast convergence rate	Enhanced performance at onset of conversations and when roving microphones are in use
Highly stable adaptive filtering	No divergence during long periods of double-talk
Frequency domain NLP	Lowers far-end distortion by only removing offending spectral content
Comfort noise	Adaptively matched to natural room tone giving participants an indication that the communications channel is still active during periods of silence

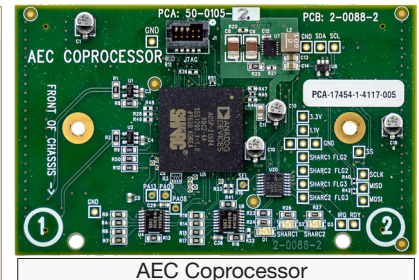
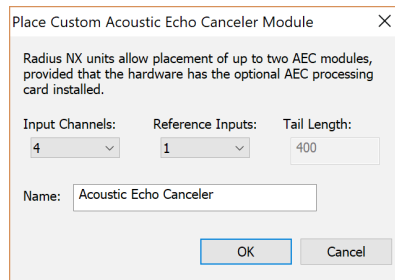

Specifications	
Sample Rate	48 kHz
Bandwidth (Frequency Response)	20-20 kHz
Latency	16 ms
Tail Length	400 ms, maximum
Convergence Rate	Typically > 90dB/sec
Single Talk Total Cancellation	80dB, typical
Double Talk Total Cancellation	40dB, typical
NR (Background Noise Reduction)	User adjustable, up to 25dB
Standards Compliance	ITU G.167, ITU G.340, VDA Category 1
AEC Channels per Core	User selectable, up to 8
Reference Inputs per Core	User selectable, up to 4

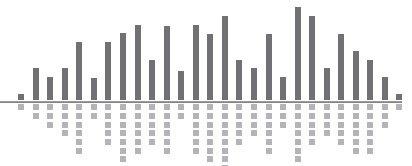
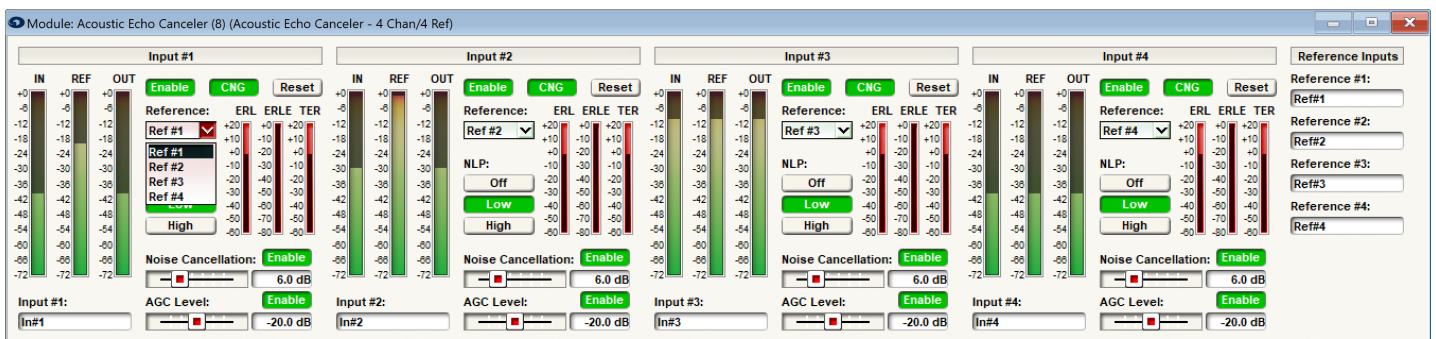
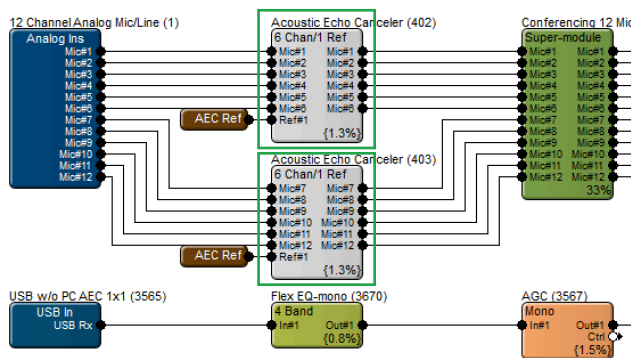

Expansion Cards increase analog and digital I/O capacity and add special purpose functionality to Radius NX DSPs.

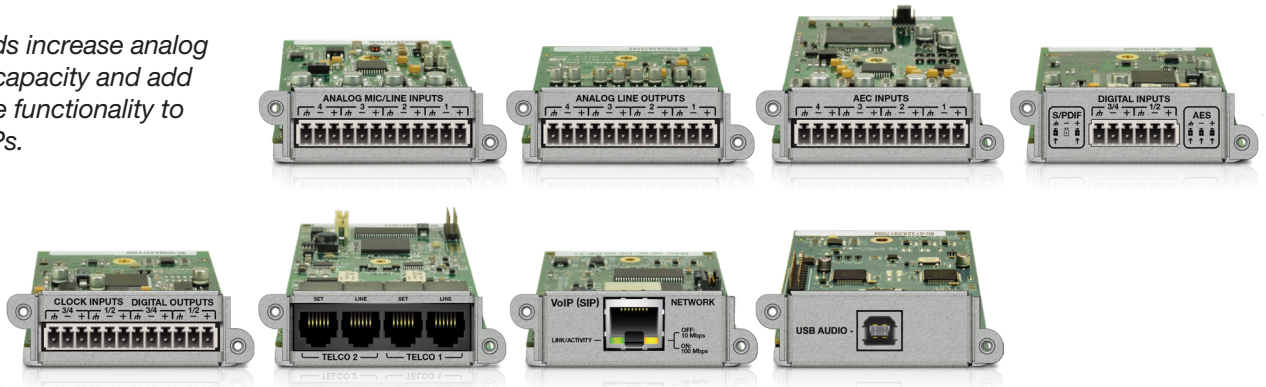

- **4 Channel Analog Input Card** provides four channels of mic/line input with +48 volts phantom power, 54 dB of gain and 24 dB of trim.
- **2 Line VoIP Interface Card** is well suited for applications in conferencing, paging, remote monitoring, and broadcast.
- **2 Line Analog Telephone Interface Card** supports a complete set of PSTN telephony functions. Telco connections are provided on RJ11 ports for easy connection.
- **4 Channel Analog Output Card** provides four channels of line level output. The outputs are electronically balanced and provided on plug-in barrier strip connectors.
- **4 Channel AEC Input Card** provides transparent acoustic echo cancellation with tail lengths up to 250 mS, convergence times greater than 60 dB/S, and an industry low latency of 16 mS
- **4 Channel Digital Input Card** provides four channels of digital input in AES or S/PDIF format and 24 dB of trim. Control of each input includes metering, trim, mute and signal inversion.
- **4 Channel Digital Output Card** provides four channels of digital output in AES or S/PDIF format with clock inputs to sync to an external sample rate. Control of each output includes gain with metering and mute.
- **USB Audio Card** provides integration with courtroom systems, soft codec, and cloud conferencing platforms, and multi-track recording software.

Dante-enabled Analog I/O Expanders are a low cost way to add as many analog input or output channels as needed to Radius NX based systems. Setup using Composer software is virtual, as there are no mechanical switches, potentiometers or circuit board jumpers.

xIn 4 | xOut 4 | xIO 4x4

- 1/2 rack form factor.
- PoE – injectors included.
- xIn 4 – 4 mic/line inputs.
- xIO 4x4 – 4 mic/line inputs, 4 outputs.
- xOut 4 – 4 outputs.
- Optional rack and surface mounting kits sold separately.



xIn 12 | xOut 12

- 1U 19" rack mount.
- Internal power supplies.
- Built-in network switches.
- xIn 12 – 12 mic/line inputs.
- xOut 12 – 12 outputs.
- Front panel signal level indicators

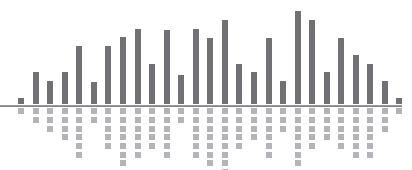

Composer is the Windows® application used to program Radius NX. In addition to comprehensive DSP configuration and Dante routing, Composer is used to set up Symetrix Dante-enabled Analog I/O Expanders and select third-party Dante audio and video endpoints. With Composer, integrators design sophisticated systems, end-to-end, using a single powerful application.

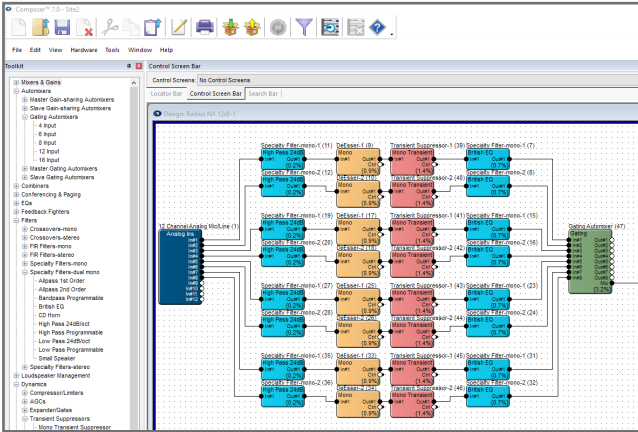

Open-architecture Means Infinite Possibilities. With Composer, choices of signal routings, DSP modules, and control signal processing are at the sole discretion of the programmer. This enables each and every system to perfectly align with specifications as well as to adapt and expand as requirements change. All classes of audio processing modules are provided including mixers, automixers, matrices, equalizers, filters, compressor/limiters, automatic gain controller (AGC), automatic ambient sound pressure level response (SPL Computer), and Feedback Fighter. Application-specific modules such as room combiners directly address complex and often challenging integration issues. Specialized processes like Acoustic Echo Cancellation (AEC) enhance intelligibility and make possible seamless multi-point conferencing.

Composer's **Dante** tools provide integrators with network audio connectivity that is flexible, dependable, scalable, and supportable. In short, just what you'd expect from a defacto industry standard and just what you'd expect from Symetrix. Dante network routings can be established and maintained natively from within Composer, meaning there is typically no need to use multiple software applications to manage Dante.

Radius, Edge, and Prism DSPs are Dante DDM ready. Dante Domain Manager is network management software that enables user authentication, role-based security and audit capabilities for Dante networks. DDM brings IT best practices to AV, making audio networking more secure, more scalable, and more controllable.

As Audinate's DDM develops and matures, so does Symetrix' support of this important forefront of network AV security technology.

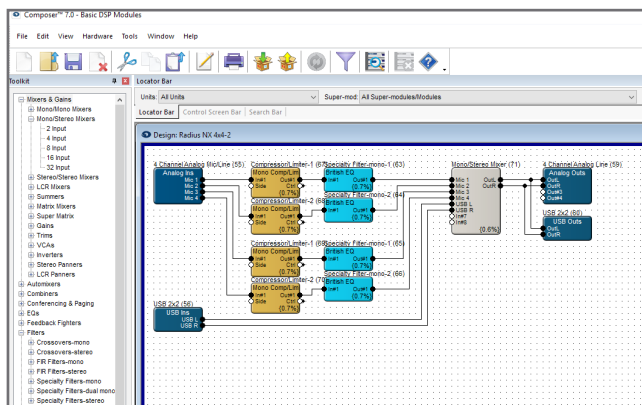
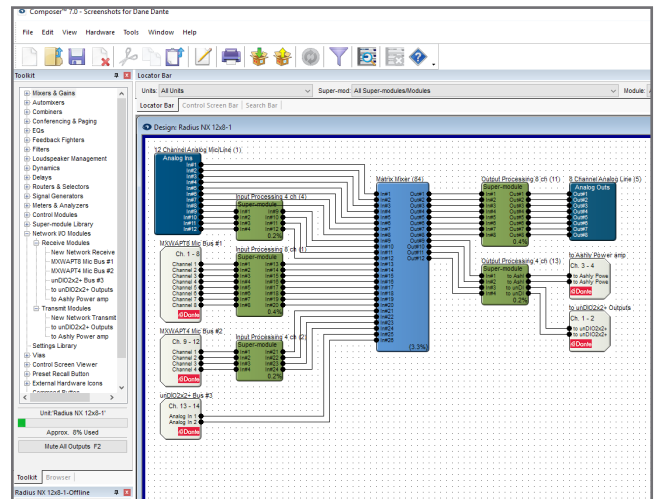

Composer's **Control Modules** can be assembled in various combinations to elegantly overcome application challenges often encountered in system designs. Control Modules include gates (AND, OR, XOR), flip-flops, binary encoders/decoders, multiplexers, and delays. Logic chains may be driven by internal audio or logic signals, Radius NX's External Control Inputs, by third-party RS-232, or IP devices. Logic chains can be used to trigger other internal logic functions, recall presets, drive general purpose outputs, or send strings via RS-232, UDP/IP or TCP/IP for control of external devices such as video screens and lighting. The possibilities are many and varied.

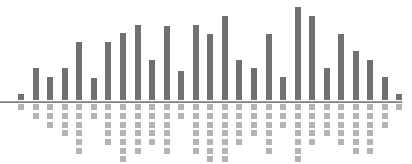

There are many ways to control Radius NX. Symetrix continuously expands the scope of options ranging from basic low-cost wall panels to sophisticated fully customizable touchscreens.

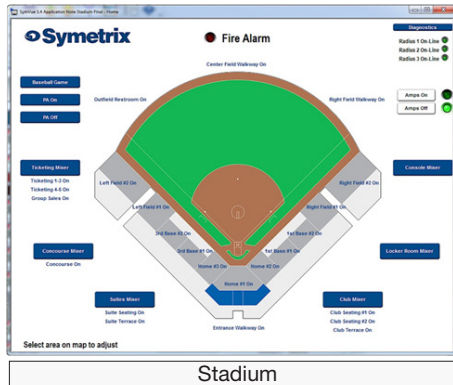

Stadium

SymVue Control Screen Software - Composer's SymVue export feature brings user control GUIs to life in minutes – not days. Commonly adjusted control objects, indicators, and labels are chosen and configured into sets of attractive, easily accessible and familiar screens - created and tested offline without any script or code writing.

Composer-generated SymVue files run on three hardware platforms: Symetrix Control Server, Symetrix touchscreen control panels, and Microsoft Windows computers/tablets. Virtually any HTML browser-enabled device (an Apple iPad, for example) can connect to Control Server and provide multi-touch control of Symetrix DSPs and select third party audio and video hardware. SymVue works alongside Symetrix ARC Wall Panels, ARC-WEB, and 3rd party controllers. All parameter changes and indicators are always kept in perfect synchronization.

SymVue running on **Control Server** hardware enables robust deployment and maintenance of large scale systems by supporting numerous and diverse browser-based endpoints under the control of multiple simultaneous users.

Control Server's Gigabit Ethernet port connects to A/V or general purpose facility networks and to networked DSPs. Operating in wireless mode, Control Server is a Wi-Fi access point providing mobile device connectivity – in essence a secure "AV control island".



Control Server



T5 Touchscreen

T5 touchscreen controller features a capacitive touch full color hi-res LCD. The 5" (12.7cm) screen is bright, responsive, and easy to read from all angles.

GUI layout and control elements are completely customizable to provide end users the exact controls and labels they desire.

T5 is programmed from Composer with no need for script writing or coding. There are no software licensing fees. Logos and other graphical elements may be imported in .jpg, .png, .gif, and .bmp formats.

Universal mounting hardware is supplied for landscape mounting in US/ EU and British Standard wall and junction boxes. T5 is powered via PoE.

ARC-WEB is the simplest way to control Radius NX from phones, tablets and computers. ARC-WEB is royalty and license free. It runs on Radius NX's embedded web server. Connect Radius NX to a Wi-Fi access point and then, using any browser-based computing device, presets, volume, mute, source selection and other parameters are at your fingertips.

ARC-WEB is flexible and secure featuring four separate instances. Each of four users can be assigned unique privileges and security.



ARC-WEB

ARC Wall Panels are an inexpensive way for end users to control Radius NX. ARCs are well suited for music source selection, volume control, paging control, room combining, and preset selection. Flexible and modular, they can be mixed and matched to provide basic control from multiple locations in any venue.

ARCs are programmed using Composer. Configuration and test take minutes, not days. ARC control parameters are stored in Radius NX hardware and can be easily recalled and modified should the need arise.

ARCs communicate over RS-485, a proven long-distance protocol. ARCs connect to Radius NX via CAT5/6. Multiple ARCs are daisy-chained using the dual RJ45 connectors on the back of each ARC.



ARC Wall Panels

