

# Eris™ Series E5 / E8

High-Definition Near Field Studio Monitors

Owner's Manual

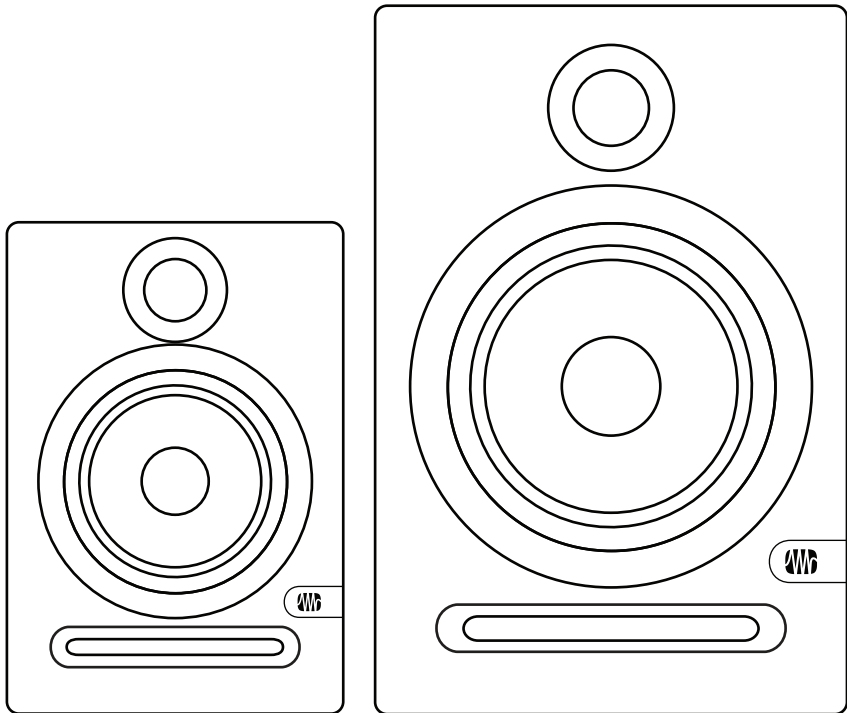



# Table of Contents

## **1 Overview — 1**

- 1.1 Introduction — 1
- 1.2 Summary of Eris E5/E8 Features — 2
- 1.3 What is in the box — 2

## **2 Hookup — 3**

- 2.1 Rear Panel Connections and Controls — 3
  - 2.1.1 Inputs — 3
  - 2.1.2 Power — 4
  - 2.1.3 Acoustic Tuning Controls — 4
- 2.2 Hookup Diagrams — 5
  - 2.2.1 Basic Setup — 5
  - 2.2.2 Advanced Setup with Speaker Switching — 6

## **3 Tutorials — 7**

- 3.1 Monitor Placement — 7
- 3.2 Input Gain Setting — 8
- 3.3 Equalizer Setting Suggestions — 8
- 3.4 Acoustic Space Setting Suggestions — 9

## **4 Resources — 10**

- 4.1 Technical Specifications — 10
- 4.2 Troubleshooting — 12
- 4.3 PreSonus Limited Warranty — 13



# 1 Overview

## 1.1 Introduction

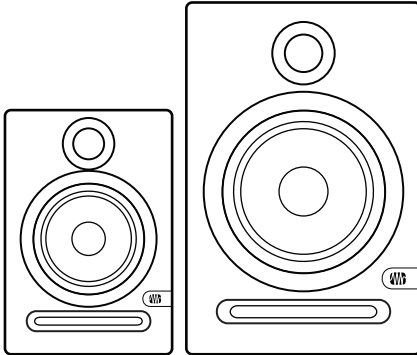

Thank you for purchasing the PreSonus Eris E5/E8 studio monitors. The E5 and E8 self-powered near-field monitors that offer excellent performance at a reasonable price for budget-conscious project studios, with features normally reserved for more expensive monitors.

We encourage you to contact us at 225-216-7887 (9 a.m. to 5 p.m. Central Time) with questions or comments regarding your PreSonus Eris E5/E8. PreSonus Audio Electronics is committed to constant product

improvement, and we value your suggestions highly. We believe the best way to achieve our goal of constant product improvement is by listening to the real experts: our valued customers. We appreciate the support you have shown us through the purchase of this product and are confident that you will enjoy your Eris E5/E8!

**ABOUT THIS MANUAL:** *We suggest that you use this manual to familiarize yourself with the features, applications, and correct connection procedures for your Eris E5/E8 before connecting it to the rest of your studio gear. This will help you avoid problems during installation and setup.*

*Throughout this manual you will find **Power User Tips** that can quickly make you an Eris expert. In addition to the Power User Tips, you will find several tutorials that cover monitor placement as well as setting the Input Level, EQ, and Acoustic Space controls.*

## 1.2 Summary of Eris E5/E8 Features

- 3 inputs: 2 balanced (XLR and ¼"TRS) and 1 unbalanced (RCA)
- Woven composite woofer and silk-dome tweeter
- Separate amplifiers that are optimized for the woofer and tweeter
- Front-firing acoustic port for superior bass frequency reproduction
- Input-level control with up to 35 dB of gain above unity
- High-frequency shelf EQ with  $\pm 6$  dB of boost/cut above 10 kHz
- Mid-frequency peak EQ with  $\pm 6$  dB of boost/cut centered at 1 kHz
- Low-frequency cutoff switch (flat, 80 Hz, 100 Hz) with -12 dB/octave slope
- Acoustic Space switch (0, -2 dB, -4 dB) to compensate for bass boost near a wall

## 1.3 What is in the box

In addition to this manual, your Eris E5/E8 package contains the following:

- (1) PreSonus Eris E5 **or** E8 powered studio monitor

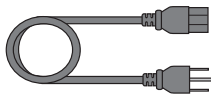
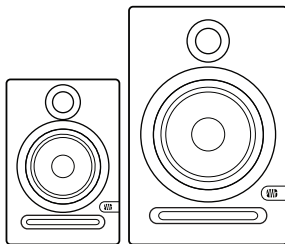

- (1) IEC power cable



- (4) Foam feet to be placed on the bottom of the speaker to improve isolation

## 2 Hookup

### 2.1 Rear Panel Connections and Controls

#### 2.1.1 Inputs

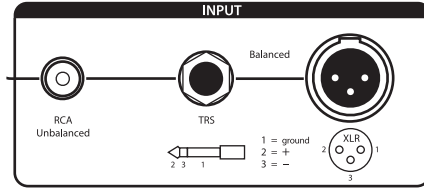

**Line-level Inputs.** The Eris E5/E8 provides a choice of three inputs: two balanced (XLR and 1/4" TRS) and one unbalanced (RCA). These inputs accept a line-level signal from your audio source and feed that signal to the monitor's built-in power amplifiers. These inputs are provided to allow for flexible connectivity and not for connecting multiple sources to your speakers simultaneously. **Please connect only one source to your Eris E5/E8.**

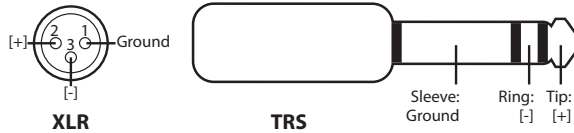

**Power User Tip:** If your audio source provides balanced XLR or 1/4" TRS (tip-ring-sleeve) outputs, use one of the corresponding balanced Eris inputs, since balanced cables are resistant to induced noise from radio-frequency or electromagnetic interference (RFI or EMI). If the audio source has unbalanced 1/4" TS (tip-sleeve) outputs, use a 1/4"-to-RCA adapter or adapter cable. Always use the shortest cable possible to minimize the risk of induced RFI or EMI noise.

**Input Gain:** Sets the level of the input signal before it is amplified.

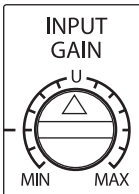

### 2.1.2 Power

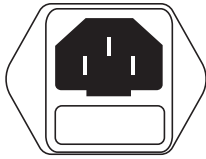

**IEC Power Connection:** Your Eris E5/E8 accepts a standard IEC power cord.

**Warning:** Do not remove the center grounding prong or use a ground-lift adapter, as this could result in electric shock.

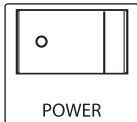

**Power Switch.** This is the On/Off switch. The power status is indicated by an LED on the front of the cabinet.



**AC Select Switch.** The input-power voltage is set at the factory to correspond with the country in which it was shipped. Use this switch only if you are using your Eris speakers in a country that uses a different standard voltage than is used in the country where you purchased your Eris E5 or E8.

### 2.1.3 Acoustic Tuning Controls

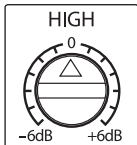

**High:** Boosts or cuts all frequencies above 10 kHz by  $\pm 6$  dB.

**Power User Tip:** The High control on the Eris E5/E8 is a high-shelf EQ and attenuates or boosts frequencies above 10 kHz. This EQ is much like the treble control on a car stereo: It raises or lowers the gain on all frequencies above the specified cutoff frequency. Shelving EQs can make big changes to the sound very quickly by adding or removing an entire range of frequencies.

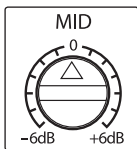

**Mid:** Boosts or cuts frequencies around 1 kHz by  $\pm 6$  dB.

The Mid control is a peak EQ that lets you boost or cut a specified frequency band (in this case, a band about two octaves wide, centered at 1 kHz). It's capable of more subtle changes.

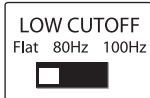

**Low Cutoff:** Rolls off the level of all frequencies below the specified frequency (80 or 100 Hz) at a slope of -12 dB/octave. Can be defeated by setting it to Flat, in which case, the monitor's natural rolloff takes over.

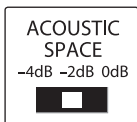

**Acoustic Space:** Cuts the level of all frequencies below 800 Hz by the specified amount (-2 or -4 dB) to compensate for the bass boost that occurs when the monitor is placed near a wall or corner. Can be defeated by setting it to 0 dB.



## 2.2 Hookup Diagrams

### 2.2.1 Basic Setup

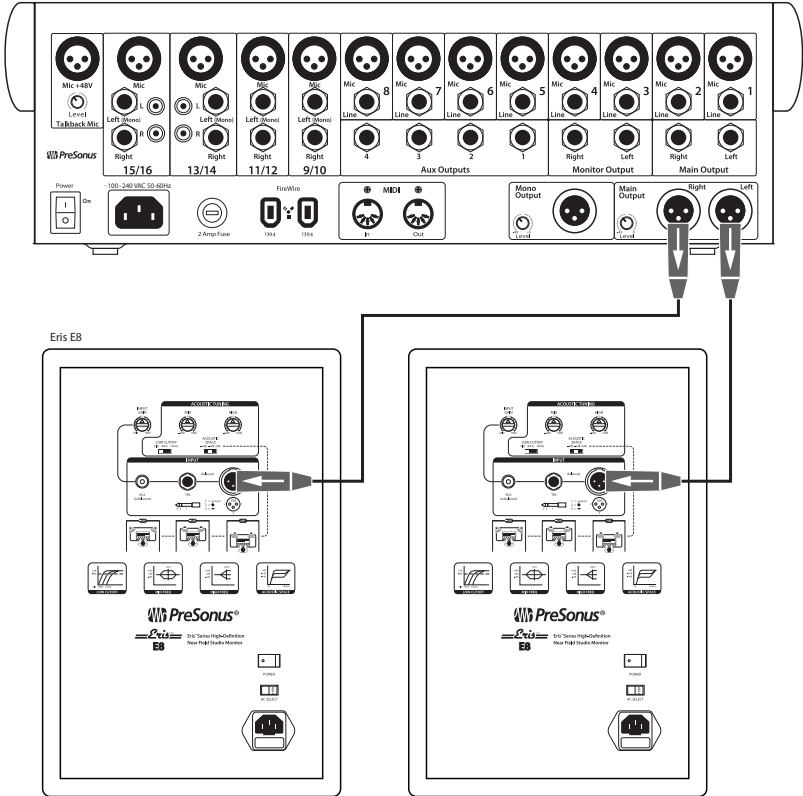

## 2.2.2 Advanced Setup with Speaker Switching

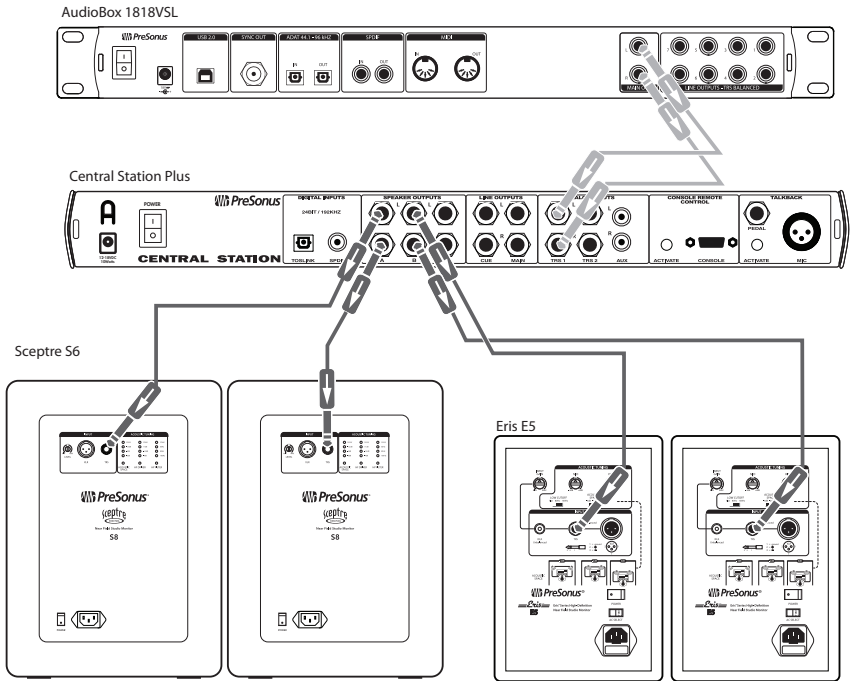

## 3 Tutorials

### 3.1 Monitor Placement

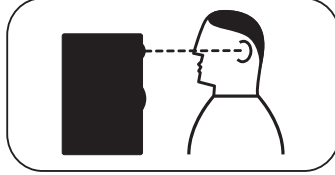

Ideally, near-field monitors should be placed so that the tweeters are at the same height as your ears when you are mixing.

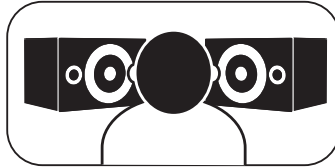

Eris speakers can be placed vertically or horizontally; when placed horizontally, they should form a mirror-image pair, with the tweeters on the outside.

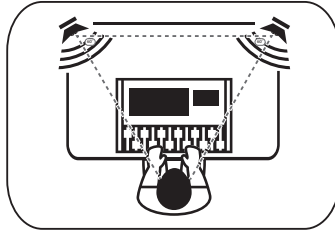

The speakers should be separated so that the tweeters form an equilateral triangle with your head. The monitors should be “toed in,” or angled, so that they are pointed at you, not pointed straight ahead.

## 3.2 Input Gain Setting

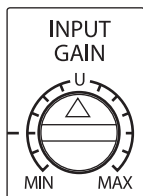

The best place to start is to set the Input Level control at its 12 o'clock position, which is labeled "U" for "unity gain." That means the level of the signal reaching the amplifier is the same as the level of the signal entering the monitor's input. This ensures a good, strong signal level without amplifying any extraneous noise. Make sure that the gain controls on your audio source have been optimized for maximum signal level and minimum noise. This process is called "gain staging," and you can learn about it from many online sources. You should always set the Input Gain on your Eris monitor so that all other level controls in the system needn't be turned way up or way down to achieve a comfortable listening volume.

If setting the input gain to Unity is unsatisfactory, you can try different settings, but remember that it's better to avoid settings above U if possible. If the volume is too loud at unity gain, feel free to turn the Input Gain control down a bit—but not so far that you have to crank your audio source's output level to its maximum setting. If you set it too low, you'll have to crank your audio source's output level way up, which will increase the audible noise from your source signal. If you set it too high, any noise in the signal will be amplified, which you don't want, either! Again, if you properly gain-stage your audio source, setting Input Gain to U or slightly lower should work fine.

Once the monitor's Input Gain control is set, leave it alone; don't use it as a system-volume control. Leave that job to your audio device's output-level control.

## 3.3 Equalizer Setting Suggestions

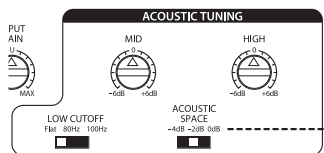

The Eris E5/E8 provides three EQ controls in its Acoustic Tuning section: High, Mid, and Low Cutoff. (There's also an Acoustic Space control, which is covered in the next section.) In general, setting the High control to 0 (no boost or cut) will produce the best results. However, if the sound is

generally too bright or shrill, try turning this control down below 0; if the sound is too dull and lifeless, try turning it up above 0. It's always better to cut than to boost and to use the smallest cut or boost needed to get the job done.

The Mid control is a mid-frequency peak filter that boosts or cuts frequencies centered on 1 kHz and extending about one octave above and below that frequency. Again, setting this control to 0 will generally produce the best results. If you want to emulate a car stereo, try turning it down below 0 to approximate the common "smiley face"

EQ curve. On the other hand, if you want to emulate a cheap portable radio, try turning it up above 0. Try not to boost much, since this can add noise to the signal.

The Low Cutoff control rolls off the low frequencies below the specified frequency (80 or 100 Hz). Engage this control if you are using a subwoofer in conjunction with the Eris E5/E8 monitors, and set it to the same frequency as the crossover to the subwoofer. If you're not using a subwoofer, set the control to Flat. If you want to emulate a cheap radio, engage this control at 80 or 100 Hz while boosting the Mid control.

**Power User Tip:** Do not use the EQ controls on your Eris monitor to correct problems in your mix. While this changes what you hear in the control room, it has no effect on your recorded audio.

### 3.4 Acoustic Space Setting Suggestions

When a monitor is placed close to a wall, or in a corner, the low frequencies tend to be emphasized more than if the monitor is far from any room boundary; this effect is called "boundary bass boost." It is most pronounced if the monitor is in a corner and less pronounced, but present, if the monitor is near one wall.

To compensate for this bass boost, the Eris E5/E8 provides an Acoustic Space switch that cuts all frequencies below 800 Hz by a fixed amount.

If the monitors are close to the corners of the room, start by setting the Acoustic Space switch to -4 dB, which provides the most bass attenuation.



If the monitors are close to the back wall, try setting the Acoustic Space switch to -2 dB for less attenuation.

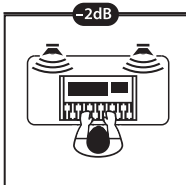

If the monitors are far from any wall, there will be no bass boost, so set the switch to 0 dB.

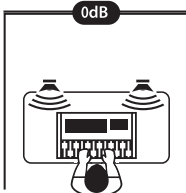

## 4 Resources

### 4.1 Technical Specifications

#### INPUTS (E5 and E8)

---

- 1- Balanced XLR
  - 1- Balanced ¼" TRS
  - 1- Unbalanced RCA
- 

#### PERFORMANCE

---

##### Frequency Response

E5	53 Hz – 22 kHz
E8	35 Hz – 22 kHz

---

##### Crossover Frequency

E5	3 kHz
E8	2.2 kHz

---

##### LF Amplifier Power

E5	45W
E8	75W

---

##### HF Amplifier Power

E5	35W
E8	65W

---

##### Peak SPL at 1M

E5	102 dB
E8	105 dB

---

##### LF Driver

E5	5.25" Woven composite
E8	8" Woven composite

---

##### HF Driver

E5	1" silk dome
E8	1.25" silk dome

---

##### Input Impedance

E5 and E8	10 kΩ
-----------	-------

---

## USER CONTROLS

---

### Volume Range

E5 and E8 A-type taper

---

### MF Control

E5 and E8 Variable (-6 to +6 dB)

---

### HF Control

E5 and E8 Variable (-6 to +6 dB)

---

### Low Cut

E5 and E8 Flat, 80 Hz, 100 Hz

---

### Acoustic Space

E5 and E8 Flat, -2 dB, -4 dB

---

## PROTECTION (E5 and E8)

---

RF interference

Output-current limiting

Over-temperature

Turn-on/off transient

Subsonic filter

External mains fuse

---

## POWER

---

E5 and E8 100-120V ~50/60 Hz or 220-240V ~50/60 Hz

---

## CABINET

---

E5 and E8 Vinyl-laminated MDF

---

## PHYSICAL

---

### (Width/Height/Depth)

E5 7" (178 mm) / 7.68" (195 mm) / 10.24" (260 mm)

E8 9.84" (250 mm) / 11.77" (299 mm) / 15.12" (384 mm)

---

### Weight

E5 10.2 lbs (4.63 kg)

E8 22.2 lbs (10.07 kg)

---

## 4.2 Troubleshooting

**No Power.** First ensure that your Eris E5/E8 is plugged in. If it's connected to a power conditioner, verify that the power conditioner is turned on and functioning.

If problem still exists, disconnect the power cable from your E5/E8 and check the fuse on the back panel of your E5/E8. The fuse housing is located directly beneath the IEC power cable connection. A blown fuse may look black on the inside or the wire inside might appear broken. A very black fuse is a sign that something may have shorted out. Try replacing the fuse with a new one. The E5 uses a T1L fuse. The Eris E8 uses a T2L fuse. If the fuse blows again, you will need to contact PreSonus for a repair.

**No audio.** If your Eris E5/E8 appears to power on but you hear no sound when playing audio from your audio source (the lights are on but nobody's home), first make sure that the cable connecting your audio source to the monitor is working correctly. Also, verify that the Input Gain control is set to provide enough amplitude for the signal.

**Hum.** Usually, hum is caused by a ground loop. Verify that all audio equipment is connected to the same power source. If you are not using a power conditioner, we highly recommend that you add one. Not only will this help to minimize hum, it will better protect your equipment from power surges, brownouts, etc.

Use balanced cables whenever possible. If your audio device does not offer a balanced output, you can connect it to a direct box, which will provide a ground-lift switch and a balanced output.

Finally, make sure that your audio cables are not run near power cables, and use cables that are the appropriate length for your application. Using cables that are too long not only increases the risk of noise, it increases the likelihood that the cables are coiled, which will essentially create an antenna that picks up all kinds of audio interference.



## 4.3 PreSonus Limited Warranty

PreSonus Audio Electronics, Inc., warrants this product to be free of defects in material and workmanship for a period of one year from the date of original retail purchase. This warranty is enforceable only by the original retail purchaser. To be protected by this warranty, the purchaser must complete and return the enclosed warranty card within 14 days of purchase. During the warranty period PreSonus shall, at its sole and absolute option, repair or replace, free of charge, any product that proves to be defective on inspection by PreSonus or its authorized service representative. If you are located in the USA and need warranty repair, please submit an online technical support request at <http://support.presonus.com> to receive a return-authorization number and shipping information. If you are located outside of the USA, please contact the PreSonus distributor for your region for warranty repairs. All inquiries must be accompanied by a description of the problem. All authorized returns must be sent to the PreSonus repair facility postage prepaid, insured, and properly packaged. PreSonus reserves the right to update any unit returned for repair. PreSonus reserves the right to change or improve the design of the product at any time without prior notice. This warranty does not cover claims for damage due to abuse, neglect, alteration, or attempted repair by unauthorized personnel and is limited to failures arising during normal use that are due to defects in material or workmanship in the product. Any implied warranties, including implied warranties of merchantability and fitness for a particular purpose, are limited in duration to the length of this limited warranty. Some states do not allow limitations on how long an implied warranty lasts, so the above limitation may not apply to you. In no event will PreSonus be liable for incidental, consequential, or other damages resulting from the breach of any express or implied warranty, including, among other things, damage to property, damage based on inconvenience or on loss of use of the product, and, to the extent permitted by law, damages for personal injury.

Some states do not allow the exclusion of limitation of incidental or consequential damages, so the above limitation or exclusion may not apply to you. This warranty gives you specific legal rights, and you may also have other rights, which vary from state to state. This warranty only applies to products sold and used in the United States of America. For warranty information in all other countries, please refer to your local distributor.

PreSonus Audio Electronics, Inc.  
7257 Florida Blvd.  
Baton Rouge, LA 70806 USA  
1-225-216-7887  
[www.presonus.com](http://www.presonus.com)

## Added bonus: PreSonus' previously Top Secret recipe for... **Rice Dressing**

### **Ingredients:**

- 1lb ground beef
- 1 lb chopped chicken liver
- 1 onion (diced)
- 2 green peppers (diced)
- 4-6 celery stalks (diced)
- 2 garlic cloves (minced)
- ¼ C. chopped fresh parsley
- 3 C. chicken stock
- 6 C. cooked rice
- 1 Tbs. oil
- Salt and pepper to taste
- Cayenne pepper to taste

### **Cooking Instructions:**

1. In a large pot, heat oil on medium high and add meat, salt, and pepper to taste. Stir until meat begins to brown.
2. Lower heat and add all vegetables. Cook until onions are transparent and celery is very tender. Add stock as necessary to prevent burning.
3. Stir in cooked rice. Add remaining stock and simmer on low until ready to serve.

