



Installation and Operation Manual

# Blackmagic Converters

June 2018

English, 日本語, Français, Deutsch, Español, 中文,  
한국어, Русский, Italiano, Português and Türkçe.

# Languages

To go directly to your preferred language, simply click on the hyperlinks listed in the contents below.

<a href="#">English</a>	3
<a href="#">日本語</a>	92
<a href="#">Français</a>	182
<a href="#">Deutsch</a>	272
<a href="#">Español</a>	362
<a href="#">中文</a>	452
<a href="#">한국어</a>	542
<a href="#">Русский</a>	632
<a href="#">Italiano</a>	722
<a href="#">Português</a>	812
<a href="#">Türkçe</a>	902



## Welcome

Thank you for purchasing Blackmagic Converters for your production needs.

Blackmagic Mini Converters, Mini Converter Heavy Duty, Battery Converters and Micro Converters give you a solution for virtually any conversion you could need. Mini Converters convert analog to digital, digital to analog, SDI to audio, audio to SDI, up, down and cross conversion, SDI distribution, and can even provide a sync generator for locking all your video equipment to the same reference signal. Mini Converter Heavy Duty gives you the same conversions in a super tough design that's perfect for use on location and Battery Converters let you work on location with or without external power. Blackmagic Micro Converters are even smaller, designed for popular conversions such as SDI to HDMI and HDMI to SDI so you can plug any HDMI output into SDI video recorders and switchers, or plug SDI video equipment into HDMI monitors.

This instruction manual contains all the information you need to start using your Blackmagic Converters.

Please check the support page on our web site at [www.blackmagicdesign.com](http://www.blackmagicdesign.com) for the latest version of this manual and for updates if your Blackmagic Converter has internal software. Keeping your internal software up to date will always ensure you get all the latest features. When downloading software, please register with your information so we can keep you updated when new software is released. We are constantly working on new features and improvements, so we would love to hear from you!

A handwritten signature in black ink that reads "Grant Petty". The signature is written in a cursive, flowing style.

**Grant Petty**

CEO Blackmagic Design

# Contents

## Blackmagic Converters

<b>Getting Started</b>	5	Mini Converter HDMI to SDI 4K	34
Plugging in Power	5	Mini Converter HDMI to SDI 6G	37
Plugging in Video	6	Mini Converter SDI to Analog	40
Plugging in Audio	7	Mini Converter SDI to Analog 4K	45
<b>Installing Administration Software</b>	8	Mini Converter Analog to SDI	49
Installing Blackmagic Converters Setup	8	Mini Converter SDI to Audio	53
Updating the Internal Software	9	Mini Converter SDI to Audio 4K	56
Updating Mini Converter SDI Distribution 4K	10	Mini Converter Audio to SDI	59
<b>Changing Settings</b>	11	Mini Converter Audio to SDI 4K	63
Changing Settings using Switches	11	Mini Converter Optical Fiber	67
Changing Settings using Blackmagic Converters Setup	12	Mini Converter Optical Fiber 4K	68
About Tab	13	Mini Converter Optical Fiber 12G	69
<b>Blackmagic Converter Models</b>	13	Mini Converter Quad SDI to HDMI 4K	70
<b>Teranex Mini Converters</b>	13	Mini Converter SDI Distribution	71
<b>Blackmagic Micro Converters</b>	14	Mini Converter SDI Distribution 4K	72
Micro Converter SDI to HDMI	14	Mini Converter SDI Multiplex 4K	73
Micro Converter HDMI to SDI	15	Mini Converter Sync Generator	76
Micro Converter BiDirectional SDI/HDMI	17	Mini Converter UpDownCross	79
<b>Blackmagic Mini Converters</b>	19	Mini Converter UpDownCross HD	83
Mini Converter SDI to HDMI	19	Converter Setup Utility	86
Mini Converter SDI to HDMI 4K	22	<b>Blackmagic Battery Converters</b>	87
Mini Converter SDI to HDMI 6G	26	Battery Converter SDI to HDMI	87
Mini Converter HDMI to SDI	31	Battery Converter HDMI to SDI	88
		<b>Help</b>	90
		<b>Warranty</b>	91

# Getting Started

Getting started with your Blackmagic Converter is as simple as plugging in power, plugging your source video into your converter's video input, and plugging the video output into your destination equipment.

## Plugging in Power

Plug in the included 12 volt power supply using the socket adapter for your country. If your converter has a built in cable tie point, you can easily secure the power connection to your converter.

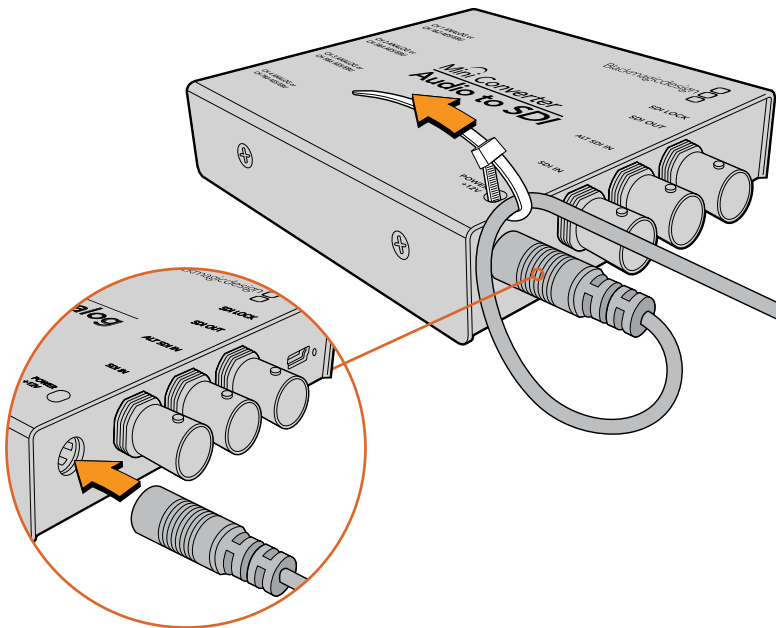

Locking the power cable to the converter's cable tie point prevents accidental disconnection.

### Micro Converter

Blackmagic Micro Converter is powered using the micro USB connector. This gives you a convenient and flexible power solution. For example you can easily connect power using the battery charger for some modern cell phones, or even power your converter via the USB port of your laptop computer. Any device capable of providing 5V via a standard USB to Micro USB cable can power your Blackmagic Micro Converter.

### Battery Converters

Blackmagic Battery Converters have a switch labeled 'On Batt Off' that is used to switch between mains power and battery power. When set to 'On', the Battery Converter will keep working even if external power is lost. When set to 'Off', only external power is used to ensure built in battery power is saved. The LED near the switch indicates the battery charge level by a continuous illumination for 100 percent charge, three flashes for 50 to 90 percent charge, two flashes for 10 to 50 percent charge and a single flash if less than 10 percent charge is remaining.

## Plugging in Video

To connect your video inputs and outputs, simply plug your source video into your converter's video input and plug the video output into your destination equipment.

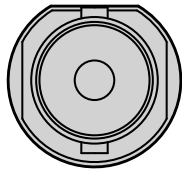

BNC

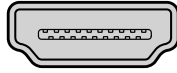

HDMI

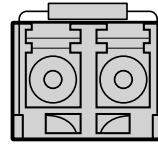

Optical Fiber

Depending on your Blackmagic Converter model, the video connectors may be BNC, HDMI, or optical fiber LC.

### Optical Fiber Connectors

Some Blackmagic Converter models include an SFP socket to accept a compatible SFP optical fiber module that supports up to 3G, 6G or 12G-SDI video. The module is an optical transmitter and receiver with sockets for optical fiber cables.

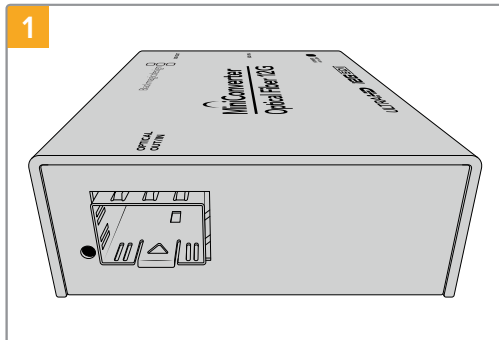

Examine the Optical Out/In socket to make sure it is free of dust.

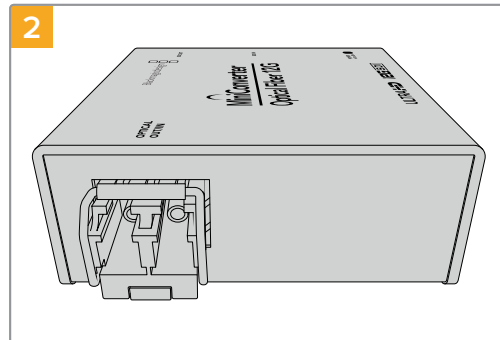

Remove the protective cover from the SFP optical fiber module, and insert it in the SFP socket. A locking pin clicks into position to secure the module in the socket.

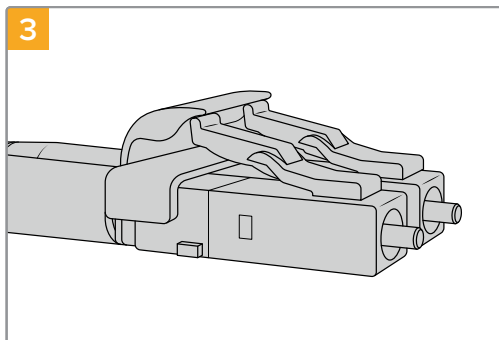

The optical fiber cables have latching tabs on top to make sure they don't fall out.

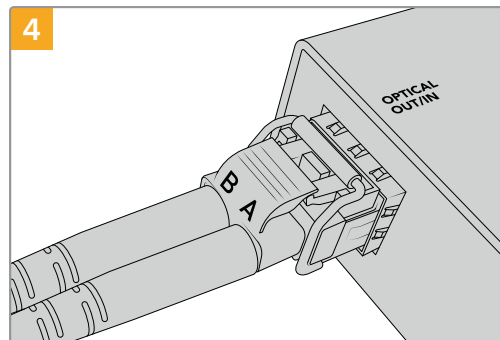

Plug in the optical fiber cables. Confirm the Out and In plugs are in the correct sockets, and that the locking tabs on the plugs hold the lever of the SFP optical fiber module upright.

### Fail Safe Alternate SDI inputs

Some Blackmagic Converter models include alternative SDI inputs for redundancy. These inputs are labeled 'Alt SDI In' and will immediately take over should the primary SDI input signal fail. In this rare scenario, the SDI LOCK LED will flash, indicating that the converter has switched to the ALT SDI input.

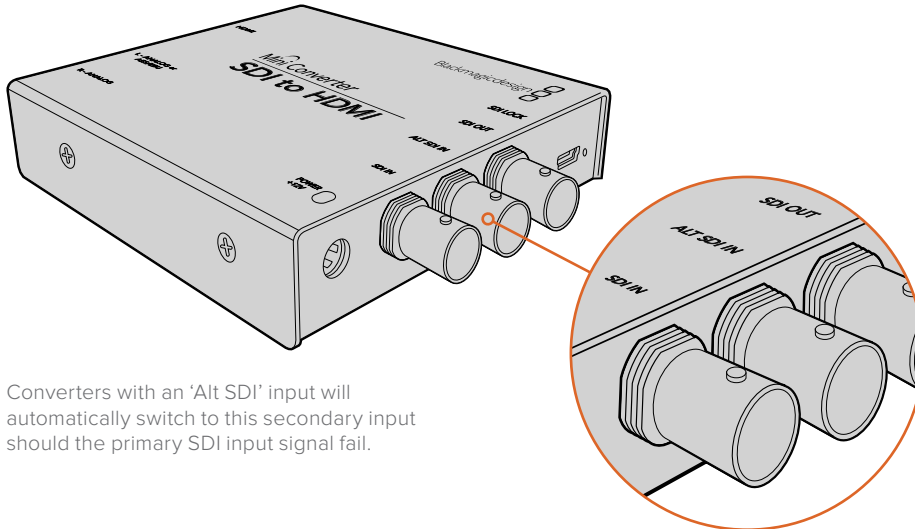

Converters with an 'Alt SDI' input will automatically switch to this secondary input should the primary SDI input signal fail.

## Plugging in Audio

### Jack Audio Connectors

Some Blackmagic Converters have built in 1/4" jacks, so you can easily plug in balanced external analog or digital AES/EBU audio. The 1/4" jacks are balanced TRS connectors. TRS stands for Tip, Ring, Sleeve which refers to the three contacts of the jack connector.

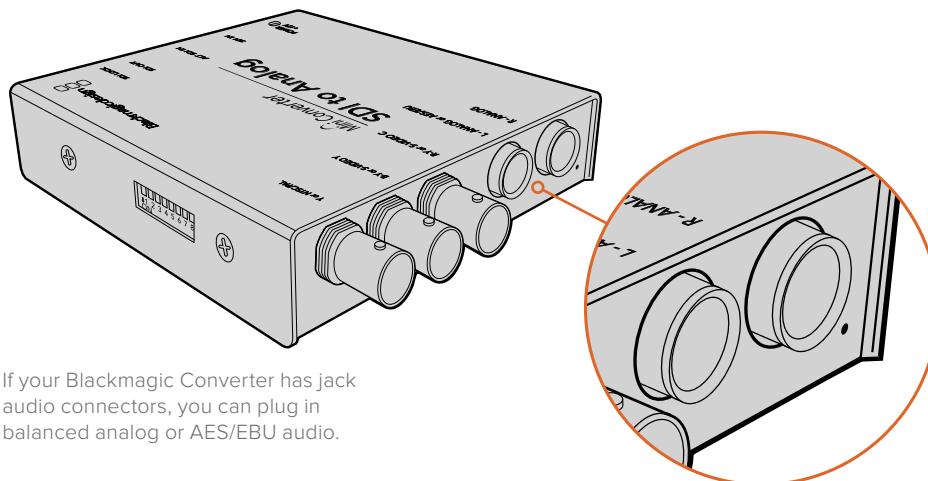

If your Blackmagic Converter has jack audio connectors, you can plug in balanced analog or AES/EBU audio.

Below is an illustration showing the wiring pins inside the male 1/4" jack connector if you want to make your own audio cables.

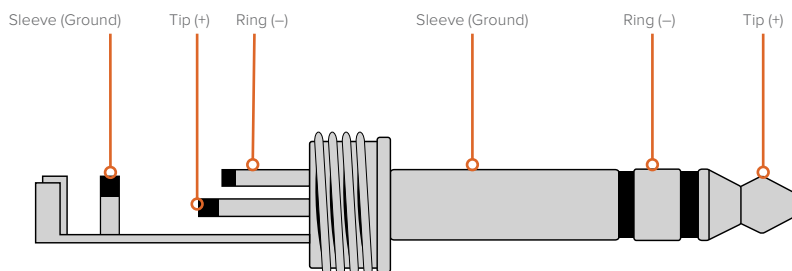

The audio jack illustration on the previous page shows the jack connector's positive, negative and ground wiring pins. If you need to reverse the polarity of your analog audio cable to suit your audio equipment, you can simply swap the positive and negative wiring on the tip and ring pins.

**NOTE** If you are connecting stereo analog audio, it's worth mentioning that if you reverse the polarity for one channel jack connector, make sure you do the same for the second or your stereo analog audio will be out of phase.

## Installing Administration Software

### Installing Blackmagic Converters Setup

Blackmagic Converters Setup is used to change settings on your converter and to update your converter's internal software. The settings available will depend on the converter you are using. However, some Blackmagic Converters don't require any adjustable settings and don't have internal software, therefore these particular converters will not have a USB connector. If your converter is one of these, you can go straight to your converter model in this manual to learn more about it.

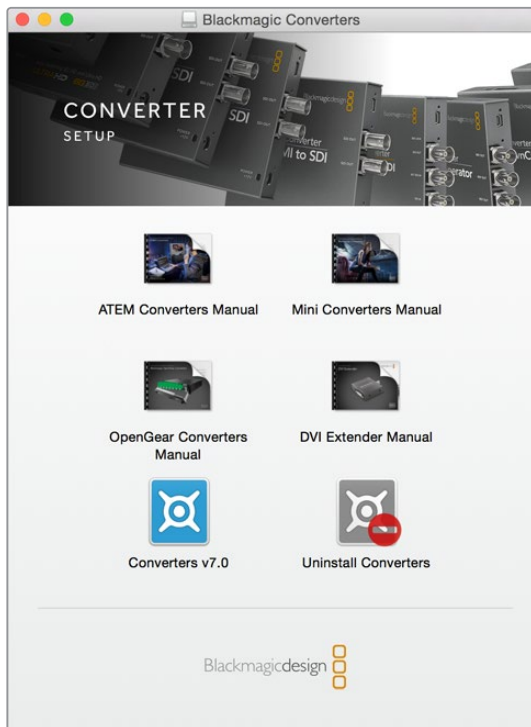

Blackmagic Converters Setup can be installed on Mac OS X and Windows computers.



### Installation on Mac OS X

- 1 Download the Blackmagic Converters Setup software from [www.blackmagicdesign.com](http://www.blackmagicdesign.com)
- 2 Unzip the downloaded file and open the resulting disk image to reveal its contents.
- 3 Double click the installer and follow the prompts to complete the installation.
- 4 When the installation has finished, click 'close'. Blackmagic Converters Setup is now installed.

### Installation on Windows

- 1 Download Blackmagic Converters Setup from [www.blackmagicdesign.com](http://www.blackmagicdesign.com)
- 2 Unzip the downloaded file. You should see a Blackmagic Converters Setup folder containing this PDF manual and the Blackmagic Converters Setup installer.
- 3 Double click the installer and follow the prompts to complete the installation.
- 4 Click 'finish' to complete the installation.

Blackmagic Converters Setup is now ready to use.

## Updating the Internal Software

If your Blackmagic Converter has a USB connector, then you may have additional settings you can change, plus you can update your converter with the latest internal software. The latest software can be downloaded from the Blackmagic Design support center at [www.blackmagicdesign.com/support](http://www.blackmagicdesign.com/support).

When updating Blackmagic Micro Converters, power is already supplied via the USB port, so you don't have to worry about connecting power.

On Blackmagic Mini Converters, Battery Converters and Mini Converters Heavy Duty, you'll need to ensure your converter is powered before connecting to your computer via USB.

- 1 Power your converter.
- 2 Attach a USB cable from the computer to the converter and launch the Blackmagic Converter Setup.

Your Blackmagic Converter will be displayed on the setup utility's home page. If you have more than one converter connected via USB, click on the arrow icons on the left or right side of the home page to select your desired converter.

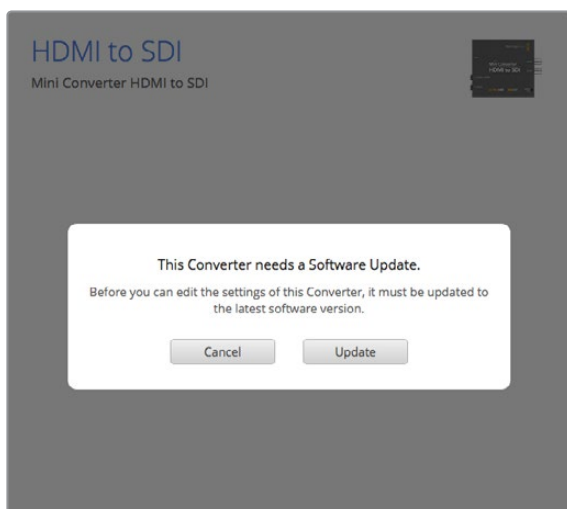

If Blackmagic Converters Setup detects an earlier version of your converter's internal software, it will prompt you to update.

If no converter is connected, the home page will display “no converters found”. If you have a converter connected to your computer via USB, but you don’t have power plugged in, the home page may display ‘no power connected’. Simply plug power into your converter to access the settings.

If Blackmagic Converters Setup contains newer internal software than that currently installed in your Blackmagic Converter, it will prompt you to update. Simply follow the on screen instructions to complete the update.

## Updating Mini Converter SDI Distribution 4K

Blackmagic Mini Converter SDI Distribution 4K has an internal USB connector. This mini converter has no user adjustable settings, so you will never need to connect setup software. Very occasionally, though, internal software updates will be released to improve compatibility with some devices. For example, Blackmagic Converters Software version 7.0.9 improves this mini converter’s compatibility with level A 3G SDI signals.

If a particular update applies to the equipment you are using with Mini Converter SDI Distribution 4K, follow these steps to access your mini converter’s USB connector:

**NOTE** Make sure you disconnect power before accessing your Mini Converter SDI Distribution 4K. We recommend this job is undertaken by a qualified engineer using an anti static strap.

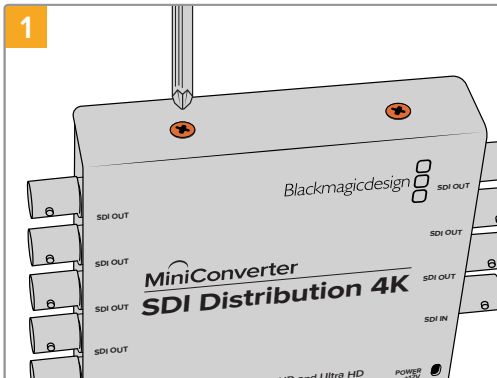

Using a philips head screwdriver, remove the four (M3) screws on the sides of Mini Converter SDI Distribution 4K.

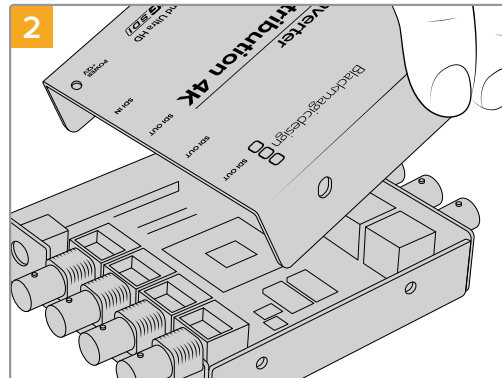

Slide off the external cover.

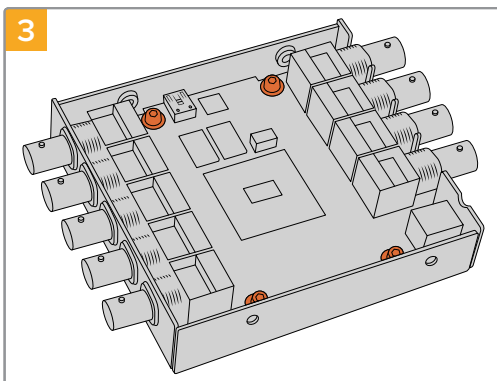

Using a T10 torx screwdriver, remove the four screws connecting the circuit board to Mini Converter SDI Distribution 4K’s frame.

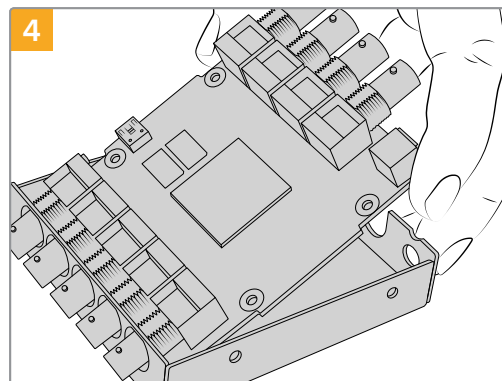

Gently pull the circuit board from the frame to access the USB connector.

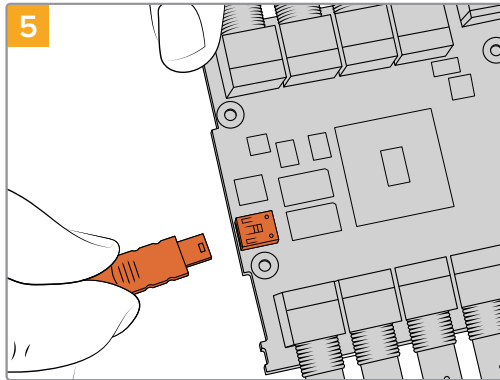

Plug in your Mini Converter SDI Distribution 4K's power supply and connect it to a computer using a USB cable. Update the internal software as you would any other mini converter.

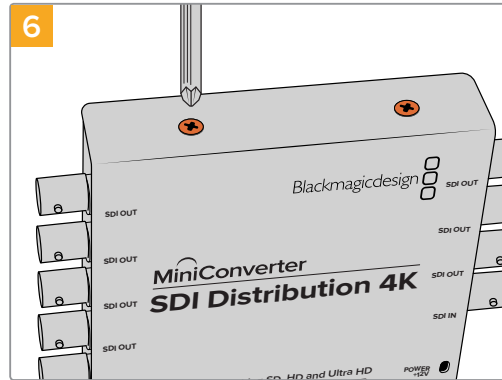

Repeat steps 1 - 4 in reverse to reassemble Mini Converter SDI Distribution 4K.

**NOTE** When handling your Mini Converter SDI Distribution 4K's circuit board, be careful to always hold it by the edges to prevent accidentally short circuiting internal components.

## Changing Settings

If your Blackmagic Converter has adjustable settings, there are two ways you can change them. You can use the built in switches on the side of your converter, or you can change settings using the Blackmagic Converters Setup utility software. The utility is also used to change any settings that can't be set using the switches, for example analog video and audio levels.

### Changing Settings using Switches

Many Blackmagic Converter models have built in switches.

To change a switch setting simply push the switch up or down using the tip of a pen. This turns the switches on or off. With 8 switches, this gives you many combinations so you can choose exactly the conversion settings you want.

You'll find a switch settings diagram printed on the base of your converter. Ensure your switch settings correspond to the legend by observing the switch numbers from 1 to 8, left to right.

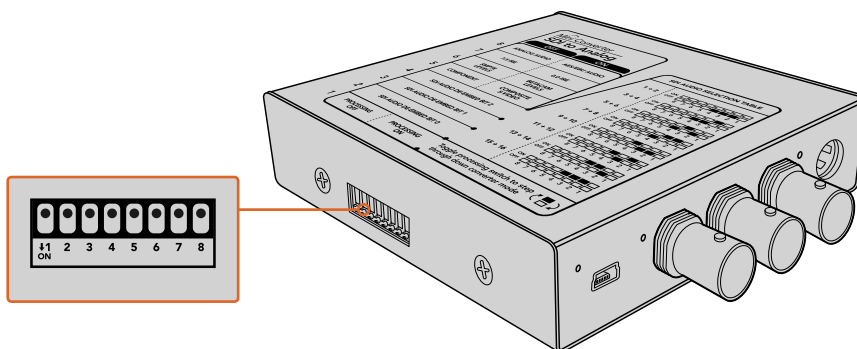

Change settings by adjusting the switches with a pen.

For a full description of the switches and their settings, refer to your converter model in this manual. Even though switch settings are printed on the base of your converter, new features in later updates can add new settings so it's worth checking the latest version of this manual for the most up to date information. You can download the latest version from the Blackmagic Design support center at [www.blackmagicdesign.com/support](http://www.blackmagicdesign.com/support).

## Changing Settings using Blackmagic Converters Setup

Once Blackmagic Converters Setup is installed on your computer, connect the setup utility to your Blackmagic Converter via USB.

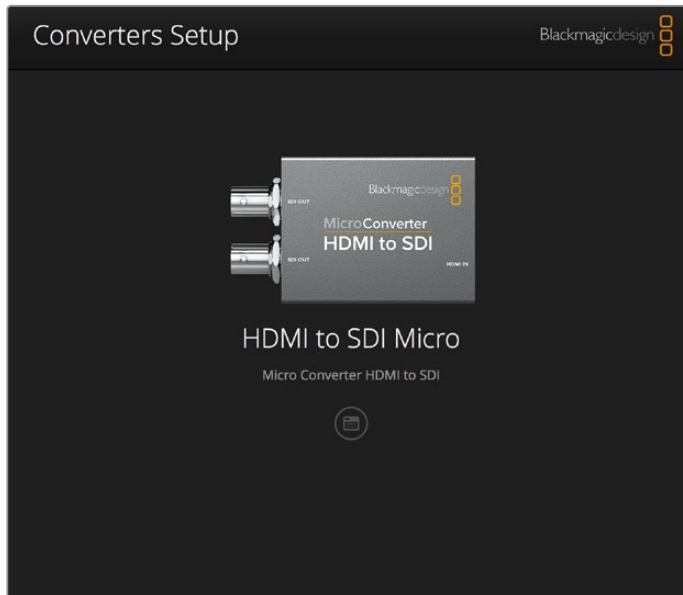

The Blackmagic Converters setup utility lets you update your converter's internal software and adjust settings using a Mac OS X or Windows computer.

The first thing you'll see when launching the software is the 'home' page. If you have more than one converter connected to your computer, select your desired converter by clicking the arrows on the left and right side of the Blackmagic Converters Setup home page.

To change settings, click on the 'settings' icon below the image of your Blackmagic Converter. Adjustments will be immediately saved to your converter. This means if power is lost, your settings will be reestablished as soon as power is restored.

Even though most settings are configured using the built in switches, some settings can only be set using the setup software, for example adjusting analog video or audio levels.

**TIP** Teranex Mini Converters are 12G-SDI converters that support even more video formats including up to 4K DCI 60p. If you are looking for information on how to use a Teranex Mini Converter, including how to change settings using the Blackmagic Teranex Setup utility, refer to the Teranex Mini Converters manual. You can download the most up to date manual from the Blackmagic Design support center at [www.blackmagicdesign.com/support](http://www.blackmagicdesign.com/support)

## About Tab

The 'about' tab in Blackmagic Converters Setup is common across all converter models. You can use the settings in this tab to name your Blackmagic Converter. Simply click in the 'name' text box and type your desired converter name. Click 'save' to confirm the change.



The 'about' tab in Blackmagic Converters Setup is used to name your Blackmagic Converter. You can also check the version of the setup software.

The 'Software Information' menu in the 'about' tab identifies which software version your Blackmagic Converter is running. If your converter's internal software is older than the current version that comes with Blackmagic Converters Setup, an update button will be present here that allows you to bring your converter's software up to date.

## Blackmagic Converter Models

Blackmagic Converters provide conversion solutions for all types of conditions. For example, Mini Converters are tough and lightweight so you can mount them on video equipment or video trays, Battery Converters are super strong with a built in rechargeable battery so are portable and self powered and Blackmagic Micro Converters are tiny SDI to HDMI and HDMI to SDI converters that can be powered via USB so are perfect for attaching to monitors and laptop computers.

The following pages contain information about your Blackmagic Converter, plus switch settings and setup software settings.

## Teranex Mini Converters

Blackmagic Teranex Mini Converters are 12G-SDI converters that support video formats up to 4K DCI 60p. These converters can be controlled using an optional Teranex Mini Smart Panel with built in LCD, buttons and a rotary knob, and can be powered via Ethernet. If you are looking for information about these converters, including controlling them via the Blackmagic Teranex Setup utility, refer to the Teranex Mini Converters manual which you can download from the Blackmagic Design support center at [www.blackmagicdesign.com/support](http://www.blackmagicdesign.com/support)

# Blackmagic Micro Converters

## Micro Converter SDI to HDMI

With Micro Converter SDI to HDMI you can connect a huge range of HDMI displays and video projectors to SDI based equipment. Your Micro Converter SDI to HDMI automatically detects between SD/HD/3G-SDI and converts to HDMI with embedded audio. This tiny broadcast quality converter is protected by a strong aluminum chassis and powers over USB, meaning you can power your Blackmagic Micro Converter via your laptop or television's USB connector using a common micro USB cable. Micro USB cables are used to connect some cell phones to chargers and laptops, so if you have one of these, you can use the same cable. If the USB connector on your cable is a different type, the correct cable can be purchased from most electronic equipment stores.

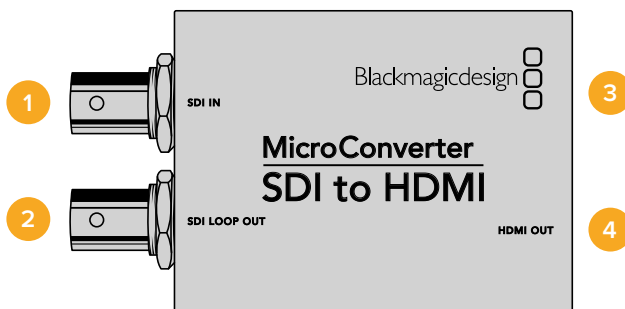

## Connectors

- 1 SDI In**  
Primary SDI input BNC connector.
- 2 SDI Loop**  
Loop through output of your SDI input BNC connector.
- 3 Micro USB / Power**  
Provides power from the included adapter or any device capable of providing 5V via a standard USB to Micro USB cable, such as a laptop or television. Also connects to Blackmagic Converters Setup software via your Mac OS X or Windows Computer.
- 4 HDMI Out**  
HDMI type A video output.

## Blackmagic Converters Setup Settings

The Blackmagic Converters Setup utility can be used to change settings and update your Micro Converter's software. You can access these settings by moving between the 'video' and 'about' tabs.

The 'about' tab is detailed in the 'changing settings' section in this manual.

The 'video' tab for Micro Converter SDI to HDMI contains the following settings.



The 'clip video output to legal levels' setting is checked by default. This setting ensures your HDMI output is a true representation of the SDI input.

### Processing menu

The 'clip video output to legal levels' checkbox controls clipping of your SDI input to ensure that it stays within HDMI legal levels and should be kept on by default.

### Micro Converter SDI to HDMI Block Diagram

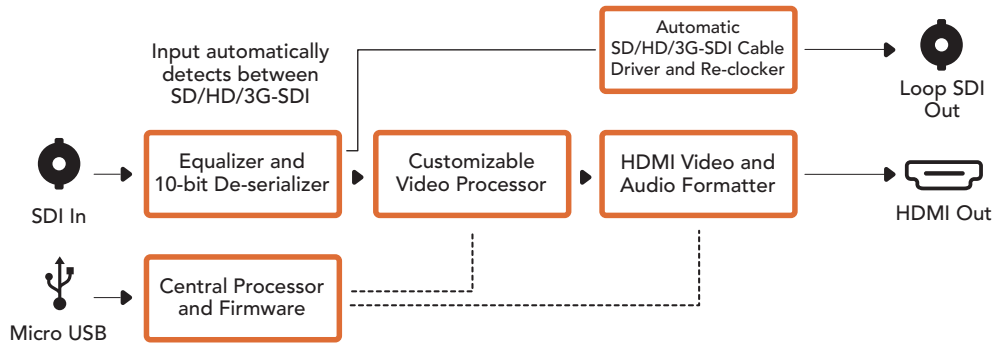

### Micro Converter HDMI to SDI

You can use Micro Converter HDMI to SDI to convert HDMI outputs from devices such as HDV cameras and game consoles to SDI. This means you can send video signals from HDMI over SDI using the longest SDI cables. You can even add SDI outputs to computers with HDMI compatibility. This tiny broadcast quality converter is protected by a strong aluminum chassis and powers over USB, meaning you can power your Blackmagic Micro Converter via your laptop or television's USB connector using a common micro USB cable. Micro USB cables are used to connect some cell phones to chargers and laptops, so if you have one of these, you can use the same cable. If the USB connector on your cable is a different type, the correct cable can be purchased from most electronic equipment stores.

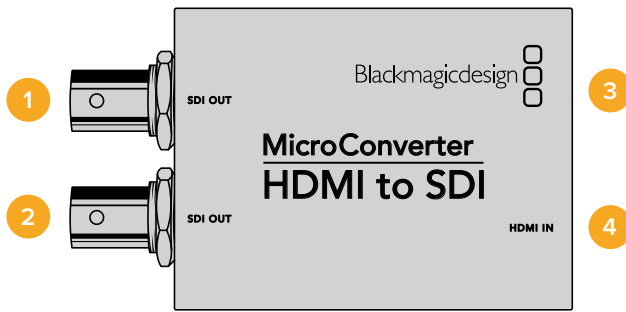

## Connectors

- 1 **SDI OUT**  
SDI video output BNC connector.
- 2 **SDI OUT**  
Second SDI output.
- 3 **Micro USB / Power**  
Provides power from the included adapter or any device capable of providing 5V via a standard USB to Micro USB cable, such as a laptop or television. Also connects to Blackmagic Converters Setup software via your Mac OS X or Windows Computer to update the Micro Converter's internal software.
- 4 **HDMI In**  
HDMI type A video input.

## Blackmagic Converters Setup Settings

The Blackmagic Converters Setup utility can be used to change settings and update your Micro Converter's software. You can access these settings by moving between the 'video,' and 'about' tabs.

The 'about' tab is detailed in the 'changing settings' section in this manual.

The 'video' tab for Micro Converter HDMI to SDI contains the following settings.

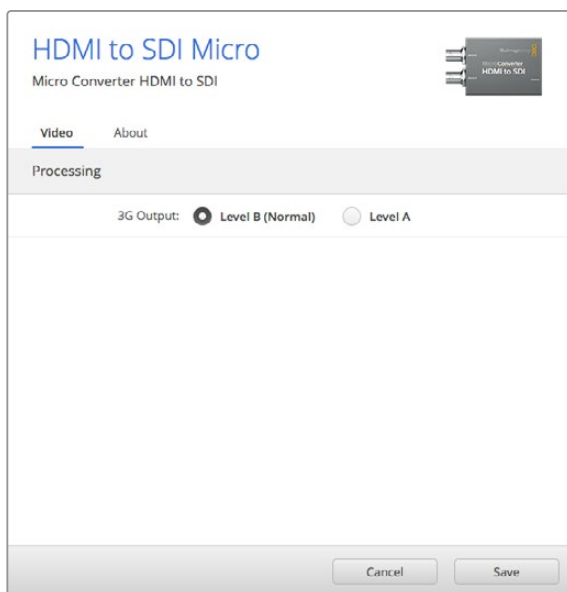

Use the 'video' tab in Blackmagic Converters Setup to toggle SDI levels.



## Processing menu

The '3G Output' menu lets you select between Level A or Level B 3G-SDI. This setting lets you change the 3G-SDI output standard to maintain compatibility with equipment that can only receive level A or level B 3G-SDI video. Level B is the default setting.

## Micro Converter HDMI to SDI Block Diagram

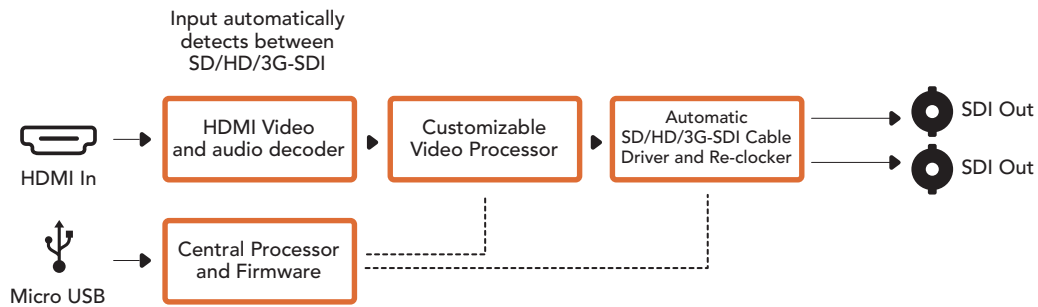

## Micro Converter BiDirectional SDI/HDMI

Micro Converter BiDirectional SDI/HDMI converts SD and HD video from HDMI to SDI, and SDI to HDMI with embedded audio simultaneously. For example, you can convert the HDMI output from an HDV camera to SDI for longer cable lengths, while also converting an SDI return feed to HDMI so you can connect to an HDMI TV.

If you have only one input connected, the SDI and HDMI outputs both become loop outputs so you can feed the input signal to other HDMI and SDI equipment.

Your Micro Converter BiDirectional SDI/HDMI automatically detects SD/HD/3G-SDI input format and sets the output format to match.

This tiny broadcast quality converter is protected by a strong aluminum chassis. It is powered over USB, meaning you can power your Blackmagic Micro Converter BiDirectional SDI/HDMI from your laptop or television's USB connector using a common micro USB cable. Micro USB cables are used to connect some cell phones to chargers and laptops, so if you have one of these, you can use the same cable. If the USB connector on your cable is a different type, the correct cable can be purchased from most electronic equipment stores.

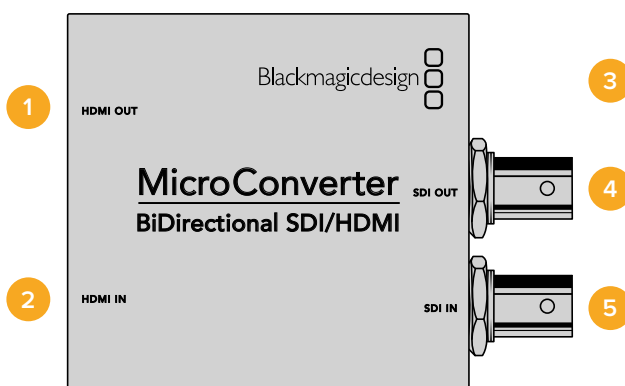

## Connectors

- 1 HDMI Out**  
HDMI type A video output.
- 2 HDMI In**  
HDMI type A video input.
- 3 Micro USB / Power**  
Provides 5V power from any device capable of providing 5V via a standard USB to Micro USB cable, such as a laptop or television. Also connects to Blackmagic Converters Setup software via your Mac OS X or Windows Computer.
- 4 SDI Out**  
SDI video output BNC connector.
- 5 SDI In**  
SDI video input BNC connector.

## Blackmagic Converters Setup Settings

The Blackmagic Converters Setup utility can be used to change settings and update your Micro Converter's software. You can access these settings by moving between the 'video,' and 'about' tabs.

The 'About' tab is described in the 'Changing Settings' section in this manual.

The 'Video' tab for Micro Converter BiDirectional SDI/HDMI contains the following settings.

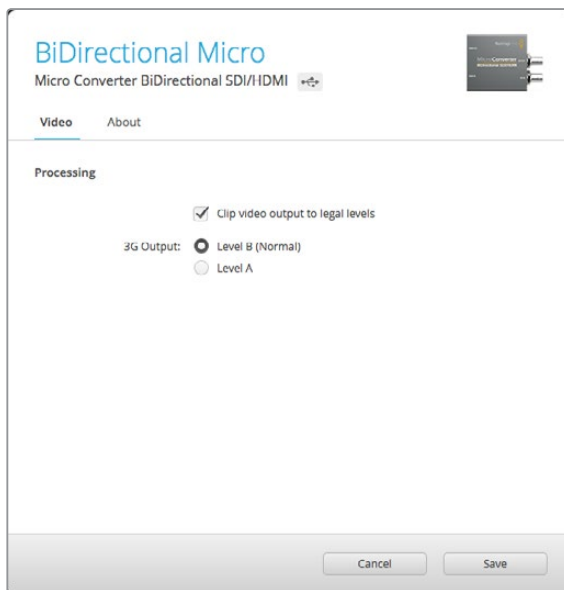

The 'Clip video output to legal levels' setting is checked by default. This setting makes sure your HDMI output is a true representation of the SDI input.

### Processing menu

The 'Clip video output to legal levels' checkbox controls clipping of your SDI input to ensure that it stays within HDMI legal levels and should be kept on by default.

The '3G Output' setting lets you select between Level A or Level B 3G-SDI. This changes the 3G-SDI output standard to maintain compatibility with equipment that can receive only Level A or level B 3G-SDI video. The default setting is Level B.

## Micro Converter BiDirectional SDI/HDMI Block Diagram

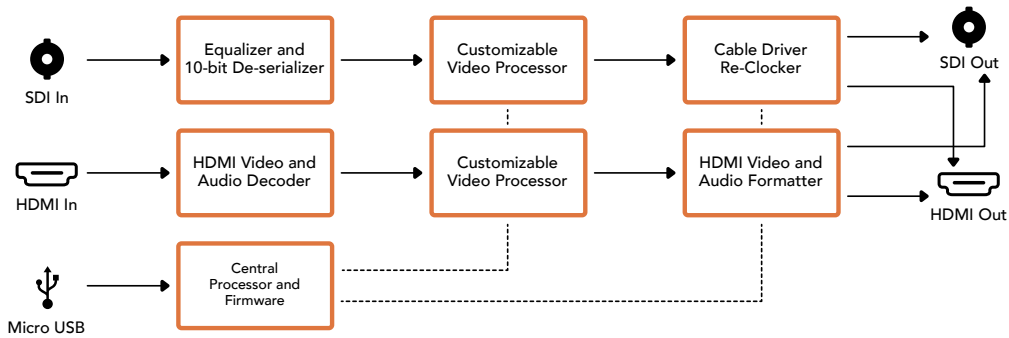

# Blackmagic Mini Converters

## Mini Converter SDI to HDMI

Mini Converter SDI to HDMI can connect a huge range of HDMI displays and video projectors to SDI based equipment. Your Mini Converter SDI to HDMI automatically detects between SD/HD/3G-SDI and converts to HDMI with embedded audio, plus balanced AES/EBU or analog audio out.

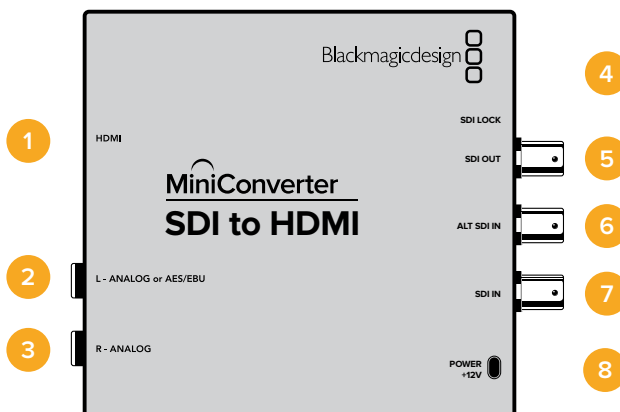

## Connectors

- 1 HDMI**  
HDMI type A video output.
- 2 L - ANALOG or AES/EBU**  
Balanced left channel analog audio, or AES/EBU digital audio output on a 1/4" jack connector.
- 3 R - ANALOG**  
Balanced right channel analog audio output 1/4" jack connector.
- 4 MINI-B USB PORT**  
Connects to the Converters Setup software via your Mac OS X or Windows computer. The Mini Converter's internal software is also updated using the USB port.
- 5 SDI OUT**  
SDI video output on a BNC connector.

- 6 ALT SDI IN**  
Redundant SDI input is provided as an optional back up.
- 7 SDI IN**  
Primary SDI input.
- 8 POWER +12V**  
12 volt power supply input.

## Switches

### Switch 8 - Analog Audio, AES/EBU Audio

Set switch 8 to OFF to select balanced analog audio, or to ON for digital AES/EBU audio output.

### Switch 4 - SDI Audio De-Embed Bit 2

Switches 4, 3 and 2 are grouped together to provide 8 ON/OFF combinations. Having eight different combinations allows eight independent pairs of audio channels to be de-embedded from your SDI input and output to HDMI, analog or AES/EBU audio.

### Switch 3 - SDI Audio De-Embed Bit 1

See switch 4 description.

### Switch 2 - SDI Audio De-Embed Bit 0

See switch 4 description.

### Switch 1 - Processing Off - Processing On

This switch is not used.

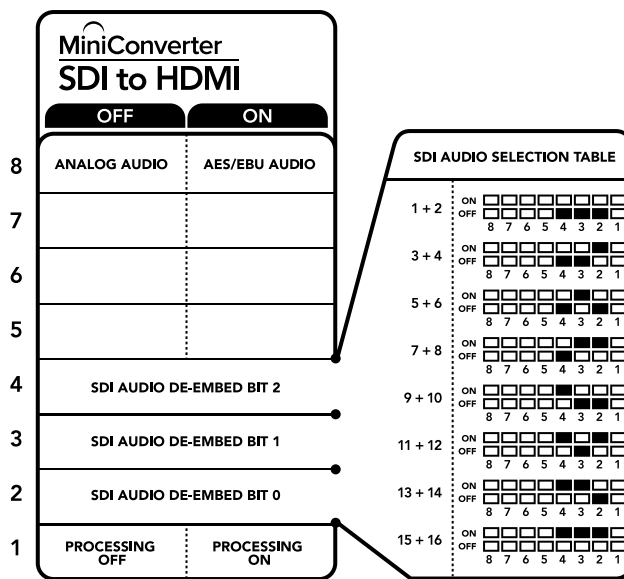





The switch legend on the base of your converter gives you all the information you need to change conversion settings.

### Mini Switch Settings Example

Experiment with the switches by setting your Blackmagic Mini Converter to de-embed SDI audio channels 1 and 2 and output to analog by setting switches 8, 4, 3 and 2 to the OFF position.

## SDI Audio Selection Table

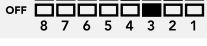
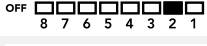
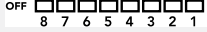
Audio Channels	Switch 4	Switch 3	Switch 2	Switch Diagram
1 and 2	OFF	OFF	OFF	ON OFF  8 7 6 5 4 3 2 1
3 and 4	OFF	OFF	ON	ON OFF  8 7 6 5 4 3 2 1
5 and 6	OFF	ON	OFF	ON OFF  8 7 6 5 4 3 2 1
7 and 8	OFF	ON	ON	ON OFF  8 7 6 5 4 3 2 1
9 and 10	ON	OFF	OFF	ON OFF  8 7 6 5 4 3 2 1
11 and 12	ON	OFF	ON	ON OFF  8 7 6 5 4 3 2 1
13 and 14	ON	ON	OFF	ON OFF  8 7 6 5 4 3 2 1
15 and 16	ON	ON	ON	ON OFF  8 7 6 5 4 3 2 1

## Blackmagic Converters Setup Settings

The Converters Setup utility can be used to change settings and update your Mini Converter's software. You can access these settings by moving between the 'video,' 'audio,' and 'about' tabs.

The 'about' tab is detailed in the 'changing settings' section in this manual.

The 'video' tab for Mini Converter SDI to HDMI contains the following settings.

### Processing menu

The 'clip video output to legal levels' checkbox controls clipping of your SDI input to ensure that it stays within HDMI legal levels and should be kept on by default.

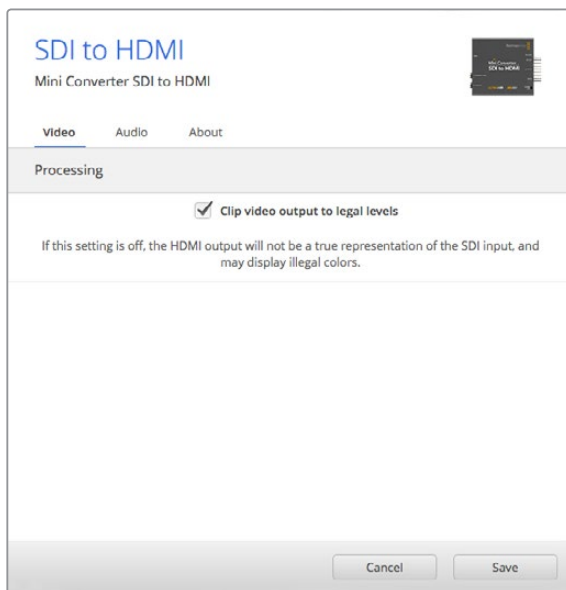

The 'clip video to legal levels' setting is checked by default. This ensures that your HDMI video output stays within legal levels.

The 'audio' tab for Mini Converter SDI to HDMI contains the following settings.

### Output Levels menu

This menu allows you to adjust the gain on the audio output. You can adjust audio levels independently per channel, or together by clicking the 'link' icon next to their sliders. To reset all audio levels back to 0 dB click the 'reset' button at the top of the 'output levels' menu.

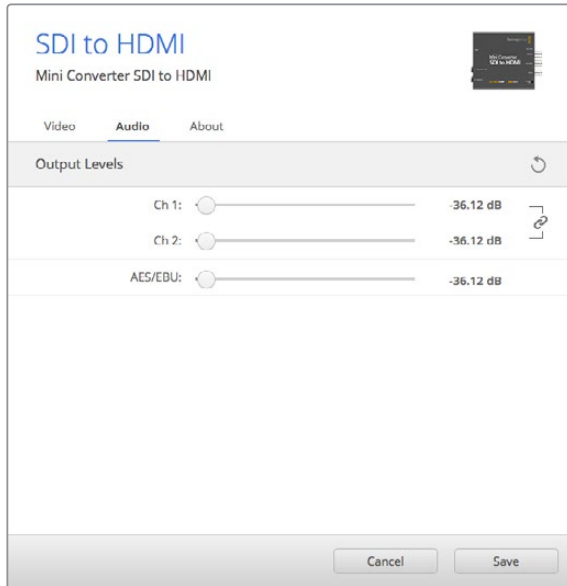

Use the 'audio' tab in Converters Setup to adjust audio levels.

### Mini Converter SDI to HDMI Block Diagram

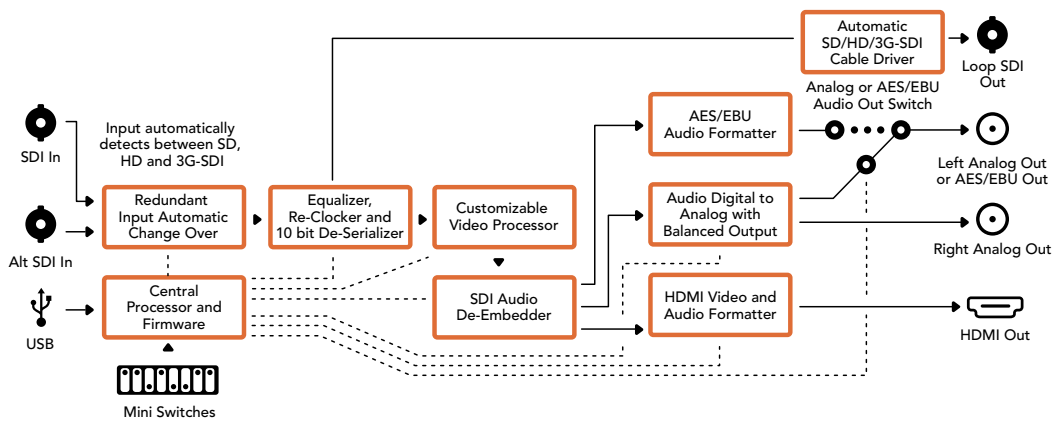

### Mini Converter SDI to HDMI 4K

With Mini Converter SDI to HDMI 4K and the SDI to HDMI 4K Heavy Duty model, you can connect a huge range of HDMI displays and video projectors to SDI based equipment. Your Mini Converter SDI to HDMI 4K automatically detects between SD/HD/3G/6G-SDI and converts to HDMI with embedded audio, plus balanced AES/EBU or analog audio out. The HDMI instant lock feature lets you lock the HDMI output so that changing sources using the same format is clean and glitch free. If your converter detects an HD monitor or TV connected to the HDMI output and has Ultra HD connected to the SDI input, the Ultra HD source will be automatically down converted so you can view the Ultra HD source on an HD monitor.

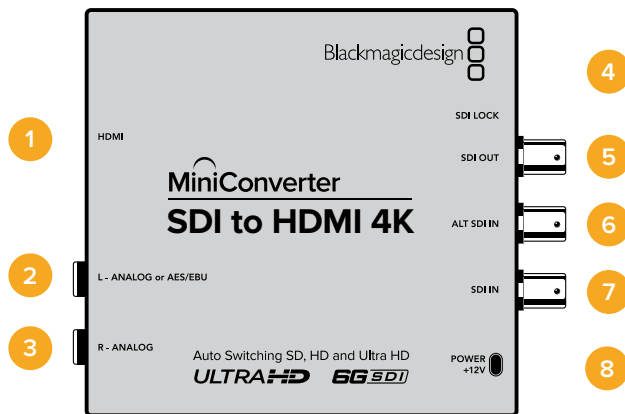

## Connectors

- 1 HDMI**  
HDMI type A video output.
- 2 L - ANALOG or AES/EBU**  
Balanced left channel analog audio, or AES/EBU digital audio output 1/4" jack connector.
- 3 R - ANALOG**  
Balanced right channel analog audio output 1/4" jack connector.
- 4 MINI-B USB PORT**  
Connects to the Converters Setup software via your Mac OS X or Windows computer. The Mini Converter's internal software is also updated using the USB port.
- 5 SDI OUT**  
SDI video output BNC connector.
- 6 ALT SDI IN**  
Redundant SDI input is provided as an optional back up.
- 7 SDI IN**  
Primary SDI input.
- 8 POWER +12V**  
12 volt power supply input.

## Switches

**TIP** On the Mini Converter Heavy Duty model, the switches are protected by a rubber dust cover. Simply lift the edge of the cover to access the switches.

Mini Converter SDI to HDMI 4K's switches provide the following settings:

### Switch 8 - Analog Audio, AES/EBU Audio

Set switch 8 to OFF to select balanced analog audio, or to ON for digital AES/EBU audio output.

### Switch 4 - SDI Audio De-Embed Bit 2

Switches 4, 3 and 2 are grouped together to provide 8 ON/OFF combinations. Having eight different combinations allows eight independent pairs of audio channels to be de-embedded from your SDI input and output to HDMI, analog or AES/EBU audio.

### Switch 3 - SDI Audio De-Embed Bit 1

See switch 4 description.

### Switch 2 - SDI Audio De-Embed Bit 0

See switch 4 description.

### Switch 1 - Processing Off - Processing On

This switch is not used.

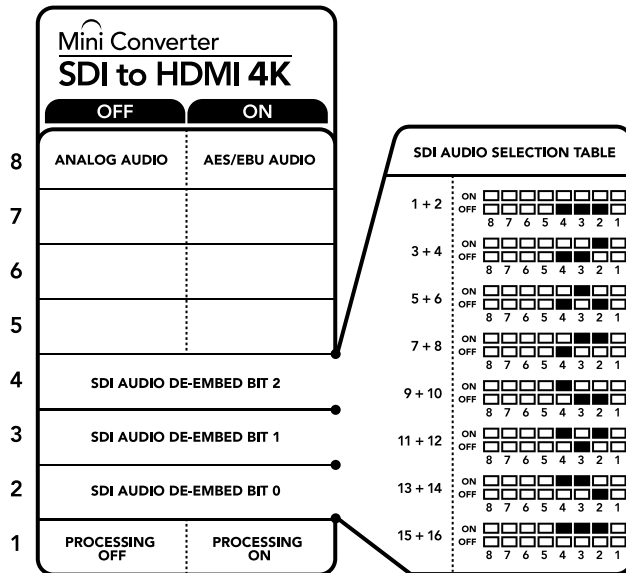

The switch legend on the base of your converter gives you all the information you need to change conversion settings.

### Mini Switch Settings Example

Experiment with the switches by setting your Blackmagic Mini Converter to de-embed SDI audio channels 1 and 2 and output to analog by setting switches 8, 4, 3 and 2 to the OFF position.

### SDI Audio Selection Table

Audio Channels	Switch 4	Switch 3	Switch 2	Switch Diagram
1 and 2	OFF	OFF	OFF	ON <input type="checkbox"/> <input type="checkbox"/> <input type="checkbox"/> <input type="checkbox"/> <input type="checkbox"/> <input type="checkbox"/> <input type="checkbox"/> <input type="checkbox"/> OFF <input type="checkbox"/> <input type="checkbox"/> <input type="checkbox"/> <input type="checkbox"/> <input checked="" type="checkbox"/> <input checked="" type="checkbox"/> <input checked="" type="checkbox"/> <input checked="" type="checkbox"/> 8 7 6 5 4 3 2 1
3 and 4	OFF	OFF	ON	ON <input type="checkbox"/> <input type="checkbox"/> <input type="checkbox"/> <input type="checkbox"/> <input type="checkbox"/> <input type="checkbox"/> <input type="checkbox"/> <input type="checkbox"/> OFF <input type="checkbox"/> <input type="checkbox"/> <input type="checkbox"/> <input type="checkbox"/> <input checked="" type="checkbox"/> <input checked="" type="checkbox"/> <input checked="" type="checkbox"/> <input checked="" type="checkbox"/> 8 7 6 5 4 3 2 1
5 and 6	OFF	ON	OFF	ON <input type="checkbox"/> <input type="checkbox"/> <input type="checkbox"/> <input type="checkbox"/> <input type="checkbox"/> <input type="checkbox"/> <input type="checkbox"/> <input type="checkbox"/> OFF <input type="checkbox"/> <input type="checkbox"/> <input checked="" type="checkbox"/> <input checked="" type="checkbox"/> <input checked="" type="checkbox"/> <input checked="" type="checkbox"/> <input checked="" type="checkbox"/> <input checked="" type="checkbox"/> 8 7 6 5 4 3 2 1
7 and 8	OFF	ON	ON	ON <input type="checkbox"/> <input type="checkbox"/> <input type="checkbox"/> <input type="checkbox"/> <input type="checkbox"/> <input type="checkbox"/> <input type="checkbox"/> <input type="checkbox"/> OFF <input type="checkbox"/> <input type="checkbox"/> <input checked="" type="checkbox"/> <input checked="" type="checkbox"/> <input checked="" type="checkbox"/> <input checked="" type="checkbox"/> <input checked="" type="checkbox"/> <input checked="" type="checkbox"/> 8 7 6 5 4 3 2 1
9 and 10	ON	OFF	OFF	ON <input type="checkbox"/> <input type="checkbox"/> <input type="checkbox"/> <input checked="" type="checkbox"/> <input checked="" type="checkbox"/> <input checked="" type="checkbox"/> <input checked="" type="checkbox"/> <input checked="" type="checkbox"/> OFF <input type="checkbox"/> <input type="checkbox"/> <input type="checkbox"/> <input type="checkbox"/> <input type="checkbox"/> <input type="checkbox"/> <input type="checkbox"/> <input type="checkbox"/> 8 7 6 5 4 3 2 1
11 and 12	ON	OFF	ON	ON <input type="checkbox"/> <input type="checkbox"/> <input type="checkbox"/> <input checked="" type="checkbox"/> <input checked="" type="checkbox"/> <input checked="" type="checkbox"/> <input checked="" type="checkbox"/> <input checked="" type="checkbox"/> OFF <input type="checkbox"/> <input type="checkbox"/> <input type="checkbox"/> <input type="checkbox"/> <input type="checkbox"/> <input type="checkbox"/> <input type="checkbox"/> <input type="checkbox"/> 8 7 6 5 4 3 2 1
13 and 14	ON	ON	OFF	ON <input type="checkbox"/> <input type="checkbox"/> <input type="checkbox"/> <input checked="" type="checkbox"/> <input checked="" type="checkbox"/> <input checked="" type="checkbox"/> <input checked="" type="checkbox"/> <input checked="" type="checkbox"/> OFF <input type="checkbox"/> <input type="checkbox"/> <input checked="" type="checkbox"/> <input checked="" type="checkbox"/> <input checked="" type="checkbox"/> <input checked="" type="checkbox"/> <input checked="" type="checkbox"/> <input checked="" type="checkbox"/> 8 7 6 5 4 3 2 1
15 and 16	ON	ON	ON	ON <input type="checkbox"/> <input type="checkbox"/> <input type="checkbox"/> <input checked="" type="checkbox"/> <input checked="" type="checkbox"/> <input checked="" type="checkbox"/> <input checked="" type="checkbox"/> <input checked="" type="checkbox"/> OFF <input type="checkbox"/> <input type="checkbox"/> <input checked="" type="checkbox"/> <input checked="" type="checkbox"/> <input checked="" type="checkbox"/> <input checked="" type="checkbox"/> <input checked="" type="checkbox"/> <input checked="" type="checkbox"/> 8 7 6 5 4 3 2 1



## Blackmagic Converters Setup Settings

The Converters Setup utility can be used to change settings and update your Mini Converter's software. You can access these settings by moving between the 'video,' 'audio,' and 'about' tabs.

The 'about' tab is detailed in the 'changing settings' section in this manual.

The 'video' tab for Mini Converter SDI to HDMI 4K contains the following settings.

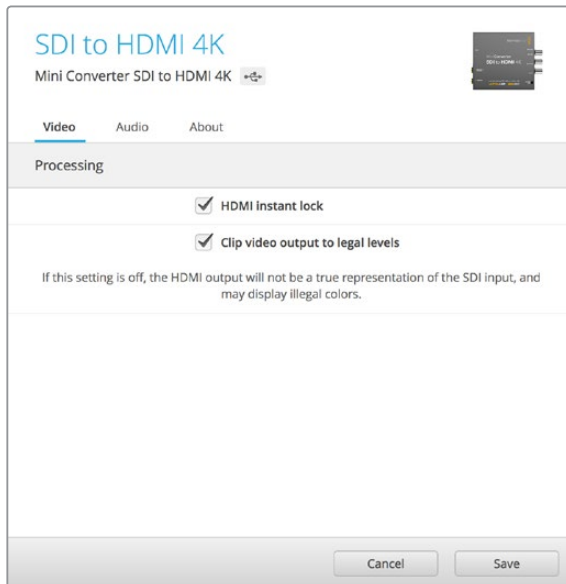

The 'clip video to legal levels' setting is checked by default. This ensures that your HDMI video output stays within legal levels.

### Processing menu

- **HDMI Instant Lock**

Select this checkbox to enable the HDMI instant lock feature. When HDMI instant lock is enabled, the HDMI output signal is kept active even when changing sources. This means your converter does not have to wait for the HDMI television or monitor to lock before displaying the video output as the HDMI signal is already locked. It's important to note that this feature only works when changing sources using the same video standard.

The HDMI instant lock feature can introduce a small delay in video and audio, so if you need zero delay in your converted output you can bypass the HDMI instant lock feature by deselecting the checkbox.

- **Clip Video Output to Legal Levels**

This checkbox controls clipping of your SDI input to ensure that it stays within HDMI legal levels and should be kept on by default.

### Output Levels menu

This menu allows you to adjust the gain on the audio output. You can adjust audio levels independently per channel, or together by clicking the 'link' icon next to their sliders. To reset all audio levels back to 0 dB click the 'reset' button at the top of the 'output levels' menu.

The 'audio' tab for Mini Converter SDI to HDMI 4K contains the following settings.

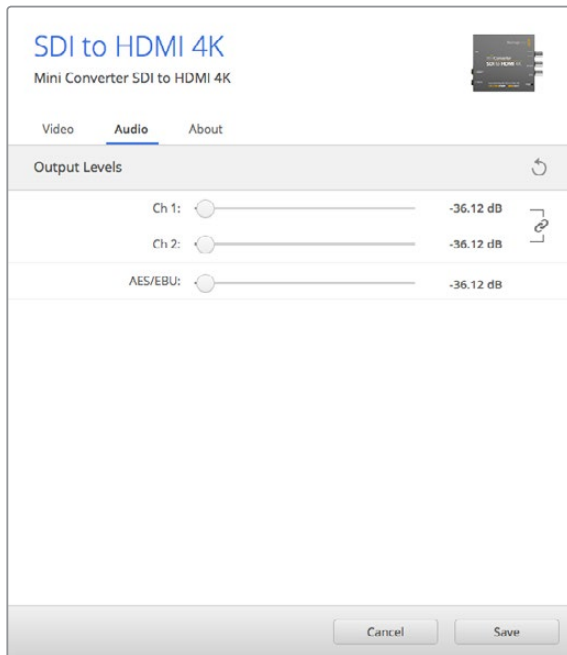

Use the 'audio' tab in Converters Setup to adjust audio levels.

### Mini Converter SDI to HDMI 4K Block Diagram

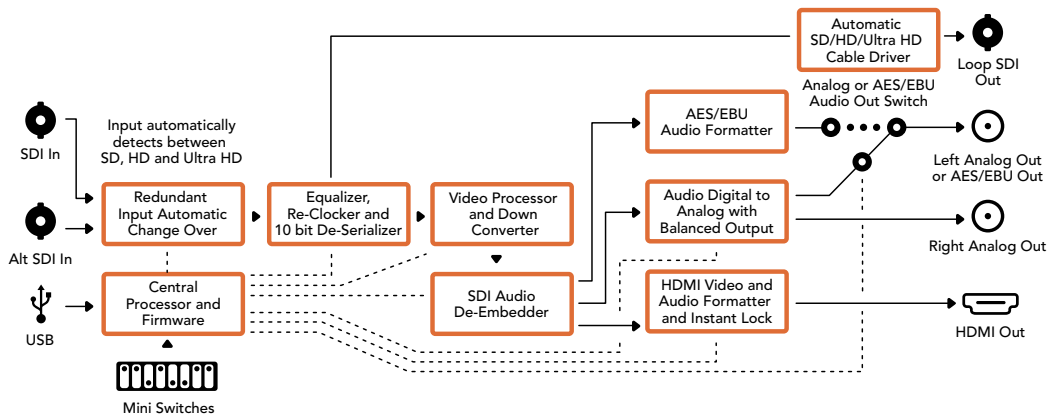

### Mini Converter SDI to HDMI 6G

With Mini Converter SDI to HDMI 6G, you can connect a huge range of HDMI displays and video projectors to SDI based equipment. Your Mini Converter SDI to HDMI 6G automatically detects between SD SDI, HD-SDI, 3G-SDI and 6G-SDI input sources and converts to HDMI with embedded audio, plus balanced AES/EBU or analog audio out.

The HDMI instant lock feature lets you lock the HDMI output so that changing sources using the same format is clean and glitch free. If your converter detects an HD monitor or TV connected to the HDMI output and has Ultra HD connected to the SDI input, the Ultra HD source will be automatically down converted so you can view the Ultra HD source on an HD monitor.

You can also load 3D LUTs for adding looks, grades, and color profiles to your converted output. The 3D LUT is a full 33 point hardware lookup table for greater accuracy with color manipulation and can even be used to accurately color calibrate consumer televisions so they can be used for critical color correction work. The 3D LUT also allows color space conversions so different color spaces can be used with various displays. Your Mini Converter SDI to HDMI 6G comes with two default LUTs, including color to monochrome and Blackmagic camera default color space to REC 709.

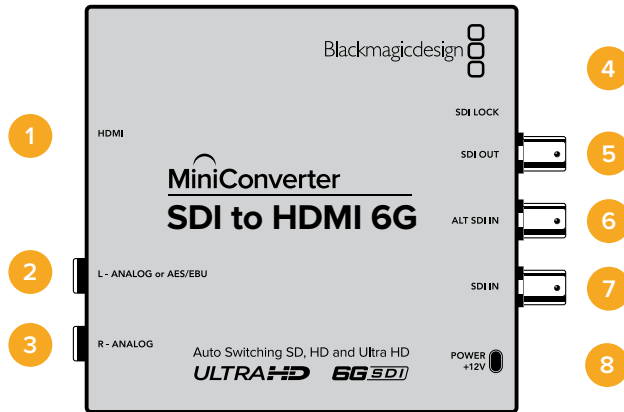

## Connectors

- 1 HDMI**  
HDMI type A video output.
- 2 L - ANALOG or AES/EBU**  
Balanced left channel analog audio, or AES/EBU digital audio output 1/4" jack connector.
- 3 R - ANALOG**  
Balanced right channel analog audio output 1/4" jack connector.
- 4 MINI-B USB PORT**  
Connects to the Converters Setup software via your Mac OS X or Windows computer. The Mini Converter's internal software is also updated using the USB port.
- 5 SDI OUT**  
SDI video output BNC connector
- 6 ALT SDI IN**  
Redundant SDI input is provided as an optional back up.
- 7 SDI IN**  
Primary SDI input.
- 8 POWER +12V**  
12 volt power supply input.

## Switches

Mini Converter SDI to HDMI 6G's switches provide the following settings:

### Switch 8 - Analog Audio, AES/EBU Audio

Set switch 8 to OFF to select balanced analog audio, or to ON for digital AES/EBU audio output.

### Switch 7 - LUT Off, LUT On

Set Switch 7 to OFF to disable the LUT, or to ON to enable the LUT.

### Switch 6 - LUT 1, LUT2

Set Switch 6 to OFF to select LUT 1, or to ON to select LUT 2.

### Switch 5 - LUT On Loop Off, LUT On Loop On

Set Switch 5 to OFF to select LUT On Loop Off, or to ON to select LUT On Loop On.

### Switch 4 - SDI Audio De-Embed Bit 2

Switches 4, 3 and 2 are grouped together to provide 8 ON/OFF combinations. Having eight different combinations allows eight independent pairs of audio channels to be de-embedded from your SDI input and output to HDMI, analog or AES/EBU audio.

### Switch 3 - SDI Audio De-Embed Bit 1

See switch 4 description.

### Switch 2 - SDI Audio De-Embed Bit 0

See switch 4 description.

### Switch 1 - HDMI Instant Lock Off, HDMI Instant Lock On

Set switch 1 to OFF to select HDMI Instant Lock Off, or to ON to select HDMI Instant Lock On.

When HDMI instant lock is enabled, the HDMI output signal is kept active even when changing sources. This means your converter does not have to wait for the HDMI television or monitor to lock before displaying the video output as the HDMI signal is already locked. It's important to note that this feature only works when changing sources using the same video standard.

The HDMI instant lock feature can introduce a small delay in video and audio, so if you need zero delay in your converted output you can bypass the HDMI instant lock feature by turning HDMI Instant Lock OFF.

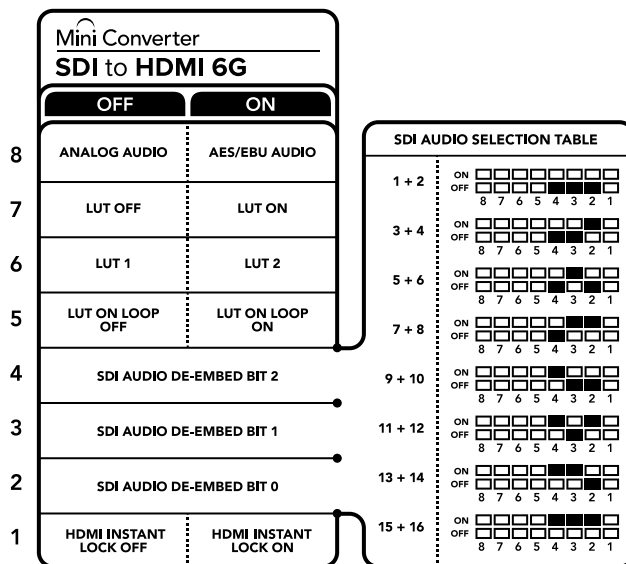

The switch legend on the base of your converter gives you all the information you need to change conversion settings

### Mini Switch Settings Example

Experiment with the switches by setting your Blackmagic Mini Converter to de-embed SDI audio channels 1 and 2 and output to analog by setting switches 8, 4, 3 and 2 to the OFF position.

## SDI Audio Selection Table

Audio Channels	Switch 4	Switch 3	Switch 2	Switch Diagram
1 and 2	OFF	OFF	OFF	
3 and 4	OFF	OFF	ON	
5 and 6	OFF	ON	OFF	
7 and 8	OFF	ON	ON	
9 and 10	ON	OFF	OFF	
11 and 12	ON	OFF	ON	
13 and 14	ON	ON	OFF	
15 and 16	ON	ON	ON	

## Blackmagic Converters Setup Settings

The Converters Setup utility can be used to change settings and update your Mini Converter's software. You can access these settings by moving between the 'video,' 'audio,' and 'about' tabs. The 'about' tab is detailed in the 'changing settings' section in this manual.

The 'video' tab for Mini Converter SDI to HDMI 6G contains the following settings.



The 'clip video output to legal levels' setting is checked by default. This ensures that your HDMI video output stays within legal levels.

## Processing menu

### ▪ 33 Point 3D LUT

Your Mini Converter SDI to HDMI 6G supports .cube LUT files that can be created using DaVinci Resolve software, or other color correction software that can export .cube files.

You can load 2 separate LUTs by clicking on the 'load' button for each LUT slot, selecting the desired .cube file from your computer, and clicking 'OK'. Click 'save' to confirm your settings. The LUT filename will appear next to each 'load' button so you know which LUT is being used for LUT 1 or LUT 2.

### ▪ What is a 3D LUT?

A 3D LUT, or '3D Lookup Table', is a file containing table of values that are used to modify the video colorspace to a new set of color values in a 3D cube space.

The color cube contains all the variations between the mix of each primary color, defined within three x, y, z spatial dimensions. This means the RGB channels in the SDI input video can be remapped to any other RGB output color in the HDMI video output. This is very powerful as it means any color can be mapped to any other color so you can perform very precise color adjustments for calibrating displays, or loading log gamma curves for display when working with different types of raw camera files on set where you want to see linear gamma.

To show how powerful 3D LUTs can be, one of the default LUTs loaded can convert your input video to black and white. This shows that all the input RGB colors are remapped via the 3D LUT to black and white RGB output values via the HDMI output. You can create your own 3D LUTs and upload them via the admin software and DaVinci Resolve even allows you to convert a color grade setting to a 3D LUT that you can then upload to your Mini Converter SDI to HDMI 6G. You can output the 3D LUT on the SDI video loop output so you could even use your Mini Converter as a dedicated 3D LUT color processor even if you don't use the HDMI output!

For more information on how to create a 3D LUT .cube file, refer to the DaVinci Resolve manual which you can download from the Blackmagic Design website at [www.blackmagicdesign.com/support](http://www.blackmagicdesign.com/support).

### ▪ Clip Video Output to Legal Levels

This checkbox controls clipping of your SDI input to ensure that it stays within HDMI legal levels and should be kept on by default.

## Output Levels menu

This menu allows you to adjust the gain on the audio output. You can adjust audio levels independently per channel, or together by clicking the 'link' icon next to their sliders. To reset all audio levels back to 0 dB click the 'reset' button at the top of the 'output levels' menu. The 'audio' tab for Mini Converter SDI to HDMI 6G contains the following settings.



Use the 'audio' tab in Converters Setup to adjust audio levels

### Mini Converter SDI to HDMI 6G Block Diagram

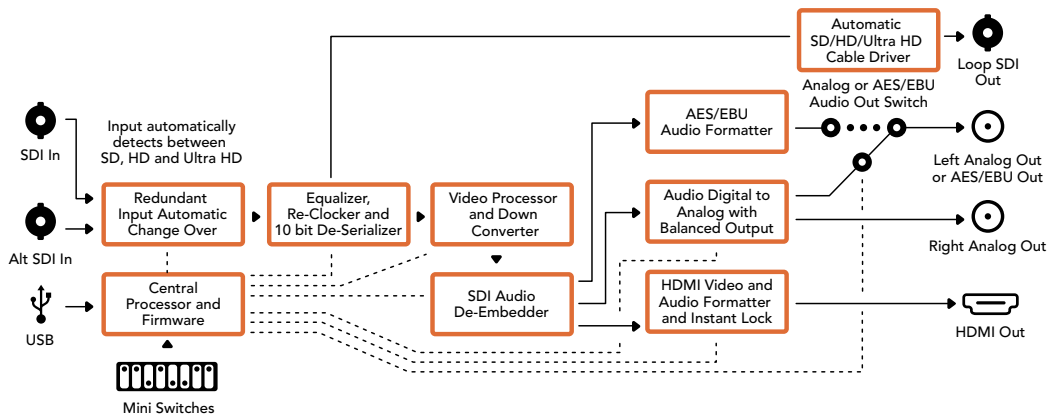

### Mini Converter HDMI to SDI

Your Mini Converter HDMI to SDI can convert HDMI outputs from devices such as HDV cameras and game consoles to SDI with the choice to embed audio from HDMI, AES/EBU or balanced analog audio inputs. This means you can send video signals from HDMI over SDI using the longest SDI cables. You can even add SDI outputs to computers with HDMI compatibility. This converter also includes HD to SD down conversion.

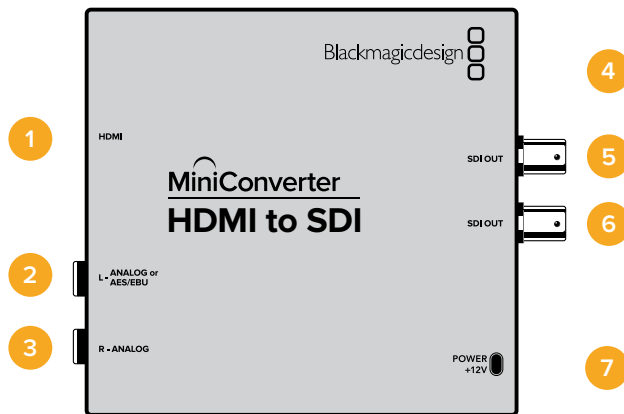

## Connectors

- 1 HDMI**  
HDMI type A video input.
- 2 L - ANALOG or AES/EBU**  
Balanced left channel analog audio or AES/EBU digital audio input on a 1/4" jack connector.
- 3 R - ANALOG**  
Balanced right channel analog audio input 1/4" jack connector.
- 4 MINI-B USB PORT**  
Connects to the Converters Setup software via your Mac OS X or Windows computer. The Mini Converter's internal software is also updated using the USB port.
- 5 SDI OUT**  
SDI video output on a BNC connector.
- 6 SDI OUT**  
Second SDI output.
- 7 POWER +12V**  
12 volt power supply input.

## Switches

Mini Converter HDMI to SDI's switches provide the following settings:

### Switch 8 - Analog Audio, AES/EBU Audio

Set switch 8 to OFF to select balanced analog audio, or to ON for digital AES/EBU audio input. To use these inputs Switch 7 must also be set to ON.

### Switch 7 - HDMI Audio - Input Audio

Set switch 7 to OFF to select embedded HDMI audio, or to ON for analog or AES/EBU audio.

### Switch 1 - Processing Off - Processing On

Down convert HD to SD with 3 types of aspect ratios by cycling through switch 1. For example, each time you cycle between OFF and On you apply anamorphic, center cut or letterbox aspect ratios. Leaving switch 1 set to OFF bypasses the down converter and outputs in HD.

When connected to the Blackmagic Converters Setup via USB, your down conversion settings are controlled by the software. If you want the converter to remember your software settings, disconnect from the computer, power cycle your converter and set your down conversion using mini switch 1.



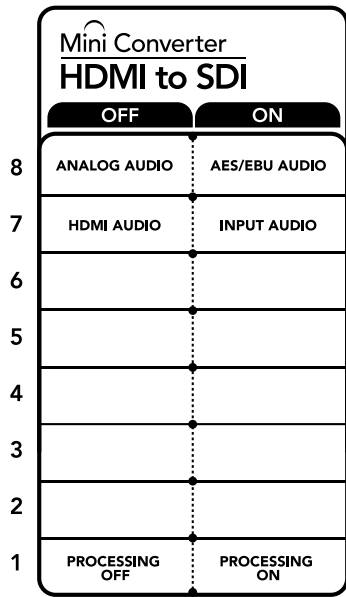

The switch legend on the base of your converter gives you all the information you need to change conversion settings.

## Blackmagic Converters Setup Settings

The Converters Setup utility can be used to change settings and update your Mini Converter's software. You can access these settings by moving between the 'video,' 'audio,' and 'about' tabs.

The 'about' tab is detailed in the 'changing settings' section in this manual.

The 'video' tab for Mini Converter HDMI to SDI contains the following settings.

### Processing menu

This menu lets you select the aspect ratio of content that is down converted from HD to SD. The options are 'letterbox,' 'anamorphic,' 'center cut,' or 'off.'

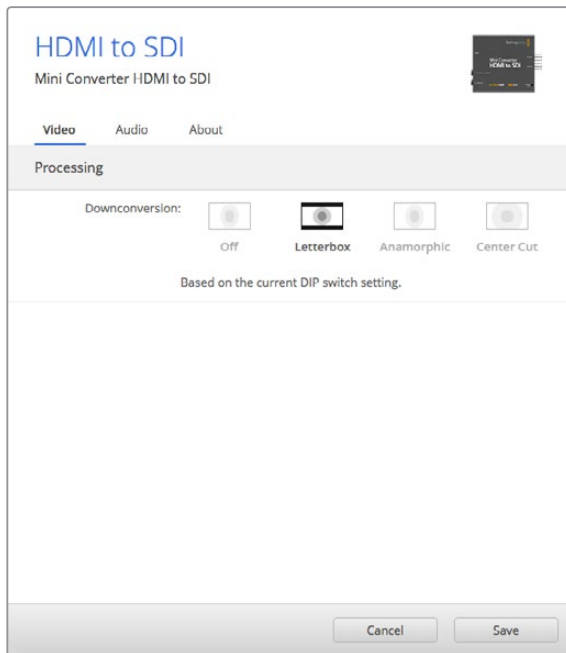

Use the 'video' tab in Converters Setup to adjust processing settings.

The 'audio' tab for Mini Converter HDMI to SDI contains the following settings.

### Input Levels menu

This menu allows you to adjust the gain on the audio input. You can adjust audio levels independently per channel, or together by clicking the 'link' icon next to their sliders. To reset all audio levels back to 0 dB click the 'reset' button at the top of the 'input levels' menu.

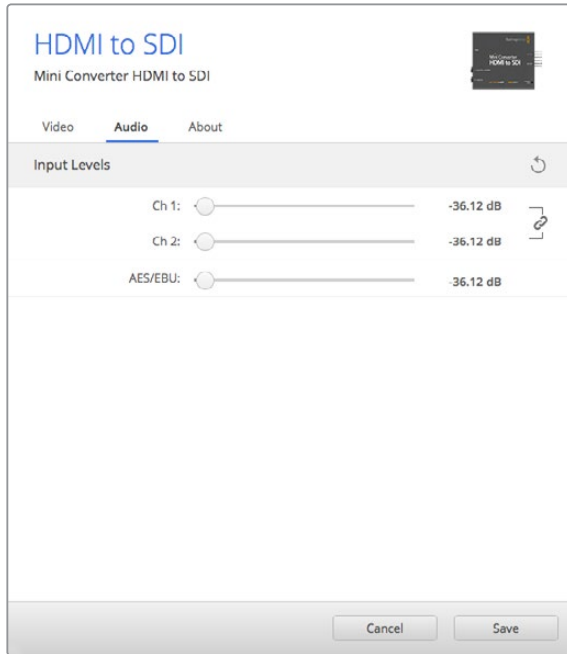

Use the 'audio' tab in Converters Setup to adjust audio levels.

### Mini Converter HDMI to SDI Block Diagram

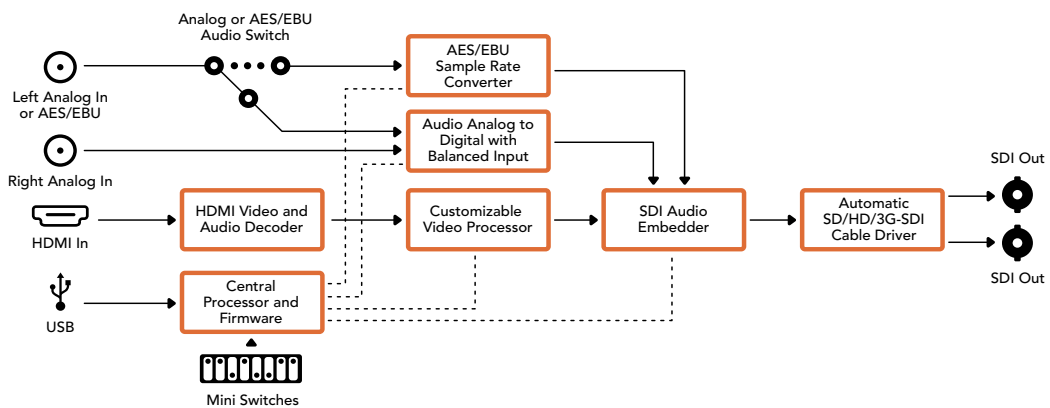

### Mini Converter HDMI to SDI 4K

Your Mini Converter HDMI to SDI 4K and the HDMI to SDI 4K Heavy Duty model can convert HDMI outputs from devices such as HDV cameras and game consoles to SDI with the choice to embed audio from HDMI, AES/EBU or balanced analog audio inputs. This means you can send video signals from HDMI over SDI using the longest SDI cables. You can even add SDI outputs to computers with HDMI compatibility.

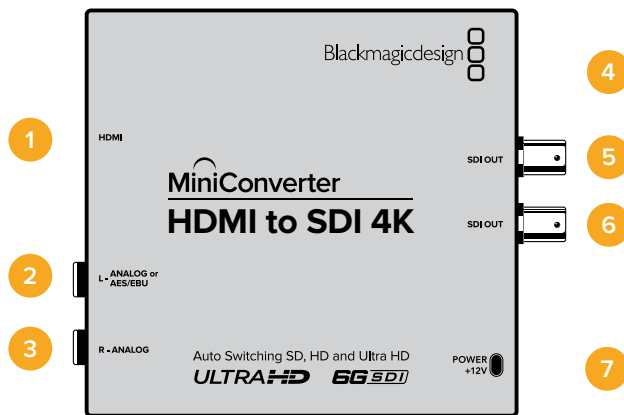

## Connectors

- 1 HDMI**  
HDMI type A video input.
- 2 L - ANALOG or AES/EBU**  
Balanced left channel analog audio or AES/EBU digital audio input 1/4" jack connector.
- 3 R - ANALOG**  
Balanced right channel analog audio input 1/4" jack connector.
- 4 MINI-B USB PORT**  
Connects to the Converters Setup software via your Mac OS X or Windows computer. The Mini Converter's internal software is also updated using the USB port.
- 5 SDI OUT**  
SDI video output BNC connector.
- 6 SDI OUT**  
Second SDI output.
- 7 POWER +12V**  
12 volt power supply input.

## Switches

**TIP** On the Mini Converter Heavy Duty model, the switches are protected by a rubber dust cover. Simply lift the edge of the cover to access the switches.

Mini Converter HDMI to SDI 4K's switches provide the following settings:

### Switch 8 - Analog Audio, AES/EBU Audio

Set switch 8 to OFF to select balanced analog audio, or to ON for digital AES/EBU audio input. To use these inputs Switch 7 must also be set to ON.

### Switch 7 - HDMI Audio - Input Audio

Set switch 7 to OFF to select embedded HDMI audio, or to ON for analog or AES/EBU audio.

### Switches 2, 1 - Select Format Bit 1,0

When connecting an HDMI source that can output Ultra HD and HD, you can set your converter to force the source output to one or the other. This can be helpful when you want to record or display your computer's desktop on SDI equipment in HD so it is larger and easy to view.

While it may appear like it's an up or down conversion setting, what your converter is actually doing is telling your source equipment to output Ultra HD or HD video so that your converter can then output the source video's native HD or Ultra HD resolution without up or down conversion.

To force your source video to HD, Ultra HD, or to let your converter automatically negotiate the optimum resolution with your source equipment, simply use combinations of switches 1 and 2.

The combination settings are shown below.

#### **AUTO - switch 1 to OFF, switch 2 to OFF.**

Your converter will negotiate an optimum HD or Ultra HD resolution with your source equipment based on its output capabilities.

#### **FORCE TO HD - switch 1 to OFF, switch 2 to ON.**

If your HDMI source equipment is capable of outputting HD and Ultra HD, your converter will instruct the source equipment to output HD video.

#### **FORCE TO ULTRA HD - Switch 1 to ON, Switch 2 to OFF.**

If your HDMI source equipment is capable of outputting HD and Ultra HD, your converter will instruct the source to output Ultra HD video.

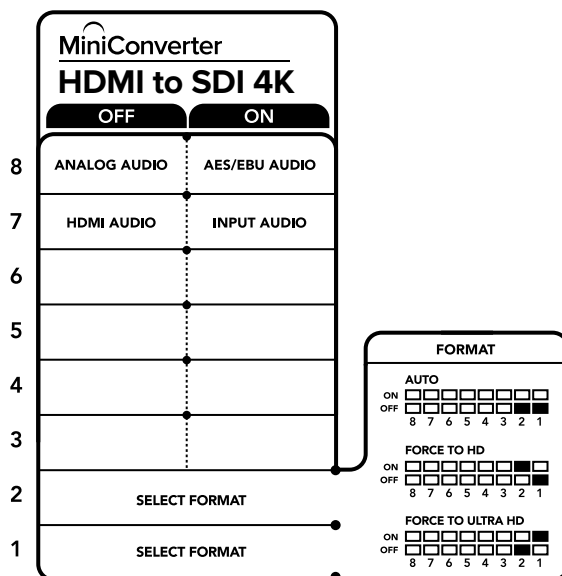

The switch legend on the base of your converter gives you all the information you need to change conversion settings.

## Blackmagic Converters Setup Settings

The Converters Setup utility can be used to change settings and update your Mini Converter's software. You can access these settings by moving between the 'audio,' and 'about' tabs.

The 'about' tab is detailed in the 'changing settings' section in this manual.

The 'audio' tab for Mini Converter HDMI to SDI 4K contains the following settings.

## Input Levels menu

This menu allows you to adjust the gain on the audio input. You can adjust audio levels independently per channel, or together by clicking the 'link' icon next to their sliders. To reset all audio levels back to 0 dB click the 'reset' button at the top of the 'input levels' menu.

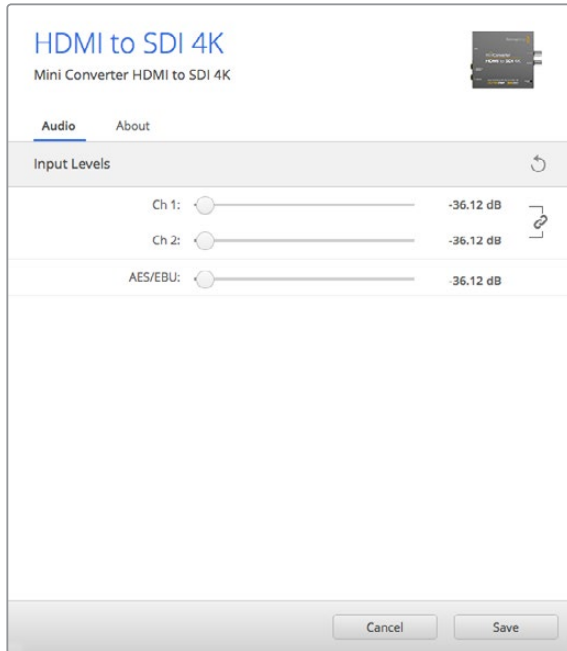

Use the 'audio' tab in Converters Setup to adjust audio levels.

## Mini Converter HDMI to SDI 4K Block Diagram

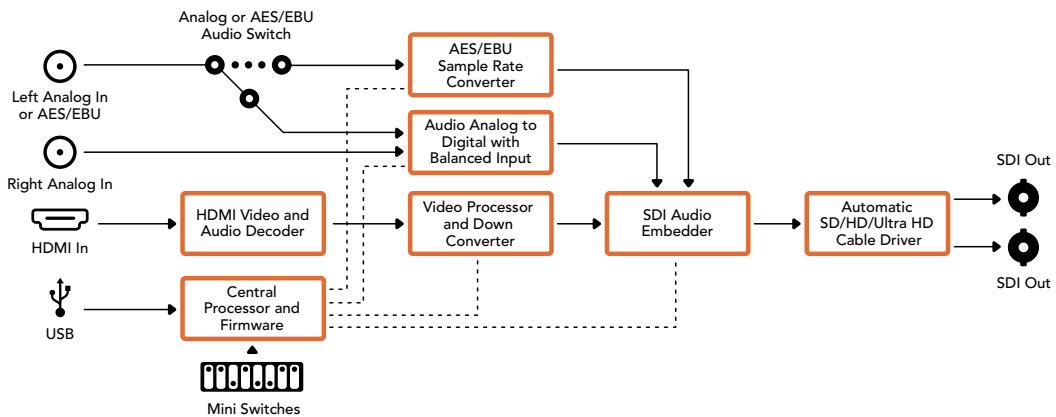

## Mini Converter HDMI to SDI 6G

Your Mini Converter HDMI to SDI 6G can convert HDMI outputs from devices such as HDV cameras and game consoles to SDI with the choice to embed audio from HDMI, AES/EBU or balanced analog audio inputs. This means you can send video signals from HDMI over SDI using the longest SDI cables. You can even add SDI outputs to computers with HDMI compatibility.

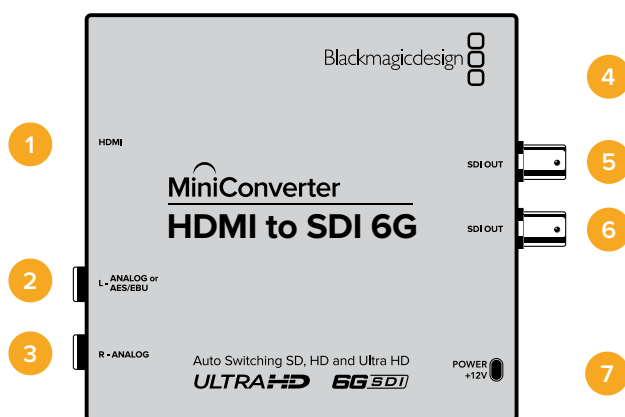

## Connectors

- 1 HDMI**  
HDMI type A video input.
- 2 L - ANALOG or AES/EBU**  
Balanced left channel analog audio or AES/EBU digital audio input 1/4" jack connector.
- 3 R - ANALOG**  
Balanced right channel analog audio input 1/4" jack connector.
- 4 MINI-B USB PORT**  
Connects to the Converters Setup software via your Mac OS X or Windows computer. The Mini Converter's internal software is also updated using the USB port.
- 5 SDI OUT**  
SDI video output BNC connector.
- 6 SDI OUT**  
Second SDI output.
- 7 POWER +12V**  
12 volt power supply input.

## Switches

Mini Converter HDMI to SDI 6G's switches provide the following settings:

### Switch 8 - Analog Audio, AES/EBU Audio

Set switch 8 to OFF to select balanced analog audio, or to ON for digital AES/EBU audio input. To use these inputs Switch 7 must also be set to ON.

### Switch 7 - HDMI Audio, Input Audio

Set switch 7 to OFF to select embedded HDMI audio, or to ON for analog or AES/EBU audio.

### Switch 6 - 3G Level B Output (Normal), 3G Level A Output

Set switch 6 to OFF to select 3G Level B Output, or to ON to select 3G Level A Output

### Switches 2, 1 - Select Format Bit 1,0

When connecting an HDMI source that can output Ultra HD and HD, you can set your converter to force the source output to one or the other. This can be helpful when you want to record or display your computer's desktop on SDI equipment in HD so it is larger and easy to view.

While it may appear like it's an up or down conversion setting, what your converter is actually doing is telling your source equipment to output Ultra HD or HD video so that your converter can then output the source video's native HD or Ultra HD resolution without up or down conversion.

To force your source video to HD, Ultra HD, or to let your converter automatically negotiate the optimum resolution with your source equipment, simply use combinations of switches 1 and 2.

The combination settings are shown below.

**AUTO - switch 1 to OFF, switch 2 to OFF**

Your converter will negotiate an optimum HD or Ultra HD resolution with your source equipment based on its output capabilities.

**FORCE TO HD - switch 1 to OFF, switch 2 to ON**

If your HDMI source equipment is capable of outputting HD and Ultra HD, your converter will instruct the source equipment to output HD video.

**FORCE TO ULTRA HD - Switch 1 to ON, Switch 2 to OFF**

If your HDMI source equipment is capable of outputting HD and Ultra HD, your converter will instruct the source to output Ultra HD video.

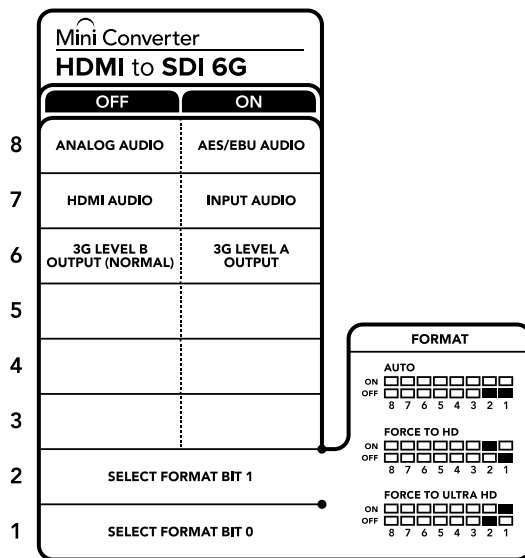

The switch legend on the base of your converter gives you all the information you need to change conversion settings

## Blackmagic Converters Setup Settings

The Converters Setup utility can be used to change settings and update your Mini Converter's software. You can access these settings by moving between the 'audio,' and 'about' tabs. The 'about' tab is detailed in the 'changing settings' section in this manual. The 'audio' tab for Mini Converter HDMI to SDI 6G contains the following settings.

### Input Levels menu

This menu allows you to adjust the gain on the audio input. You can adjust audio levels independently per channel, or together by clicking the 'link' icon next to their sliders. To reset all audio levels back to 0 dB click the 'reset' button at the top of the 'input levels' menu.



Use the 'audio' tab in Converters Setup to adjust audio levels.

### Mini Converter HDMI to SDI 6G Block Diagram

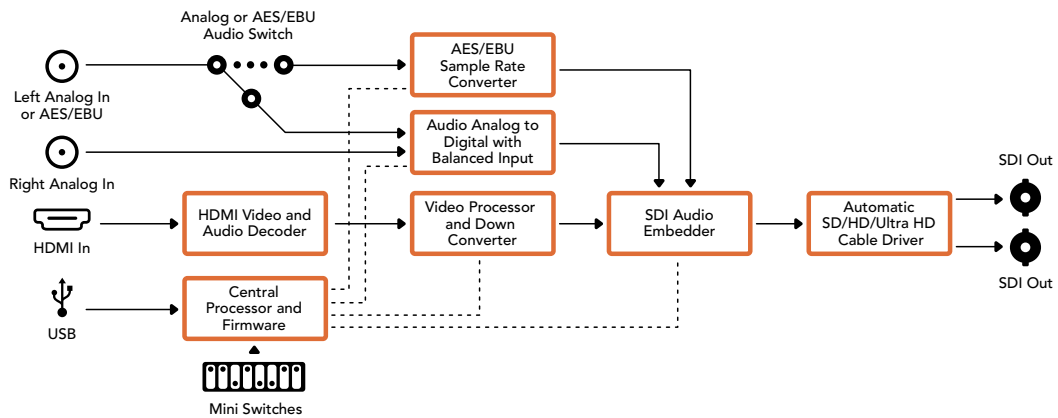

### Mini Converter SDI to Analog

Your Blackmagic Mini Converter SDI to Analog converts from SD/HD-SDI to analog component, NTSC and PAL video out, plus balanced AES/EBU and analog audio out. Your converter easily connects to analog video monitors and decks such as Betacam SP and VHS. A hardware down converter lets you connect HD-SDI video to SD analog equipment. You can even output pairs of analog audio from 16 de-embedded SDI audio channels.



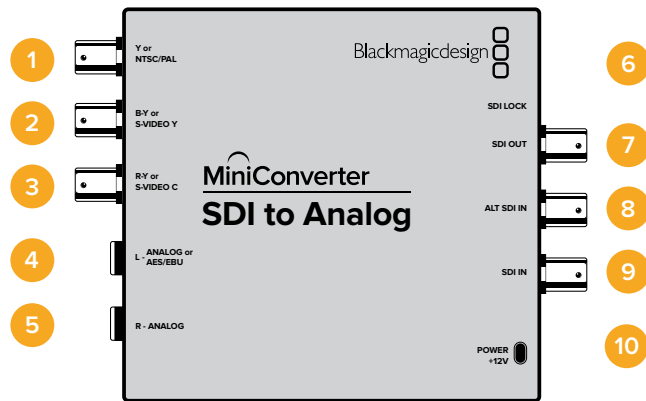

## Connectors

- 1 Y or NTSC/PAL**  
Analog component Y, or composite NTSC/PAL output on a BNC connector.
- 2 B-Y or S-VIDEO Y**  
Analog component B-Y, or S-Video Y output BNC connector.
- 3 R-Y or S-VIDEO C**  
Analog component R-Y, or S-Video C output BNC connector.
- 4 L - ANALOG or AES/EBU**  
Balanced left channel analog audio, or AES/EBU digital audio output on a 1/4" jack connector.
- 5 R - ANALOG**  
Balanced right channel analog audio output 1/4" jack connector.
- 6 MINI-B USB PORT**  
Connects to the Converters Setup software via your Mac OS X or Windows computer. The Mini Converter's internal software is also updated using the USB port.
- 7 SDI OUT**  
SDI video output on a BNC connector.
- 8 ALT SDI IN**  
Redundant SDI input is provided as an optional back up.
- 9 SDI IN**  
Primary SDI input.
- 10 POWER +12V**  
12 volt power supply input.

## Switches

### Switch 8 - Analog Audio, AES/EBU Audio

Set switch 8 to OFF to select balanced analog audio, or to ON for digital AES/EBU audio output.

### Switch 7 - 7.5 IRE - 0.0 IRE

The USA and countries using NTSC with 7.5 setup should set switch 7 to OFF. If you're working in countries not using 7.5 setup, set switch 7 to ON. This setting only affects composite or S-Video outputs.

### Switch 6 - SMPTE Levels - Betacam Levels

Set switch 6 to OFF for SMPTE levels, or ON for Betacam levels. SMPTE levels are more common and even Betacam SP decks can use SMPTE levels, so only switch this to Betacam if you are sure that Betacam levels are being used.

### Switch 5 - Component, Composite or S-Video

Set switch 5 to OFF to select analog component video output, or ON for composite and S-Video outputs.

To display the HD video input on the S-Video and composite outputs, down conversion must be set to ON. Component analog video supports both HD and SD video.

### Switch 4 - SDI Audio De-Embed Bit 2

Switches 4, 3 and 2 are grouped together to provide 8 ON/OFF combinations. Having eight different combinations allows eight independent pairs of audio channels to be de-embedded from your SDI input.

### Switch 3 - SDI Audio De-Embed Bit 1

See switch 4 description.

### Switch 2 - SDI Audio De-Embed Bit 0

See switch 4 description.

### Switch 1 - Processing Off - Processing On

Down convert HD to SD with 3 types of aspect ratios by cycling through switch 1. For example, each time you cycle between Off and On you apply anamorphic, center cut or letterbox aspect ratios. Leaving switch 1 set to OFF bypasses the down converter and outputs in HD.

When connected to Blackmagic Converters Setup via USB, your down conversion settings are controlled by the software. If you want the converter to remember your software settings, disconnect from the computer, power cycle your converter and set your down conversion using switch 1.

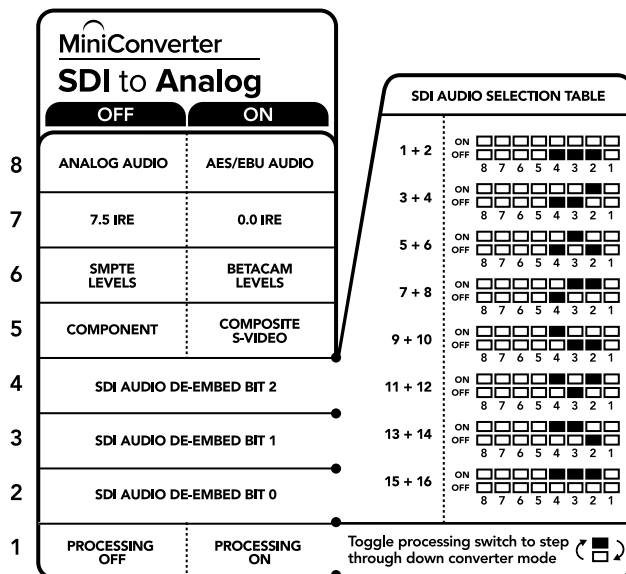

The switch legend on the base of your converter gives you all the information you need to change conversion settings.

### Mini Switch Settings Example

Experiment with the switches by setting your Blackmagic Mini Converter to output high definition component video and analog audio channels 1 and 2 by setting switches 8, 5, 4, 3 and 2 to the OFF position.

## SDI Audio Selection Table

Audio Channels	Switch 4	Switch 3	Switch 2	Switch Diagram
1 and 2	OFF	OFF	OFF	
3 and 4	OFF	OFF	ON	
5 and 6	OFF	ON	OFF	
7 and 8	OFF	ON	ON	
9 and 10	ON	OFF	OFF	
11 and 12	ON	OFF	ON	
13 and 14	ON	ON	OFF	
15 and 16	ON	ON	ON	

## Blackmagic Converters Setup Settings

The Converters Setup utility can be used to change settings and update your Mini Converter's software. You can access these settings by moving between the 'video,' 'audio,' and 'about' tabs.

The 'about' tab is detailed in the 'changing settings' section in this manual.

The 'video' tab for Mini Converter SDI to Analog contains the following settings.

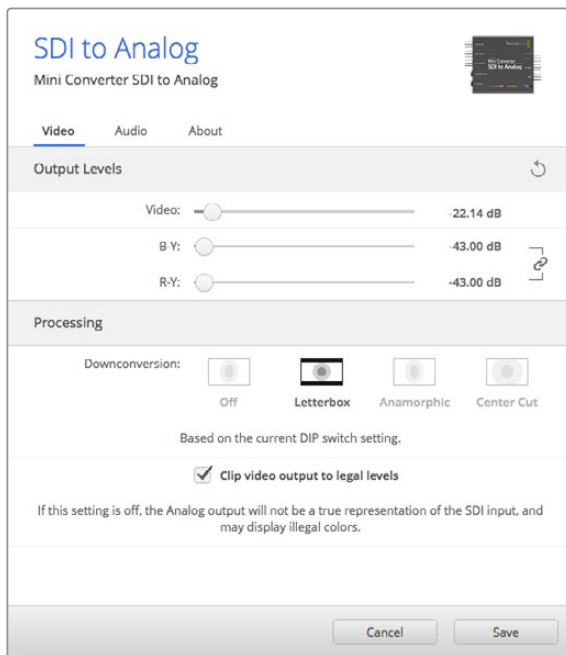

Use the 'video' tab in Converters Setup to adjust analog video levels and processing settings.

## Processing menu

This menu allows you to set the aspect ratio of down converted video. The options are letterbox, anamorphic, center cut or no processing.

The 'clip video output to legal levels' checkbox controls clipping of your SDI input to ensure that it stays within HDMI legal levels and should be kept on by default.

## Output Levels menu

This lets you set the luminance and chroma levels, and the B-Y and R-Y component levels independently.

The 'audio' tab for Mini Converter SDI to Analog contains the following settings.

## Output Levels menu

This menu allows you to adjust the gain on the audio output. You can adjust audio levels independently per channel, or together by clicking the 'link' icon next to their sliders. To reset all audio levels back to 0 dB click the 'reset' button at the top of the 'output levels' menu.

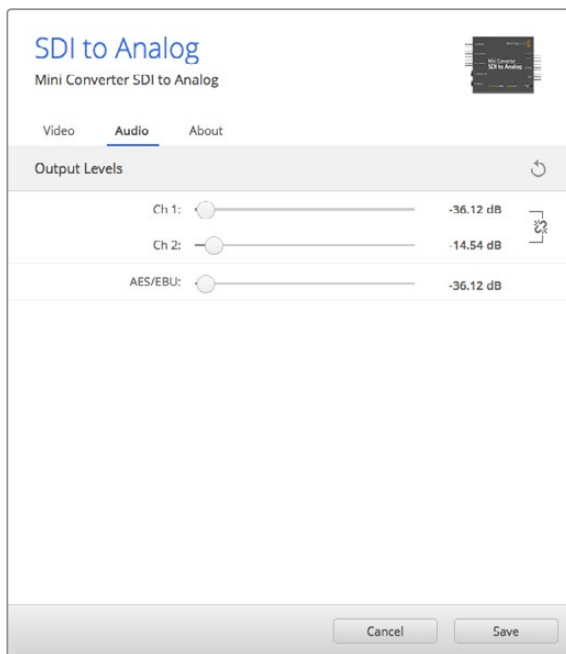

Use the 'audio' tab in Converters Setup to adjust analog audio levels.

## Mini Converter SDI to Analog Block Diagram

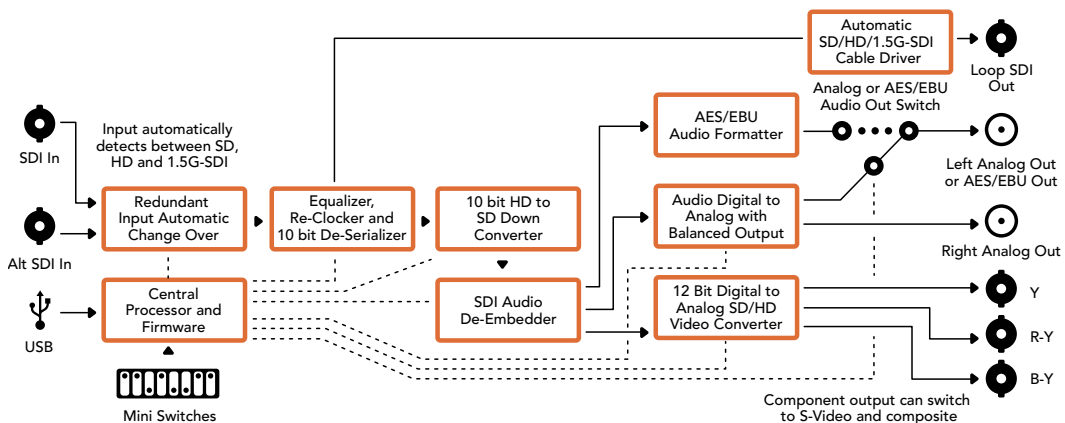

## Mini Converter SDI to Analog 4K

Your Mini Converter SDI to Analog 4K and the SDI to Analog 4K Heavy Duty model can convert from SD/HD/3G/6G-SDI to analog component, NTSC and PAL video out, plus balanced AES/EBU and analog audio out. This down converter lets you connect up to 6G-SDI video to SD or HD analog equipment and easily connects to video monitors and decks such as Betacam SP and VHS. You can even output pairs of analog audio from 16 de-embedded SDI audio channels.

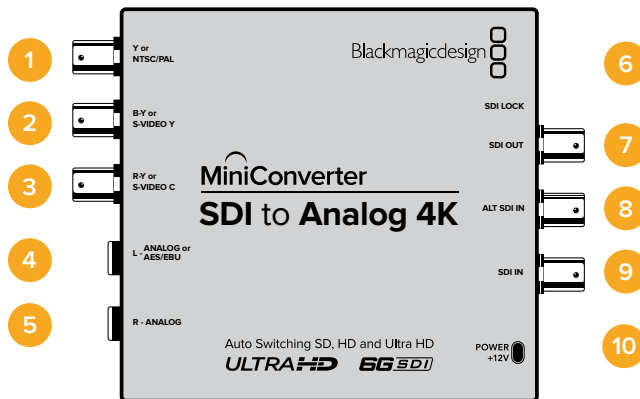

## Connectors

- 1 Y or NTSC/PAL**  
Analog component Y or composite NTSC/PAL output BNC connector.
- 2 B-Y or S-VIDEO Y**  
Analog component B-Y, or S-Video Y output BNC connector.
- 3 R-Y or S-VIDEO C**  
Analog component R-Y, or S-Video C output BNC connector.
- 4 L - ANALOG or AES/EBU**  
Balanced left channel analog audio, or AES/EBU digital audio output 1/4" jack connector.
- 5 R - ANALOG**  
Balanced right channel analog audio output 1/4" jack connector.
- 6 MINI-B USB PORT**  
Connects to the Converters Setup software via your Mac OS X or Windows computer. The Mini Converter's internal software is also updated using the USB port.
- 7 SDI OUT**  
SDI video output BNC connector.
- 8 ALT SDI IN**  
Redundant SDI input is provided as an optional back up.
- 9 SDI IN**  
Primary SDI input.
- 10 POWER +12V**  
12 volt power supply input.

## Switches

**TIP** On the Mini Converter Heavy Duty model, the switches are protected by a rubber dust cover. Simply lift the edge of the cover to access the switches.

Mini Converter SDI to Analog 4K's switches provide the following settings:

### **Switch 8 - Analog Audio, AES/EBU Audio**

Set switch 8 to OFF to select balanced analog audio, or to ON for digital AES/EBU audio output.

### **Switch 7 - 7.5 IRE - 0.0 IRE**

The USA and countries using NTSC with 7.5 setup should set switch 7 to OFF. If you're working in countries not using 7.5 setup, set switch 7 to ON. This setting only affects composite or S-Video outputs.

### **Switch 6 - SMPTE Levels - Betacam Levels**

Set switch 6 to OFF for SMPTE levels, or ON for Betacam levels. SMPTE levels are more common and even Betacam SP decks can use SMPTE levels, so only switch this to Betacam if you are sure that Betacam levels are being used.

### **Switch 5 - Component, Composite or S-Video**

Set switch 5 to OFF to select analog component video output, or ON for composite and S-Video outputs.

To display the HD video input as SD on the S-Video and composite outputs, down conversion must be set to ON. Component analog video supports both HD and SD video.

### **Switch 4, 3 and 2 - SDI Audio De-Embed**

Switches 4, 3 and 2 are grouped together to provide 8 ON/OFF combinations. Having eight different combinations allows eight independent pairs of audio channels to be de-embedded from your SDI input.

### **Switch 1 - Processing Off - Processing On**

Down conversion with 3 types of aspect ratios by cycling through switch 1. Each time you cycle between Off and On you apply anamorphic, center cut or letterbox aspect ratios.

For both HD and Ultra HD input, set switch to OFF to output HD analog via the component outputs.

Set switch to ON and Ultra HD input downconverts to either analog PAL/NTSC or HD component depending on the other switch settings. 4K DCI will be cropped on the component HD output.

An ON setting with HD input will be downconverted to analog PAL/NTSC or component depending on the other switch settings.

When connected to Blackmagic Converters Setup via USB, your down conversion settings are controlled by the software. If you want the converter to remember your software settings, disconnect from the computer, power cycle your converter and set your down conversion using switch 1.

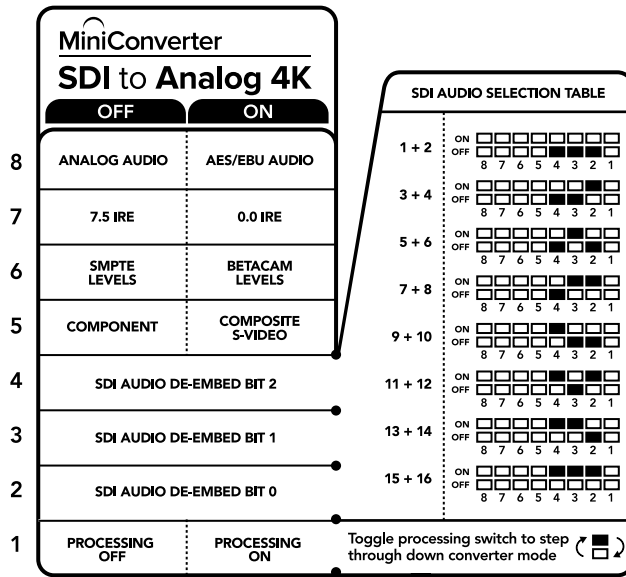

The switch legend on the base of your converter gives you all the information you need to change conversion settings.

### Mini Switch Settings Example:

Experiment with the switches by setting your Blackmagic Mini Converter to output high definition component video and analog audio channels 1 and 2 by setting switches 8, 5, 4, 3 and 2 to the OFF position.

### Audio Selection Table

Audio Channels	Switch 4	Switch 3	Switch 2	Switch Diagram
1 and 2	OFF	OFF	OFF	ON OFF <input type="checkbox"/> <input type="checkbox"/> <input type="checkbox"/> <input type="checkbox"/> <input type="checkbox"/> <input type="checkbox"/> <input type="checkbox"/> <input type="checkbox"/> 8 7 6 5 4 3 2 1
3 and 4	OFF	OFF	ON	ON OFF <input type="checkbox"/> <input type="checkbox"/> <input type="checkbox"/> <input type="checkbox"/> <input type="checkbox"/> <input type="checkbox"/> <input type="checkbox"/> <input checked="" type="checkbox"/> 8 7 6 5 4 3 2 1
5 and 6	OFF	ON	OFF	ON OFF <input type="checkbox"/> <input type="checkbox"/> <input type="checkbox"/> <input type="checkbox"/> <input checked="" type="checkbox"/> <input type="checkbox"/> <input type="checkbox"/> <input type="checkbox"/> 8 7 6 5 4 3 2 1
7 and 8	OFF	ON	ON	ON OFF <input type="checkbox"/> <input type="checkbox"/> <input type="checkbox"/> <input type="checkbox"/> <input checked="" type="checkbox"/> <input checked="" type="checkbox"/> <input type="checkbox"/> <input type="checkbox"/> 8 7 6 5 4 3 2 1
9 and 10	ON	OFF	OFF	ON OFF <input type="checkbox"/> <input type="checkbox"/> <input type="checkbox"/> <input checked="" type="checkbox"/> <input type="checkbox"/> <input type="checkbox"/> <input type="checkbox"/> <input type="checkbox"/> 8 7 6 5 4 3 2 1
11 and 12	ON	OFF	ON	ON OFF <input type="checkbox"/> <input type="checkbox"/> <input type="checkbox"/> <input checked="" type="checkbox"/> <input checked="" type="checkbox"/> <input type="checkbox"/> <input type="checkbox"/> 8 7 6 5 4 3 2 1
13 and 14	ON	ON	OFF	ON OFF <input type="checkbox"/> <input type="checkbox"/> <input type="checkbox"/> <input checked="" type="checkbox"/> <input checked="" type="checkbox"/> <input type="checkbox"/> <input type="checkbox"/> 8 7 6 5 4 3 2 1
15 and 16	ON	ON	ON	ON OFF <input type="checkbox"/> <input type="checkbox"/> <input type="checkbox"/> <input checked="" type="checkbox"/> <input checked="" type="checkbox"/> <input checked="" type="checkbox"/> <input checked="" type="checkbox"/> 8 7 6 5 4 3 2 1

## Blackmagic Converters Setup Settings

The Converters Setup utility can be used to change settings and update your Mini Converter's software. You can access these settings by moving between the 'video,' 'audio,' and 'about' tabs.

The 'about' tab is detailed in the 'changing settings' section in this manual.

The 'video' tab for Mini Converter SDI to Analog 4K contains the following settings.

### Output Levels menu

This lets you set the luminance and chroma levels, and the B-Y and R-Y component levels independently.

### Processing menu

This menu allows you to set the aspect ratio of down converted video. The options are letterbox, anamorphic, center cut or no processing.

The 'clip video output to legal levels' checkbox controls clipping of your SDI input to ensure that it stays within HDMI egal levels and should be kept on by default.

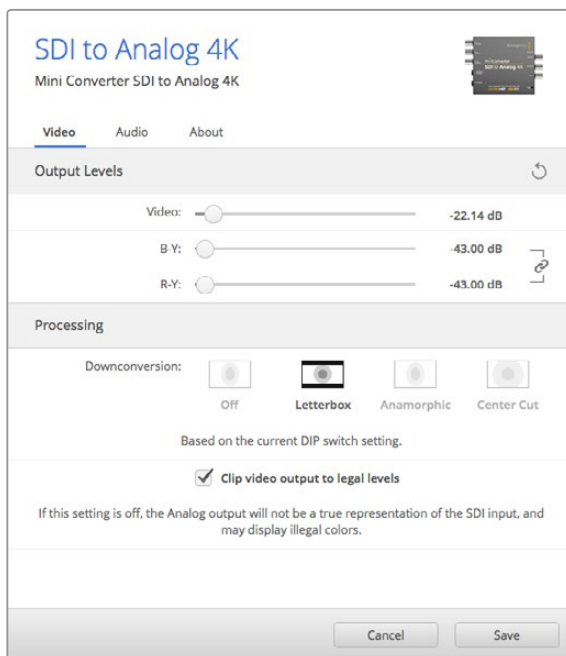

Use the 'video' tab in Converters Setup to adjust analog video levels and processing settings.

The 'audio' tab for Mini Converter SDI to Analog 4K contains the following settings.

### Output Levels menu

This menu allows you to adjust the gain on the audio input. You can adjust audio levels independently per channel, or together by clicking the 'link' icon next to their sliders. To reset all audio levels back to 0 dB click the 'reset' button at the top of the 'output levels' menu.



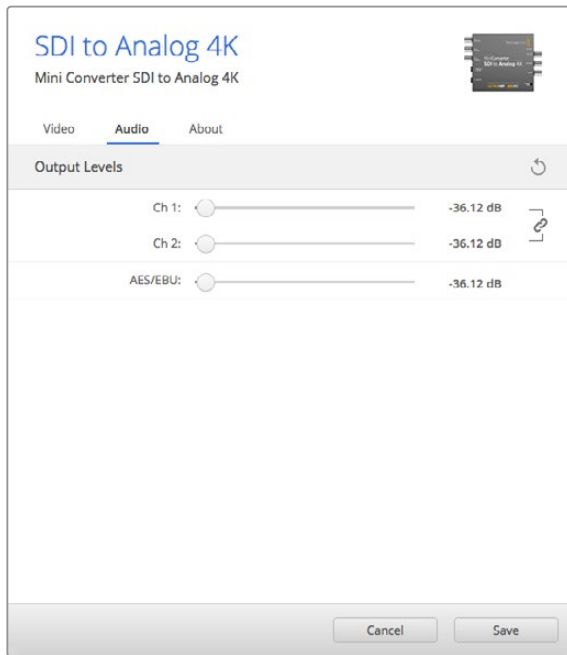

Use the 'audio' tab in Converters Setup to adjust analog audio levels.

### Mini Converter SDI to Analog 4K Block Diagram

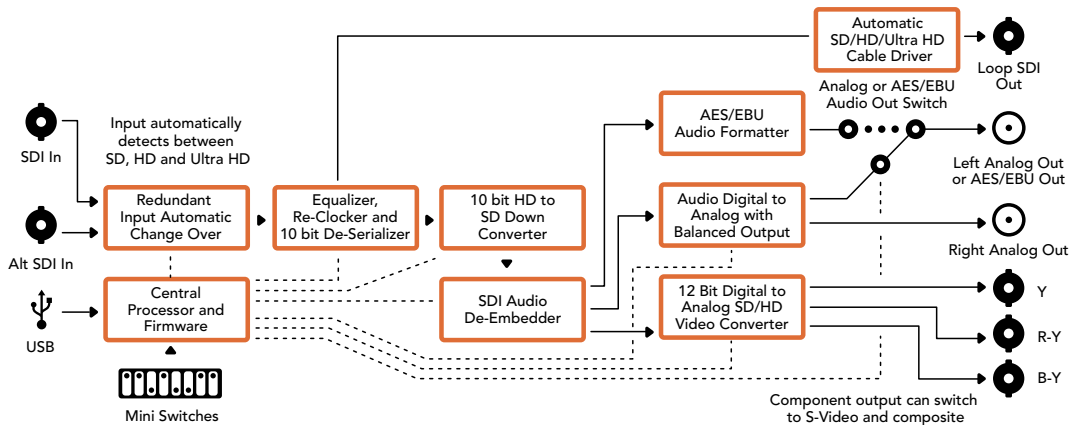

### Mini Converter Analog to SDI

With your Mini Converter Analog to SDI and the Analog to SDI Heavy Duty model you can convert video and audio from analog equipment such as Betacam SP decks, HDV cameras and game consoles to SD/HD-SDI video. A choice of analog and digital formats is supported, including component SD/HD, S-Video, or composite NTSC and PAL. The converter's HD-SDI outputs include the option to embed digital AES/EBU or analog audio.



## Connectors

- 1 Y or NTSC/PAL**  
Analog component Y, or composite NTSC/PAL input BNC connector.
- 2 B-Y or S-VIDEO Y**  
Analog component B-Y, or S-Video Y input BNC connector.
- 3 R-Y or S-VIDEO C**  
Analog component R-Y, or S-Video C input BNC connector.
- 4 L - ANALOG or AES/EBU**  
Balanced left channel analog audio, or AES/EBU digital audio input 1/4" jack connector.
- 5 R - ANALOG**  
Balanced right channel analog audio input 1/4" jack connector.
- 6 MINI-B USB PORT**  
Connects to the Converters Setup software via your Mac OS X or Windows computer. The Mini Converter's internal software is also updated using the USB port.
- 7 SDI OUT**  
SDI video output BNC connector.
- 8 SDI OUT**  
Second SDI output.
- 9 POWER +12V**  
12 volt power supply input.

## Switches

**TIP** On the Mini Converter Heavy Duty model, the switches are protected by a rubber dust cover. Simply lift the edge of the cover to access the switches.

Mini Converter Analog to SDI's switches provide the following settings:

### **Switch 8 - Analog Audio, AES/EBU Audio**

Set switch 8 to OFF to select balanced analog audio, or to ON for digital AES/EBU audio input.

### Switch 7 - 7.5 IRE - 0.0 IRE

The USA and countries using NTSC with 7.5 setup should set switch 7 to OFF. If you're working in countries not using 7.5 setup, for example Japan, set switch 7 to ON. This setting only affects composite or S-Video outputs.

### Switch 6 - SMPTE Levels - Betacam Levels

This setting selects between SMPTE or Betacam video levels. Set switch 6 to OFF for SMPTE levels, or to ON for Betacam levels. SMPTE levels are more common and even Betacam SP decks can use SMPTE levels so only switch this to Betacam if you are sure that Betacam levels are being used.

### Switch 5 - Component, Composite or S-Video

Set switch 5 to OFF to select analog component video input, or to ON for composite video and S-Video analog inputs.

	OFF	ON
8	ANALOG AUDIO	AES/EBU AUDIO
7	7.5 IRE	0.0 IRE
6	SMPTE LEVELS	BETACAM LEVELS
5	COMPONENT	COMPOSITE or S-VIDEO
4	COMPOSITE	S-VIDEO
3		
2		
1	PROCESSING OFF	PROCESSING ON

The switch legend on the base of your converter gives you all the information you need to change conversion settings.

### Switch 4 - Composite - S-Video

Set switch 4 to OFF to select composite video input, or to ON for S-Video input.

### Switch 1 - Processing Off - Processing On

This switch is not used.

### Mini Switch Settings Example

Experiment with the switches by setting your Blackmagic Mini Converter to Component and Analog Audio input by setting switches 8 and 5 to the OFF position.

## Blackmagic Converters Setup Settings

The Converters Setup utility can be used to change settings and update your Mini Converter's software. You can access these settings by moving between the 'video,' 'audio,' and 'about' tabs.

The 'about' tab is detailed in the 'changing settings' section in this manual.

The 'video' tab for Mini Converter Analog to SDI contains the following settings.

### Input Levels menu

This lets you set the luminance and chroma levels, and the B-Y and R-Y component levels independently.

The 'audio' tab for Mini Converter Analog to SDI contains the following settings.

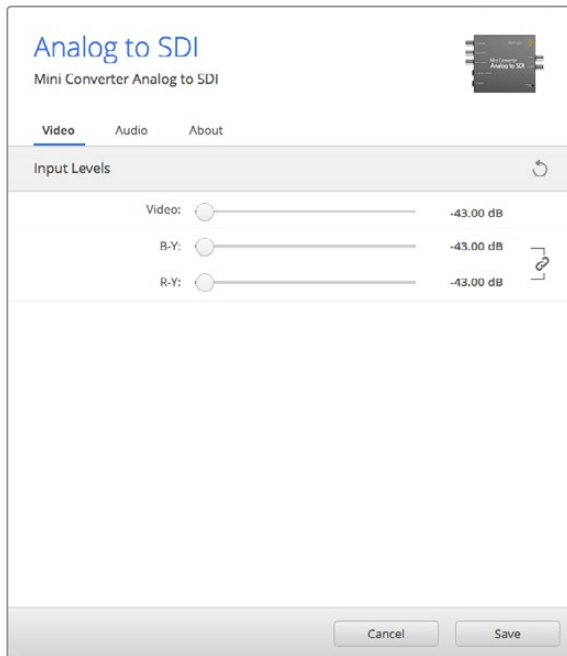

Use the 'video' tab in Converters Setup to adjust video levels.

### Input Levels menu

This menu allows you to adjust the gain on the audio input. You can adjust audio levels independently per channel, or together by clicking the 'link' icon next to their sliders. To reset all audio levels back to 0 dB click the 'reset' button at the top of the 'input levels' menu.

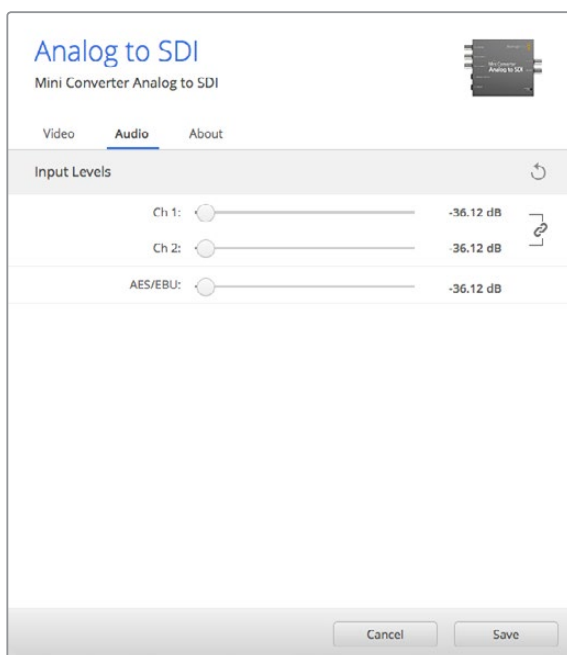

Use the 'audio' tab in Converters Setup to adjust analog audio levels.

## Mini Converter Analog to SDI Block Diagram

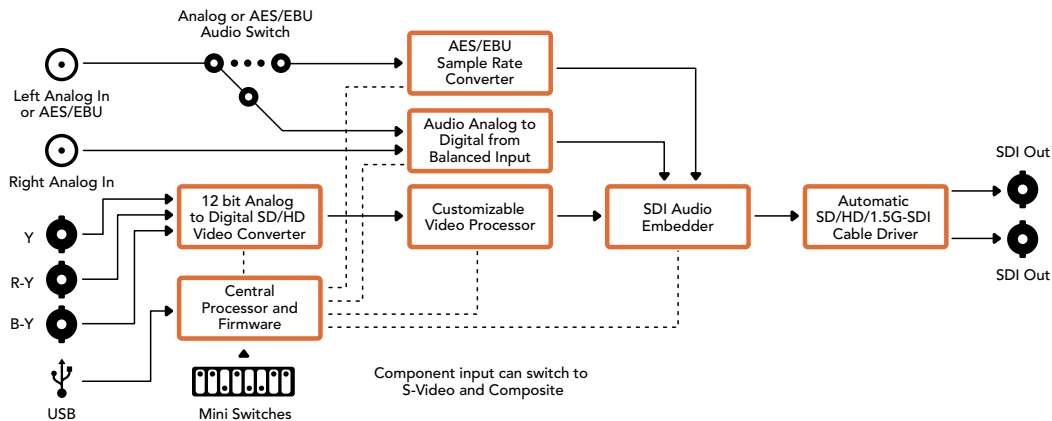

## Mini Converter SDI to Audio

Your Mini Converter SDI to Audio can de-embed 4 channels of audio from any SDI video connection and output to 4 channels of analog audio or 8 channels of AES/EBU digital. Output to audio equipment such as audio mixers, analog decks and reference monitors. Additional SDI audio channels can be de-embedded by daisy chaining another Mini Converter SDI to Audio to your converter's SDI output.

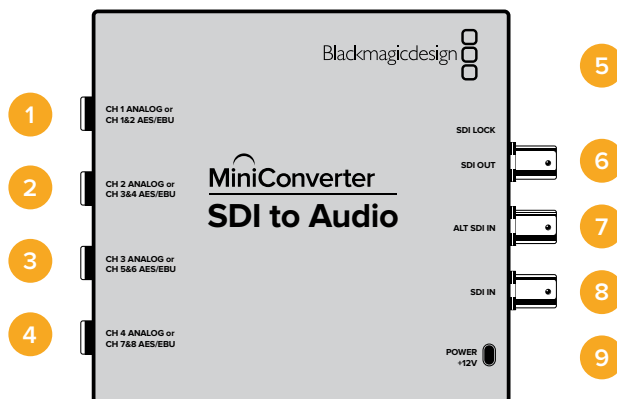

## Connectors

- 1 CH 1 ANALOG or CH 1 & 2 AES/EBU**  
 Balanced analog audio channel 1, or AES/EBU digital audio channels 1 and 2 output 1/4" jack connector.
- 2 CH 2 Analog or CH 3 & 4 AES/EBU**  
 Balanced analog audio channel 2, or AES/EBU digital audio channels 3 and 4 output 1/4" jack connector.
- 3 CH 3 Analog or CH 5 & 6 AES/EBU**  
 Balanced analog audio channel 3, or AES/EBU digital audio channels 5 and 6 output 1/4" jack connector.
- 4 CH 4 Analog or CH 7 & 8 AES/EBU**  
 Balanced analog audio channel 4, or AES/EBU digital audio channels 7 and 8 output 1/4" jack connector.

## 5 MINI-B USB PORT

Connects to the Converters Setup software via your Mac OS X or Windows computer. The Mini Converter's internal software is also updated using the USB port.

## 6 SDI OUT

Loop through SDI video output BNC connector.

## 7 ALT SDI IN

Redundant SDI input provided as an optional back up. When using both the SDI IN and ALT SDI IN, the ALT SDI IN will take over should the SDI IN signal fail. The SDI LOCK LED will flash indicating that the converter has switched to the ALT SDI IN.

## 8 SDI IN

Primary SDI input.

## 9 POWER +12V

12 volt power supply input.

## Switches

Mini Converter SDI to Audio's switches provide the following settings:

### Switch 8 - Analog Audio, AES/EBU Audio

Set switch 8 to OFF to select balanced analog audio, or to ON for digital AES/EBU audio output.

### Switch 6 - Audio Group Bit 1

Switches 6 and 5 are grouped together to provide four ON/OFF combinations. This allows up to 4 quadruplets of analog audio channels, or 2 sets of 8 AES/EBU audio channels, to be de-embedded from your SDI input.

### Switch 5 - Audio Group Bit 0

See switch 6 description.

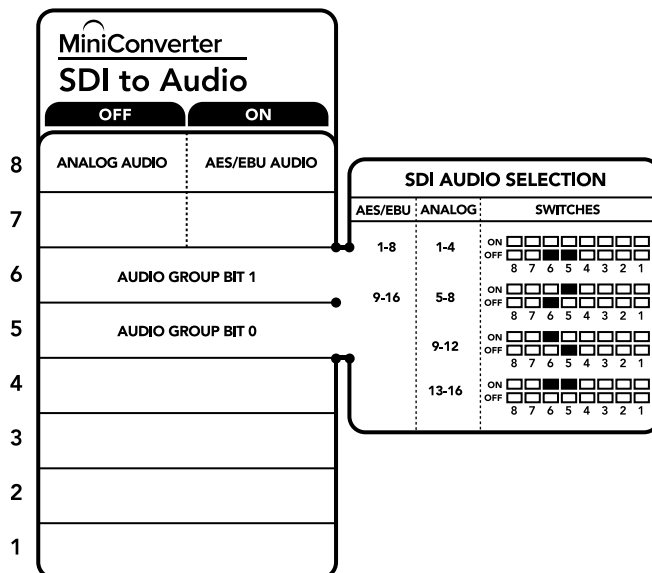

The switch legend on the base of your converter gives you all the information you need to change conversion settings.

## Mini Switch Settings Example

Try experimenting with the switches. Select analog audio channels 1 to 4 by setting switches 8, 6 and 5 to the OFF position.

## Audio Selection Tables

Analog Audio Channels	Switch 6	Switch 5	Switch Diagram
1 to 4	OFF	OFF	
5 to 8	OFF	ON	
9 to 12	ON	OFF	
13 to 16	ON	ON	

AES/EBU Channels	Switch 6	Switch 5	Switch Diagram
1 to 8	OFF	OFF	
9 to 16	OFF	ON	

## Blackmagic Converters Setup Settings

The Converters Setup utility can be used to change settings and update your Mini Converter's software. You can access these settings by moving between the 'audio,' and 'about' tabs.

The 'about' tab is detailed in the 'changing settings' section in this manual.

The 'audio' tab for Mini Converter SDI to Audio contains the following settings.

### Output Levels menu

This menu allows you to adjust the gain on the audio output. You can adjust audio levels independently per channel, or together as channel pairs by clicking the 'link' icon next to their sliders. To reset all audio levels back to 0 dB click the 'reset' button at the top of the 'output levels' menu.

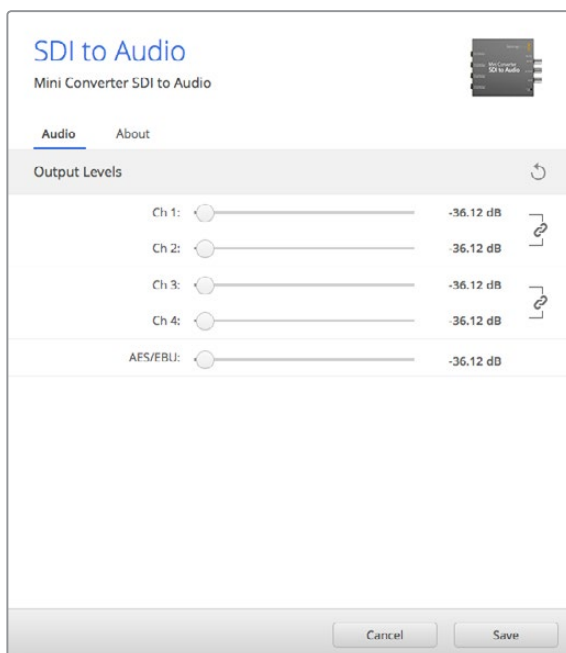

Use the 'audio' tab in Converters Setup to adjust audio levels.

## Mini Converter SDI to Audio Block Diagram

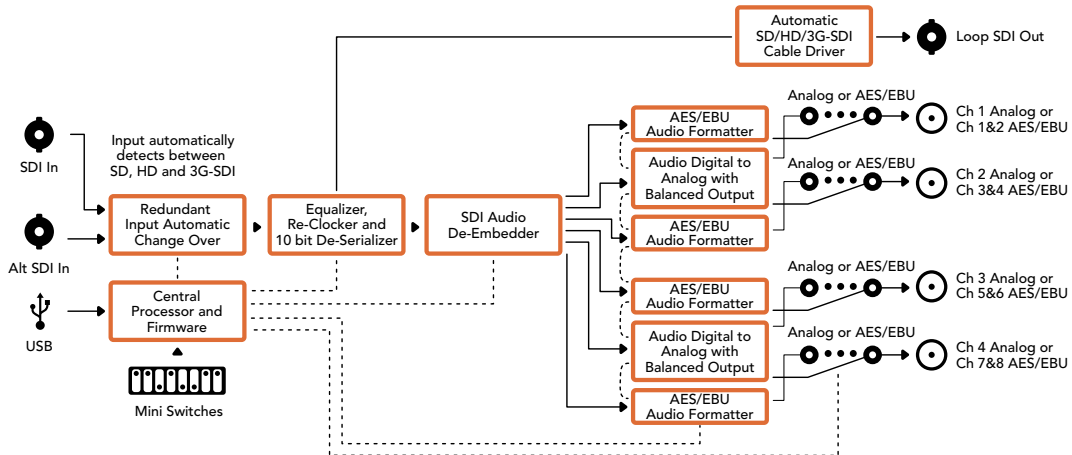

## Mini Converter SDI to Audio 4K

With Mini Converter SDI to Audio 4K you can de-embed 4 channels of audio from any SDI video connection and output to 4 channels of analog audio or 8 channels of AES/EBU digital. Output to audio equipment such as audio mixers, analog decks and reference monitors. Additional SDI audio channels can be de-embedded by daisy chaining another Mini Converter SDI to Audio 4K to your converter's SDI output.

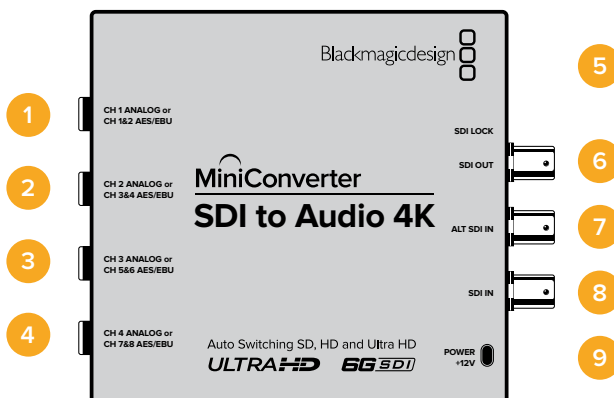

## Connectors

- 1 CH 1 ANALOG or CH 1 & 2 AES/EBU**  
Balanced analog audio channel 1, or AES/EBU digital audio channels 1 and 2 output 1/4" jack connector.
- 2 CH 2 Analog or CH 3 & 4 AES/EBU**  
Balanced analog audio channel 2, or AES/EBU digital audio channels 3 and 4 output 1/4" jack connector.
- 3 CH 3 Analog or CH 5 & 6 AES/EBU**  
Balanced analog audio channel 3, or AES/EBU digital audio channels 5 and 6 output 1/4" jack connector.
- 4 CH 4 Analog or CH 7 & 8 AES/EBU**  
Balanced analog audio channel 4, or AES/EBU digital audio channels 7 and 8 output 1/4" jack connector.



## 5 MINI-B USB PORT

Connects to the Converters Setup software via your Mac OS X or Windows computer. The Mini Converter's internal software is also updated using the USB port.

## 6 SDI OUT

Loop through SDI video output BNC connector.

## 7 ALT SDI IN

Redundant SDI input provided as an optional back up. When using both the SDI IN and ALT SDI IN, the ALT SDI IN will take over should the SDI IN signal fail. The SDI LOCK LED will flash indicating that the converter has switched to the ALT SDI IN.

## 8 SDI IN

Primary SDI input.

## 9 POWER +12V

12 volt power supply input.

## Switches

Mini Converter SDI to Audio 4K switches provide the following settings:

### Switch 8 - Analog Audio, AES/EBU Audio

Set switch 8 to OFF to select balanced analog audio, or to ON for digital AES/EBU audio output.

### Switch 6 - Audio Group Bit 1

Switches 6 and 5 are grouped together to provide four ON/OFF combinations. This allows up to 4 quadruplets of analog audio channels, or 2 sets of 8 AES/EBU audio channels, to be de-embedded from your SDI input.

### Switch 5 - Audio Group Bit 0

See switch 6 description.

## Mini Switch Settings Example

Try experimenting with the switches. Select analog audio channels 1 to 4 by setting switches 8, 6 and 5 to the OFF position.

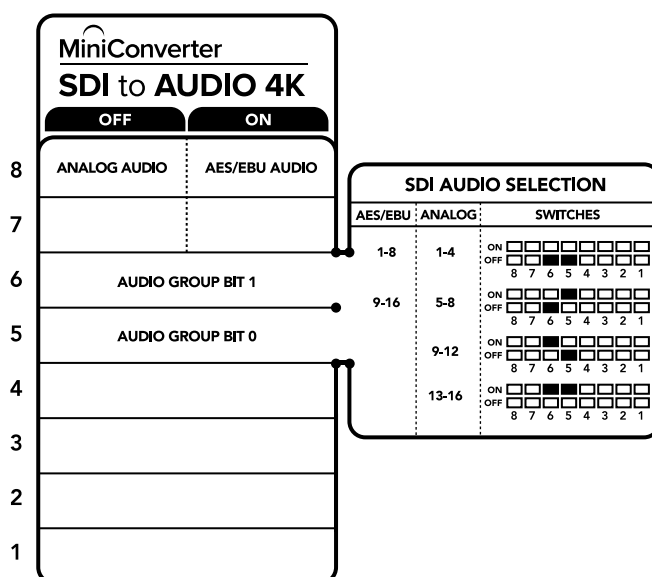

The switch legend on the base of your converter gives you all the information you need to change conversion settings.

## Audio Selection Tables

Analog Audio Channels	Switch 6	Switch 5	Switch Diagram
1 to 4	OFF	OFF	<pre> ON  [ ] [ ] [ ] [ ] [ ] [ ] [ ] [ ] OFF [ ] [ ] [ ] [ ] [ ] [ ] [ ] [ ]       8 7 6 5 4 3 2 1           </pre>
5 to 8	OFF	ON	<pre> ON  [ ] [ ] [ ] [ ] [ ] [ ] [ ] [ ] OFF [ ] [ ] [ ] [ ] [ ] [ ] [ ] [ ]       8 7 6 5 4 3 2 1           </pre>
9 to 12	ON	OFF	<pre> ON  [ ] [ ] [ ] [ ] [ ] [ ] [ ] [ ] OFF [ ] [ ] [ ] [ ] [ ] [ ] [ ] [ ]       8 7 6 5 4 3 2 1           </pre>
13 to 16	ON	ON	<pre> ON  [ ] [ ] [ ] [ ] [ ] [ ] [ ] [ ] OFF [ ] [ ] [ ] [ ] [ ] [ ] [ ] [ ]       8 7 6 5 4 3 2 1           </pre>

AES/EBU Channels	Switch 6	Switch 5	Switch Diagram
1 to 8	OFF	OFF	<pre> ON  [ ] [ ] [ ] [ ] [ ] [ ] [ ] [ ] OFF [ ] [ ] [ ] [ ] [ ] [ ] [ ] [ ]       8 7 6 5 4 3 2 1           </pre>
9 to 16	OFF	ON	<pre> ON  [ ] [ ] [ ] [ ] [ ] [ ] [ ] [ ] OFF [ ] [ ] [ ] [ ] [ ] [ ] [ ] [ ]       8 7 6 5 4 3 2 1           </pre>

## Blackmagic Converters Setup Settings

The Converters Setup utility can be used to change settings and update your Mini Converter's software. You can access these settings by moving between the 'audio,' and 'about' tabs.

The 'about' tab is detailed in the 'changing settings' section in this manual.

The 'audio' tab for Mini Converter SDI to Audio 4K contains the following settings.

### Output Levels menu

This menu allows you to adjust the gain on the audio output. You can adjust audio levels independently per channel, or together as channel pairs by clicking the 'link' icon next to their sliders. To reset all audio levels back to 0 dB click the 'reset' button at the top of the 'output levels' menu.

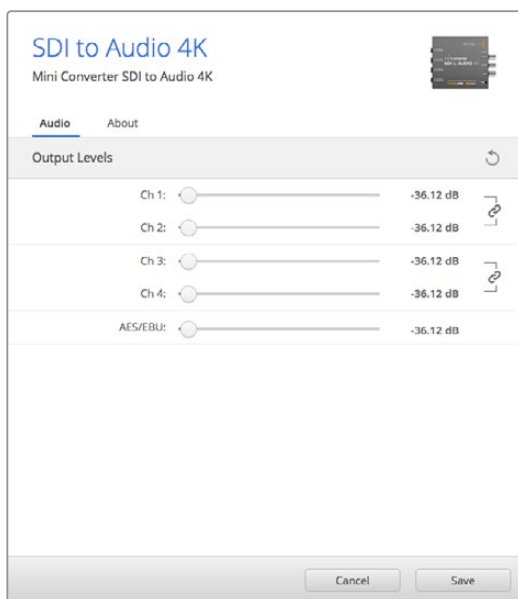

Use the 'audio' tab in Converters Setup to adjust analog audio levels.

## Mini Converter SDI to Audio 4K Block Diagram

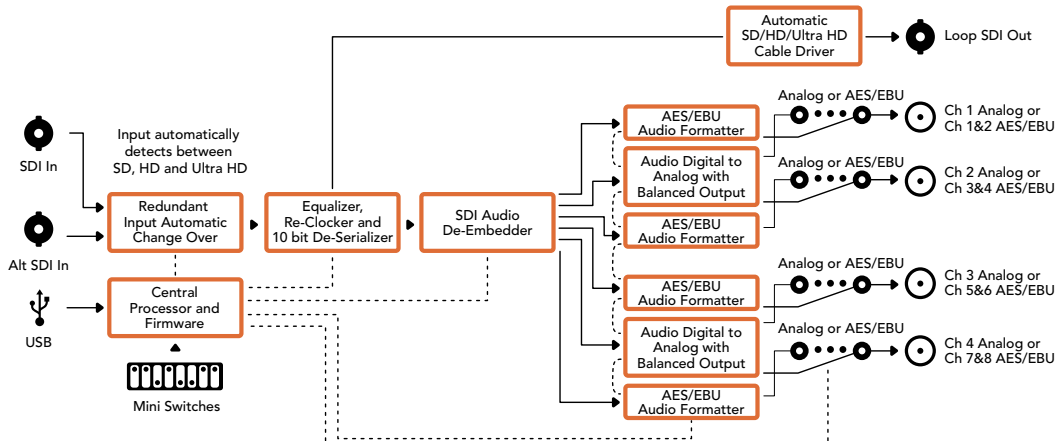

## Mini Converter Audio to SDI

Your Mini Converter Audio to SDI can embed four channels of analog audio, or eight channels of AES/EBU digital audio into any SDI video connection. You can use this Mini Converter to embed audio from equipment, such as audio mixers and analog decks, into SDI video connections for use with SDI routers and decks. Additional SDI audio channels can be embedded by daisy chaining another Mini Converter Audio to SDI to your converter's SDI output.



## Connectors

- 1 CH 1 Analog or CH 1 & 2 AES/EBU**  
Balanced analog audio channel 1, or AES/EBU digital audio channels 1 and 2 input 1/4" jack connector.
- 2 CH 2 Analog or CH 3 & 4 AES/EBU**  
Balanced analog audio channel 2, or AES/EBU digital audio channels 3 and 4 input 1/4" jack connector.
- 3 CH 3 Analog or CH 5 & 6 AES/EBU**  
Balanced analog audio channel 3, or AES/EBU digital audio channels 5 and 6 input 1/4" jack connector.
- 4 CH 4 Analog or CH 7 & 8 AES/EBU**  
Balanced analog audio channel 4, or AES/EBU digital audio channels 7 and 8 input 1/4" jack connector.
- 5 Mini-B USB PORT**  
Connects to the Converters Setup software via your Mac OS X or Windows computer. The Mini Converter's internal software is also updated using the USB port.

**6 SDI OUT**

Loop through SDI video output BNC connector.

**7 ALT SDI IN**

Redundant SDI input provided as an optional back up. When using both the SDI IN and ALT SDI IN, the ALT SDI IN will take over should the SDI IN signal fail. The SDI LOCK LED will flash indicating that the converter has switched to the ALT SDI IN.

**8 SDI IN**

Primary SDI input.

**9 POWER +12V**

12 volt power supply input.

## Switches

Mini Converter Audio to SDI's switches provide the following settings:

**Switch 8 - Analog Audio, AES/EBU Audio**

Set switch 8 to OFF to select balanced analog audio, or to ON for digital AES/EBU audio input.

**Switch 7 - Sample Rate Conversion, No Sample Rate Conversion**

Set switch 7 to OFF to enable sample rate conversion, or ON to disable sample rate conversion. This switch should almost always be set to OFF to ensure audio is embedded at the correct sample rate for television.

When switch 7 is set to OFF this setting converts the sample rate of your analog or AES/EBU audio and embeds audio into the SDI output at a sample rate of 48 kHz. When switch 7 is set to ON, sample rate conversion is disabled and audio is output at the original sample rate of your input audio.

**Switch 6 - Audio Group Bit 1**

Switches 6 and 5 are grouped together to provide four ON/OFF combinations. Having four different combinations allows up to four analog audio channels, or eight AES/EBU audio channels to be embedded in your SDI output.

**Switch 5 - Audio Group Bit 0**

See switch 6 description.

### Audio Selection Table

Analog Audio Channels	Switch 6	Switch 5	Switch Diagram
1 to 4	OFF	OFF	ON <input type="checkbox"/> <input type="checkbox"/> <input type="checkbox"/> <input type="checkbox"/> <input type="checkbox"/> <input type="checkbox"/> <input type="checkbox"/> <input type="checkbox"/> OFF <input type="checkbox"/> <input type="checkbox"/> <input type="checkbox"/> <input type="checkbox"/> <input type="checkbox"/> <input type="checkbox"/> <input type="checkbox"/> <input type="checkbox"/> 8 7 6 5 4 3 2 1
5 to 8	OFF	ON	ON <input type="checkbox"/> <input type="checkbox"/> <input type="checkbox"/> <input checked="" type="checkbox"/> <input type="checkbox"/> <input type="checkbox"/> <input type="checkbox"/> <input type="checkbox"/> OFF <input type="checkbox"/> <input type="checkbox"/> <input type="checkbox"/> <input type="checkbox"/> <input type="checkbox"/> <input type="checkbox"/> <input type="checkbox"/> <input type="checkbox"/> 8 7 6 5 4 3 2 1
9 to 12	ON	OFF	ON <input type="checkbox"/> <input type="checkbox"/> <input checked="" type="checkbox"/> <input type="checkbox"/> <input type="checkbox"/> <input type="checkbox"/> <input type="checkbox"/> <input type="checkbox"/> OFF <input type="checkbox"/> <input type="checkbox"/> <input type="checkbox"/> <input type="checkbox"/> <input type="checkbox"/> <input type="checkbox"/> <input type="checkbox"/> <input type="checkbox"/> 8 7 6 5 4 3 2 1
13 to 16	ON	ON	ON <input type="checkbox"/> <input checked="" type="checkbox"/> <input checked="" type="checkbox"/> <input type="checkbox"/> <input type="checkbox"/> <input type="checkbox"/> <input type="checkbox"/> <input type="checkbox"/> OFF <input type="checkbox"/> <input type="checkbox"/> <input type="checkbox"/> <input type="checkbox"/> <input type="checkbox"/> <input type="checkbox"/> <input type="checkbox"/> <input type="checkbox"/> 8 7 6 5 4 3 2 1
AES/EBU Channels	Switch 6	Switch 5	Switch Diagram
1 to 8	OFF	OFF	ON <input type="checkbox"/> <input type="checkbox"/> <input type="checkbox"/> <input type="checkbox"/> <input type="checkbox"/> <input type="checkbox"/> <input type="checkbox"/> <input type="checkbox"/> OFF <input type="checkbox"/> <input type="checkbox"/> <input type="checkbox"/> <input type="checkbox"/> <input type="checkbox"/> <input type="checkbox"/> <input type="checkbox"/> <input type="checkbox"/> 8 7 6 5 4 3 2 1
9 to 16	OFF	ON	ON <input type="checkbox"/> <input type="checkbox"/> <input checked="" type="checkbox"/> <input type="checkbox"/> <input type="checkbox"/> <input type="checkbox"/> <input type="checkbox"/> <input type="checkbox"/> OFF <input type="checkbox"/> <input type="checkbox"/> <input type="checkbox"/> <input type="checkbox"/> <input type="checkbox"/> <input type="checkbox"/> <input type="checkbox"/> <input type="checkbox"/> 8 7 6 5 4 3 2 1

## Embedding or Disabling Channels

Once you have selected your audio channels, use switches 4, 3, 2 and 1 to select which channels to embed or disable. The disable setting lets you avoid overwriting audio channels you wish to keep in the SDI signal.

For example, you can disable analog audio channel 1 or AES/EBU channels 1 and 2 by setting switch 1 to the ON position. Alternatively, you can embed the audio channels by setting switch 1 to the OFF position.

### Audio Channel De-Embed or Disable Settings

Switch	Setting	Audio Channels
4	ON	Disable analog CH 4, AES/EBU CH 7 and 8
	OFF	Embed analog CH 4, AES/EBU CH 7 and 8
3	ON	Disable analog CH 3, AES/EBU CH 5 and 6
	OFF	Embed analog CH 3, AES/EBU CH 5 and 6
2	ON	Disable analog CH 2, AES/EBU CH 3 and 4
	OFF	Embed analog CH 2, AES/EBU CH 3 and 4
1	ON	Disable analog CH 1, AES/EBU CH 1 and 2
	OFF	Embed analog CH 1, AES/EBU CH 1 and 2

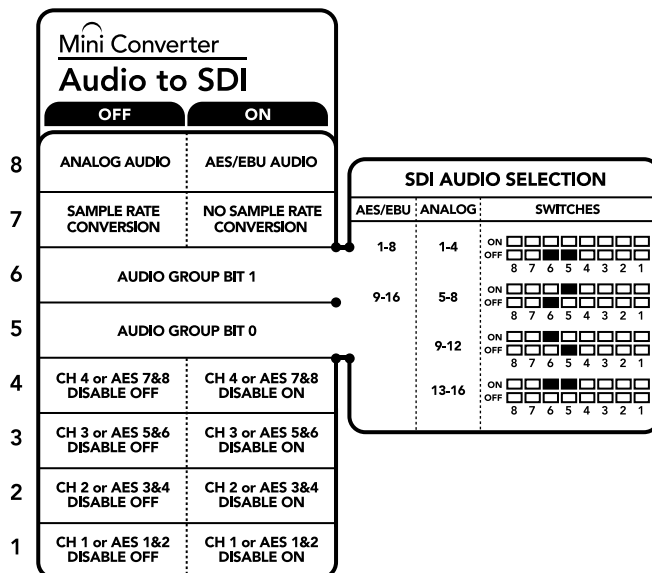

The switch legend on the base of your converter gives you all the information you need to change conversion settings.

### Mini Switch Settings Example:

Try experimenting with the switches. Select analog audio channels 1 to 4 by setting switches 8, 6 and 5 to the OFF position.

## Blackmagic Converters Setup Settings

The Converters Setup utility can be used to change settings and update your Mini Converter's software. You can access these settings by moving between the 'audio,' and 'about' tabs.

The 'about' tab is detailed in the 'changing settings' section in this manual.

The 'audio' tab for Mini Converter Audio to SDI contains the following settings.

### Input Levels menu

This menu allows you to adjust the gain on the audio input. You can adjust audio levels independently per channel, or together as channel pairs by clicking the 'link' icon next to their sliders. To reset all audio levels back to 0 dB click the 'reset' button at the top of the 'output levels' menu.

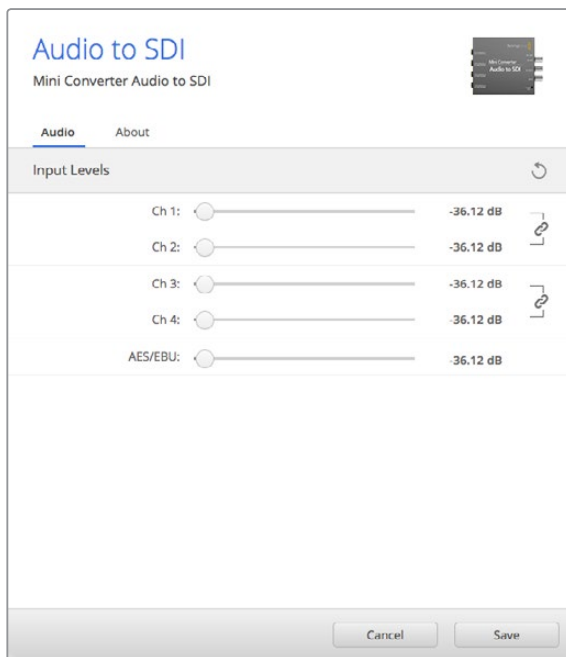

Use the 'audio' tab in Converters Setup to adjust analog audio levels.

### Mini Converter Audio to SDI Block Diagram

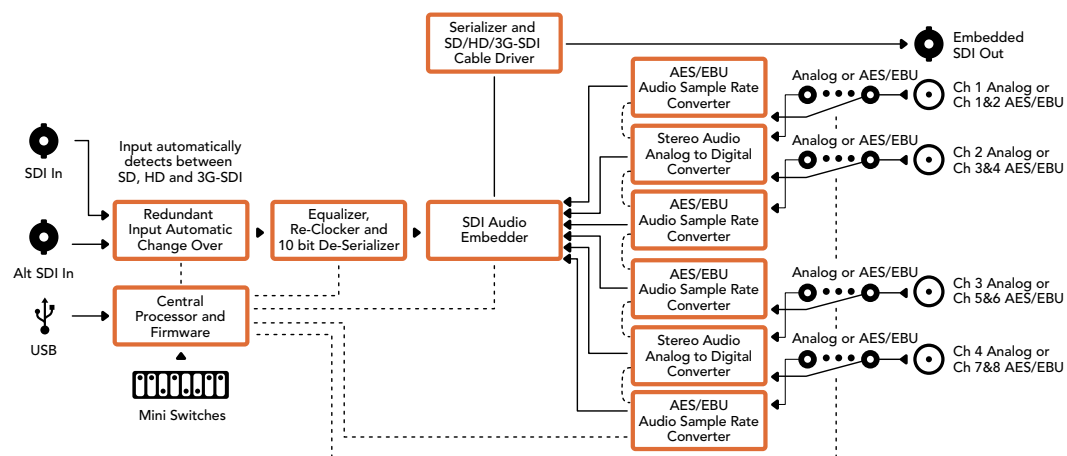

## Mini Converter Audio to SDI 4K

Your Mini Converter Audio to SDI 4K can embed four channels of analog audio, or eight channels of AES/EBU digital audio into any SDI video connection. You can use this Mini Converter to embed audio from equipment, such as audio mixers and analog decks, into SDI video connections for use with SDI routers and decks. Additional SDI audio channels can be embedded by daisy chaining another Mini Converter Audio to SDI 4K to your converter's SDI output.



## Connectors

- 1 CH 1 Analog or CH 1 & 2 AES/EBU**  
Balanced analog audio channel 1, or AES/EBU digital audio channels 1 and 2 input 1/4" jack connector.
- 2 CH 2 Analog or CH 3 & 4 AES/EBU**  
Balanced analog audio channel 2, or AES/EBU digital audio channels 3 and 4 input 1/4" jack connector.
- 3 CH 3 Analog or CH 5 & 6 AES/EBU**  
Balanced analog audio channel 3, or AES/EBU digital audio channels 5 and 6 input 1/4" jack connector.
- 4 CH 4 Analog or CH 7 & 8 AES/EBU**  
Balanced analog audio channel 4, or AES/EBU digital audio channels 7 and 8 input 1/4" jack connector.
- 5 Mini-B USB PORT**  
Connects to the Converters Setup software via your Mac OS X or Windows computer. The Mini Converter's internal software is also updated using the USB port.
- 6 SDI OUT**  
Loop through SDI video output on a BNC connector.
- 7 ALT SDI IN**  
Redundant SDI input provided as an optional back up. When using both the SDI IN and ALT SDI IN, the ALT SDI IN will take over should the SDI IN signal fail. The SDI LOCK LED will flash indicating that the converter has switched to the ALT SDI IN.
- 8 SDI IN**  
Primary SDI input.
- 9 POWER +12V**  
12 volt power supply input.

## Switches

Mini Converter Audio to SDI 4K switches provide the following settings:

### Switch 8 - Analog Audio, AES/EBU Audio

Set switch 8 to OFF to select balanced analog audio, or to ON for digital AES/EBU audio input.

### Switch 7 - Sample Rate Conversion, No Sample Rate Conversion

Set switch 7 to OFF to enable sample rate conversion, or ON to disable sample rate conversion. This switch should almost always be set to OFF to ensure audio is embedded at the correct sample rate for television.

When switch 7 is set to OFF this setting converts the sample rate of your analog or AES/EBU audio and embeds audio into the SDI output at a sample rate of 48 kHz. When switch 7 is set to ON, sample rate conversion is disabled and audio is output at the original sample rate of your input audio.

### Switch 6 - Audio Group Bit 1

Switches 6 and 5 are grouped together to provide four ON/OFF combinations. Having four different combinations allows up to four analog audio channels, or eight AES/EBU audio channels to be embedded in your SDI output.

### Switch 5 - Audio Group Bit 0

See switch 6 description.

### Audio Selection Table

Analog Audio Channels	Switch 6	Switch 5	Switch Diagram
1 to 4	OFF	OFF	ON OFF
5 to 8	OFF	ON	ON OFF
9 to 12	ON	OFF	ON OFF
13 to 16	ON	ON	ON OFF
AES/EBU Channels	Switch 6	Switch 5	Switch Diagram
1 to 8	OFF	OFF	ON OFF
9 to 16	OFF	ON	ON OFF

## Embedding or Disabling Channels

Once you have selected your audio channels, use switches 4, 3, 2 and 1 to select which channels to embed or disable. The disable setting lets you avoid overwriting audio channels you wish to keep in the SDI signal.

For example, you can disable analog audio channel 1 or AES/EBU channels 1 and 2 by setting switch 1 to the ON position. Alternatively, you can embed the audio channels by setting switch 1 to the OFF position.



## Audio Channel De-Embed or Disable Settings

Switch	Setting	Audio Channels
4	ON	Disable analog CH 4, AES/EBU CH 7 and 8
	OFF	Embed analog CH 4, AES/EBU CH 7 and 8
3	ON	Disable analog CH 3, AES/EBU CH 5 and 6
	OFF	Embed analog CH 3, AES/EBU CH 5 and 6
2	ON	Disable analog CH 2, AES/EBU CH 3 and 4
	OFF	Embed analog CH 2, AES/EBU CH 3 and 4
1	ON	Disable analog CH 1, AES/EBU CH 1 and 2
	OFF	Embed analog CH 1, AES/EBU CH 1 and 2

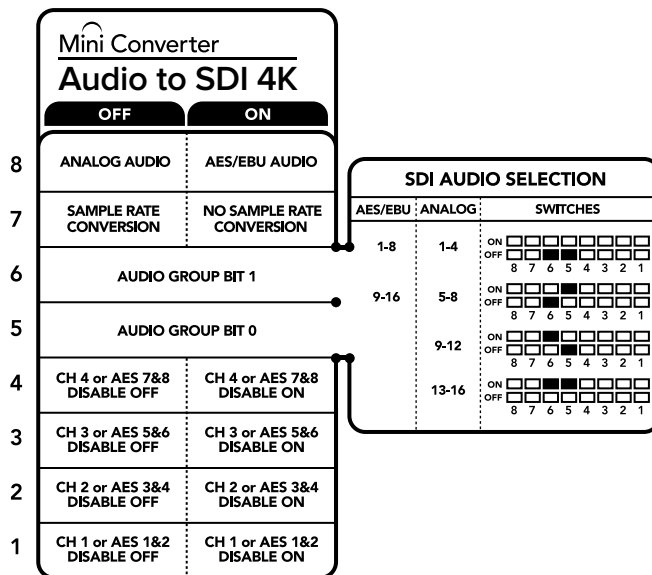

The switch legend on the base of your converter gives you all the information you need to change conversion settings.

## Mini Switch Settings Example

Try experimenting with the switches. Select analog audio channels 1 to 4 by setting switches 8, 6 and 5 to the OFF position.

## Blackmagic Converters Setup Settings

The Converters Setup utility can be used to change settings and update your Mini Converter's software. You can access these settings by moving between the 'audio,' and 'about' tabs.

The 'about' tab is detailed in the 'changing settings' section in this manual.

The 'audio' tab for Mini Converter Audio to SDI 4K contains the following settings.

## Input Levels menu

This menu allows you to adjust the gain on the audio input. You can adjust audio levels independently per channel, or together as channel pairs by clicking the 'link' icon next to their sliders. To reset all audio levels back to 0 dB click the 'reset' button at the top of the 'output levels' menu.

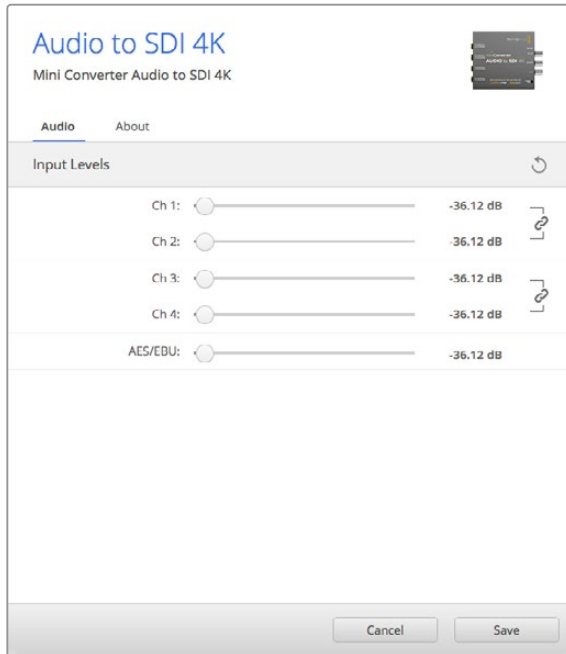

Use the 'audio' tab in Converters Setup to adjust analog audio levels.

## Mini Converter Audio to SDI 4K Block Diagram

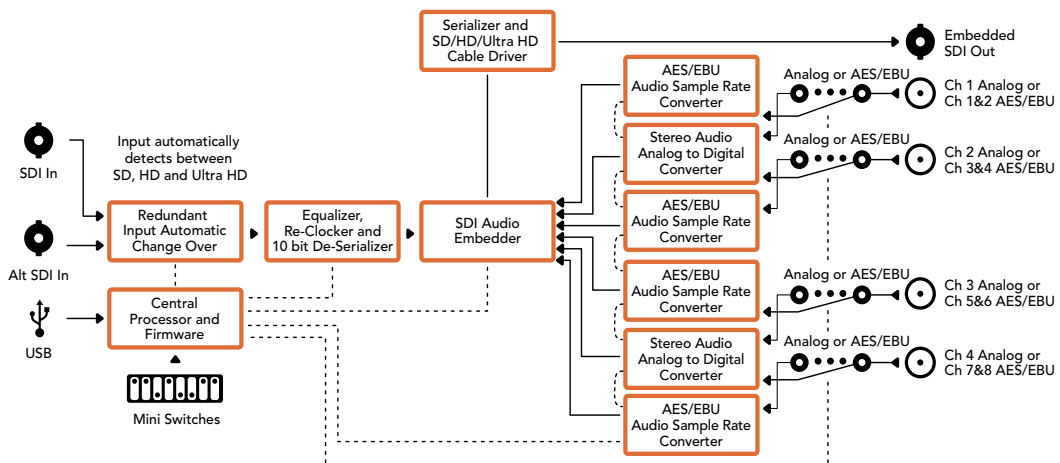

## Mini Converter Optical Fiber

With Mini Converter Optical Fiber you can convert SDI to Optical Fiber and Optical Fiber to SDI simultaneously. Mini Converter Optical Fiber automatically switches between SD/HD/3G-SDI video standards and both directions are completely independent. Use this converter if you need to send and receive SDI signals over longer distances than traditional SDI cables will support. SD video can be sent up to 45 km or 147000 feet using optical fiber, compared to just 300 feet with copper SDI cables. 3G-SDI can be sent up to 25 km away!

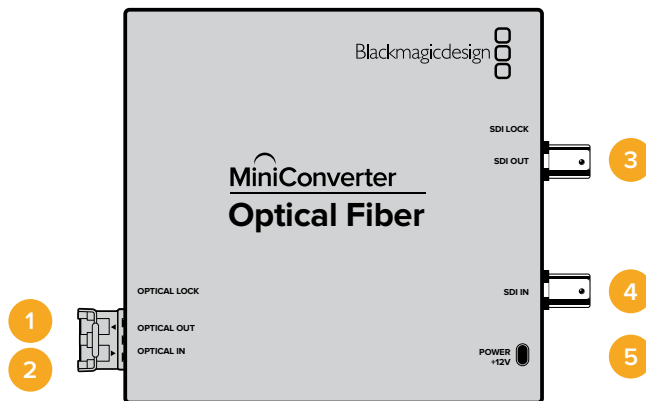

## Connectors

- 1 Optical Out**  
Optical fiber output supports a single mode optical fiber cable with LC connector.
- 2 Optical In**  
Optical fiber input supports a single mode optical fiber cable with LC connector.
- 3 3G-SDI Out**  
SDI video output on a BNC connector for connection to traditional SDI equipment.
- 4 3G-SDI In**  
SDI input on a BNC connector for connection to traditional SDI equipment.
- 5 Power +12V**  
12 volt power supply input.

## Mini Converter Optical Fiber Block Diagram

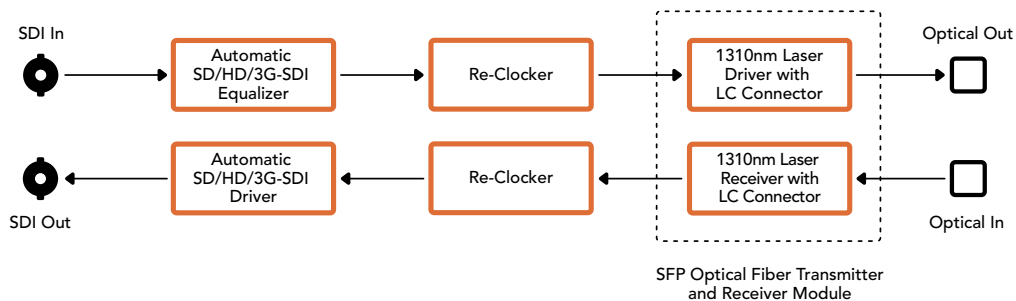

## Mini Converter Optical Fiber 4K

Convert SD/HD and single link 6G-SDI to Optical Fiber and Optical Fiber to SD/HD and single link 6G-SDI simultaneously. Mini Converter Optical Fiber 4K automatically switches between SD/HD/3G/6G-SDI video standards and both directions are completely independent. Use this converter if you need to send and receive SDI signals over longer distances than traditional SDI cables will support. SD video can be sent up to 45 km or 147000 feet using optical fiber, compared to just 300 feet with copper SDI cables. 6G-SDI can be sent up to 12 km away!

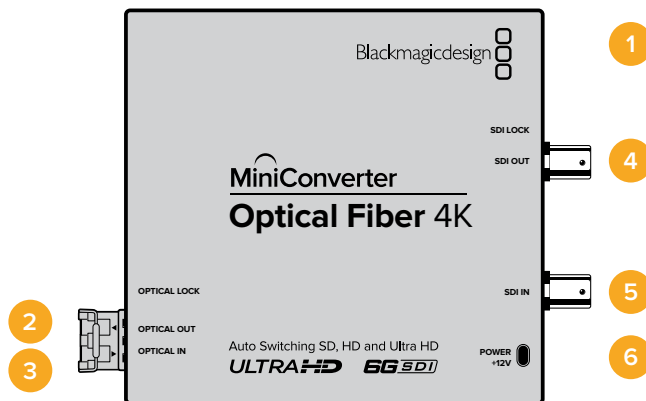

## Connectors

- 1 Mini-B USB Port**  
The Mini Converter's internal software is updated using the USB port.
- 2 Optical Out**  
Optical fiber output supports a single mode optical fiber cable with LC connector.
- 3 Optical In**  
Optical fiber input supports a single mode optical fiber cable with LC connector.
- 4 SDI Out**  
SDI video output on a BNC connector for connection to traditional SDI equipment.
- 5 SDI In**  
SDI input on a BNC connector for connection to traditional SDI equipment.
- 6 Power +12V**  
12 volt power supply input.

## Mini Converter Optical Fiber 4K Block Diagram

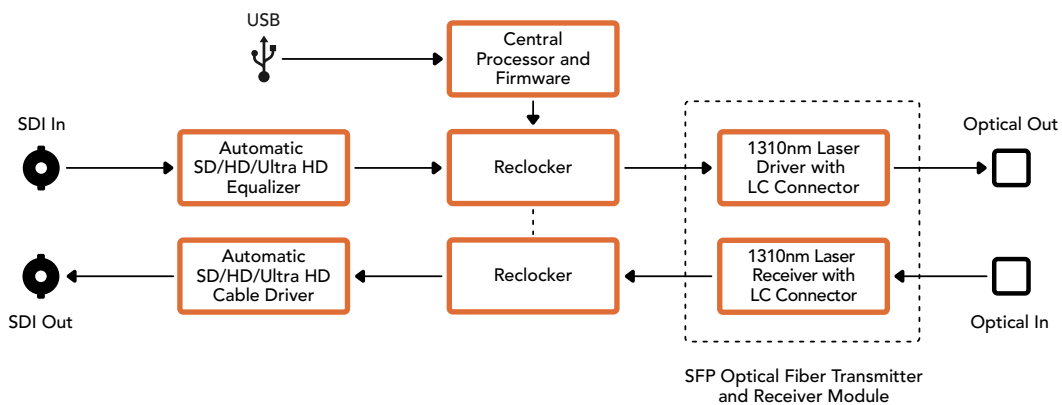

## Mini Converter Optical Fiber 12G

This converter converts SD and HD video up to 12G-SDI to optical fiber and the other way around simultaneously.

The socket for the SFP type optical fiber module can be fitted with a compatible SFP optical fiber module that supports up to 3G, 6G or 12G-SDI video.

Your converter automatically detects the video input format and sets the output format to match. Both directions are completely independent.

This converter is helpful if you need to send and receive SDI signals over longer distances than traditional SDI cables will support. For example, SD video can be sent up to 45 km or 147,000 feet using optical fiber, compared to just 300 feet with copper SDI cables. 12G-SDI can be sent up to 6 km away!

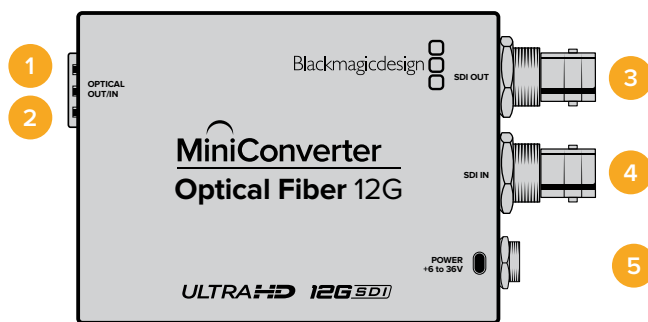

## Connectors

- 1 Optical Out**  
Optical fiber output supports a single mode optical fiber cable with LC connector.
- 2 Optical In**  
Optical fiber input supports a single mode optical fiber cable with LC connector.
- 3 SDI Out**  
SDI video output on a BNC connector for connection to SDI equipment.
- 4 SDI In**  
SDI input on a BNC connector for connection to SDI equipment.
- 5 Power +6 to 36V**  
6-36 volt power supply input. The support screw can be secured to the unit's power connector to prevent accidental disconnection.

## Mini Converter Optical Fiber 12G Block Diagram

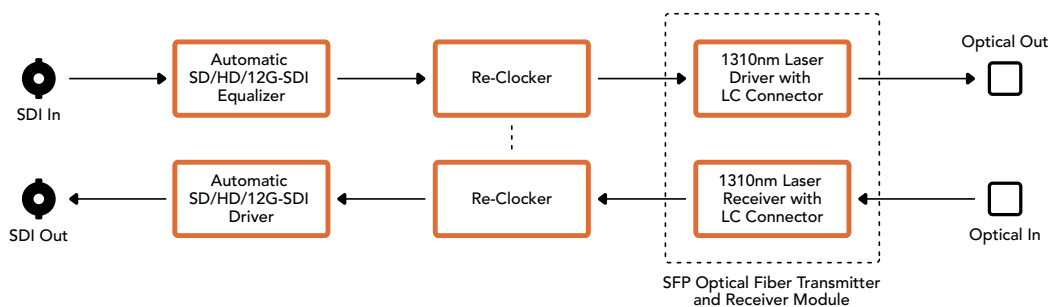

## Mini Converter Quad SDI to HDMI 4K

Your Mini Converter Quad SDI to HDMI 4K can connect single link, dual link and quad link SDI Ultra HD to the latest Ultra HD projectors and televisions that support Ultra HD over a single HDMI link. You can also convert any of the following inputs to HDMI:

- SD SDI
- HD-SDI
- Singlelink 3G-SDI
- Singlelink 6G-SDI
- Duallink HD-SDI
- Dual link 3G-SDI Ultra HD
- Quad link HD-SDI Ultra HD

If the HDMI output detects an HD monitor or HDTV, the output signal is automatically downconverted. Only use inputs 1 and 2 with a valid dual link signal.

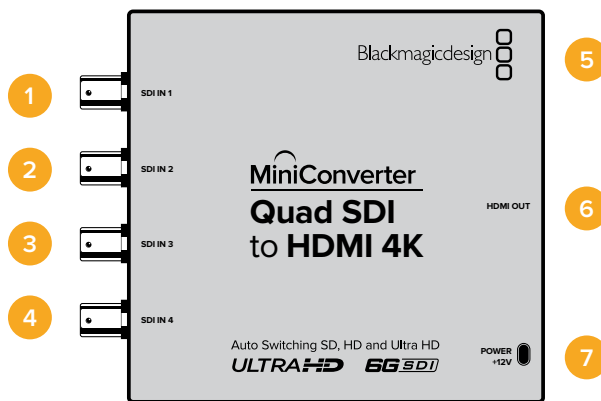

## Connectors

Supported formats are listed under each SDI input:

- 1 SDI In 1**
  - SD/HD-SDI
  - Single link 3G-SDI
  - Single link 6G-SDI
  - Dual link HD-SDI channel A
  - Dual link 3G-SDI Ultra HD channel A
  - Quad link HD-SDI Ultra HD channel A
- 2 SDI In 2**
  - Dual link HD-SDI channel B
  - Dual link 3G-SDI Ultra HD channel B
  - Quad link HD-SDI Ultra HD channel B
- 3 SDI In 3**
  - Quad link HD-SDI Ultra HD channel C
- 4 SDI In 4**
  - Quad link HD-SDI Ultra HD channel D

## 5 Mini-B USB port

Connects to the Converters Setup software via your Mac OS X or Windows computer. The Mini Converter's internal software is also updated using the USB port.

## 6 HDMI

HDMI type A video output.

## 7 Power +12V

12 volt power supply input.

### Mini Converter Quad SDI to HDMI 4K Block Diagram

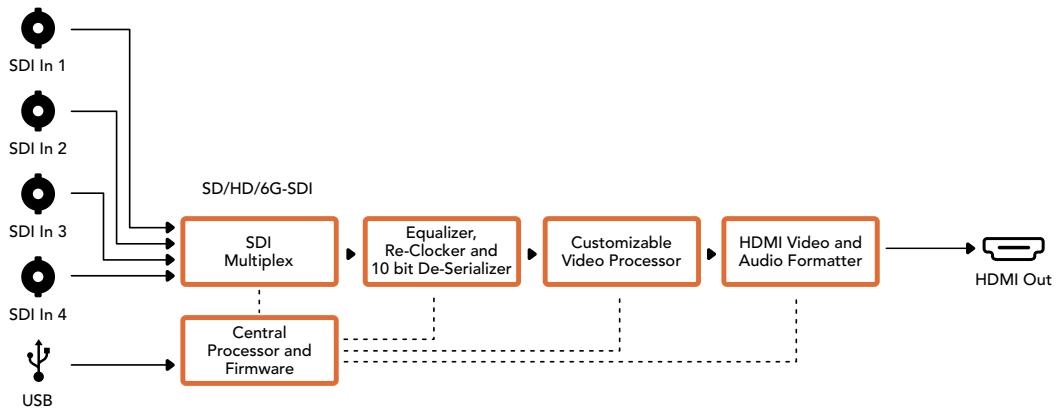

### Mini Converter SDI Distribution

With Mini Converter SDI Distribution you can output your SDI signal to eight SDI devices simultaneously, such as decks, monitor walls and switchers. Whenever the video input changes between SD-SDI, HD-SDI and 3G-SDI video formats, Mini Converter SDI Distribution automatically switches the 8 re-clocked outputs to match with support for ASI, ancillary data and embedded audio formats.

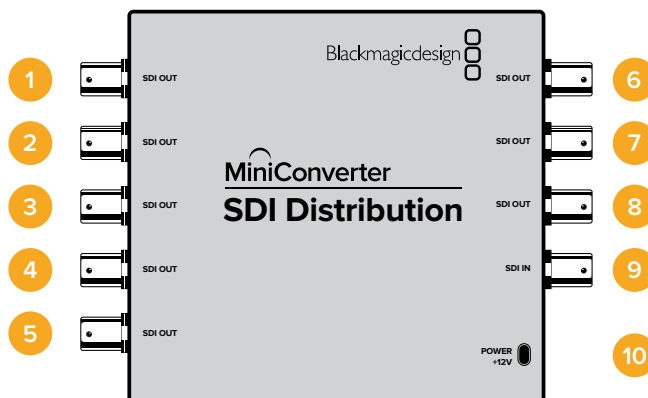

### Connectors

#### 1-8 SDI Out

SDI video outputs on BNC connectors.

#### 9 SDI In

SDI input.

#### 10 Power +12V

12 volt power supply input.

## Mini Converter SDI Distribution Block Diagram

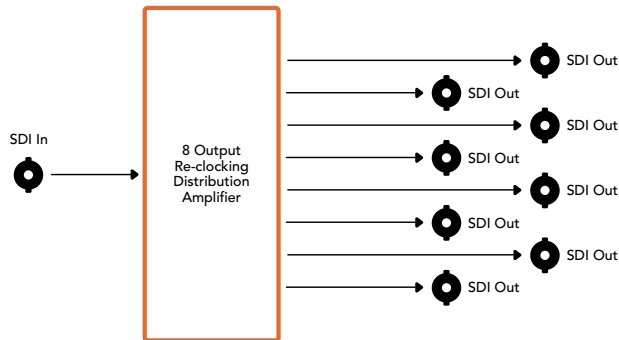

## Mini Converter SDI Distribution 4K

Your Mini Converter SDI Distribution 4K outputs your SDI signal to eight SDI devices simultaneously, such as decks, monitor walls and switchers. Whenever the video input changes between SD/HD/3G/6G-SDI video formats, Mini Converter SDI Distribution 4K automatically switches the 8 re-clocked outputs to match, with support for ASI, ancillary data and embedded audio formats.

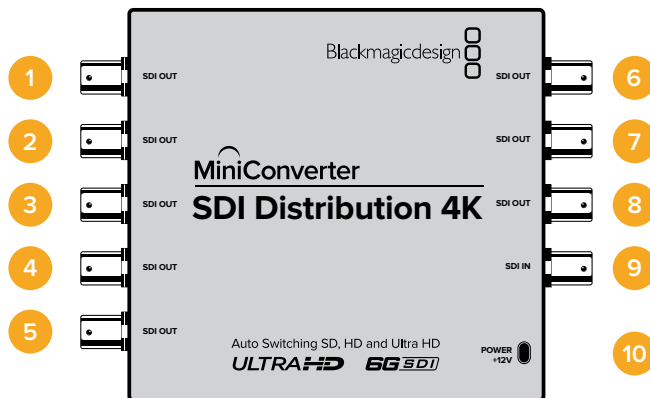

## Connectors

- 1-8 SDI Out**  
SDI video outputs on BNC connectors.
- 9 SDI In**  
SDI input.
- 10 Power +12V**  
12 volt power supply input.

## Mini Converter SDI Distribution 4K Block Diagram

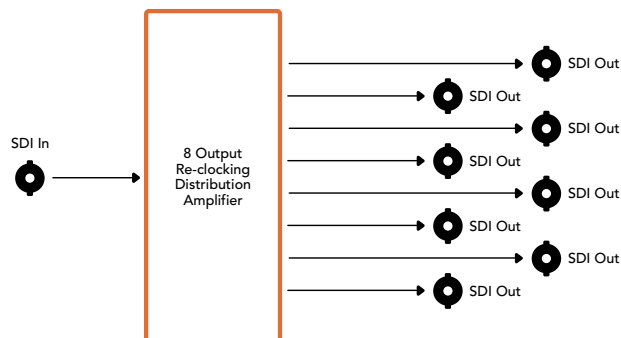



## Mini Converter SDI Multiplex 4K

Your Mini Converter SDI Multiplex 4K can perform the following conversions:

- Distribute an SD/HD and 6G-SDI signal to all four outputs.
- Distribute a dual link HD-SDI signal to all four 3G-SDI outputs.
- Single link 3G-SDI to dual link HD-SDI. The dual link output is distributed on both pairs of outputs.
- Single link 6G-SDI to dual link 3G-SDI or Quad link 1.5G-SDI.
- Quad link HD-SDI Ultra HD to single link 6G-SDI, or dual link 3G-SDI Ultra HD so you can connect existing Ultra HD sources to dual link Ultra HD displays. The dual link output is distributed on both pairs of outputs.
- Dual link 3G-SDI to single link 6G-SDI.
- Dual link 3G-SDI Ultra HD to quad link HD-SDI Ultra HD so you can connect the latest dual link Ultra HD sources to existing quad link Ultra HD displays.

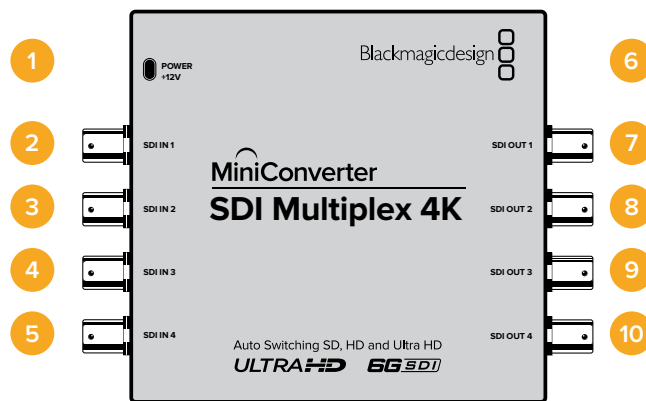

## Connectors

- 1 Power +12V**
  - 12 volt power supply input
  - Supported formats for each SDI input
- 2 SDI In 1**
  - SD/HD-SDI
  - Single link 3G-SDI
  - Single link 6G-SDI
  - Dual link HD-SDI channel A
  - Dual link 3G-SDI Ultra HD channel A
  - Quad link HD-SDI Ultra HD channel A
- 3 SDI In 2**
  - Dual link HD-SDI channel B
  - Dual link 3G-SDI Ultra HD channel B
  - Quad link HD-SDI Ultra HD channel B
- 4 SDI In 3**
  - Quad link HD-SDI Ultra HD channel C
- 5 SDI In 4**
  - Quad link HD-SDI Ultra HD channel D

## 6 Mini-B USB port

Connects to the Converters Setup software via your Mac OS X or Windows computer. The Mini Converter's internal software can also be updated using the USB port.

Supported formats are listed under each SDI output:

## 7 SDI Out 1

- SD/HD-SDI
- Single link 3G-SDI
- Single link 6G-SDI
- Dual link HD-SDI channel A
- Dual link 3G-SDI Ultra HD channel A
- Quad link HD-SDI Ultra HD channel A

## 8 SDI Out 2

- SD/HD-SDI
- Single link 3G-SDI
- Single link 6G-SDI
- Dual link HD-SDI channel B
- Dual link 3G-SDI Ultra HD channel B
- Quad link HD-SDI Ultra HD channel B

## 9 SDI Out 3

- SD/HD-SDI
- Single link 3G-SDI
- Single link 6G-SDI
- Dual link HD-SDI channel A
- Dual link 3G-SDI Ultra HD channel A
- Quad link HD-SDI Ultra HD channel C

## 10 SDI Out 4

- SD/HD-SDI
- Single link 3G-SDI
- Single link 6G-SDI
- Dual link HD-SDI channel B
- Dual link 3G-SDI Ultra HD channel B
- Quad link HD-SDI Ultra HD channel D

## Switches

Mini Converter SDI Multiplex 4K's switches provide the following settings:

### Switches 8, 7 and 6 - Format Conversion

Combinations of switches 8, 7 and 6 set conversions such as dual link HD-SDI to single link HD-SDI, or quad link Ultra HD to single link Ultra HD.

### Switch 1 - Processing ON/OFF

When switch 1 is set to OFF, Mini Converter SDI Multiplex 4K acts as a 4 output SD/HD/6G-SDI distribution amplifier.

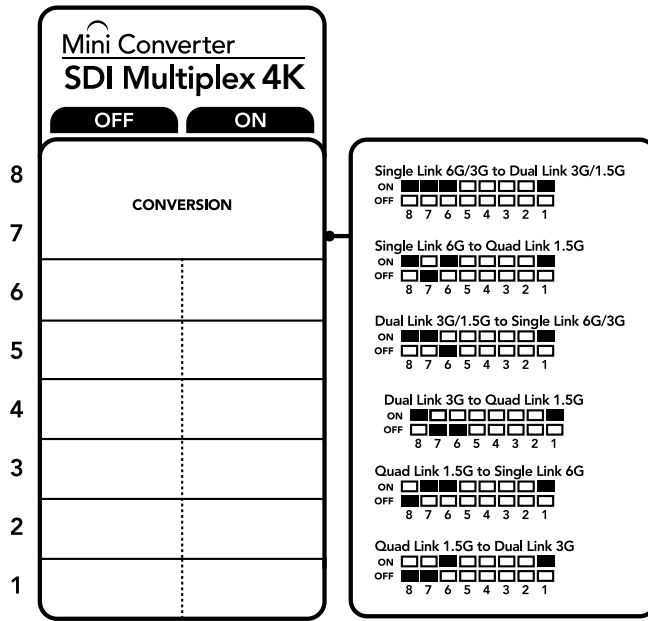

The switch legend on the base of your converter gives you all the information you need to change conversion settings.

### Mini Switch Settings Example

Convert quad link Ultra HD to dual link Ultra HD by setting switch 8 to ON, and switch 7 to OFF.

### SDI Connection Table

Conversion	Switch 8	Switch 7	Switch 6	Switch 1	Switch Diagram
Single Link 6G/3G-SDI to Dual Link 3G/1.5G-SDI	ON	ON	ON	ON	ON <input checked="" type="checkbox"/> <input checked="" type="checkbox"/> <input checked="" type="checkbox"/> <input type="checkbox"/> <input type="checkbox"/> <input type="checkbox"/> <input type="checkbox"/> <input type="checkbox"/> OFF <input type="checkbox"/> <input type="checkbox"/> <input type="checkbox"/> <input type="checkbox"/> <input type="checkbox"/> <input type="checkbox"/> <input type="checkbox"/> <input type="checkbox"/> 8 7 6 5 4 3 2 1
Single Link 6G-SDI to Quad Link 1.5G-SDI	ON	OFF	ON	ON	ON <input type="checkbox"/> <input type="checkbox"/> <input type="checkbox"/> <input type="checkbox"/> <input type="checkbox"/> <input type="checkbox"/> <input checked="" type="checkbox"/> <input checked="" type="checkbox"/> OFF <input type="checkbox"/> <input type="checkbox"/> <input type="checkbox"/> <input type="checkbox"/> <input type="checkbox"/> <input type="checkbox"/> <input type="checkbox"/> <input type="checkbox"/> 8 7 6 5 4 3 2 1
Dual Link 3G/1.5G-SDI to Single Link 6G/3G-SDI	ON	ON	OFF	ON	ON <input checked="" type="checkbox"/> <input type="checkbox"/> <input type="checkbox"/> <input type="checkbox"/> <input type="checkbox"/> <input type="checkbox"/> <input type="checkbox"/> <input type="checkbox"/> OFF <input type="checkbox"/> <input type="checkbox"/> <input type="checkbox"/> <input type="checkbox"/> <input type="checkbox"/> <input type="checkbox"/> <input type="checkbox"/> <input type="checkbox"/> 8 7 6 5 4 3 2 1
Dual Link 3G-SDI to Quad Link 1.5G-SDI	ON	OFF	OFF	ON	ON <input type="checkbox"/> <input type="checkbox"/> <input type="checkbox"/> <input type="checkbox"/> <input type="checkbox"/> <input type="checkbox"/> <input checked="" type="checkbox"/> <input checked="" type="checkbox"/> OFF <input type="checkbox"/> <input type="checkbox"/> <input type="checkbox"/> <input type="checkbox"/> <input type="checkbox"/> <input type="checkbox"/> <input type="checkbox"/> <input type="checkbox"/> 8 7 6 5 4 3 2 1
Quad Link 1.5G-SDI to Single Link 6G-SDI	OFF	ON	ON	ON	ON <input type="checkbox"/> <input checked="" type="checkbox"/> <input checked="" type="checkbox"/> <input checked="" type="checkbox"/> <input checked="" type="checkbox"/> <input checked="" type="checkbox"/> <input type="checkbox"/> <input type="checkbox"/> OFF <input type="checkbox"/> <input type="checkbox"/> <input type="checkbox"/> <input type="checkbox"/> <input type="checkbox"/> <input type="checkbox"/> <input type="checkbox"/> <input type="checkbox"/> 8 7 6 5 4 3 2 1
Quad Link 1.5G-SDI to Dual Link 3G-SDI	OFF	OFF	ON	ON	ON <input type="checkbox"/> <input type="checkbox"/> <input type="checkbox"/> <input type="checkbox"/> <input type="checkbox"/> <input type="checkbox"/> <input checked="" type="checkbox"/> <input checked="" type="checkbox"/> OFF <input type="checkbox"/> <input type="checkbox"/> <input type="checkbox"/> <input type="checkbox"/> <input type="checkbox"/> <input type="checkbox"/> <input type="checkbox"/> <input type="checkbox"/> 8 7 6 5 4 3 2 1

## Mini Converter SDI Multiplex 4K Block Diagram

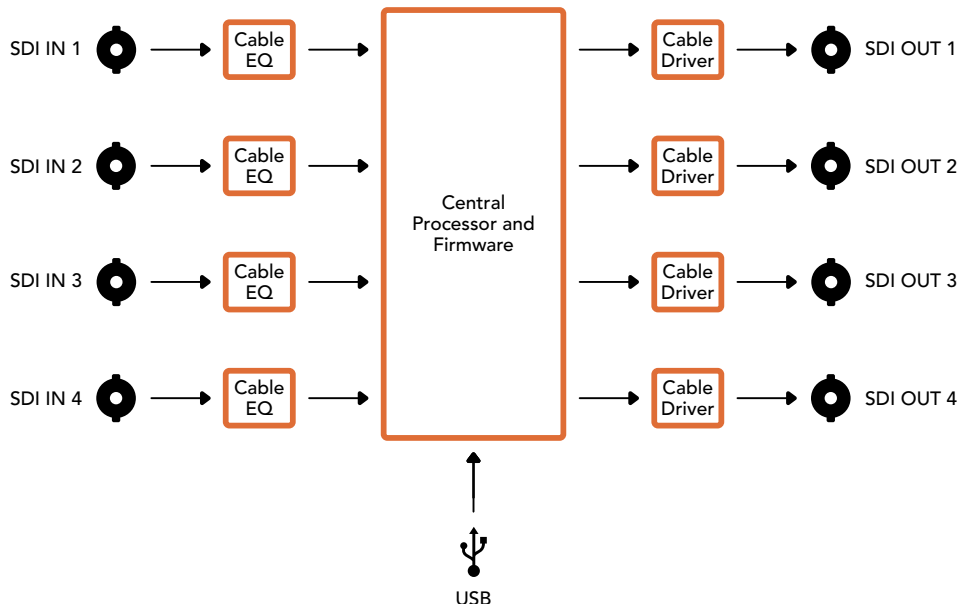

## Mini Converter Sync Generator

Your Mini Converter Sync Generator includes 6 crystal stabilized video reference outputs for locking your video equipment to a common reference signal. Sync Generator produces high definition tri-sync or standard definition blackburst signals and is perfect for small studios and outside broadcasts.

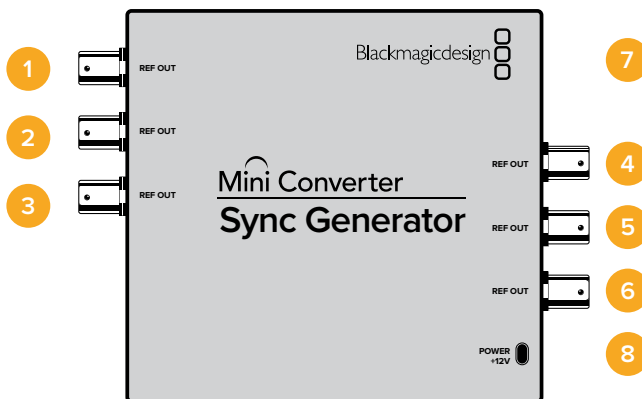

## Connectors

### 1-6 REF Out

Reference video outputs BNC connectors.

### 7 Mini-B USB port

Connects to the Converters Setup software via your Mac OS X or Windows computer. The Mini Converter's internal software is also updated using the USB port.

### 8 Power +12V

12 volt power supply input.

## Switches

Mini Converter Sync Generator's switches provide the following settings:

### Switch 4, 3, 2 and 1 - SYNC REF FORMAT BIT 3, 2, 1 and 0



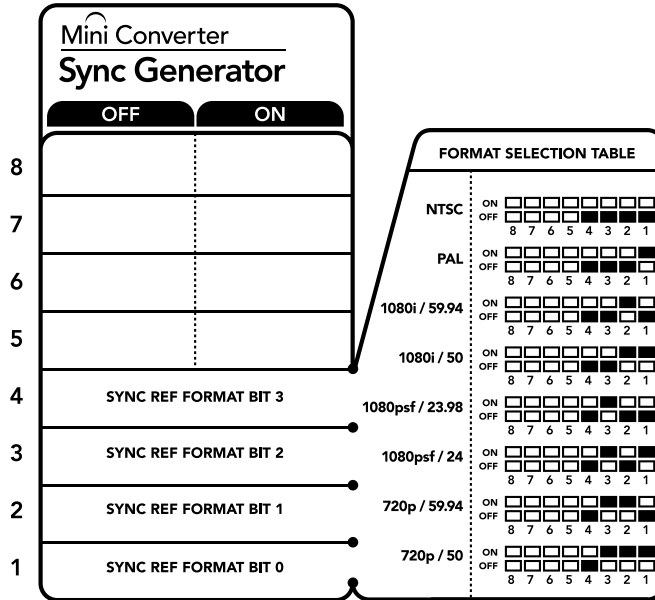



Switches 4, 3, 2 and 1 are grouped together to select from many reference video formats, including:



The switch legend on the base of your converter gives you all the information you need to change conversion settings.

### Video Format Selection Table

Video Format	Switch 4	Switch 3	Switch 2	Switch 1	Switch Diagram
NTSC	OFF	OFF	OFF	OFF	ON OFF <input type="checkbox"/> <input type="checkbox"/> <input type="checkbox"/> <input type="checkbox"/> <input type="checkbox"/> <input type="checkbox"/> <input type="checkbox"/> <input type="checkbox"/> <input type="checkbox"/> <input type="checkbox"/> <input type="checkbox"/> <input type="checkbox"/> <input type="checkbox"/> <input type="checkbox"/> <input type="checkbox"/> <input type="checkbox"/> <input type="checkbox"/> 8 7 6 5 4 3 2 1
PAL	OFF	OFF	OFF	ON	ON OFF <input type="checkbox"/> <input type="checkbox"/> <input type="checkbox"/> <input type="checkbox"/> <input type="checkbox"/> <input type="checkbox"/> <input type="checkbox"/> <input type="checkbox"/> <input type="checkbox"/> <input type="checkbox"/> <input type="checkbox"/> <input type="checkbox"/> <input type="checkbox"/> <input type="checkbox"/> <input type="checkbox"/> <input type="checkbox"/> <input type="checkbox"/> 8 7 6 5 4 3 2 1
720p50	OFF	ON	ON	ON	ON OFF <input type="checkbox"/> <input type="checkbox"/> <input type="checkbox"/> <input type="checkbox"/> <input type="checkbox"/> <input type="checkbox"/> <input type="checkbox"/> <input type="checkbox"/> <input type="checkbox"/> <input type="checkbox"/> <input type="checkbox"/> <input type="checkbox"/> <input type="checkbox"/> <input type="checkbox"/> <input type="checkbox"/> <input type="checkbox"/> <input type="checkbox"/> 8 7 6 5 4 3 2 1
720p59.94	OFF	ON	ON	OFF	ON OFF <input type="checkbox"/> <input type="checkbox"/> <input type="checkbox"/> <input type="checkbox"/> <input type="checkbox"/> <input type="checkbox"/> <input type="checkbox"/> <input type="checkbox"/> <input type="checkbox"/> <input type="checkbox"/> <input type="checkbox"/> <input type="checkbox"/> <input type="checkbox"/> <input type="checkbox"/> <input type="checkbox"/> <input type="checkbox"/> <input type="checkbox"/> 8 7 6 5 4 3 2 1
720p60	ON	ON	ON	OFF	ON OFF <input type="checkbox"/> <input type="checkbox"/> <input type="checkbox"/> <input type="checkbox"/> <input type="checkbox"/> <input type="checkbox"/> <input type="checkbox"/> <input type="checkbox"/> <input type="checkbox"/> <input type="checkbox"/> <input type="checkbox"/> <input type="checkbox"/> <input type="checkbox"/> <input type="checkbox"/> <input type="checkbox"/> <input type="checkbox"/> <input type="checkbox"/> 8 7 6 5 4 3 2 1
1080i50	OFF	OFF	ON	ON	ON OFF <input type="checkbox"/> <input type="checkbox"/> <input type="checkbox"/> <input type="checkbox"/> <input type="checkbox"/> <input type="checkbox"/> <input type="checkbox"/> <input type="checkbox"/> <input type="checkbox"/> <input type="checkbox"/> <input type="checkbox"/> <input type="checkbox"/> <input type="checkbox"/> <input type="checkbox"/> <input type="checkbox"/> <input type="checkbox"/> <input type="checkbox"/> 8 7 6 5 4 3 2 1

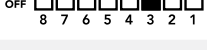
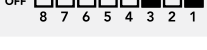
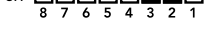
Video Format	Switch 4	Switch 3	Switch 2	Switch 1	Switch Diagram
1080i59.94	OFF	OFF	ON	OFF	ON OFF 
1080i60	ON	OFF	OFF	OFF	ON OFF 
1080PsF23.98	OFF	ON	OFF	OFF	ON OFF 
1080PsF24	OFF	ON	OFF	ON	ON OFF 
1080p23.98	ON	ON	OFF	ON	ON OFF 
1080p24	ON	ON	OFF	OFF	ON OFF 
1080p25	ON	OFF	ON	ON	ON OFF 
1080p29.97	ON	OFF	ON	OFF	ON OFF 
1080p30	ON	OFF	OFF	ON	ON OFF 

Mini Converter Sync Generator Block Diagram

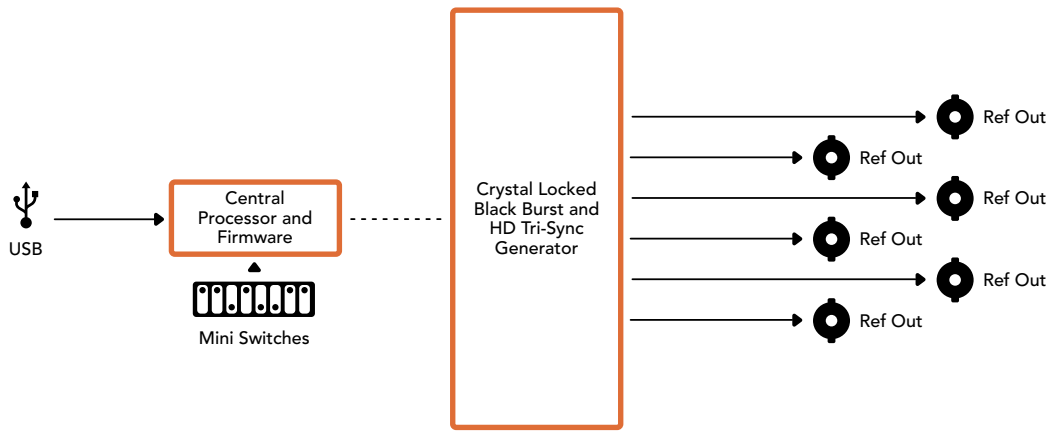

## Mini Converter UpDownCross

Your Mini Converter UpDownCross performs up, down and cross conversions as well as NTSC/PAL standards conversion and format conversion. Mini Converter UpDownCross can convert between video formats such as 720p to 1080i and PAL and NTSC video standards. It also provides up conversions with aspect ratios such as 4:3 Pillarbox and 16:9 zoom, and down conversion options such as letterbox 4:3 and anamorphic 16:9.

When conversion processing is set to OFF, the Mini Converter acts as an SDI distribution amplifier.

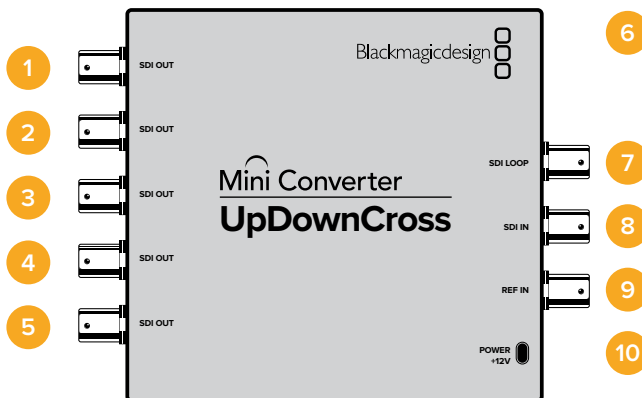

## Connectors

### 1-5 SDI Out

SDI video outputs BNC connectors.

### 6 Mini-B USB port

Connects to the Converters Setup software via your Mac OS X or Windows computer. The Mini Converter's internal software is also updated using the USB port.

### 7 SDI LOOP

Direct output of your input video.

### 8 SDI IN

SDI Input.

### 9 REF IN

Reference video input.

### 10 Power +12V

12 volt power supply input.



## Switches

Mini Converter UpDownCross' switches provide the following settings:

### Switch 8 - Aspect Ratio Conversion

Combinations of switches 8 and 7 set the video aspect ratio when up or down converting. For example, when down converting, the letterbox aspect ratio is applied by setting switches 8 and 7 to the OFF position.

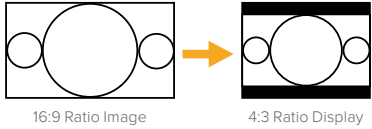
## Aspect Ratio Conversion Table

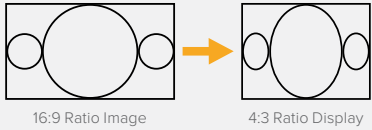
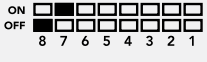
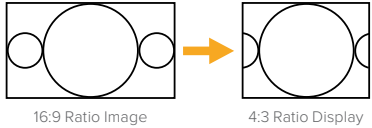
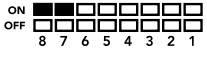
Down conversion		Switch 8	Switch 7	Switch Diagram
Letterbox	 <p>16:9 Ratio Image → 4:3 Ratio Display</p>	OFF	OFF	ON <input type="checkbox"/> <input type="checkbox"/> <input type="checkbox"/> <input type="checkbox"/> <input type="checkbox"/> <input type="checkbox"/> <input type="checkbox"/> <input type="checkbox"/> <input type="checkbox"/> <input type="checkbox"/> OFF <input checked="" type="checkbox"/> <input type="checkbox"/> <input type="checkbox"/> <input type="checkbox"/> <input type="checkbox"/> <input type="checkbox"/> <input type="checkbox"/> <input type="checkbox"/> <input type="checkbox"/> <input type="checkbox"/>
Anamorphic	 <p>16:9 Ratio Image → 4:3 Ratio Display</p>	OFF	ON	ON <input type="checkbox"/> <input type="checkbox"/> <input type="checkbox"/> <input type="checkbox"/> <input type="checkbox"/> <input type="checkbox"/> <input type="checkbox"/> <input type="checkbox"/> <input type="checkbox"/> <input type="checkbox"/> OFF <input checked="" type="checkbox"/> <input type="checkbox"/> <input type="checkbox"/> <input type="checkbox"/> <input type="checkbox"/> <input type="checkbox"/> <input type="checkbox"/> <input type="checkbox"/> <input type="checkbox"/> <input type="checkbox"/>
Center Cut	 <p>16:9 Ratio Image → 4:3 Ratio Display</p>	ON	ON	ON <input checked="" type="checkbox"/> <input type="checkbox"/> <input type="checkbox"/> <input type="checkbox"/> <input type="checkbox"/> <input type="checkbox"/> <input type="checkbox"/> <input type="checkbox"/> <input type="checkbox"/> <input type="checkbox"/> OFF <input type="checkbox"/> <input type="checkbox"/> <input type="checkbox"/> <input type="checkbox"/> <input type="checkbox"/> <input type="checkbox"/> <input type="checkbox"/> <input type="checkbox"/> <input type="checkbox"/> <input type="checkbox"/>
Up conversion		Switch 8	Switch 7	Switch Diagram
4:3 Pillarbox	 <p>4:3 Ratio Image → 16:9 Ratio Display</p>	OFF	OFF	ON <input type="checkbox"/> <input type="checkbox"/> <input type="checkbox"/> <input type="checkbox"/> <input type="checkbox"/> <input type="checkbox"/> <input type="checkbox"/> <input type="checkbox"/> <input type="checkbox"/> <input type="checkbox"/> OFF <input checked="" type="checkbox"/> <input type="checkbox"/> <input type="checkbox"/> <input type="checkbox"/> <input type="checkbox"/> <input type="checkbox"/> <input type="checkbox"/> <input type="checkbox"/> <input type="checkbox"/> <input type="checkbox"/>
14:9 Pillarbox	 <p>4:3 Ratio Image → 16:9 Ratio Display</p>	OFF	ON	ON <input type="checkbox"/> <input type="checkbox"/> <input type="checkbox"/> <input type="checkbox"/> <input type="checkbox"/> <input type="checkbox"/> <input type="checkbox"/> <input type="checkbox"/> <input type="checkbox"/> <input type="checkbox"/> OFF <input checked="" type="checkbox"/> <input type="checkbox"/> <input type="checkbox"/> <input type="checkbox"/> <input type="checkbox"/> <input type="checkbox"/> <input type="checkbox"/> <input type="checkbox"/> <input type="checkbox"/> <input type="checkbox"/>
16:9 De-Squeeze	 <p>4:3 Ratio Display → 16:9 Ratio Image</p>	ON	ON	ON <input checked="" type="checkbox"/> <input type="checkbox"/> <input type="checkbox"/> <input type="checkbox"/> <input type="checkbox"/> <input type="checkbox"/> <input type="checkbox"/> <input type="checkbox"/> <input type="checkbox"/> <input type="checkbox"/> OFF <input type="checkbox"/> <input type="checkbox"/> <input type="checkbox"/> <input type="checkbox"/> <input type="checkbox"/> <input type="checkbox"/> <input type="checkbox"/> <input type="checkbox"/> <input type="checkbox"/> <input type="checkbox"/>

You've probably noticed switches 8 and 7 share settings for up and down conversions. This is because aspect ratio settings are determined by the output settings. For example, if you have switches 3 and 2 set for 1080i50 HD output, and processing switch 1 set to ON, Mini Converter UpDownCross will automatically set switches 8 and 7 for down conversion.



Below is a description for each aspect ratio conversion:

**Up conversion**

- **4:3 Pillarbox:** This setting displays 4:3 standard definition inside a high definition 16:9 frame. Black bars feature on the sides.
- **14:9 Pillarbox:** This setting is a compromise between 4:3 pillarbox and 16:9 zoom. The standard definition 4:3 image is slightly zoomed into, allowing more image in the 16:9 frame and reducing the amount of black bars on the sides, but slightly losing the top and bottom.
- **16:9 De-Squeeze:** This setting de-squeezes the standard definition 4:3 anamorphic image until it completely fills the 16:9 frame. None of the 4:3 image is lost.

**Down conversion**

- **Letterbox:** This setting scales the entire 16:9 HD image into a 4:3 SD frame without squeezing, leaving black bars on the top and bottom.
- **Anamorphic:** This setting horizontally squeezes the 16:9 HD image into a 4:3 SD frame.
- **Center Cut:** This setting cuts a 4:3 SD frame from the 16:9 HD image. This aspect ratio setting discards a portion from each side of the 16:9 image.

**Switch 1 - Processing Off - Processing On**

When switch 1 is set to OFF all conversions are bypassed and the Mini Converter can be used to distribute your video to six SDI devices.

**Mini Switch Settings Example:**

Set the converter to up convert 4:3 625i50 video to 1080i50 with the 4:3 Pillarbox aspect ratio by setting switches 8 and 7 to the OFF position and switches 3, 2 and 1 to the ON position.

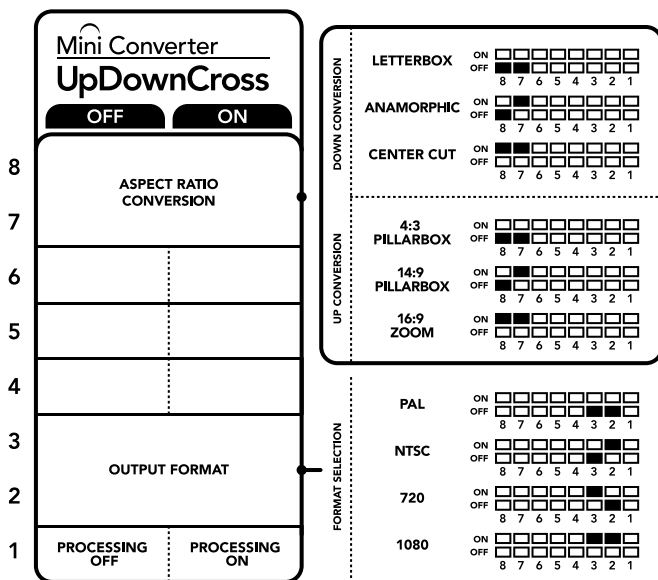

The switch legend on the base of your converter gives you all the information you need to change conversion settings.

## Mini Converter UpDownCross Conversion Table

Input Video	NTSC Switches 1 and 2 ON	PAL Switch 1 ON	720p Switches 1 and 3 ON	1080 Switches 1, 2 and 3 ON
525i59.94	525i59.94	625i50	720p59.94	1080i59.94
625i50	525i59.94	625i50	720p50	1080i50
720p50	525i59.94	625i50	720p50	1080i50
720p59.94	525i59.94	625i50	720p59.94	1080i59.94
720p60	525i59.94	625i50	720p60	1080i60
1080PsF23.98	525i59.94	625i50	720p59.94	1080PsF23.98
1080p23.98	525i59.94	625i50	720p59.94	1080p23.98
1080PsF24	525i59.94	625i50	720p50	1080PsF24
1080p24	525i59.94	625i50	720p50	1080p24
1080p25	525i59.94	625i50	720p50	1080p25
1080p29.97	525i59.94	625i50	720p59.94	1080p29.97
1080p30	525i59.94	625i50	720p60	1080p30
1080i50	525i59.94	625i50	720p50	1080i50
1080i59.94	525i59.94	625i50	720p59.94	1080i59.94
1080i60	525i59.94	625i50	720p60	1080i60
1080p50	525i59.94	625i50	720p50	1080p50
1080p59.94	525i59.94	625i50	720p59.94	1080p59.94
1080p60	525i59.94	625i50	720p60	1080p60
2048x1556PsF23.98	525i59.94	625i50	2048x1556PsF23.98	2048x1556PsF23.98
2048x1556PsF24	525i59.94	625i50	2048x1556PsF24	2048x1556PsF24
2048x1556PsF25	525i59.94	625i50	2048x1556PsF25	2048x1556PsF25

## Mini Converter UpDownCross Block Diagram

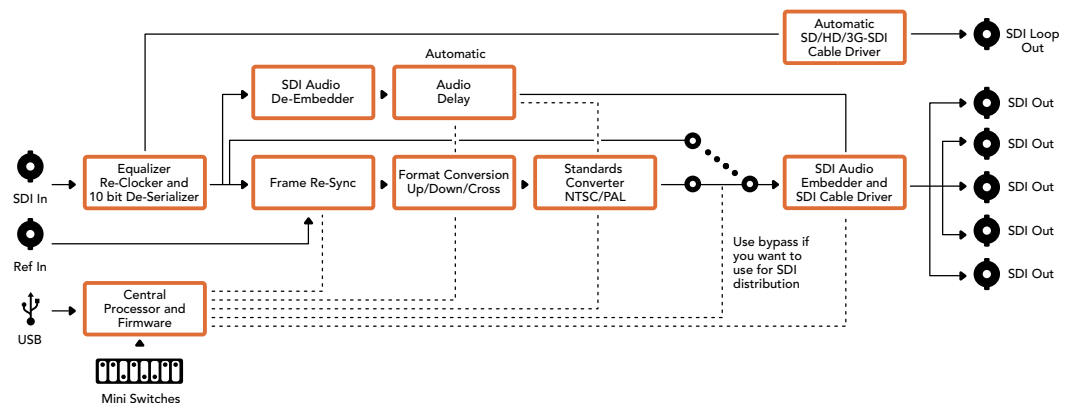

## Mini Converter UpDownCross HD

Mini Converter UpDownCross HD is a powerful standards converter that gives you the ability to convert any SD or HD video format with up, down, or cross conversion via SDI and HDMI. This converter supports all SD and HD formats up to 1080p60 plus NTSC and PAL with aspect ratio options for up and down conversions. The HDMI input also accepts 1024 x 768, 800 x 600, and 640 x 480 computer output resolutions.

When conversion processing is set to OFF the HDMI and SDI outputs become loop outputs so you can feed the input signal to other HDMI and SDI equipment.

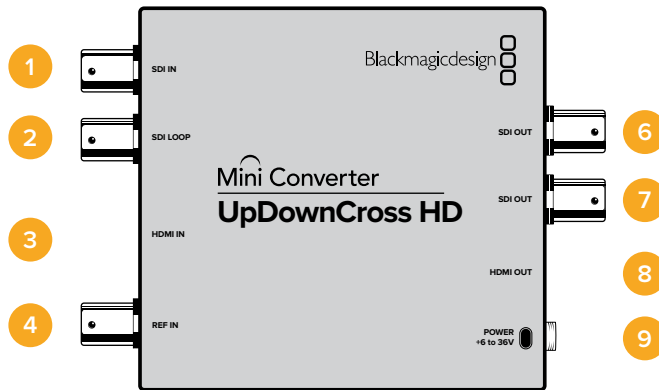

## Connectors

### 1 SDI IN

SDI input. The small LED next to the BNC connector illuminates when a locked SDI signal is detected. When both SDI and HDMI inputs are connected, the SDI input takes priority.

### 2 SDI LOOP

Direct loop output of your SDI input video.

### 3 HDMI IN

HDMI type A video input. A small LED next to the HDMI IN connector illuminates to show when it detects a valid HDMI input.

### 4 REF IN

Reference video input. A small LED next to the REF IN connector indicates the reference lock status:

**Constant white** - the REF IN matches the format of the output video format set on the converter.

**Flashing white** - the REF IN is a valid video format but doesn't match the output video format set on the converter.

### 5 USB-C PORT

Connects to the Converters Setup software via your Mac OS X or Windows computer. The Mini Converter's internal software is also updated using the USB port.

### 6-7 SDI OUT

SDI video output BNC connectors.

### 8 HDMI OUT

HDMI type A video output.

### 9 POWER +6 to 36V

6 to 36 volt power supply input. The support screw can be secured to the unit's power connector to prevent accidental disconnection. A small LED next to the DC input jack illuminates to show when power is connected.

## Switches

Mini Converter UpDownCross HD's switches provide the following settings :

### Switch 1 - Processing Off - Processing On

When switch 1 is set to OFF all conversions are bypassed and the converter can be used to distribute your video via both SDI and HDMI outputs.

With switch 1 set to OFF the SDI and HDMI outputs match their corresponding inputs.

When switch 1 is set to ON, processing is enabled and switches 4 to 8 configure the converter's output.

### Switch 2 - Level A and Level B 3G-SDI

When switch 2 is set to OFF the converter outputs level B 3G-SDI. When set to ON the converter outputs level A 3G-SDI. This provides compatibility with other SDI equipment that uses level A or level B 3G-SDI.

**TIP** If you have connected a 3G-SDI signal to 3G-SDI equipment and the signal is not being detected, try changing the setting for switch 2 as the equipment you're connected to may be using an alternate SDI level.

### Switches 4 - 8

Switches 4 to 8 determine the format and standard of the converter's output signal. The switch configuration for each format and standard is shown on the table on the base of the unit.

Mini Switch Settings Example:

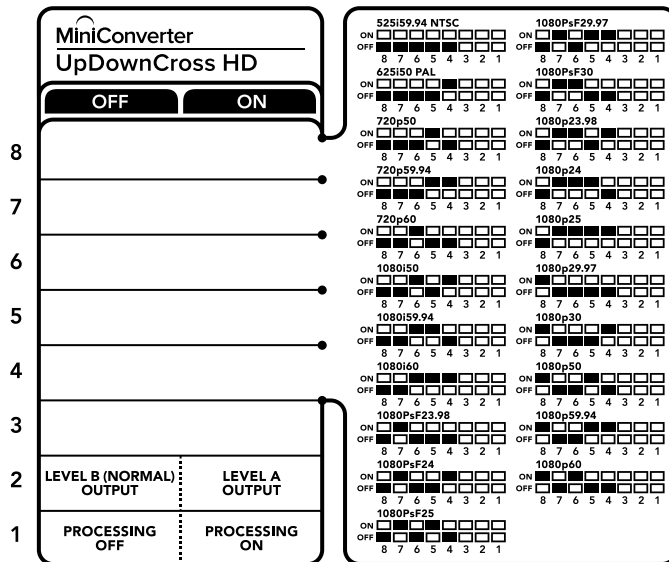

## Video Format Selection Table

Video Format	Switch 8	Switch 7	Switch 6	Switch 5	Switch 4	Switch Diagram
525i59.94 NTSC	OFF	OFF	OFF	OFF	OFF	ON <input type="checkbox"/> <input type="checkbox"/> <input type="checkbox"/> <input type="checkbox"/> <input type="checkbox"/> <input type="checkbox"/> <input type="checkbox"/> <input type="checkbox"/> OFF <input checked="" type="checkbox"/> <input checked="" type="checkbox"/> <input checked="" type="checkbox"/> <input checked="" type="checkbox"/> <input checked="" type="checkbox"/> <input checked="" type="checkbox"/> <input checked="" type="checkbox"/> <input checked="" type="checkbox"/>
625i50 PAL	OFF	OFF	OFF	OFF	ON	ON <input type="checkbox"/> <input type="checkbox"/> <input type="checkbox"/> <input type="checkbox"/> <input type="checkbox"/> <input type="checkbox"/> <input type="checkbox"/> <input type="checkbox"/> OFF <input checked="" type="checkbox"/> <input checked="" type="checkbox"/> <input checked="" type="checkbox"/> <input checked="" type="checkbox"/> <input checked="" type="checkbox"/> <input checked="" type="checkbox"/> <input checked="" type="checkbox"/> <input checked="" type="checkbox"/>
720p50	OFF	OFF	OFF	ON	OFF	ON <input type="checkbox"/> <input type="checkbox"/> <input checked="" type="checkbox"/> <input type="checkbox"/> <input type="checkbox"/> <input type="checkbox"/> <input type="checkbox"/> <input type="checkbox"/> OFF <input checked="" type="checkbox"/> <input checked="" type="checkbox"/> <input checked="" type="checkbox"/> <input checked="" type="checkbox"/> <input checked="" type="checkbox"/> <input checked="" type="checkbox"/> <input checked="" type="checkbox"/> <input checked="" type="checkbox"/>
720p59.94	OFF	OFF	OFF	ON	ON	ON <input type="checkbox"/> <input type="checkbox"/> <input checked="" type="checkbox"/> <input type="checkbox"/> <input type="checkbox"/> <input type="checkbox"/> <input type="checkbox"/> <input type="checkbox"/> OFF <input checked="" type="checkbox"/> <input checked="" type="checkbox"/> <input checked="" type="checkbox"/> <input checked="" type="checkbox"/> <input checked="" type="checkbox"/> <input checked="" type="checkbox"/> <input checked="" type="checkbox"/> <input checked="" type="checkbox"/>
720p60	OFF	OFF	ON	OFF	ON	ON <input type="checkbox"/> <input type="checkbox"/> <input type="checkbox"/> <input checked="" type="checkbox"/> <input type="checkbox"/> <input type="checkbox"/> <input type="checkbox"/> <input type="checkbox"/> OFF <input checked="" type="checkbox"/> <input checked="" type="checkbox"/> <input checked="" type="checkbox"/> <input checked="" type="checkbox"/> <input checked="" type="checkbox"/> <input checked="" type="checkbox"/> <input checked="" type="checkbox"/> <input checked="" type="checkbox"/>
1080i50	OFF	OFF	ON	OFF	ON	ON <input type="checkbox"/> <input type="checkbox"/> <input type="checkbox"/> <input checked="" type="checkbox"/> <input type="checkbox"/> <input type="checkbox"/> <input type="checkbox"/> <input type="checkbox"/> OFF <input checked="" type="checkbox"/> <input checked="" type="checkbox"/> <input checked="" type="checkbox"/> <input checked="" type="checkbox"/> <input checked="" type="checkbox"/> <input checked="" type="checkbox"/> <input checked="" type="checkbox"/> <input checked="" type="checkbox"/>
1080i59.94	OFF	OFF	ON	ON	OFF	ON <input type="checkbox"/> <input type="checkbox"/> <input checked="" type="checkbox"/> <input type="checkbox"/> <input type="checkbox"/> <input type="checkbox"/> <input type="checkbox"/> <input type="checkbox"/> OFF <input checked="" type="checkbox"/> <input checked="" type="checkbox"/> <input checked="" type="checkbox"/> <input checked="" type="checkbox"/> <input checked="" type="checkbox"/> <input checked="" type="checkbox"/> <input checked="" type="checkbox"/> <input checked="" type="checkbox"/>
1080i60	OFF	OFF	ON	ON	ON	ON <input type="checkbox"/> <input type="checkbox"/> <input checked="" type="checkbox"/> <input type="checkbox"/> <input type="checkbox"/> <input type="checkbox"/> <input type="checkbox"/> <input type="checkbox"/> OFF <input checked="" type="checkbox"/> <input checked="" type="checkbox"/> <input checked="" type="checkbox"/> <input checked="" type="checkbox"/> <input checked="" type="checkbox"/> <input checked="" type="checkbox"/> <input checked="" type="checkbox"/> <input checked="" type="checkbox"/>
1080PsF23.98	OFF	ON	OFF	OFF	OFF	ON <input type="checkbox"/> <input checked="" type="checkbox"/> <input type="checkbox"/> <input type="checkbox"/> <input type="checkbox"/> <input type="checkbox"/> <input type="checkbox"/> <input type="checkbox"/> OFF <input checked="" type="checkbox"/> <input checked="" type="checkbox"/> <input checked="" type="checkbox"/> <input checked="" type="checkbox"/> <input checked="" type="checkbox"/> <input checked="" type="checkbox"/> <input checked="" type="checkbox"/> <input checked="" type="checkbox"/>
1080PsF24	OFF	ON	OFF	OFF	ON	ON <input type="checkbox"/> <input type="checkbox"/> <input checked="" type="checkbox"/> <input type="checkbox"/> <input type="checkbox"/> <input type="checkbox"/> <input type="checkbox"/> <input type="checkbox"/> OFF <input checked="" type="checkbox"/> <input checked="" type="checkbox"/> <input checked="" type="checkbox"/> <input checked="" type="checkbox"/> <input checked="" type="checkbox"/> <input checked="" type="checkbox"/> <input checked="" type="checkbox"/> <input checked="" type="checkbox"/>
1080PsF25	OFF	ON	OFF	ON	OFF	ON <input type="checkbox"/> <input checked="" type="checkbox"/> <input type="checkbox"/> <input type="checkbox"/> <input type="checkbox"/> <input type="checkbox"/> <input type="checkbox"/> <input type="checkbox"/> OFF <input checked="" type="checkbox"/> <input checked="" type="checkbox"/> <input checked="" type="checkbox"/> <input checked="" type="checkbox"/> <input checked="" type="checkbox"/> <input checked="" type="checkbox"/> <input checked="" type="checkbox"/> <input checked="" type="checkbox"/>
1080PsF29.97	OFF	ON	OFF	ON	ON	ON <input type="checkbox"/> <input type="checkbox"/> <input checked="" type="checkbox"/> <input type="checkbox"/> <input type="checkbox"/> <input type="checkbox"/> <input type="checkbox"/> <input type="checkbox"/> OFF <input checked="" type="checkbox"/> <input checked="" type="checkbox"/> <input checked="" type="checkbox"/> <input checked="" type="checkbox"/> <input checked="" type="checkbox"/> <input checked="" type="checkbox"/> <input checked="" type="checkbox"/> <input checked="" type="checkbox"/>
1080PsF30	OFF	ON	ON	OFF	OFF	ON <input type="checkbox"/> <input checked="" type="checkbox"/> <input type="checkbox"/> <input checked="" type="checkbox"/> <input type="checkbox"/> <input type="checkbox"/> <input type="checkbox"/> <input type="checkbox"/> OFF <input checked="" type="checkbox"/> <input checked="" type="checkbox"/> <input checked="" type="checkbox"/> <input checked="" type="checkbox"/> <input checked="" type="checkbox"/> <input checked="" type="checkbox"/> <input checked="" type="checkbox"/> <input checked="" type="checkbox"/>
1080p23.98	OFF	ON	ON	OFF	ON	ON <input type="checkbox"/> <input checked="" type="checkbox"/> <input type="checkbox"/> <input checked="" type="checkbox"/> <input type="checkbox"/> <input type="checkbox"/> <input type="checkbox"/> <input type="checkbox"/> OFF <input checked="" type="checkbox"/> <input checked="" type="checkbox"/> <input checked="" type="checkbox"/> <input checked="" type="checkbox"/> <input checked="" type="checkbox"/> <input checked="" type="checkbox"/> <input checked="" type="checkbox"/> <input checked="" type="checkbox"/>
1080p24	OFF	ON	ON	ON	OFF	ON <input type="checkbox"/> <input checked="" type="checkbox"/> <input type="checkbox"/> <input checked="" type="checkbox"/> <input type="checkbox"/> <input type="checkbox"/> <input type="checkbox"/> <input type="checkbox"/> OFF <input checked="" type="checkbox"/> <input checked="" type="checkbox"/> <input checked="" type="checkbox"/> <input checked="" type="checkbox"/> <input checked="" type="checkbox"/> <input checked="" type="checkbox"/> <input checked="" type="checkbox"/> <input checked="" type="checkbox"/>
1080p25	OFF	ON	ON	ON	ON	ON <input type="checkbox"/> <input checked="" type="checkbox"/> <input type="checkbox"/> <input checked="" type="checkbox"/> <input type="checkbox"/> <input type="checkbox"/> <input type="checkbox"/> <input type="checkbox"/> OFF <input checked="" type="checkbox"/> <input checked="" type="checkbox"/> <input checked="" type="checkbox"/> <input checked="" type="checkbox"/> <input checked="" type="checkbox"/> <input checked="" type="checkbox"/> <input checked="" type="checkbox"/> <input checked="" type="checkbox"/>
1080p29.97	OFF	ON	ON	ON	OFF	ON <input type="checkbox"/> <input checked="" type="checkbox"/> <input type="checkbox"/> <input checked="" type="checkbox"/> <input type="checkbox"/> <input type="checkbox"/> <input type="checkbox"/> <input type="checkbox"/> OFF <input checked="" type="checkbox"/> <input checked="" type="checkbox"/> <input checked="" type="checkbox"/> <input checked="" type="checkbox"/> <input checked="" type="checkbox"/> <input checked="" type="checkbox"/> <input checked="" type="checkbox"/> <input checked="" type="checkbox"/>
1080p30	ON	OFF	OFF	OFF	ON	ON <input checked="" type="checkbox"/> <input type="checkbox"/> <input type="checkbox"/> <input type="checkbox"/> <input type="checkbox"/> <input type="checkbox"/> <input type="checkbox"/> <input type="checkbox"/> OFF <input type="checkbox"/> <input checked="" type="checkbox"/> <input checked="" type="checkbox"/> <input checked="" type="checkbox"/> <input checked="" type="checkbox"/> <input checked="" type="checkbox"/> <input checked="" type="checkbox"/> <input checked="" type="checkbox"/>
1080p50	ON	OFF	OFF	ON	OFF	ON <input checked="" type="checkbox"/> <input type="checkbox"/> <input type="checkbox"/> <input type="checkbox"/> <input type="checkbox"/> <input type="checkbox"/> <input type="checkbox"/> <input type="checkbox"/> OFF <input type="checkbox"/> <input checked="" type="checkbox"/> <input checked="" type="checkbox"/> <input checked="" type="checkbox"/> <input checked="" type="checkbox"/> <input checked="" type="checkbox"/> <input checked="" type="checkbox"/> <input checked="" type="checkbox"/>
1080p59.94	ON	OFF	OFF	ON	ON	ON <input checked="" type="checkbox"/> <input type="checkbox"/> <input type="checkbox"/> <input type="checkbox"/> <input type="checkbox"/> <input type="checkbox"/> <input type="checkbox"/> <input type="checkbox"/> OFF <input type="checkbox"/> <input checked="" type="checkbox"/> <input checked="" type="checkbox"/> <input checked="" type="checkbox"/> <input checked="" type="checkbox"/> <input checked="" type="checkbox"/> <input checked="" type="checkbox"/> <input checked="" type="checkbox"/>
1080p60	ON	OFF	ON	OFF	OFF	ON <input checked="" type="checkbox"/> <input type="checkbox"/> <input type="checkbox"/> <input type="checkbox"/> <input type="checkbox"/> <input type="checkbox"/> <input type="checkbox"/> <input type="checkbox"/> OFF <input type="checkbox"/> <input checked="" type="checkbox"/> <input checked="" type="checkbox"/> <input checked="" type="checkbox"/> <input checked="" type="checkbox"/> <input checked="" type="checkbox"/> <input checked="" type="checkbox"/> <input checked="" type="checkbox"/>

## Converter Setup Utility

The Blackmagic Converters Setup utility can be used to change settings such as aspect ratio, and update your Mini Converter's software. All utility settings are maintained, even when the Mini Converter is switched off. You can access these settings by moving between the 'video,' 'audio,' and 'about' tabs.

The 'about' tab is detailed in the 'changing settings' section in this manual.

The 'video' tab for Mini Converter UpDownCross HD contains the following settings:

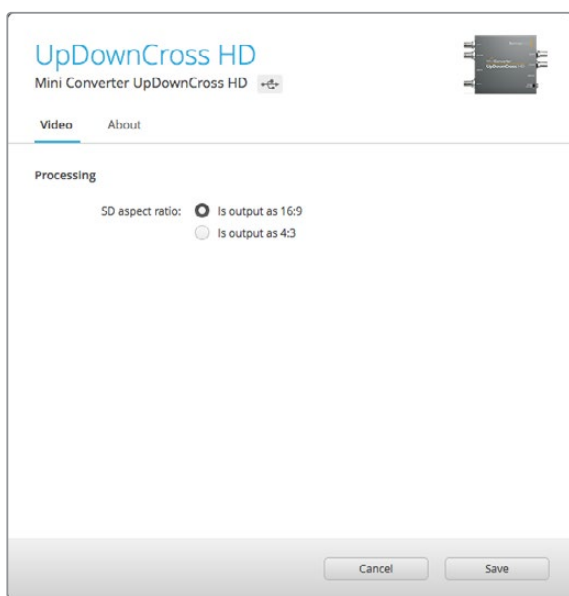

Use the 'video' tab in Converters Setup to select an SD aspect ratio.

### Aspect Ratio for Standard Definition

Select an option for the aspect ratio of the SD output. You can choose 4:3 pillar boxed or 16:9. For example, if your input video is SD 4:3 then selecting 4:3 will output 4:3 pillar boxed to maintain the original 4:3 aspect ratio inside the 16:9 frame. However, if your input video is SD 16:9 select the 16:9 option to output a direct 16:9 conversion.

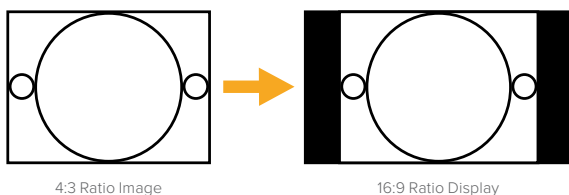

The default aspect ratio setting in the setup utility will output SD video as pillar boxed 4:3, however, you can set the converter to maintain a 16:9 ratio if required by selecting the 16:9 option on the 'video' tab of the setup utility.

# Blackmagic Battery Converters

## Battery Converter SDI to HDMI

With Battery Converter SDI to HDMI you can connect a huge range of HDMI displays and video projectors to SDI based equipment. Your Battery Converter SDI to HDMI automatically detects between SD/HD/3G-SDI and converts to HDMI with embedded audio. Battery Converter SDI to HDMI includes a built in rechargeable battery and recessed connectors protected by an aircraft grade aluminum chassis.

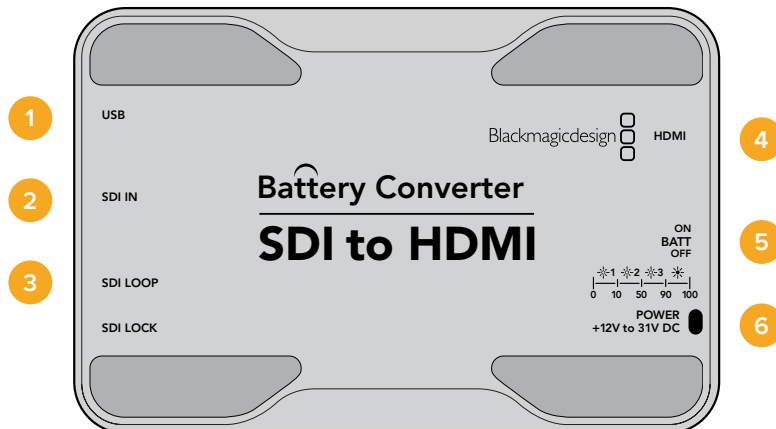

## Connectors

- 1 Mini-B USB port**

Connects to the Blackmagic Converters Setup software via your Mac OS X or Windows computer. The Mini Converter's internal software is also updated using the USB port.
- 2 SDI In**

Primary SDI input BNC connector.
- 3 SDI Loop**

Loop through output of your SDI input BNC connector.
- 4 HDMI**

HDMI type A video output.
- 5 ON BATT OFF**

Switches battery power On or Off. When set to On, the Battery Converter will keep working even if external power is lost. When set to Off, only external power is used to ensure built in battery power is saved. The LED near the switch indicates the battery charge level by a continuous illumination for 100 percent charge, three flashes for 50 to 90 percent charge, two flashes for 10 to 50 percent charge and a single flash if less than 10 percent charge is remaining.
- 6 Power +12V**

12 volt power supply input.

## Battery Converter SDI to HDMI Block Diagram

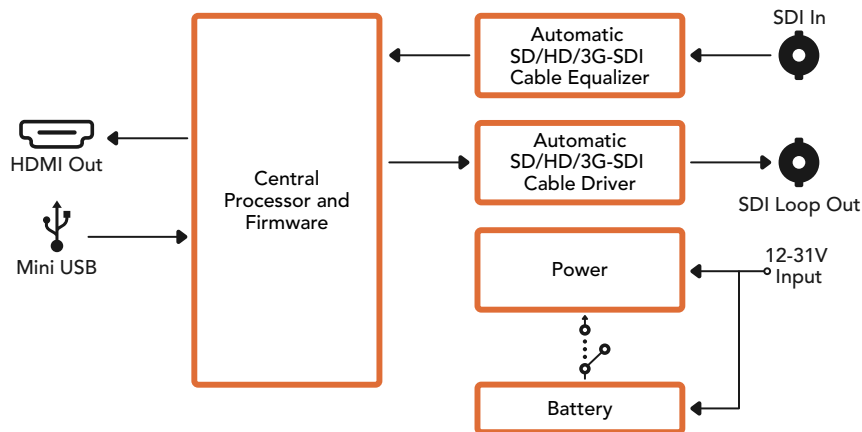

## Battery Converter HDMI to SDI

Your Battery Converter HDMI to SDI can convert HDMI outputs from devices such as HDV cameras and game consoles to SDI. This means you can send video signals from HDMI over SDI using the longest SDI cables. You can even add SDI outputs to computers with HDMI compatibility. Battery Converter HDMI to SDI includes a built in rechargeable battery. Connectors are recessed and protected by an aircraft grade aluminum chassis.

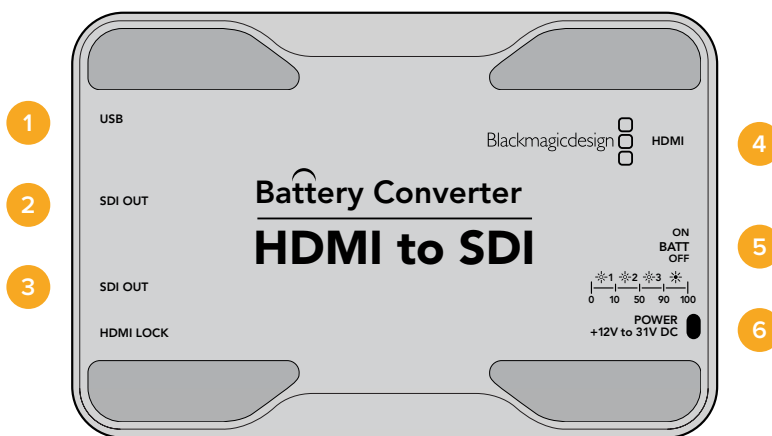

## Connectors

- 1 Mini-B USB port**  
Connects to the Blackmagic Converters Setup software via your Mac OS X or Windows computer. The Mini Converter's internal software is also updated using the USB port.
- 2 SDI OUT**  
SDI video output BNC connector.
- 3 SDI OUT**  
Second SDI output.
- 4 HDMI**  
HDMI type A video input.



**5 ON BATT OFF**

Switches battery power On or Off. When set to On, the Battery Converter will keep working even if external power is lost. When set to Off, only external power is used to ensure built in battery power is saved. The LED near the switch indicates the battery charge level by a continuous illumination for 100 percent charge, three flashes for 50 to 90 percent charge, two flashes for 10 to 50 percent charge and a single flash if less than 10 percent charge is remaining.

**6 Power +12V**

12 volt power supply input.

Battery Converter HDMI to SDI Block Diagram

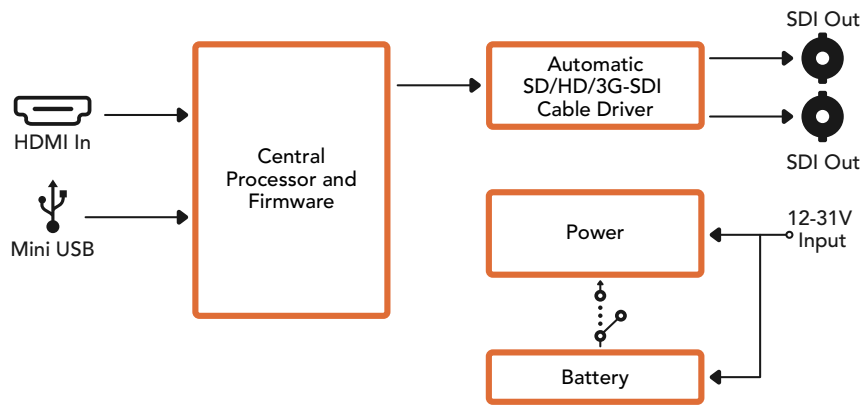

# Help

## Getting Help

The fastest way to obtain help is to go to the Blackmagic Design online support pages and check the latest support material available for your Blackmagic Converter.

### **Blackmagic Design Online Support Pages**

The latest manual, software and support notes can be found at the Blackmagic Design support center at [www.blackmagicdesign.com/support](http://www.blackmagicdesign.com/support).

### **Blackmagic Design Forum**

The Blackmagic Design forum on our website is a helpful resource you can visit for more information and creative ideas. This can also be a faster way of getting help as there may already be answers you can find from other experienced users and Blackmagic Design staff which will keep you moving forward. You can visit the forum at <https://forum.blackmagicdesign.com>

### **Contacting Blackmagic Design Support**

If you can't find the help you need in our support material, or on the forum, please click the "Send us an email" button on the support page to email a support request. Alternatively, click on the "Find your local support team" button and call your nearest Blackmagic Design support office.

### **Checking the Software Version Currently Installed**

To check which version of Converter Setup software is installed on your computer, open the About Blackmagic Converter Setup window.

- On Mac OS X, open Blackmagic Converter Setup from the Applications folder. Select About Blackmagic Converter Setup from the application menu to reveal the version number.
- On Windows, open Blackmagic Converter Setup from your Start menu. Click on the Help menu and select About Blackmagic Converter Setup to reveal the version number.
- On Windows 8, open Blackmagic Converter Setup from the Blackmagic Converter Setup tile on your Start page. Click on the Help menu and select About Blackmagic Converter Setup to reveal the version number.

### **How to Get the Latest Software Updates**

After checking the version of Blackmagic Converters Setup software installed on your computer, please visit

the Blackmagic Design support center at [www.blackmagicdesign.com/support](http://www.blackmagicdesign.com/support) to check for the latest updates. While it is usually a good idea to run the latest updates, it is wise to avoid updating any software if you are in the middle of an important project.

# Warranty

## Limited Warranty

Blackmagic Design warrants that Mini Converters and Mini Converters Heavy Duty will be free from defects in materials and workmanship for a period of 36 months from the date of purchase excluding connectors, cables, fiber optic modules, fuses and batteries which will be free from defects in materials and workmanship for a period of 12 months from the date of purchase. Blackmagic Design warrants that Battery Converters will be free from defects in materials and workmanship for a period of 12 months from the date of purchase. If a product proves to be defective during this warranty period, Blackmagic Design, at its option, either will repair the defective product without charge for parts and labor, or will provide a replacement in exchange for the defective product.

In order to obtain service under this warranty, you the Customer, must notify Blackmagic Design of the defect before the expiration of the warranty period and make suitable arrangements for the performance of service. The Customer shall be responsible for packaging and shipping the defective product to a designated service center nominated by Blackmagic Design, with shipping charges pre paid. Customer shall be responsible for paying all shipping charges, insurance, duties, taxes, and any other charges for products returned to us for any reason.

This warranty shall not apply to any defect, failure or damage caused by improper use or improper or inadequate maintenance and care. Blackmagic Design shall not be obligated to furnish service under this warranty: a) to repair damage resulting from attempts by personnel other than Blackmagic Design representatives to install, repair or service the product, b) to repair damage resulting from improper use or connection to incompatible equipment, c) to repair any damage or malfunction caused by the use of non Blackmagic Design parts or supplies, or d) to service a product that has been modified or integrated with other products when the effect of such a modification or integration increases the time or difficulty of servicing the product. THIS WARRANTY IS GIVEN BY BLACKMAGIC DESIGN IN LIEU OF ANY OTHER WARRANTIES, EXPRESS OR IMPLIED. BLACKMAGIC DESIGN AND ITS VENDORS DISCLAIM ANY IMPLIED WARRANTIES OF MERCHANTABILITY OR FITNESS FOR A PARTICULAR PURPOSE. BLACKMAGIC DESIGN'S RESPONSIBILITY TO REPAIR OR REPLACE DEFECTIVE PRODUCTS IS THE WHOLE AND EXCLUSIVE REMEDY PROVIDED TO THE CUSTOMER FOR ANY INDIRECT, SPECIAL, INCIDENTAL OR CONSEQUENTIAL DAMAGES IRRESPECTIVE OF WHETHER BLACKMAGIC DESIGN OR THE VENDOR HAS ADVANCE NOTICE OF THE POSSIBILITY OF SUCH DAMAGES. BLACKMAGIC DESIGN IS NOT LIABLE FOR ANY ILLEGAL USE OF EQUIPMENT BY CUSTOMER. BLACKMAGIC IS NOT LIABLE FOR ANY DAMAGES RESULTING FROM USE OF THIS PRODUCT. USER OPERATES THIS PRODUCT AT OWN RISK.

© Copyright 2018 Blackmagic Design. All rights reserved. 'Blackmagic Design', 'DeckLink', 'HDLINK', 'Workgroup Videohub', 'Multibrige Pro', 'Multibrige Extreme', 'Intensity' and 'Leading the creative video revolution' are registered trademarks in the US and other countries. All other company and product names may be trade marks of their respective companies with which they are associated.