

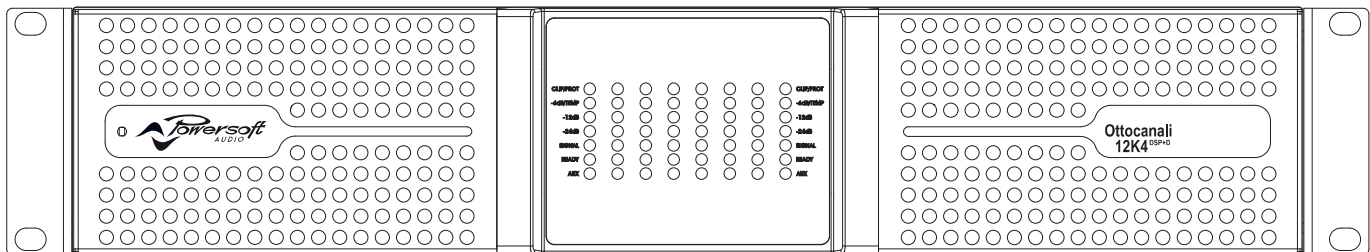

Ottocanali Series



Quick Guide

Ottocanali 12K4
Ottocanali 12K4 DSP+D

Ottocanali 8K4
Ottocanali 8K4 DSP+D

Ottocanali 4K4
Ottocanali 4K4 DSP+D

DO000202.04_Powersoft_Ottocanali_QG_en

Data are subject to change without notice.
For latest update please refer to the English
online version available on www.powersoft-audio.com.

Table of contents

1.Important safety instructions	10
2.Ottocanali Series	11
2:1.Welcome	11
2:2.Unpacking & checking for shipping damage	11
2:3.Disposal of the packaging material	11
2:4.List of image panels	11
3.Installation	12
3:1.Location	12
3:2.Cooling	12
3:3.Cleaning	12
3:4.AC mains supply	12
3:5.Energy save	13
3:6.Remote ON/OFF (standby mode)	13
3:7.Precautions regarding installation	13
4.Connections	14
4:1.Signal grounding	14
4:2.Analog audio input connections	14
4:2.1.AUX SEL. IN: Analog input selection	14
4:2.2.PWS OUT: Built-in auxiliary power supply	14
4:3.Digital audio input connections	14
4:3.1.Input selection and Backup policy	14
4:4.Ethernet connections	14
4:5.Output connections	15
4:5.1.Hi-Z 70V/100V operations	15
4:6.GPO - Alarms	15
4:6.1.Pilot tone monitoring	15
4:6.2.Output load monitoring	15
5.Attenuators	16
6.LED chart	16
7.Firmware update	16
8.Networking	17
8:1.IP addressing	17
8:1.1.IP Addressing troubleshooting	17
8:2.Dante™ networking	17
8:2.1.Redundant network configuration	17
9.Armonía Pro Audio Suite	18
9:1.Signal routing and DSP architecture	18
9:2.Purposed workflow	18
10.Warranty and assistance	19
10:1.Warranty	19
10:1.1.Return of Goods	19
10:1.3.Repair or replacement	19
10:1.4.Cost and responsibility of transport	19
10:2.Assistance	19

A

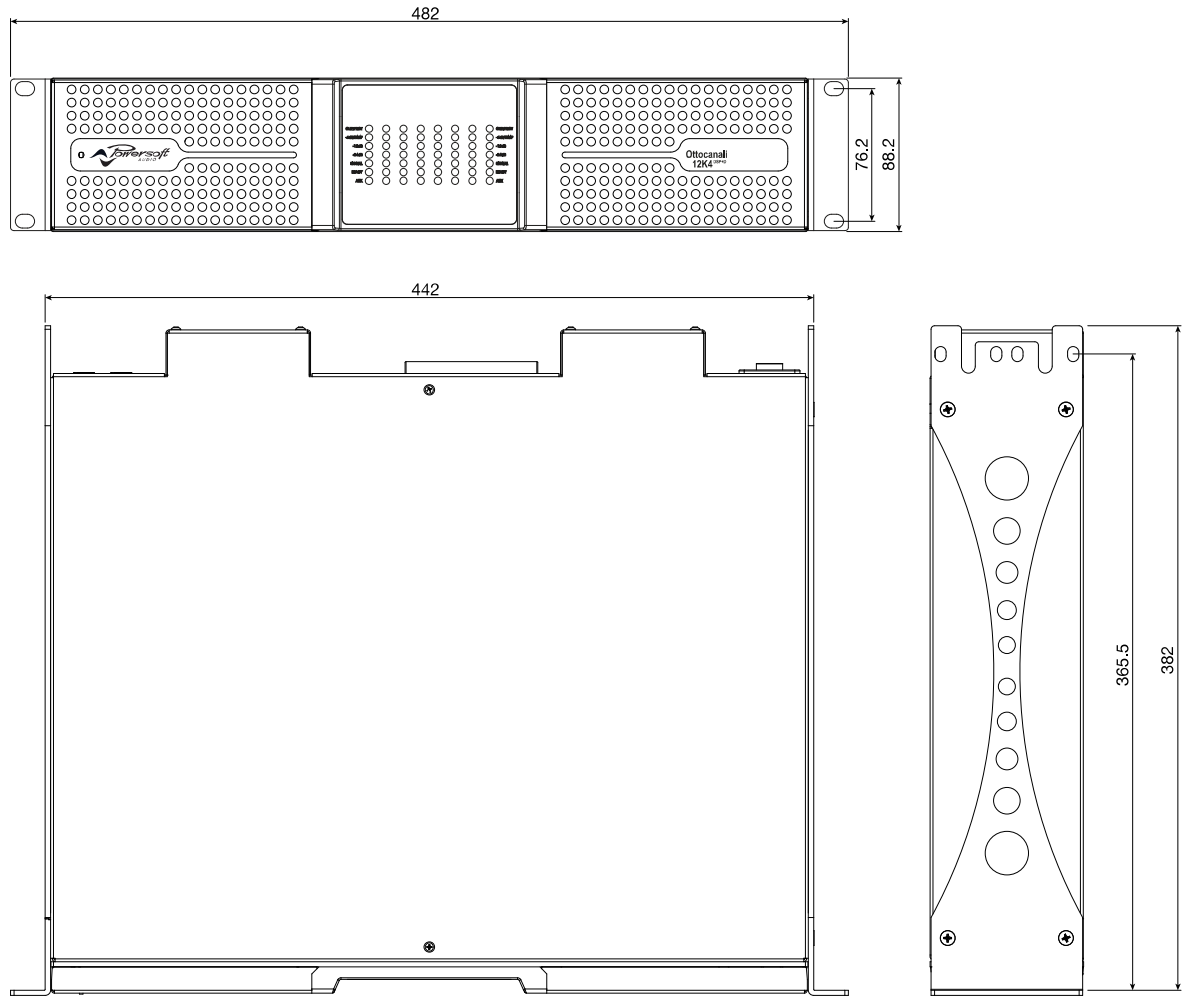

B

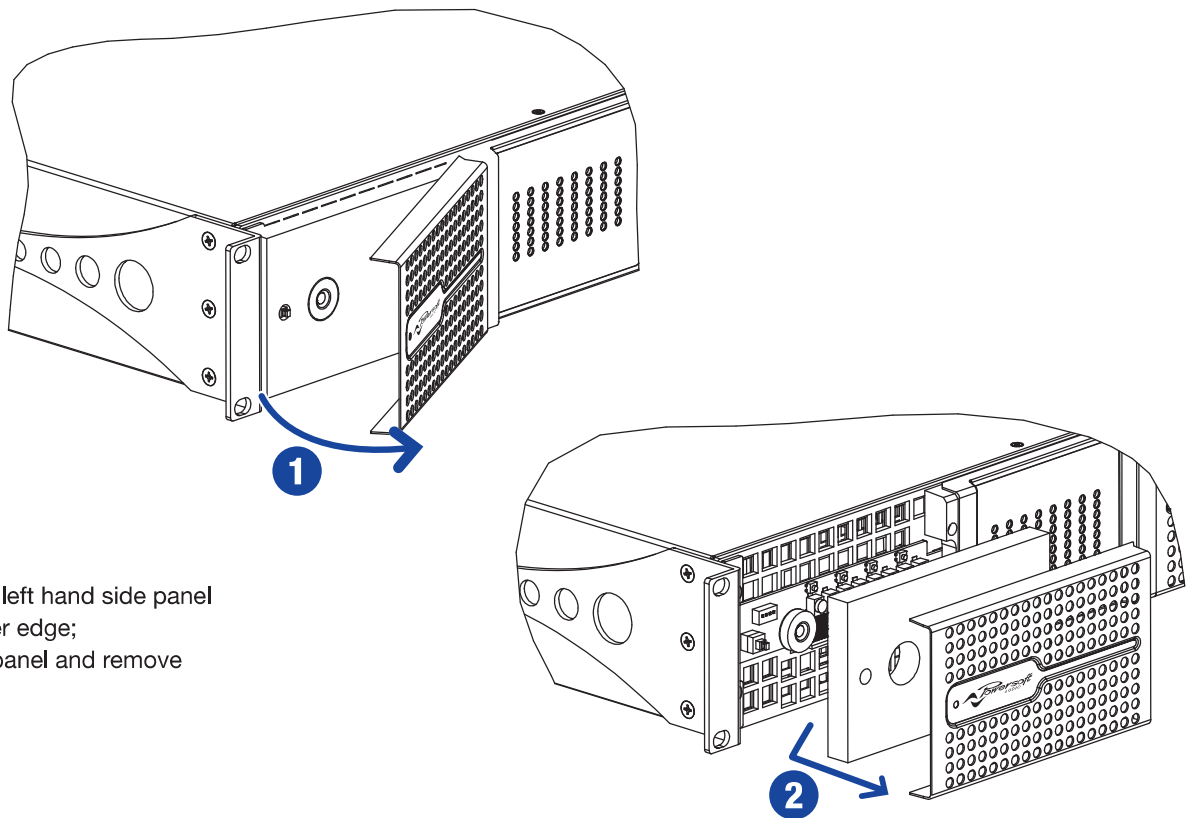

1. Grip the outermost left hand side panel and tilt it on its inner edge;
2. Carefully slide the panel and remove the anti-dust filter.

Ottocanali 12K4
Ottocanali 8K4
Ottocanali 4K4

C

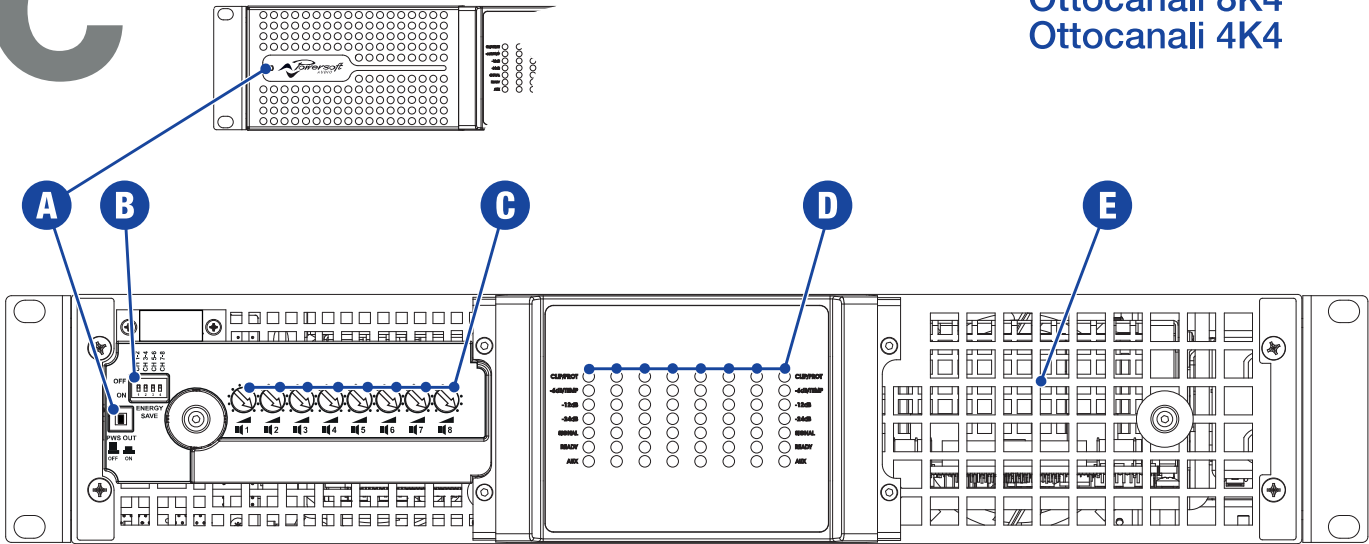

Front

- A. 24 V_{DC} PWS OUT switch
- B. Energy save DIP switches
- C. Input attenuators (channels 1 to 8)
- D. Multifunction LEDs (channels 1 to 8)
- E. Air vent

D

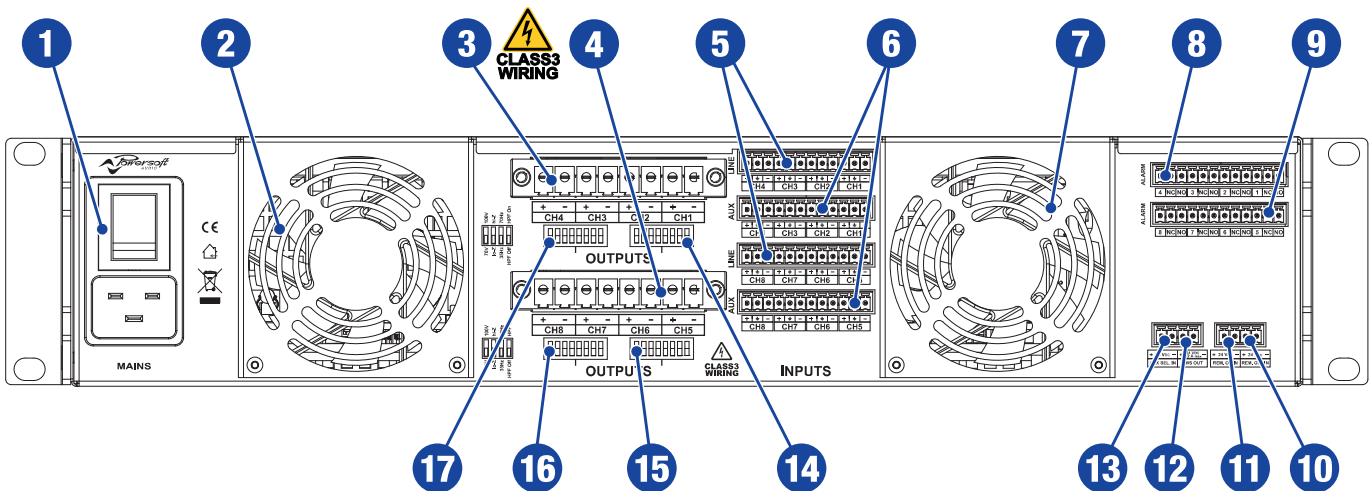

Rear

- 1. On/off power switch and AC mains IEC C20 inlet
- 2. Fan
- 3. Audio outputs (channels 1-4)
- 4. Audio outputs (channels 5-8)
- 5. Audio inputs: LINE (ch. 1-8)
- 6. Audio inputs: AUX (ch. 1-8)
- 7. Fan
- 8. GPO - Alarms channels 1-4
- 9. GPO - Alarms channels 5-8
- 10. Remote off switch
- 11. Disabled (remote on) switch
- 12. 24 V_{DC} PWS OUT
- 13. AUX SEL. IN input selector
- 14. Multi function DIP switch ch. 1-2 (impedance, voltage, filter)
- 15. Multi function DIP switch ch. 5-6 (impedance, voltage, filter)
- 16. Multi function DIP switch ch. 7-8 (impedance, voltage, filter)
- 17. Multi function DIP switch ch. 3-4 (impedance, voltage, filter)

Ottocanali 12K4 DSP+D
 Ottocanali 8K4 DSP+D
 Ottocanali 4K4 DSP+D

E

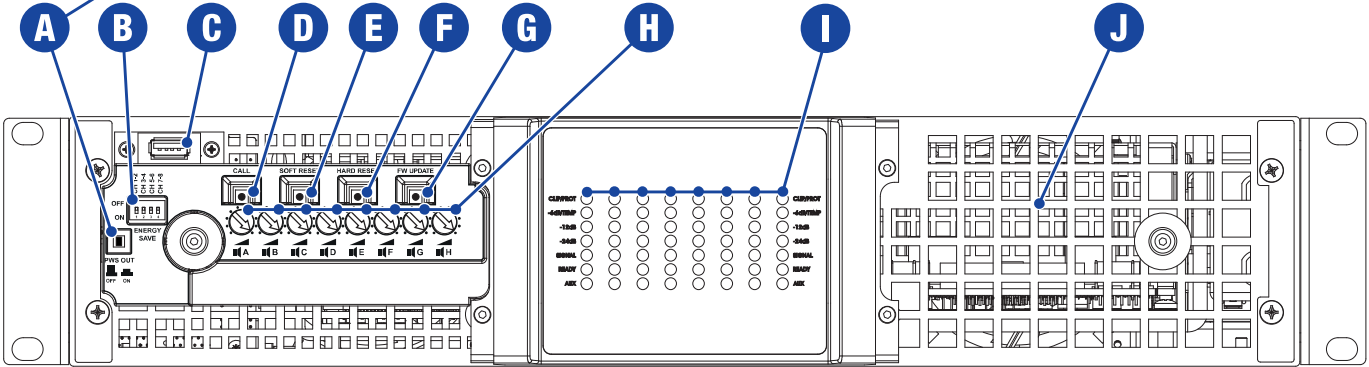
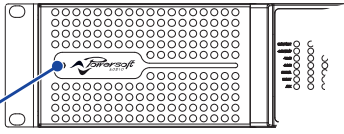

Front

- A. 24 V_{DC} PWS OUT switch
- B. Energy save DIP switches
- C. USB port
- D. Callback to Armonia
- E. Soft reset pushbutton
- F. Hard reset pushbutton
- G. Firmware update pushbutton
- H. Output attenuators (speakers A to H)
- I. Multifunction LEDs (channels 1 to 8)
- J. Air vent

F

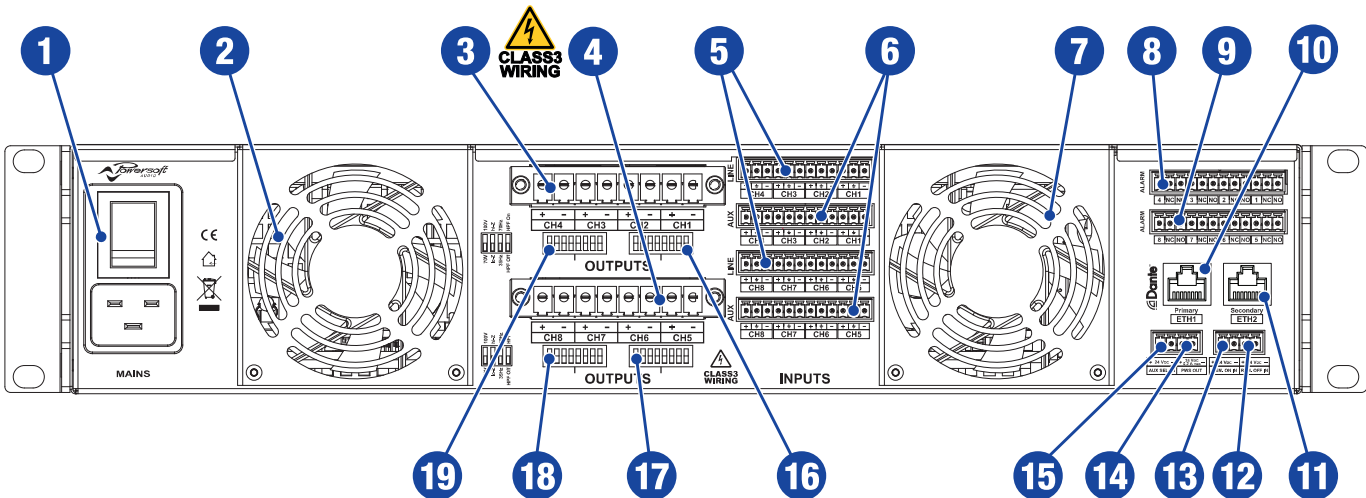

Rear

- 1. On/off power switch and AC mains IEC C20 inlet
- 2. Fan
- 3. Audio outputs (channels 1-4)
- 4. Audio outputs (channels 5-8)
- 5. Audio inputs: LINE (ch. 1-8)
- 6. Audio inputs: AUX (ch. 1-8)
- 7. Fan
- 8. GPO - Alarms channels 1-4
- 9. GPO - Alarms channels 5-8
- 10. Ethernet port/Dante™ primary
- 11. Ethernet port/Dante™ secondary
- 12. Remote off switch
- 13. Remote on switch
- 14. 24 V_{DC} PWS OUT
- 15. AUX SEL. IN input selector
- 16. Multi function DIP switch ch. 1-2 (impedance, voltage, filter)
- 17. Multi function DIP switch ch. 5-6 (impedance, voltage, filter)
- 18. Multi function DIP switch ch. 7-8 (impedance, voltage, filter)
- 19. Multi function DIP switch ch. 3-4 (impedance, voltage, filter)

G

INPUT

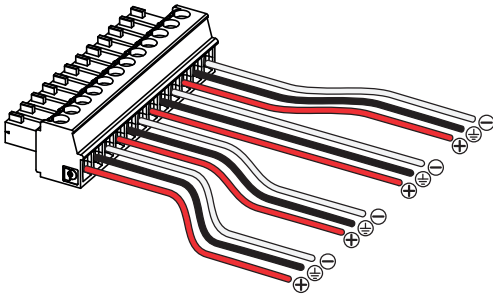

Phoenix MC 1,5/12-ST-3,81 1803675

H

OUTPUT (single ended)

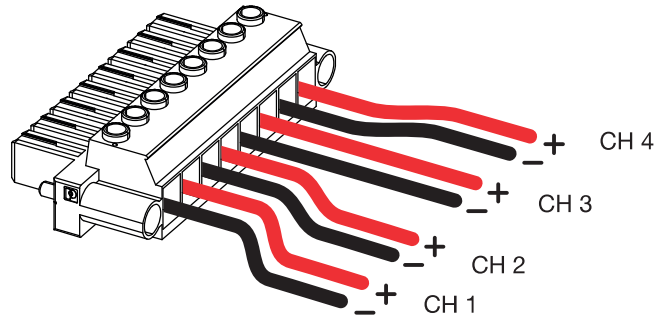

Phoenix PC 5/ 8-STF1-7,62 1777891

I

GPO

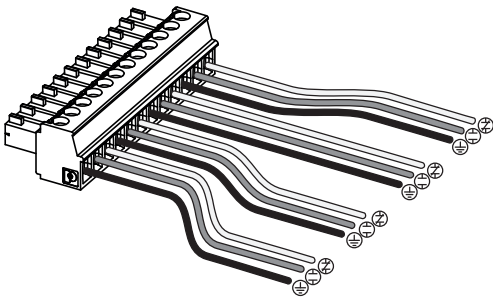

Phoenix MC 1,5/12-ST-3,81 1803675

J

INPUT (link channel pairs)

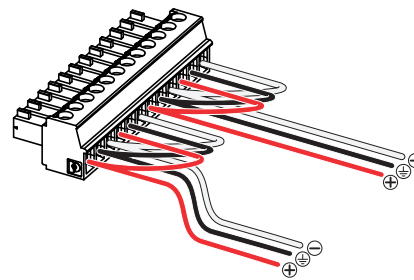

Phoenix MC 1,5/12-ST-3,81 1803675

Bill of connectors

Name	Plug
INPUT	Phoenix MC 1,5/12-ST-3,81 1803675
OUTPUT	Phoenix PC 5/ 8-STF1-7,62 1777891
GPO/ALARM	Phoenix MC 1,5/12-ST-3,81 1803675
AUXILIARY	Phoenix MC 1,5/4-ST-3,81 1803594
AC MAINS	IEC C19

OUTPUT (bridged)

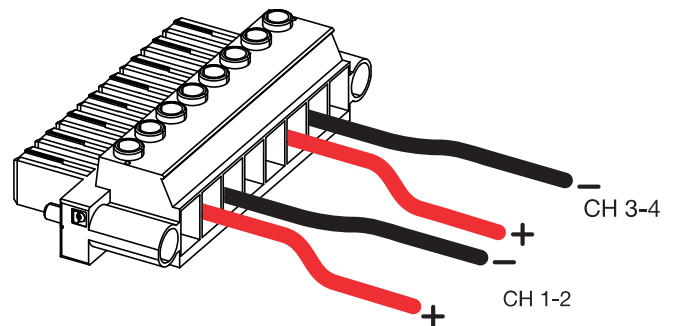

Phoenix PC 5/ 8-STF1-7,62 1777891

K

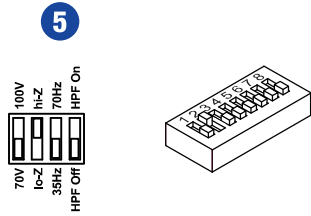
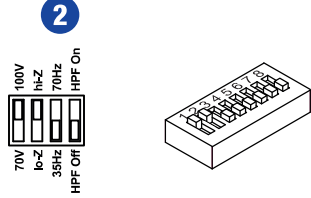
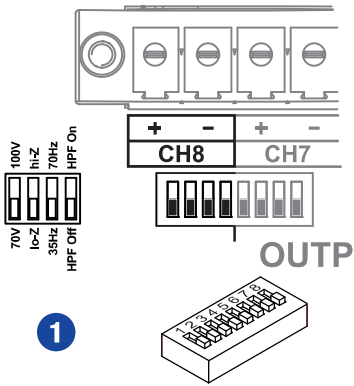

	Low-Z	High-Z	100V	70V	HPF @ 35 Hz	HPF @ 70 Hz
1	•					
2		•	•			
3		•	•		•	
4		•	•			•
5		•		•		
6		•		•	•	
7		•		•		•

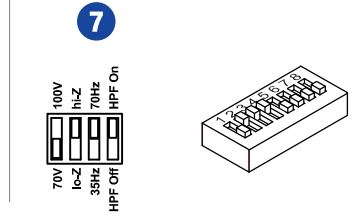
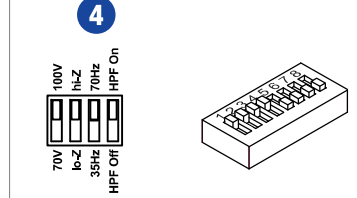
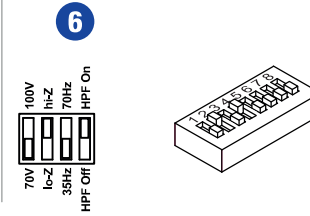
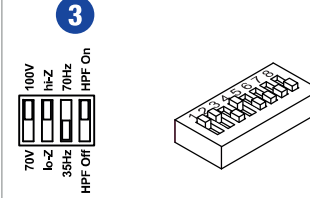

L

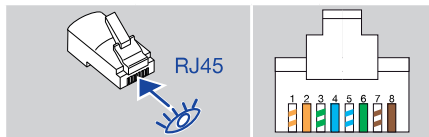

Color code (TIA/EIA-568-B)

Pin

	ORANGE / WHITE	1
	ORANGE	2
	GREEN / WHITE	3
	BLUE	4
	BLUE / WHITE	5
	GREEN	6
	BROWN / WHITE	7
	BROWN	8

M

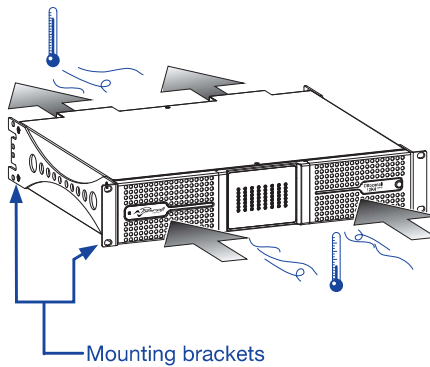

N

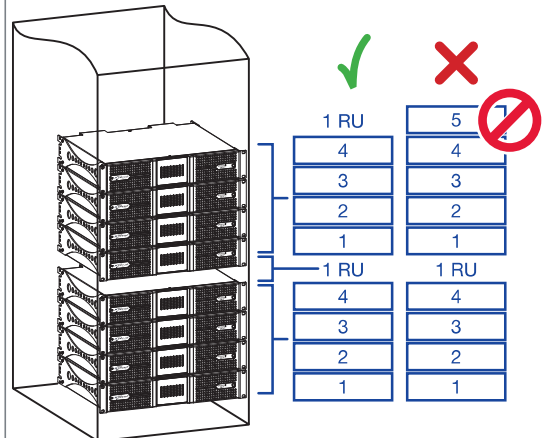

Regulatory informations



WEEE Directive

If the time arises to throw away your product, please recycle all possible component.



This symbol indicates that when the end-user wishes to discard this product, it must be sent to separate collection facilities for recovery and recycling. By separating this product from other household-type waste, the volume of waste sent to incinerators or land-fills will be reduced and natural resources will thus be conserved.

The Waste Electrical and Electronic Equipment Directive (WEEE Directive) aims to minimise the impact of electrical and electronic goods on the environment. Powersoft S.p.A. comply with the Directive 2012/19/EU of the European Parliament on waste electrical and electronic equipment (WEEE) in order to reduce the amount of WEEE that is being disposed of in land-fill site.

All of our products are marked with the WEEE symbol; this indicates that this product must NOT be disposed of with other waste. Instead it is the user's responsibility to dispose of their waste electrical and electronic equipment by handing it over to an approved reprocessor, or by returning it to Powersoft S.p.A. for reprocessing. For more information about where you can send your waste equipment for recycling, please contact Powersoft S.p.a. or one of your local distributors.

EC Declaration Of Conformity

Manufacturer:
Powersoft S.p.A.
via E. Conti 5
50018 Scandicci (Fi)
Italy



We declare that under our sole responsibility the products:

Model Names: Ottocanali 12K4
Ottocanali 12K4 DSP+D,
Ottocanali 8K4
Ottocanali 8K4 DSP+D
Ottocanali 4K4
Ottocanali 4K4 DSP+D

Intended use: Professional Audio Amplifier

Are in conformity with the provisions of the following EC Directives, including all amendments, and with national legislation implementing these directives:

2014/35/EU	Low Voltage Directive
2014/30/EU	Electromagnetic Compatibility Directive
2011/65/EU	RoHs Directive
2014/53/EU	Radio Equipment Directive

The following harmonized standards are applied:

EN 55103-1: 2009 /A1: 2012
EN 55103-2: 2009 /IS: 2012
EN 60065: 2014 /AC: 2016

Scandicci,
February 2017

Luca Lastrucci
Managing Director

For compliance questions only: compliance@powersoft.it

Important safety instructions

1

EXPLANATIONS OF GRAPHICAL SYMBOLS

 The triangle with the lightning bolt is used to alert the user to the risk of electric shock.

 The triangle with the exclamation point is used to alert the user to important operating or maintenance instructions.

 The CE-mark indicates the compliance with the low voltage and electromagnetic compatibility.

 Symbol for earth/ground connection.

 Symbol indicating that the equipment is for indoor use only.

 Symbol for conformity with Directive 2002/96/EC and Directive 2003/108/EC of the European Parliament on waste electrical and electronic equipment (WEEE).

 Do not use the unit at altitudes above 2000 m.

 Do not use the unit in tropical environment.

 WARNING: TO REDUCE THE RISK OF ELECTRIC SHOCK, DO NOT ATTEMPT TO OPEN ANY PART OF THE UNIT. NO USER-SERVICEABLE PARTS INSIDE. REFER SERVICING TO QUALIFIED SERVICE PERSONNEL.

 TO COMPLETELY DISCONNECT THIS APPARATUS FROM THE AC MAINS, DISCONNECT THE POWER SUPPLY CORD PLUG FROM THE AC RECEPTACLE.

 THE MAINS PLUG OF THE POWER SUPPLY CORD MUST REMAIN READILY ACCESSIBLE.

 DO NOT EXPOSE THIS EQUIPMENT TO RAIN OR MOISTURE, DRIPPING OR SPLASHING LIQUIDS. OBJECTS FILLED WITH LIQUIDS, SUCH AS VASES, SHOULD NOT BE PLACED ON THIS APPARATUS.

 THE UNIT MUST BE INSTALLED IN RACK CABINETS: INSTEAD OF CONNECTING THE AMPLIFIER TO THE POWER GRID DIRECTLY, PLUG THE AMPLIFIER'S MAINS CONNECTIONS VIA A SECTIONING BREAKER TO A POWER DISTRIBUTION PANEL INSIDE THE RACK CABINET.

 WHEN THE UNIT IS INSTALLED IN A CABINET OR A SHELF, MAKE SURE THAT IT HAS SUFFICIENT SPACE ON ALL SIDES TO ALLOW FOR PROPER VENTILATION (50 CM FROM THE FRONT AND REAR VENTILATION OPENINGS).

 CONNECTION TO THE MAINS SHALL BE DONE ONLY BY A ELECTROTECHNICAL SKILLED PERSON ACCORDING THE NATIONAL REQUIREMENTS OF THE COUNTRIES WHERE THE UNIT IS SOLD.

 WARNING. THIS APPARATUS CONTAINS A NON RECHARGEABLE LITHIUM BATTERY (I.E. CR2032, 3V). THE BATTERY IS NOT INTENDED TO BE REPLACED BY THE END USER. ONLY THE STAFF OF THE AUTHORIZED SERVICE CENTERS CAN ACCESS AND REPLACE THE BATTERY.

 WARNING: THE INTERNAL BATTERY SHALL NOT BE EXPOSED TO EXCESSIVE HEAT SUCH AS SUNSHINE, FIRE OR THE LIKE.



Electrical energy can perform many useful functions. This unit has been engineered and manufactured to ensure your personal safety. But **IMPROPER USE CAN RESULT IN POTENTIAL ELECTRICAL SHOCK OR FIRE HAZARD.**

In order not to defeat the safeguards incorporated into this product, observe the following basic rules for its installation, use and service. Please read these "Important Safeguards" carefully before use.

Important safety instructions

1. Read these instructions.
2. Keep these instructions.
3. Heed all warnings.
4. Follow all instructions.
5. Do not use this equipment near water.
6. Clean only with a dry cloth.
7. Do not block any ventilation openings. Install in accordance with the manufacturer's instructions.
8. Do not install near any heat sources such as radiators, heat registers, stoves, or other apparatus (including amplifiers) that produce heat.
9. Do not defeat the safety purpose of the polarized or grounding-type plug. A polarized plug has two blades with one wider than the other. A grounding type plug has two blades and a third grounding prong. The wide blade or the third prong are provided for your safety. If the provided plug does not fit into your outlet, consult an electrician for replacement of the obsolete outlet.
10. Protect the power cord from being walked on or pinched particularly at plugs, convenience receptacles, and the point where they exit from the apparatus.
11. Only use attachments/accessories specified by the manufacturer.
12. Use only with the cart, stand, tripod, bracket, or table specified by the manufacturer, or sold with the apparatus. When a cart is used, use caution when moving the cart/apparatus combination to avoid injury from tip-over. 
13. Unplug this apparatus during lightning storms or when unused for long periods of time.
14. Refer all servicing to qualified service personnel. Servicing is required when the apparatus has been damaged in any way, such as power-supply cord or plug is damaged, liquid has been spilled or objects have fallen into the apparatus, the apparatus has been exposed to rain or moisture, does not operate normally, or has been dropped.

2:1.Welcome

Congratulations on buying a Powersoft Ottocanali Series amplifier!

We know you are eager to use your new Ottocanali amplifier, but please take a moment to read this quick guide and the safety instructions. In case you have any questions, please do not hesitate to contact your dealer or Powersoft.

The Ottocanali Series is specifically designed for installation applications. Ottocanali Series offers smaller dimensions, lighter weight and the traditionally amazing sound quality and reliability of all Powersoft products.

The built in PFC (Power Factor Correction) allows flawless worldwide operation with any AC mains voltage, from 100 to 240V; patented SRM (Smart Rails Management) technology allows to maximize the efficiency of the system and drastically reduce power consumption at any load and usage condition. This system automatically alters the rails working voltage according to the instantaneous power requirements of the system. A low output power requires a lower rails voltage which in turn yields lower power consumption while at the same time guaranteeing lightning fast switching to full rails voltage when the system requires full power.

Ottocanali Series implements redundant power supplies for maximum reliability even in case of system fault. In case of damages in one power supply, the other one is capable to maintain the system up, guaranteeing non-stop functionality even in harsh conditions.

Ottocanali Series is designed to work with lo-Z (from 2Ω) and with 70V/100V distributed lines: any mixed configuration of low and high impedance output loads can be realized, making the Ottocanali Series suitable to all application in installed sound reinforcement systems.

Ottocanali Series encompasses three models:

- ▶ Ottocanali 12K4 delivering up to 1500 W per channel at 4Ω
- ▶ Ottocanali 8K4 delivering up to 1000 W per channel at 4Ω
- ▶ Ottocanali 4K4 delivering up to 500 W per channel at 4Ω

Each model is available in three versions: normal, with DSP plus Dante™ and with DSP plus Ethernet connectivity.

2:2.Unpacking & checking for shipping damage

Your Powersoft product has been completely tested and inspected before leaving the factory. Carefully inspect the shipping package before opening it, and then immediately inspect your new product. If you find any damage notify the shipping company or reseller immediately.

The box contains the following:

- ▶ 1x Ottocanali Series amplifier.
- ▶ 2x Phoenix MC 1,5/ 4-ST-3,81 - 1803594 plug
- ▶ 6x Phoenix MC 1,5/12-ST-3,81 - 1803675 plug
- ▶ 2x Phoenix PC 5/ 8-STF1-7,62 - 1777891 plug
- ▶ 1x IEC power cord
- ▶ 1x user guide

2:3.Disposal of the packaging material

The protective transport packaging has been selected from materials which are environmentally friendly for disposal and can normally be recycled.

Rather than just throwing these materials away, please ensure they are offered for recycling.

2:4.List of image panels

- A. Mechanical drawings: all dimensions in millimeters
- B. Front panel: how to access it
- C. Ottocanali Series: Front panel description
- D. Ottocanali Series: Rear panel description
- E. Ottocanali Series DSP: Front panel description
- F. Ottocanali Series DSP: Rear panel description
- G. Input connector: wiring (single ended mode)
- H. Output connector: wiring (single ended mode)
- I. Alarms connector: wiring
- J. Input/Output connectors: wiring (bridged mode)
- K. Output load DIP switch configurations
- L. RJ45 Ethernet wiring (Color code TIA/EIA-568-B)
- M. Air flow and mounting brackets
- N. Rack mounting constraints
- O. Regulatory information

Installation

3

3:1.Location

Ottocanali Series amplifiers are meant to be installed into rack. In order to limit the risk of mechanical damages, the amplifiers must be fixed to the rack using both frontal and rear mounting brackets. We recommend to use eight M6 or 12-24 UNC-2B screws for threaded holes or cage nuts.

The AC mains connection of the units should be connected to a proper circuit breaker (refer to [§3:4.AC mains supply](#) for more details).

Install this amplifier as far as possible from radio tuners and TV sets. An amplifier installed in close proximity of such equipment may experience noise or generic performance degradation. Placing and using the amplifier for long periods of time on heat generating sources will affect its performance. Avoid placing the amplifier on heat generating sources.

3:2.Cooling

Install the amplifier in a well-ventilated location: the ventilation openings must not be impeded by any item such as newspapers, tablecloths, curtains, etc; keep a distance of at least 50 cm from the front and rear ventilation openings of the amplifier.

All Powersoft amplifiers implement a forced-air cooling system to maintain low and constant operating temperatures. Drawn by the internal fans, air enters from the front panel and is forced over all components, exiting at the back of the amplifier.

The amplifier's cooling system features "intelligent" variable-speed DC fans which are controlled by the heatsink temperature sensing circuits: the fans speed will increase only when the temperature detected by the sensors rises over carefully predetermined values. This ensures that fan noise and internal dust accumulation are kept to a strict minimum.

Should however the amplifier be subject to an extreme thermal load, the fan will force a very large volume of air through the heat sink. In the extremely rare event that the amplifier should dangerously overheat, sensing circuits shut down all channels until the amplifier cools down to a safe operating temperature. Normal operation is resumed automatically without the need for user intervention.

Ottocanali Series amplifiers can be stacked one on top of the other due to the efficient cooling system they are equipped with.

There is however a safety limit to be observed: in case a rack with closed back panels is used, leave one rack unit empty every four installed amplifiers to guarantee adequate air flow (see [Panel N, p. 14](#)).

3:3.Cleaning

Always use a dry cloth for cleaning the chassis and the front panel. Air filter cleaning should be scheduled according to the dust levels in the amplifier's operating environment.

 **Disconnect the AC mains source before attempting to clean any part of the amplifier** 

In order to clean the vent filters you need to remove the front cover: never attempt to open any other part of the unit.

1. Firmly grip the outermost silver colored panel and pull outwards at an angle, as if opening a door (see [Panel B, p. 7](#)).
2. Carefully slide the metal panel away from the chassis. When the front panel is removed, the air filter (looking like a shiny black plastic sponge) will be exposed.

You may use compressed air to remove the dust from filters, or wash it with clean water: in the latter case ensure that the filter is dry before reassembly.

3:4.AC mains supply

Ottocanali Series amplifiers implement two universal redundant switching mode power supplies operating in the range from 100 V_{AC} up to 240 V_{AC} ±10%.

AC mains connection is in the rear panel through the IEC C20 inlet with power switch: the approved power cord is provided (see [FIG. 1](#)).

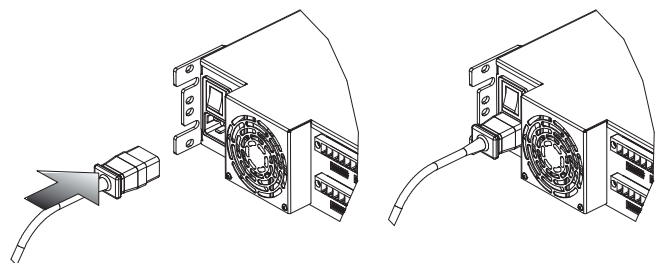





FIG. 1: AC mains connection.

 **AC mains connections must be performed only by professional or qualified personnel according to local electrical authorities guidelines.** 

 **This device must be powered exclusively by earth connected mains sockets in electrical networks compliant to the IEC 364 or similar rules.** 

 **Powersoft suggests to plug the Ottocanali to a 32 A rating, C or D curve, 10 kA sectioning breaker.** 

3:5. Energy save

Energy save capabilities can be activated for each channel pair. Four DIP switches are located on the left hand side of the front panel (see [Panel C, p. 8](#) and [Panel E, p. 10](#)): in order to activate the Energy save mode for channel pair set the switches in the bottom position.

When the Energy save mode is activate on a channel pair, the Ottocanali enters a low power consumption idle state when no signal activity is detected for more than 4 seconds. Normal operation is resumed in a matter of milliseconds when an incoming signal is detected on the channel pair.

[TAB. 1](#) shows the power consumption in idle mode for non-DSP amplifiers, when the Energy save is either enabled or disabled on all channels.

Energy Save	115 V _{AC} mains			230 V _{AC} mains		
	Current	Real Power	Apparent Power	Current	Real Power	Apparent Power
ON	0.65 A	30 W	75 VA	0.76 A	35 W	175 VA
OFF	0.90 A	52 W	103.5 VA	0.84 A	58 W	193 VA

TAB. 1: Idle consumption.

Note: in caswe a pilot tone is used for checking system integrity and line faults, the Ottocanali amplifier would continuously detects a stationary signal that prevents the the idle mode. In this condition the Energy save will never activate.

3:6. Remote ON/OFF (standby mode)

Remote ON/OFF is available through the proper terminals in the rear panel: in non-DSP Ottocanali (see [Panel D, p. 8](#)) by switching 24V_{DC} ±10% voltage (10 mA max) applied to the REM OFF connector, the amplifier can be remotely toggle between standard operating and the standby modes.

- ▶ When a 24 V_{DC} voltage is applied to REM OFF, the amplifier switches to standby mode.
- ▶ When the 24 V_{DC} voltage is removed from REM OFF, the amplifier switches back on as per normal boot up operation.

In order to remotely toggle between standard operating and the standby modes, the AC mains power must be active and the mains button switched on.

3:7. Precautions regarding installation

WARNING: TO PREVENT FIRE OR ELECTRIC SHOCK

- ▶ This device must be powered exclusively by earth connected mains sockets in electrical networks compliant to the IEC 364 or similar rules.
 - ▶ Install the unit into rack cabinet.
 - ▶ A sectioning breaker between the mains connections and the amplifier should be installed inside the rack cabinet.
 - ▶ Properly fit the AC mains plug to the amplifier inlet.
 - ▶ Before powering this amplifier, verify that the correct voltage rating is being used.
 - ▶ Verify that your mains connection is capable of satisfying the power ratings of the device.
 - ▶ Do not use this amplifier if the electrical power cord is frayed or broken.
 - ▶ Output terminals are hazardous: wiring connection to these terminals require installation by an instructed person and the use of ready-made leads.
 - ▶ Take care to lock the output terminal before switching the device on.
 - ▶ To avoid electrical shock, do not touch any exposed speaker wiring while the amplifier is operating.
 - ▶ Do not spill water or other liquids into or on the amplifier.
 - ▶ No naked flame sources such as lighted candles should be placed on the amplifier.
 - ▶ Do not remove the cover. Failing to do so will expose you to potentially dangerous voltage.
 - ▶ The manufacturer cannot be held responsible for damages caused to persons, things or data due to an improper or missing ground connection.
 - ▶ Contact the authorized service center for ordinary and extra-ordinary maintenance.
- It is absolutely necessary to verify these fundamental requirement of safety and, in case of doubt, require an accurate check by qualified personnel.**

Connections

Make sure the power switch is off before attempting to make any input or output connections.

By using good quality input and speaker cables, the likelihood of erratic signal behavior is reduced to a minimum. Whether you make them or buy them, look for good quality wires, connectors and soldering techniques.

4:1.Signal grounding

There is no ground switch or terminal on the Ottocanali Series amplifiers. All shield terminals of input connections are directly connected to the chassis. This means that the unit's signal grounding system is automatic. In order to limit hum and/or interference entering the signal path, use balanced input connections.

In the interests of safety, the unit MUST always operate with electrical safety earth connected to the chassis via the dedicated Protective Earth \oplus wire.

4:2.Analog audio input connections

Ottocanali Series amplifiers implements two analog input connections per channel: LINE and AUX input. Input selection is made via software or through the AUX SEL. IN switch (see [§4:2.1. AUX SEL. IN: Analog input selection](#)).

Analog input is provided by means of four Phoenix MC 1,5/12-ST-3,81 1803675 connectors (see [Panel D, p. 8](#) and [Panel F, p. 10](#)), two for LINE input (channels 1-to-4 and 5-to-8) and two dedicated to the AUX input (channels 1-to-4 and 5-to-8). Signal polarity of analog input connections is shown in [Panel G, p. 12](#).

4:2.1.AUX SEL. IN: Analog input selection

Ottocanali Series amplifiers can switch from analog LINE inputs to AUX inputs when a constant voltage in the $12V_{DC}$ to $30V_{DC}$ range is applied to the AUX SEL. IN connector (see [Panel D, p. 8](#) and [Panel F, p. 10](#)). When this voltage is removed from the AUX SEL. IN, the unit switches back from AUX inputs to LINE inputs.

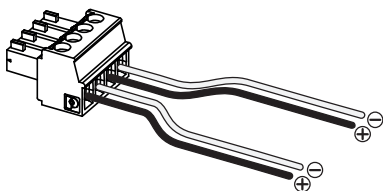

FIG. 2: AUX SEL. IN and PWS OUT connector and wirings.

4:2.2.PWS OUT: Built-in auxiliary power supply

The PWS OUT connector provides a $24V_{DC}$ – symmetrical with respect to ground (0.2 A max) – when enabled by the toggle switch on the front panel (see [Panel C, Panel D, p. 8](#) and [Panel E, Panel F, p. 10](#)).

By wiring the PWS OUT connector to the AUX SEL. IN as shown in [FIG. 3](#), the front panel PWS OUT switch is enabled to toggle between analog LINE inputs and AUX inputs: this provides an additional manual procedure to switch from analog LINE to AUX and vice versa.

4

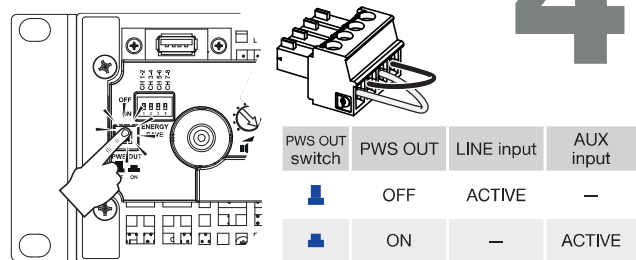

FIG. 3: Manual procedure to switch from LINE to AUX.

4:3.Digital audio input connections

Digital input is supported via Dante™ standard protocols in Dante equipped devices.

In Ottocanali DSP+D amplifiers, Dante connectivity is supported via two Ethernet ports located on the rightmost side of the rear panels (see [Panel F, p. 10](#)). Fast Ethernet (IEEE 802.3u, 100 Mbit/s) and Gigabit Ethernet (IEEE 802.3ab, 1 Gbit/s) network protocols are supported; Cat5e or Cat6 standard UTP twisted pair cables shall be used for connections up to 100 meters (328 ft).

Ethernet cabling must comply to TIA/EIA-568-B and adopt the T568B scheme pinout, as shown in [Panel L, p. 14](#).

4:3.1.Input selection and Backup policy

In Ottocanali DSP+D amplifiers it is possible to select among three input signal sources per channel: analog (either LINE or AUX) and two Dante streams (streams 1-to-8 and 9-to-16).

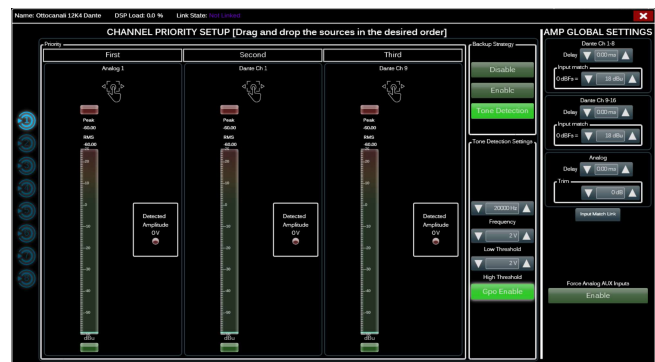

FIG. 4: Ottocanali DSP+D: Input selection and backup policy.

Armonia Pro Audio Suite provides an interface to select the proper input source and manage input gain and delay of analog and digital sources, in order to compensate transmission latency and levels (see [FIG. 4](#)).

Furthermore Ottocanali DSP+D amplifiers implement a backup policy aimed to improve reliability against signal fault. By assigning a bus priority to the three different input sources – analog and two Dante streams – per channel, the system is able to automatically switch to a reliable input connection in case of signal drop or pilot tone mismatch.

4:4.Ethernet connections

Ottocanali DSP+D amplifiers can be remotely controlled via an Ethernet connection through a personal computer and Powersoft Armonia Pro Audio Suite software. Powersoft recommend the use of Ethernet Cat5 straight through – patch – cables with pin/pair assignments TIA/EIA-568-B, i.e. T568B, as shown in [Panel L, p. 14](#).

4:5. Output connections

CLASS3 WIRING

Output terminals are hazardous: wiring connection to these terminals require installation by an instructed person and the use of ready made leads. Take care to secure the output terminal before switching the device on.

Output connectors are Phoenix PC 5/ 8-STF1-7,62 1777891: single-ended wirings for lo-Z loudspeaker and Hi-Z distributed lines connections are shown in [Panel H, p. 12](#). Bridge-tied connection of lo-Z loudspeaker is supported on adjacent channel pairs 1-2, 3-4, 5-6 and 7-8; inputs must be physically paralleled as shown in [Panel J, p. 12](#).

Any mixed configuration of low and high impedance output loads can be realized: in order to set the load configuration, each channel is provided by four DIP switches (refer to [Panel K, p. 13](#)). Ottocanali Series is configured to drive Lo-Z loads ([Panel K#1](#)) by factory default.

4:5.1. Hi-Z 70V/100V operations

Any channel of an Ottocanali Series amplifier can drive 70V/100V (Hi-Z) distributed line of loudspeakers. In order to connect any channel's output to a 70V/100V line, the rear panel DIP switch corresponding to the channel must be correctly set as reported in [Panel K, p. 13](#).

Powersoft recommends to use the built-in HPF (High Pass Filter) when the amplifier is set to drive a distributed line to prevent loudspeaker transformer saturation which can considerably degrade sound performance. The HPF can be activated by means of the DIP switch corresponding to the channel (see [Panel K, p. 13](#)): two cutting frequency are available 35 Hz and 70 Hz.

4:6. GPO - Alarms

The Ottocanali's GPO – general purpose output – system implements triggering signals to broadcast alarms.

Ottocanali Series provides a pair of paralleled general purpose output connections per channel: one Normally Open \ominus NO and one Normally Closed \oplus NC.

The connections are available on the back panel via two 12-pin Phoenix MC 1.5/12-ST-3.81 1803675 connectors for channels 1-to-4 and 5-to-8: see [Panel I, p. 12](#) for wirings.

These contacts are used to report potentially dangerous faults or generally unsafe operation conditions by toggling alarm switches relative to the following events:

- ▶ No AC mains (i.e. system shutdown);
- ▶ Thermal stress: the system temperature reaches 70°C, thermal protections are going to be engaged;
- ▶ Short circuit in output wiring: either the loudspeaker or the line is in short;
- ▶ DC presence at the output: a continuously stationary signal is present at output terminals.

Ottocanali DSP feature further monitoring on pilot tone and output load: the GPO monitoring interface in Armonía Pro Audio Suite software is accessible through the GPO button located at the top right corner in the dashboard of the selected Ottocanali DSP amplifier (refer to [Section 9](#) "[Armonía Pro Audio Suite](#)").



4:6.1. Pilot tone monitoring

Thanks to the built-in DSP, the Ottocanali DSP+D amplifiers implement pilot tone detection and alert. Detecting and alerting features are available for both input and output pilot tones on each channel.

The detection of a mismatch in the input pilot tone parameters (frequency and voltage level) can be used to trigger the backup policy (refer to [§4:3.1. Input selection and Backup policy](#)) and activate an alert through the general purpose output switch.

The output pilot tone detection relies on an external signal passing through the amplifier or the internal post DSP pilot tone generator (see [FIG. 4](#)); in both cases any mismatch between the detected signal and the set thresholds triggers the general purpose output switches.

4:6.2. Output load monitoring

Through Armonía Pro Audio Suite software it is possible to set the thresholds on the load impedance, at given frequency, that trigger the general purpose output of any channel of the amplifiers with DSP (see [FIG. 5](#)).

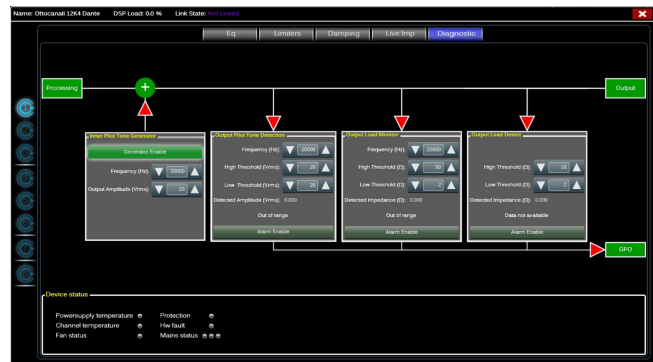

FIG. 5: GPO: System monitoring interface.

Attenuators

5

The row of potentiometers in the front panel behave differently on non-DSP amplifiers and Ottocanali DSP+D amplifiers:

- ▶ In non-DSP Ottocanali amplifiers, the potentiometers act as trimmers on the input level (see [Panel C, p. 8](#)): the input signal is muted when the trimmer is completely turned counterclockwise; on the other hand, no attenuation is applied when the trimmer is completely turned clockwise.
- ▶ In Ottocanali DSP the potentiometers attenuate the speakers gain (see [Panel E, p. 10](#)): they modify the overall gain applied to the group of ways belonging to the selected speaker. The amount of gain attenuation (External gain) is shown in Armonía Pro Audio Suite.

Firmware update

7

Firmware updates for Ottocanali DSP+D can be loaded via the front USB port. Updated releases of the Ottocanali DSP firmware are available on the Armonía forum (<http://www.powersoft-audio.com/en/armonia-forum>).

The package contains the firmware update file whose name is in the form:

update-version#-model.bin

(e.g. update-1.6.0.10-8ch.bin): store the firmware update file into a USB storage device and follow these instructions:

1. Switch the amplifier on and wait for the completion of the boot sequence.
2. Plug the USB storage device with the firmware update file to the USB port in the front panel of the amplifier.

LED chart

6

Color	Signal metering	Lighting	Warnings Description
RED	Clipping	SOLID ON	System temperature above 80°C ¹ (all channels muted)
YELLOW	-6dB	SOLID ON	System temperature above 70°C ² (thermal warning)
GREEN	-12dB	—	—
GREEN	-24dB	—	—
GREEN	signal presence (-60dBV)	—	—
GREEN	—	SOLID ON	Channel ready
GREEN	—	BLINKING	Channel muted ³
GREEN	—	BLINKING	AUX inputs are selected

¹ Even if only one channel causes thermal overload, all channels are muted and all red LEDs are on: normal operating is restored when the temperature falls under the thermal warning threshold.

² Even if only one channel causes thermal warning, all yellow LEDs are on: thermal protections are engaged.

³ Only available in Ottocanali DSP.

TAB. 2: Front panel LEDs chart.

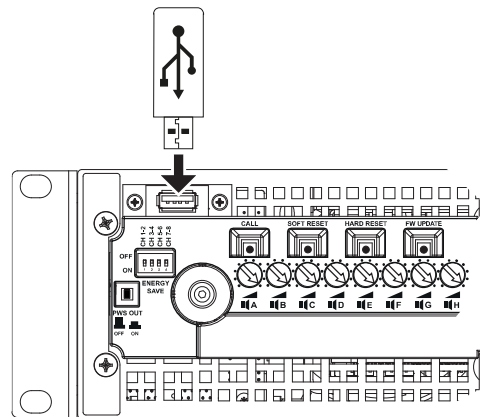

3. Keep pressed the FW UPDATE pushbutton until the front LED bars start blinking.

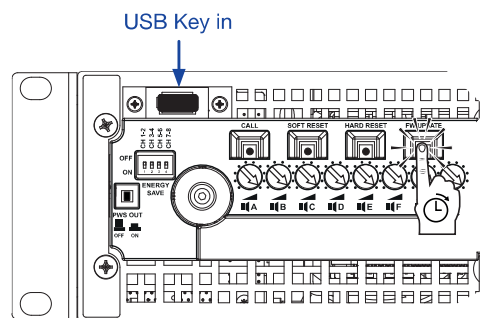

4. The update process lasts in 3-5 minutes. At the end the system reboots and it is possible to extract the USB storage device.

Ottocanali DSP+D amplifiers support linear daisy-chain, star and loop network topologies; in a daisy-chained network the PC with Armonia Pro Audio Suite must always be at one end of the chain.

Be aware that daisy-chaining does not guarantee reliability in production environment, since any fault may yield to network sectioning and lost of system control.

When efficiency and reliability are paramount, a redundant network topology is advisable. In order to exploit the Dante features, star and open daisy-chain network topology are allowed.

8:1.IP addressing

Factory default network settings are DHCP/AutoIP, in order for the amplifier platform to self-configure when connected to an existing LAN or PC. Fixed IP policy can also be adopted and configured through Armonia Pro Audio Suite.

If a DHCP server is not active within the network, the amplifier platform initiates a stateless address auto-configuration (i.e. Zero-configuration networking methodology – Zeroconf): it self assigns a local numeric network address (of the type 169.254.x.y – 172.31.*.* for the secondary network if present – with a subnet mask 255.255.0.0) and automatically distributes and resolves the hostnames of networked devices. For setting a static IP address please refer to the Armonia Pro Audio Suite user guide.

8:1.1.IP Addressing troubleshooting

When connecting the Ottocanali DSP+D to a network environment it may happen that Armonia Pro Audio Suite does not discover or import the amplifier.

Usually this is a problem of IP addressing: both Armonia and the Ottocanali DSP must belong to the same subnet. If a DHCP server is present on the network and a Ottocanali DSP amplifier is in AUTO IP, networking may become unstable.

As a rule of thumb, turn the DHCP server on before connecting the amplifiers.

IP addressing of an Ottocanali DSP+D amplifier is established during the bootstrap: when the Ottocanali DSP amplifier discovers a DHCP server on the network during the startup, it negotiates the networking parameters. If the Ottocanali DSP does not reveal a DHCP server on the network during the startup it set itself in AUTO IP mode.

8:2.Dante™ networking

The Dante equipped models of Ottocanali DSP+D amplifier support Dante redundant networking via the two Rj45 ports on the rear panel:

- ▶ Primary/ETH1 is the Primary network port;
- ▶ Secondary/ETH2 is the Secondary network port.

Dante connectivity is always supported on the Primary/ETH1 Gigabit Ethernet port; the Secondary/ETH2 Gigabit Ethernet port offers continuity of operation when a parallel redundant network is established.

In order to implement a Dante network, a computer running Dante Controller have to be used. Dante Controller is a software application that manages devices on the network. Ottocanali DSP+D amplifiers are automatically discovered and displayed in Dante Controller with the default identifier *MODELNAME-SERIAL* (e.g. 8K4-71520).

Dante networks will almost always require at least one network switch. Redundant infrastructures may require multiple switches. For maximum reliability, network switch shall:

- ▶ be Rated for Gigabit Ethernet;
- ▶ be Non-blocking;
- ▶ have Quality of Service (QoS) with at least four queues;
- ▶ have Diffserv (DSCP) QoS with strict priority;
- ▶ have EEE (Energy efficient ethernet) switched off.

For detailed information on setting up a switch, please refer to the manufacturer's documentation.

8:2.1.Redundant network configuration

Dante Redundancy can be set up and used between any supporting Dante-enabled audio equipment: it works by using two completely independent and separate networks, the Primary Network and the Secondary Network.

To setup and use Dante Redundancy, connect the Ottocanali DSP+D amplifier and other redundant Dante-enabled audio equipment using duplicate Gigabit switches and Ethernet cables. Connect your computer running Dante Virtual Soundcard and Dante Controller, and other non-redundant Dante-enabled audio equipment to the Primary Network.

The primary and secondary networks MUST NOT be interconnected at any point. Make sure any computer is set to automatically configure its IP address.

Armonía Pro Audio Suite is the default configuring interface that allows system setting and customization of the Ottocanali DSP+D amplifiers.

Armonía can be installed on a PC running Windows (XP SP3 and higher). Freely download Armonía Pro Audio Suite from the Armonía forum:

<http://www.powersoft-audio.com/en/armonia-forum>

Ottocanali DSP amplifiers can connect to the PC running Armonía through a Fast Ethernet connection. In order to start remote operation, the device must be discovered and imported into the Armonía Workspace. Click on the Discover button in the Remote entities windows, or select it from the Model list and drag it into the Armonía Workspace.

The callback button – located on the front panel of the amplifier – allows you to highlight the presence of the amplifier into the Armonía Workspace.

Once connected to Armonía Pro Audio Suite a double click on the amplifier icon in the Workspace will open the amplifier dashboard. Here it is possible to access and configure all the features of the Ottocanali DSP.

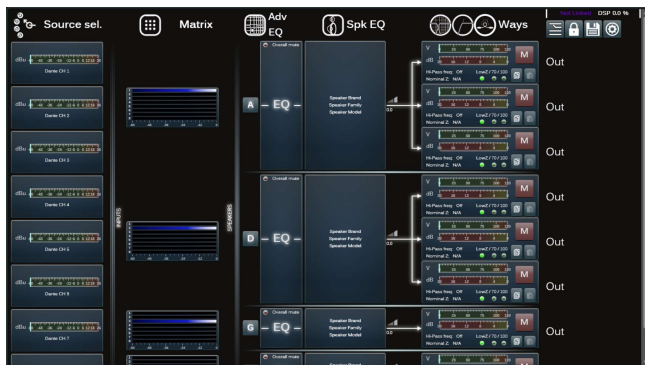

FIG. 6: Armonía Pro Audio Suite.

9:1.Signal routing and DSP architecture

Signal processing on Powersoft Ottocanali DSP amplifiers accomplishes multiple functions that affect the audio signal before power amplification; the main adjustments include gain, polarity, delay, limiting and signal equalization; some processing are related only to particular stages, such as limiting and damping control that are implemented on the output section only, or input priority assignment available in the input section.

The processing architecture is composed of six sections:

- ▶ Input source selection. The input section allows you to manage input gain and delay of analog and digital sources, in order to compensate transmission latency and levels. Furthermore the Ottocanali DSP+D implement a backup policy aimed to improve reliability against signal fault.
- ▶ Matrix. The innovative routing engine of Ottocanali DSP allows any input to be routed to any output. The Matrix implements a non-boolean routing architecture allowing free channel assignment and level adjustment.

- ▶ Advanced processing. This allows you to optimize levels and shape the sound of the input signals. Gain and polarity adjustment, asymmetric raised-cosine full parametric filters, delay and mute are available on each channel routed to the speaker section.
- ▶ Speaker equalization. Designed to manage the configuration presets for multi-way systems, it implements FIR and IIR full parametric filters.
- ▶ Speaker routing. Once properly grouped, the output channels are presented to the matrix as speakers – a single row representing a speaker (actually group of ways) – allowing a high grade of granularity in signal processing.
- ▶ Output processing. This allows fine tuning of output signals, aiming to optimize power delivering and loudspeaker performance. It provides gain and polarity adjustment, IIR and FIR full parametric filters, delay, mute, limiting and damping control on each output channel.

9:2.Purposed workflow

Once the loudspeaker layout has been defined, we suggest a bottom-up configuration procedure that starts from the configuration of the transducers layout and raises toward the input selection and the definition of the backup policy.

Shortly, the main steps to follow are:

1. Set Lo-Z and Hi-Z loads and filters on output channels.
2. Load the loudspeaker presets or manually configure the loudspeaker layout (grouping output channels, crossovering, limiting, speaker processing, etc.).
3. Define the routing path and the levels of the signals from the input channels to the active output channels (matrix).
4. Select the signal source from the input connections and define the backup policy (input source selection).
5. Define GPO assignment and alarms thresholds.

Warranty and assistance

10

10:1.Warranty

Powersoft guarantees its manufactured products to be free from defective components and factory workmanship for a period of time starting from the date of purchase printed on Powersoft's (or any of its Authorized Dealer's) invoice to the end customer. The standard warranty period are:

- ▷ 51 months for racks amplifiers.
- ▷ 12 month for amplifier modules.

All warranty repairs and retrofits must be performed at Powersoft facilities or at an Authorized Service Center at no cost for the purchaser. Warranty exclusion: Powersoft's warranty does not cover product malfunctioning or failure caused by: misuse, abuse, repair work or alterations performed by non-authorized personnel, incorrect connections, exposure to harsh weather conditions, mechanical damages (including shipping accidents), and normal wear and tear. Powersoft will perform warranty services provided that the product is not damaged during transportation.

10:1.1.Return of Goods

Goods can be returned to Powersoft only after they have been granted a Return Merchandise Authorization (RMA) number to be attached to the external packaging. Powersoft (or its Authorized Service Center) has the right to refuse any returned good without a RMA number.

10:1.2.Repair or replacement

Powersoft reserves the right to repair or replace any defective goods covered by product warranty at its sole discretion and as it deems best.

10:1.3.Cost and responsibility of transport

The purchaser (or end user/customer) is solely responsible for all transportation costs and risks associated with sending warranty covered goods to Powersoft or its Authorized Service Center. Powersoft will assume full responsibility and cover all costs incurred to send the goods back to the purchaser (or end user/customer).

10:2.Assistance

There are no user-serviceable parts in the amplifier. Refer to qualified technical personnel for servicing. In addition to having an in-house service department, Powersoft supports a network of Authorized Service Centers. If your amplifier needs repair, contact your Powersoft dealer (or distributor). You can also contact the Powersoft Technical Service department to obtain the location of the nearest Authorized Service Center.

Powersoft offers two options for product repair:

- ▶ Drop off at a Powersoft Authorized Service Centre near you.
- ▶ Ship the product to Powersoft S.p.a. for Factory Service.

10:2.1.Drop off at a Powersoft Authorized Service Centre near you

- ▶ Find a Powersoft Authorized Service Centre from the list.
- ▶ Take a note of each serial number of the units to be returned.
- ▶ Completely fill out the defect report form for each unit to be returned.
- ▶ Send the completed defect report form to the following e-mail addresses marco.mannucci@powersoft.it (Customer care manager) service@powersoft.it (Service Team).

After having applied the aforementioned procedure, the local service manager will provide the shipment details and the product's warranty status.

10:2.1.1.In-Warranty repairs:

The service repair will be free of charge for the customer.

10:2.1.2.Out of Warranty Issues

- ▶ The service costs are calculated on the local rate applied from the service centre and supervised by the Powersoft HQ
- ▶ The repair time has been set from the Powersoft HQ and it's equally applied in all the authorized service centre
- ▶ The unit will be evaluated by a technician, and the service centre will provide the customer with the estimated costs. The repair will only take place once the customer has approved the estimated costs. The customer will pay the shipping charges once the repair has been completed, depending on the countries' standard procedures.

For any enquiries please contact Powersoft Customer care service@powersoft.it

10:2.2.Shipping the product to Powersoft S.p.a. for Factory service centre

- ▶ Take a note of each serial number of the units to be returned.
- ▶ Fill out completely the defect report form for each unit to be returned.
- ▶ Send the completed defect report form to the following email address:
service@powersoft.it

After having applied the aforementioned procedure, you will receive an Email containing the Return Merchandise Authorization (RMA form) for each unit returned.

All returned Powersoft units must be shipped to the following address:

Powersoft spa
Factory service centre
Via Enrico Conti N. 13 – 15
50018 Scandicci (FI)
Italy
Phone +39 (055) 7350230 Option 2
Email: service@powersoft.it

Contact Powersoft Factory service centre
Phone +39 (055) 7350230 Option 2
Email: service@powersoft.it

Phone Support Hours
Monday - Friday 8.30 AM to 5.30 PM Europe time

10:2.2.1. Shipment from NON-CE countries

When shipping from non-CE (European Community) countries, follow the procedure described in the TEMPORARY EXPORTATION / IMPORTATION PROCEDURE.

Important Note:

If the RMA# is not displayed anywhere on the outside of the box, the shipment will be rejected and sent back to the customer.

If the returned goods from NON-CE countries do not follow the aforementioned guidelines, the package will be rejected and sent back to the customer.

10:2.3.D.0.A. Procedure

In case of a D.O.A. (Dead On Arrival) product, we kindly request the customer to contact the local dealer where the product was purchased or the Factory service centre, mentioning the serial number of the faulty unit.

D.O.A. unit will be replaced completely without any additional charges!

Important Note: Do not tamper with or operate the D.O.A. unit in any ways in order to avoid any warranty issue.

Powersoft S.p.a declines any D.O.A warranty service if the returned unit has been tampered with or misused by the customer.

Ottocanali 12K4

Ottocanali 12K4 DSP+D

Specifications

Channel Handling

Number of output channels	8 mono Lo-Z (bridgeable per ch. pair) / Hi-Z (2x Phoenix PC 5/ 8-STF1-7,62)	
Number of input channels:		
Analog*	LINE	8 (2x Phoenix MC 1,5/12-ST-3,81)
	AUX	8 (2x Phoenix MC 1,5/12-ST-3,81)
Dante™**	16 (2x RJ45 redundant)	

Audio

Gain (dB/voltage)	32 dB / x40 V
Frequency Response (±0.5 dB, 1 W @ 4 Ω)	20 Hz - 20 kHz
Crosstalk @ 1 kHz, 4 Ω load	> 65 dB
THD+N (from 0.1 W to Full Power @ 4 Ω load)	< 0,08% (typical < 0,05%)
DIM (from 0.1 W to Full Power @ 4 Ω load)	< 0,08% (typical < 0,05%)
Input Impedance	10 kΩ Balanced
Input sensitivity @ 8 Ω	1,94 V / +8 dBu
Max input level	6 V / +17,8 dBu
Noise Floor (20 Hz - 20 kHz A-Weighted @ 8 Ω)	< -70 dB
S/N ratio (20 Hz - 20 kHz A-Wtd @ 8 Ω amplifier section)	> 109 dB
Damping Factor @ 8 Ω, 100Hz	> 10000
Slew Rate @ 8 Ω, input filter bypassed	> 50 V/μs
Output high pass filter	OFF/35 Hz/70Hz

DSP***

AD converters	24 Bit Tandem™ @ 96 kHz 129 dB Dynamic Range - 0,00056 % THD+N
DA converters	24 Bit Tandem™ @ 192 kHz 121 dB Dynamic Range - 0,00084 % THD+N
Sample rate converter	24 Bit @ 44,1 kHz to 192 kHz 140 dB Dynamic Range - 0,0001 % THD+N
Internal precision	40 bit floating point
Delay	2 s + 100 ms for time alignment
Equalizer	Raised-cosine, custom FIR, parametric IIR: peaking, hi/lo-shelving, all-pass, band-pass, band-stop, hi/lo-pass
Crossover	linear phase (FIR), hybrid (FIR-IIR), Butterworth, Linkwitz-Riley, Bessel: 6 dB/oct to 48 dB/oct (IIR)
Limiters	TruePower™, RMS voltage, RMS current, Peak limiter
Damping control	Active DampingControl™

Networking***

Ports	2x RJ45 ports on rear panel
Protocols	Dante™ by Audinate® **, Dante™ redundant **, Gigabit Ethernet (IEEE 802.3ab, 1 Gbit/s), Fast Ethernet (IEEE 802.3u, 100 Mbit/s)
Topologies	Star, daisy chain, looped daisy chain, redundant stars

* Two switchable analog input connections per input channel.

** Ottocanali 12K4 DSP+D version only

Output Stage

Maximum output power per channel @ 2 Ω	1100 W
Maximum output power per channel @ 4 Ω	1500 W
Maximum output power per channel @ 8 Ω	850 W
Maximum output power @ 4 Ω Bridged	3000 W
Maximum output power @ 8 Ω Bridged	2200 W
Maximum output power @ Hi-Z, 70 V distributed line	1500 W
Maximum output power @ Hi-Z, 100 V distributed line	1500 W
Peak total output, all channels driven	12000 W
Maximum unclipped output voltage (Lo-Z)	150 V _{peak}
Maximum output current (Lo-Z)	54 A _{peak}

The power figure is calculated by driving and loading symmetrically all the channels: uneven loads allow to achieve highest performance.

AC Mains Power

Power supply	Dual redundant, universal switch mode			
Nominal Voltage	100 - 240 V @ 50/60 Hz			
Operating Range	90 - 264 V			
Power Factor 1/8 Max. Power @ 4 Ω	> 0,9			
Consumption	115 V		230 V	
Idle	30 W	0,6 A	35 W	0,8 A
1/8 Max. Power @ 4 Ω	2075 W	18,5 A	2115 W	9,7 A
1/4 Max. Power @ 4 Ω	4150 W	36 A	4230 W	18,6 A

Thermal

Operating temperature	0° - 35°C / 32° - 95°F			
Cooling	Fan, continuously variable speed, temperature controlled			
Consumption	115 V		230 V	
Idle	103 BTU/h	26 kcal/h	118 BTU/h	30 kcal/h
1/8 Max. Power @ 4 Ω	2141 BTU/h	540 kcal/h	1937 BTU/h	488 kcal/h
1/4 Max. Power @ 4 Ω	4283 BTU/h	1080 kcal/h	3874 BTU/h	977 kcal/h

GPO (Alarms)

Remote ON/OFF (standby) switch
One pair of NC and NO terminals per channel triggered by:
System shutdown
Thermal stress (system temperature above 70°C)
Short circuit in output wiring
DC presence at the output
Input pilot tone out of range**
Output pilot tone out of range**
Output load out of range**

Construction

Dimensions (LxWxH)	482 mm x 382 mm x 89 mm (19 in x 15 in x 3,5 in)
Weight	14 kg (30,8 lb)

Ottocanali 8K4

Ottocanali 8K4 DSP+D

Specifications

Channel Handling

Number of output channels	8 mono Lo-Z (bridgeable per ch. pair) / Hi-Z (2x Phoenix PC 5/ 8-STF1-7,62)	
Number of input channels:		
Analog*	LINE	8 (2x Phoenix MC 1,5/12-ST-3,81)
	AUX	8 (2x Phoenix MC 1,5/12-ST-3,81)
Dante™**	16 (2x RJ45 redundant)	

Audio

Gain (dB/voltage)	32 dB / x40 V
Frequency Response (±0,5 dB, 1 W @ 4 Ω)	20 Hz - 20 kHz
Crosstalk @ 1 kHz, 4 Ω load	> 65 dB
THD+N (from 0,1 W to Full Power @ 4 Ω load)	< 0,08% (typical < 0,05%)
DIM (from 0,1 W to Full Power @ 4 Ω load)	< 0,08% (typical < 0,05%)
Input Impedance	10 kΩ Balanced
Input sensitivity @ 8 Ω	1,94 V / +8 dBu
Max input level	6 V / +17,8 dBu
Noise Floor (20 Hz - 20 kHz A-Weighted @ 8 Ω)	< -70 dB
S/N ratio (20 Hz - 20 kHz A-Wtd @ 8 Ω amplifier section)	> 107 dB
Damping Factor @ 8 Ω, 100Hz	> 10000
Slew Rate @ 8 Ω, input filter bypassed	> 50 V/μs
Output high pass filter	OFF / 35 Hz / 70 Hz

DSP**

AD converters	24 Bit Tandem™ @ 96 kHz 129 dB Dynamic Range - 0,00056 % THD+N
DA converters	24 Bit Tandem™ @ 192 kHz 121 dB Dynamic Range - 0,00084 % THD+N
Sample rate converter	24 Bit @ 44,1 kHz to 192 kHz 140 dB Dynamic Range - 0,0001 % THD+N
Internal precision	40 bit floating point
Delay	2 s + 100 ms for time alignment
Equalizer	Raised-cosine, custom FIR, parametric IIR: peaking, hi/lo-shelving, all-pass, band-pass, band-stop, hi/lo-pass
Crossover	linear phase (FIR), hybrid (FIR-IIR), Butterworth, Linkwitz-Riley, Bessel: 6 dB/oct to 48 dB/oct (IIR)
Limiters	TruePower™, RMS voltage, RMS current, Peak limiter
Damping control	Active DampingControl™

Networking***

Ports	2x RJ45 ports on rear panel
Protocols	Dante™ by Audinate® **, Dante™ redundant **, Gigabit Ethernet (IEEE 802.3ab, 1 Gbit/s), Fast Ethernet (IEEE 802.3u, 100 Mbit/s)
Topologies	Star, daisy chain, looped daisy chain, redundant stars

* Two switchable analog input connections per input channel.

** Ottocanali 12K4 DSP+D version only

Output Stage

Maximum output power per channel @ 2 Ω	850 W
Maximum output power per channel @ 4 Ω	1000 W
Maximum output power per channel @ 8 Ω	600 W
Maximum output power @ 4 Ω Bridged	1700 W
Maximum output power @ 8 Ω Bridged	2000 W
Maximum output power @ Hi-Z, 70 V distributed line	1000 W
Maximum output power @ Hi-Z, 100 V distributed line	1000 W
Peak total output, all channels driven	8000 W
Maximum unclipped output voltage (Lo-Z)	90 V _{peak}
Maximum output current (Lo-Z)	23 A _{peak}

The power figure is calculated by driving and loading symmetrically all the channels: uneven loads allow to achieve highest performance.

AC Mains Power

Power supply	Dual redundant, universal switch mode			
Nominal Voltage	100 - 240 V @ 50/60 Hz			
Operating Range	90 - 264 V			
Power Factor 1/8 Max. Power @ 4 Ω	> 0,9			
Consumption	115 V		230 V	
Idle	30 W	0,6 A	35 W	0,8 A
1/8 Max. Power @ 4 Ω	1425 W	12,6 A	1425 W	6,6 A
1/4 Max. Power @ 4 Ω	2800 W	24,5 A	2760 W	12,3 A

Thermal

Operating temperature	0° - 35°C / 32° - 95°F			
Cooling	Fan, continuously variable speed, temperature controlled			
Consumption	115 V		230 V	
Idle	103 BTU/h	26 kcal/h	118 BTU/h	30 kcal/h
1/8 Max. Power @ 4 Ω	1480 BTU/h	373 kcal/h	1504 BTU/h	379 kcal/h
1/4 Max. Power @ 4 Ω	2792 BTU/h	704 kcal/h	2722 BTU/h	686 kcal/h

GPO (Alarms)

Remote ON/OFF (standby) switch
One pair of NC and NO terminals per channel triggered by:
System shutdown
Thermal stress (system temperature above 70°C)
Short circuit in output wiring
DC presence at the output
Input pilot tone out of range**
Output pilot tone out of range**
Output load out of range**

Construction

Dimensions (LxWxH)	482 mm x 382 mm x 89 mm (19 in x 15 in x 3,5 in)
Weight	14 kg (30,8 lb)

Ottocanali 4K4

Ottocanali 4K4 DSP+D

Specifications

Channel Handling

Number of output channels	8 mono Lo-Z (bridgeable per ch. pair) / Hi-Z (2x Phoenix PC 5/ 8-STF1-7,62)	
Number of input channels:		
Analog*	LINE	8 (2x Phoenix MC 1,5/12-ST-3,81)
	AUX	8 (2x Phoenix MC 1,5/12-ST-3,81)
Dante™**	16 (2x RJ45 redundant)	

Audio

Gain (dB/voltage)	32 dB / x40 V
Frequency Response (±0,5 dB, 1 W @ 4 Ω)	20 Hz - 20 kHz
Crosstalk @ 1 kHz, 4 Ω load	> 65 dB
THD+N (from 0,1 W to Full Power @ 4 Ω load)	< 0,08% (typical < 0,05%)
DIM (from 0,1 W to Full Power @ 4 Ω load)	< 0,08% (typical < 0,05%)
Input Impedance	10 kΩ Balanced
Input sensitivity @ 8 Ω	1,94 V / +8 dBu
Max input level	6 V / +17,8 dBu
Noise Floor (20 Hz - 20 kHz A-Weighted @ 8 Ω)	< -70 dB
S/N ratio (20 Hz - 20 kHz A-Wtd @ 8 Ω amplifier section)	> 107 dB
Damping Factor @ 8 Ω, 100Hz	> 10000
Slew Rate @ 8 Ω, input filter bypassed	> 50 V/μs
Output high pass filter	OFF / 35 Hz / 70 Hz

DSP**

AD converters	24 Bit Tandem™ @ 96 kHz 129 dB Dynamic Range - 0,00056 % THD+N
DA converters	24 Bit Tandem™ @ 192 kHz 121 dB Dynamic Range - 0,00084 % THD+N
Sample rate converter	24 Bit @ 44,1 kHz to 192 kHz 140 dB Dynamic Range - 0,0001 % THD+N
Internal precision	40 bit floating point
Delay	2 s + 100 ms for time alignment
Equalizer	Raised-cosine, custom FIR, parametric IIR: peaking, hi/lo-shelving, all-pass, band-pass, band-stop, hi/lo-pass
Crossover	linear phase (FIR), hybrid (FIR-IIR), Butterworth, Linkwitz-Riley, Bessel: 6 dB/oct to 48 dB/oct (IIR)
Limiters	TruePower™, RMS voltage, RMS current, Peak limiter
Damping control	Active DampingControl™

Networking***

Ports	2x RJ45 ports on rear panel
Protocols	Dante™ by Audinate® **, Dante™ redundant **, Gigabit Ethernet (IEEE 802.3ab, 1 Gbit/s), Fast Ethernet (IEEE 802.3u, 100 Mbit/s)
Topologies	Star, daisy chain, looped daisy chain, redundant stars

* Two switchable analog input connections per input channel.

** Ottocanali 12K4 DSP+D version only

Output Stage

Maximum output power per channel @ 2 Ω	450 W
Maximum output power per channel @ 4 Ω	500 W
Maximum output power per channel @ 8 Ω	250 W
Maximum output power @ 4 Ω Bridged	900 W
Maximum output power @ 8 Ω Bridged	1000 W
Maximum output power @ Hi-Z, 70 V distributed line	500 W
Maximum output power @ Hi-Z, 100 V distributed line	500 W
Peak total output, all channels driven	4000 W
Maximum unclipped output voltage (Lo-Z)	65 V _{peak}
Maximum output current (Lo-Z)	15 A _{peak}

The power figure is calculated by driving and loading symmetrically all the channels: uneven loads allow to achieve highest performance.

AC Mains Power

Power supply	Dual redundant, universal switch mode			
Nominal Voltage	100 - 240 V @ 50/60 Hz			
Operating Range	90 - 264 V			
Power Factor 1/8 Max. Power @ 4 Ω	> 0,9			
Consumption	115 V		230 V	
Idle	30 W	0,6 A	35 W	0,8 A
1/8 Max. Power @ 4 Ω	740 W	6,6 A	750 W	3,9 A
1/4 Max. Power @ 4 Ω	1400 W	12,4 A	1405 W	6,9 A

Thermal

Operating temperature	0° - 35°C / 32° - 95°F			
Cooling	Fan, continuously variable speed, temperature controlled			
Consumption	115 V		230 V	
Idle	103 BTU/h	26 kcal/h	118 BTU/h	30 kcal/h
1/8 Max. Power @ 4 Ω	801 BTU/h	202 kcal/h	839 BTU/h	211 kcal/h
1/4 Max. Power @ 4 Ω	1340 BTU/h	338 kcal/h	1340 BTU/h	338 kcal/h

GPO (Alarms)

Remote ON/OFF (standby) switch	
One pair of NC and NO terminals per channel triggered by:	
System shutdown	
Thermal stress (system temperature above 70°C)	
Short circuit in output wiring	
DC presence at the output	
Input pilot tone out of range**	
Output pilot tone out of range**	
Output load out of range**	

Construction

Dimensions (LxWxH)	482 mm x 382 mm x 89 mm (19 in x 15 in x 3,5 in)
Weight	14 kg (30,8 lb)



Powersoft S.p.A.
Via Enrico Conti, 5
50018 Scandicci (FI) Italy

Tel: +39 055 735 0230
Fax: +39 055 735 6235

General inquiries: info@powersoft.it
Sales: sales@powersoft.it
Application & technical support: support@powersoft.it
Service & maintenance: service@powersoft.it

powersoft-audio.com