

**PowerLite<sup>®</sup> Pro**  
**Z9870NL/Z11005NL/Z9800WNL/  
Z9900WNL/Z11000WNL/Z9750UNL/  
Z9870UNL/Z10000UNL/Z10005UNL**  
**User's Guide**



---

# Contents

<b>PowerLite Pro Z9870NL/Z11005NL/Z9800WNL/Z9900WNL/ Z11000WNL/Z9750UNL/Z9870UNL/Z10000UNL/Z10005UNL User's Guide</b> .....	<b>11</b>
<b>Introduction to Your Projector</b> .....	<b>12</b>
Projector Features.....	12
Product Box Contents.....	13
Additional Components .....	15
Optional Equipment and Replacement Parts.....	15
Warranty and Registration Information .....	17
Notations Used in the Documentation .....	18
Where to Go for Additional Information .....	18
Projector Part Locations .....	18
Projector Parts - Front/Top .....	19
Projector Parts - Rear .....	20
Projector Parts - Interface Ports .....	21
Projector Parts - Base.....	22
Projector Parts - Control Panel .....	23
Projector Parts - Remote Control.....	25
<b>Setting Up the Projector</b> .....	<b>28</b>
Projector Placement.....	28
Projector Setup and Installation Options .....	28
Projection Distance.....	34
Removing and Attaching the Interface Cover .....	37
Projector Connections .....	38
Connecting to Computer Sources.....	39
Connecting to a Computer for VGA Video.....	39
Connecting to a Computer for HDMI Video .....	40
Connecting to a Computer for DVI-D Video .....	40
Connecting to a Computer for 5 BNC Video.....	41
Connecting to Video Sources .....	41
Connecting to an HDMI Video Source .....	42

Connecting to a Component-to-BNC Video Source .....	42
Connecting to a Component Video Source .....	43
Connecting to an S-Video Video Source .....	44
Connecting to a Composite Video Source .....	45
Connecting to an SDI Video Source.....	45
Connecting to an HDBaseT Transmitter .....	46
Connecting to an External Computer Monitor .....	47
Attaching and Removing a Lens.....	48
Removing a Lens .....	48
Attaching a Lens .....	50
Attaching and Removing the Cable Clips .....	52
Installing Batteries in the Remote Control .....	53
<b>Using the Projector on a Network .....</b>	<b>55</b>
Wired Network Projection.....	55
Connecting to a Wired Network .....	56
Selecting Wired Network Settings .....	56
Wireless Network Projection .....	59
Installing the Wireless LAN Module .....	60
Using Quick Wireless Connection (Windows Only) .....	62
Selecting Wireless Network Settings Manually.....	64
Wireless LAN Menu Settings .....	66
Selecting Wireless Network Settings in Windows .....	68
Selecting Wireless Network Settings in OS X.....	68
Setting Up Wireless Network Security .....	68
Wireless Security Menu Settings .....	69
Setting Up Projector Network E-Mail Alerts .....	70
Network Projector E-mail Alert Messages .....	71
Setting Up Monitoring Using SNMP .....	71
Controlling a Networked Projector Using a Web Browser .....	73
Operating a Lens from a Web Browser.....	74
Crestron RoomView Support.....	76
Setting Up Crestron RoomView Support .....	77
Controlling a Networked Projector Using Crestron RoomView .....	78

<b>Using Basic Projector Features .....</b>	<b>80</b>
Turning On the Projector .....	80
Turning Off the Projector .....	82
Selecting the Language for the Projector Menus.....	82
Setting the Screen Type .....	83
Adjusting the Image Position Using Lens Shift .....	84
Adjusting the Image Position Using Screen Position .....	86
Displaying a Test Pattern .....	87
Available Test Pattern Image Adjustments .....	88
Adjusting the Image Height .....	89
Image Shape .....	90
Correcting Image Shape with H/V Keystone.....	90
Correcting Image Shape with Quick Corner .....	93
Correcting Image Shape with Curved Surface .....	95
Correcting Image Shape with Point Correction.....	99
Correcting Image Shape with Corner Wall.....	101
Resizing the Image with the Zoom Button .....	106
Focusing the Image Using the Focus Button.....	106
Focusing the Image with the Optional Short Throw Lens.....	107
Remote Control Operation .....	109
Selecting an Image Source .....	110
Selecting the Lamp.....	111
Projection Modes .....	112
Changing the Projection Mode Using the Menus.....	113
Image Aspect Ratio .....	113
Changing the Image Aspect Ratio .....	114
Available Image Aspect Ratios .....	114
Color Mode.....	115
Changing the Color Mode.....	116
Available Color Modes.....	116
Turning On Auto Iris.....	117
Setting the Date and Time .....	118

<b>Adjusting Projector Features .....</b>	<b>120</b>
Shutting Off the Picture Temporarily .....	120
Stopping Video Action Temporarily .....	121
Zooming Into and Out of Images .....	121
Projector Security Features .....	122
Password Security Types .....	122
Setting a Password .....	123
Selecting Password Security Types .....	124
Entering a Password to Use the Projector .....	125
Saving a User's Logo Image to Display .....	126
Locking the Projector's Buttons .....	127
Unlocking the Projector's Buttons .....	128
Installing a Security Cable .....	129
Using Multiple Projectors .....	130
Projector Identification System for Multiple Projector Control .....	131
Setting the Projector ID .....	131
Setting the Remote Control ID .....	132
Adjusting the Position of the Projected Image From Multiple Projectors .....	133
Matching the Image Colors .....	134
Adjusting the Color Tone (Color Uniformity) .....	135
Adjusting the Color Convergence (Panel Alignment) .....	136
Scaling an Image .....	139
Projecting Two Images Simultaneously .....	141
Adjusting the Lamp's Brightness .....	142
Blending the Image Edges .....	143
Adjusting the Black Level .....	145
Copying Menu Settings Between Projectors .....	148
Saving Settings to a USB Flash Drive .....	149
Transferring Settings From a USB Flash Drive .....	150
Saving Settings to a Computer .....	151
Transferring Settings From a Computer .....	153
Using Frame Interpolation .....	155
Viewing 3D Images .....	156

Saving Settings to Memory and Using Saved Settings .....	156
Scheduling Projector Events .....	158
Saving a Scheduled Event.....	158
Viewing Scheduled Events .....	158
Editing a Scheduled Event.....	159
<b>Adjusting the Menu Settings .....</b>	<b>161</b>
Using the Projector's Menus.....	161
Image Quality Settings - Image Menu .....	163
Input Signal Settings - Signal Menu.....	165
Projector Feature Settings - Settings Menu.....	169
Projector Setup Settings - Extended Menu.....	172
Projector Network Settings - Network Menu.....	179
Projector Information Display - Info Menu .....	180
Event ID Code List.....	182
Projector Reset Options - Reset Menu .....	183
<b>Maintaining and Transporting the Projector .....</b>	<b>185</b>
Projector Maintenance .....	185
Cleaning the Lens.....	185
Cleaning the Projector Case.....	186
Air Filter and Vent Maintenance .....	186
Cleaning the Air Filter.....	187
Replacing the Air Filter.....	190
Projector Lamp Maintenance.....	193
Replacing the Lamp .....	193
Resetting the Lamp Timer .....	197
Replacing the Remote Control Batteries .....	198
Transporting the Projector .....	200
<b>Solving Problems .....</b>	<b>202</b>
Projection Problem Tips .....	202
Projector Light Status .....	203
Projector Status Display .....	208
Using the Projector Status Display .....	209
Adjusting the Projector Status Display.....	210

Projector Status Display Messages .....	210
Using the Projector Help Displays .....	218
Solving Image Problems .....	219
Solutions When No Image Appears.....	219
Solutions When "No Signal" Message Appears.....	220
Displaying From a PC Laptop .....	221
Displaying From a Mac Laptop .....	221
Solutions When "Not Supported" Message Appears .....	221
Solutions When Only a Partial Image Appears .....	222
Solutions When the Image is Not Rectangular .....	222
Solutions When the Image Contains Noise or Static .....	223
Solutions When the Image is Fuzzy or Blurry .....	223
Solutions When the Image Brightness or Colors are Incorrect .....	224
Solving Projector or Remote Control Operation Problems .....	225
Solutions to Projector Power or Shut-Off Problems .....	225
Solutions to Problems with the Remote Control.....	226
Solutions to Password Problems .....	227
Solutions When Network Alert E-Mails are Not Received .....	227
Where to Get Help.....	228
<b>Technical Specifications .....</b>	<b>230</b>
General Projector Specifications .....	230
Projector Lamp Specifications.....	235
Remote Control Specifications .....	236
Projector Dimension Specifications.....	236
Projector Electrical Specifications .....	237
Projector Environmental Specifications.....	239
Projector Safety and Approvals Specifications.....	239
Supported Video Display Formats.....	239
<b>Notices .....</b>	<b>243</b>
Recycling.....	243
Important Safety Information .....	243
Important Safety Instructions.....	244
Restriction of Use .....	247



FCC Compliance Statement.....	247
Trademarks .....	248
Open Source Software License.....	248
Copyright Notice.....	293
A Note Concerning Responsible Use of Copyrighted Materials.....	294
Copyright Attribution .....	294



---

# **PowerLite Pro Z9870NL/Z11005NL/Z9800WNL/Z9900WNL/ Z11000WNL/Z9750UNL/Z9870UNL/Z10000UNL/Z10005UNL User's Guide**

Welcome to the PowerLite Pro Z9870NL/Z11005NL/Z9800WNL/Z9900WNL/Z11000WNL/Z9750UNL/  
Z9870UNL/Z10000UNL/Z10005UNL *User's Guide*.

---

# Introduction to Your Projector

Refer to these sections to learn more about your projector and this manual.

[Projector Features](#)

[Notations Used in the Documentation](#)

[Where to Go for Additional Information](#)

[Projector Part Locations](#)

## Projector Features

The PowerLite Pro Z9870NL, Z11005NL, Z9800WNL, Z9900WNL, Z11000WNL, Z9750UNL, Z9870UNL, Z10000UNL, and Z10005UNL projectors include these special features:

### Bright, high-resolution projection system

- PowerLite Pro Z9750UNL: Up to 3750 (one lamp) or 7500 (two lamps) lumens of color brightness (color light output) or white brightness (white light output) in standard mode

PowerLite Pro Z9870NL/Z9870UNL: Up to 4350 (one lamp) or 8700 (two lamps) lumens of color brightness (color light output) or white brightness (white light output) in standard mode

PowerLite Pro Z9800WNL: Up to 4150 (one lamp) or 8300 (two lamps) lumens of color brightness (color light output) or white brightness (white light output) in standard mode

PowerLite Pro Z9900WNL: Up to 4600 (one lamp) or 9200 (two lamps) lumens of color brightness (color light output) or white brightness (white light output) in standard mode

PowerLite Pro Z10000UNL/Z10005UNL: Up to 5000 (one lamp) or 10000 (two lamps) lumens color brightness (color light output) or white brightness (white light output) in standard mode

PowerLite Pro Z11000WNL/Z11005NL: Up to 5500 (one lamp) or 11000 (two lamps) lumens color brightness (color light output) or white brightness (white light output) in standard mode

**Note:** Color brightness (color light output) and white brightness (white light output) will vary depending on usage conditions. Color light output measured in accordance with IDMS 15.4; white light output measured in accordance with ISO 21118.

- Native resolution of:

PowerLite Pro Z9870NL/Z11005NL: 1024 × 768 pixels (XGA)

PowerLite Pro Z9800WNL/Z9900WNL/Z11000WNL: 1200 × 800 pixels (WXGA)

PowerLite Pro Z9750UNL/Z9870UNL/Z10000UNL/Z10005UNL: 1920 × 1200 pixels (WUXGA)

### **Flexible connectivity**

- Wired and wireless network support for projection, monitoring, and control via remote network computer
- Variety of connection methods to a computer or video device including HDMI, BNC, DVI-D, HDBaseT, and SDI (PowerLite Pro Z9870UNL/Z10000UNL/Z10005UNL)
- Ports for connecting an external monitor and external speakers

### **Easy-to-use setup and operation features**

- Interchangeable bayonet lens options available
- Project images side by side from two separate input sources
- Create one large seamless display when projecting from multiple projectors using Edge Blending
- Epson's Instant Off and Direct Power On features for quick setup and shut down
- Support for Crestron RoomView network monitoring systems
- Network message broadcast system to project timely messages to all networked projectors (Windows only)

**Note:** The PowerLite Pro projector with the standard zoom lens (ELPLS04) is shown in most illustrations in this manual, unless noted otherwise.

[Product Box Contents](#)

[Additional Components](#)

[Optional Equipment and Replacement Parts](#)

[Warranty and Registration Information](#)

**Parent topic:** [Introduction to Your Projector](#)

**Related concepts**

[Projector Part Locations](#)

## **Product Box Contents**

Save all the packaging in case you need to ship the projector. Always use the original packaging (or equivalent) when shipping.

Make sure your projector box included all of these parts:

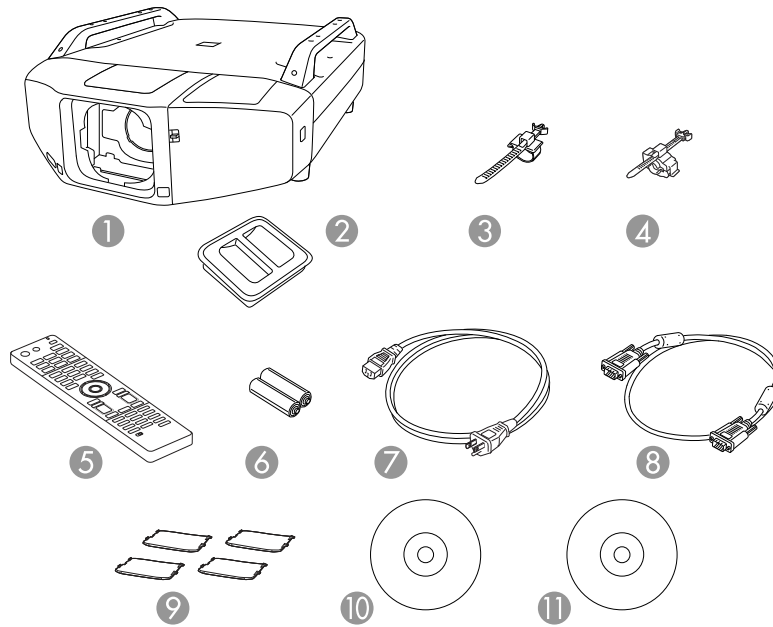

- 1 Projector
- 2 Lens unit cap
- 3 Power cord clip
- 4 HDMI cable clip
- 5 Remote control
- 6 Remote control batteries (two AA alkaline)
- 7 Power cord
- 8 VGA computer cable
- 9 Foot covers
- 10 Projector manuals and software links CD
- 11 Projector software CD

**Parent topic:** [Projector Features](#)

**Related concepts**

[Projector Connections](#)

## Additional Components

Depending on how you plan to use the projector, you may need to obtain the following additional components:

- To connect a computer through its VGA port to the projector's BNC ports, you need a VGA-to-5-BNC cable or adapter. You can purchase one from Epson or an authorized Epson reseller.
- To receive a composite video signal, you need a BNC-style, composite video cable. See your local computer or electronics dealer for purchase information.
- To receive an S-Video signal, you need an S-Video cable compatible with your device. See your local computer or electronics dealer for purchase information.
- To receive a component video signal, you need a component-to-BNC or a D-sub, 15-pin, component-to-VGA video cable or adapter. You can purchase one from Epson or an authorized Epson reseller.
- To receive an HDMI signal, you need a compatible HDMI cable. You can purchase one from Epson or an authorized Epson reseller.
- To receive a DVI-D signal, you need a compatible DVI-D cable.
- To receive an HDBaseT signal, you need a compatible 100Base-TX LAN cable.
- To receive an SDI signal (PowerLite Pro Z9870UNL/Z10000UNL/Z10005UNL), you need a compatible BNC video cable.
- To connect a Mac that includes only a Mini DisplayPort, Thunderbolt port, or Mini-DVI port for video output, you need to obtain an adapter. Contact Apple for compatible adapter options.

**Parent topic:** [Projector Features](#)

## Optional Equipment and Replacement Parts

You can purchase screens, other optional accessories, and replacement parts from an Epson authorized reseller. To find the nearest reseller, call 800-GO-EPSON (800-463-7766). Or you can purchase online at [epsonstore.com](http://epsonstore.com) (U.S. sales) or [epson.ca](http://epson.ca) (Canadian sales).

Epson offers the following optional accessories and replacement parts for your projector:

Option or part	Part number
Genuine Epson replacement lamp (single) (ELPLP81)	V13H010L81

<b>Option or part</b>	<b>Part number</b>
Genuine Epson replacement lamp (dual) (ELPLP82)	V13H010L82
Genuine Epson replacement portrait lamp (single) (ELPLP83)	V13H010L83
Genuine Epson replacement portrait lamp (dual) (ELPLP84)	V13H010L84
Air filter (ELPAF46)	V13H134A46
Quick wireless connection USB key (ELPAP09)	V12H005M09
Wireless LAN module (ELPAP07)	V12H418P12
HDBaseT transmitter (ELPHD01)	V12H547020
Installation frame (ELPMB44)	V12H681010
Replacement remote control	2157388
Remote control cable set (ELPKC28)	V12H005C28
Epson DC-11 document camera (ELPDC11)	V12H377020
Epson DC-20 document camera (ELPDC20)	V12H500020
Wireless IR mouse receiver for remote control (ELPST16)	V12H007T16
Polarizer Kit for 3D Stacking	ELPPL01
Passive 3D glasses (adult) (ELPGS02A)	V12H541A20
Passive 3D glasses (children) (ELPGS02B)	V12H541B20
Flush ceiling mount bracket (ELPMB25)	V12H003B25
Mount bracket with extended pipe (ELPMB26)	V12H003B26
False ceiling plate kit	ELPMBP02
Component-to-VGA video cable (ELPKC19)	V12H005C19
VGA video cable 6 feet (1.8 m) length	F3H982-06
VGA video cable 10 feet (3.0 m) length	F3H982-10
VGA video cable 25 feet (7.6 m) length	F3H982-25
HDMI audio video cable 3 feet (0.9 m) length	AV22300-03
HDMI audio video cable 6 feet (1.8 m) length	AV22300-06
HDMI audio video cable 12 feet (3.6 m) length	AV22300-12



Option or part	Part number
Short throw zoom lens (ELPLU02)	V12H004U02
Rear-projection wide lens (ELPLR04)	V12H004R04
Standard zoom lens (ELPLS04)	V12H004S04
Middle-throw zoom lens #1 (ELPLM06)	V12H004M06
Middle-throw zoom lens #2 (ELPLM07)	V12H004M07
Long-throw zoom lens (ELPLL07)	V12H004L07
Active speakers (ELPSP02)	V12H467020
PixiePlus control system for Epson projectors	ELPSP10
Duet ultra portable projector screen	ELPSC80
60" portable roll screen (4:3)	ELPSC27
80" portable roll screen (4:3)	ELPSC28
100" portable roll screen (4:3)	ELPSC29
1-Year Exchange - Extended Service Plan	EPPEXPC1
2-Year Exchange - Extended Service Plan	EPPEXPC2

**Parent topic:** [Projector Features](#)

## Warranty and Registration Information

Your projector comes with a basic warranty that lets you project with confidence. For details, see the warranty that came with your projector.

In addition, Epson offers free Extra Care Road Service. In the unlikely event of an equipment failure, you won't have to wait for your unit to be repaired. Instead, Epson will ship you a replacement unit anywhere in the United States, Canada, or Puerto Rico. See the Extra Care Road Service brochure for details.

Register your product online using the projector CD or at this site: [epson.com/webreg](http://epson.com/webreg).

Registering also lets you receive special updates on new accessories, products, and services.

**Parent topic:** [Projector Features](#)

## Notations Used in the Documentation

Follow the guidelines in these notations as you read your documentation:

- **Warnings** must be followed carefully to avoid bodily injury.
- **Cautions** must be observed to avoid damage to your equipment.
- **Notes** contain important information about your projector.
- **Tips** contain additional projection information.

**Parent topic:** [Introduction to Your Projector](#)

## Where to Go for Additional Information

Need quick help on using your projector? Here's where to look for help:

- Built-in help system

Press the **Help** button on the remote control to get quick solutions to common problems.

- [epson.com/support](http://epson.com/support) (U.S) or [epson.ca/support](http://epson.ca/support) (Canada)

View FAQs (frequently asked questions) and e-mail your questions to Epson technical support 24 hours a day.

- For detailed instructions on using your projector in a network environment, see the *EasyMP Network Projection Operation Guide*.
- For detailed instructions on monitoring your projector in a network environment (Windows only), see the *EasyMP Monitor Operation Guide*.
- If you still need help after checking this manual and the sources listed above, you can use the Epson PrivateLine Support service to get help fast. For details, see "Where to Get Help".

**Parent topic:** [Introduction to Your Projector](#)

### Related references

[Where to Get Help](#)

## Projector Part Locations

Check the projector part illustrations to learn about the parts on your projector.

[Projector Parts - Front/Top](#)

[Projector Parts - Rear](#)

[Projector Parts - Interface Ports](#)

- Projector Parts - Base
- Projector Parts - Control Panel
- Projector Parts - Remote Control

Parent topic: Introduction to Your Projector

## Projector Parts - Front/Top

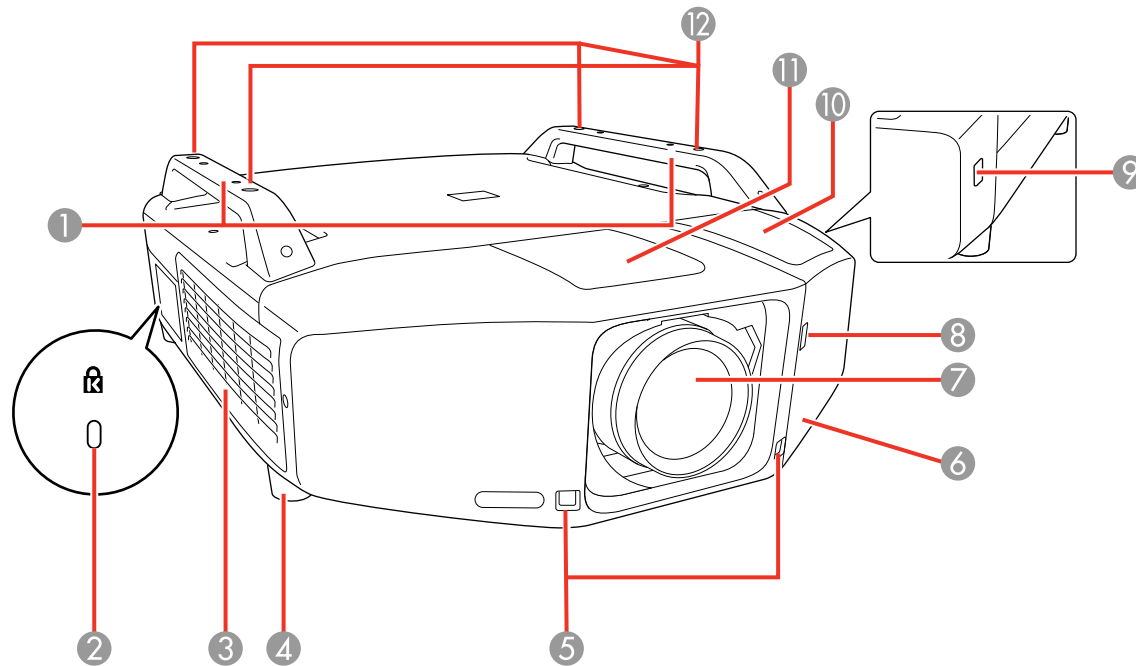

- 1 Handles
- 2 Kensington security slot
- 3 Air filter/intake vent
- 4 Front feet
- 5 Remote control receivers
- 6 Interface cover

- 7 Projection lens
- 8 Interface cover latch
- 9 Interface cover button
- 10 Cable cover
- 11 Lens cover
- 12 Ceiling mount holes

Parent topic: [Projector Part Locations](#)

## Projector Parts - Rear

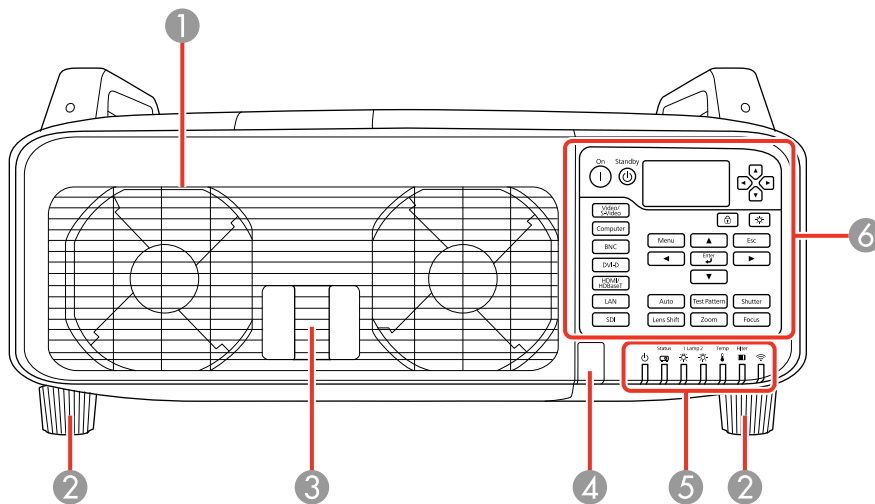

- 1 Air exhaust vent/lamp cover
- 2 Rear feet
- 3 Lamp cover latch
- 4 Remote receiver
- 5 Projector status lights
- 6 Control panel

## Projector Parts - Interface Ports

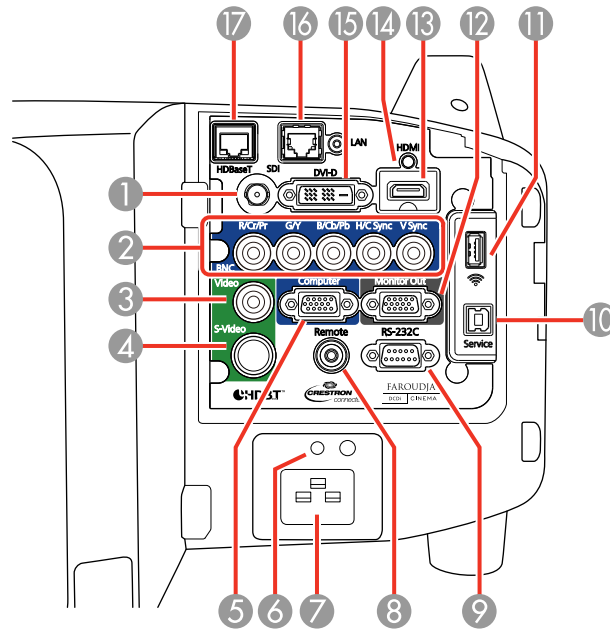

- 1 **SDI** port (PowerLite Pro Z9870UNL/Z10000UNL/Z10005UNL)
- 2 **BNC** ports
- 3 **Video** port
- 4 **S-Video** port
- 5 **Computer** port
- 6 Power cord clip slot
- 7 Power inlet
- 8 **Remote** port
- 9 **RS-232C** port
- 10 **Service** port

- 11 Wireless LAN module port
- 12 **Monitor Out** port
- 13 **HDMI** port
- 14 HDMI cable clip slot
- 15 **DVI-D** port
- 16 Network **LAN** port
- 17 **HDBaseT** port

Parent topic: [Projector Part Locations](#)

## Projector Parts - Base

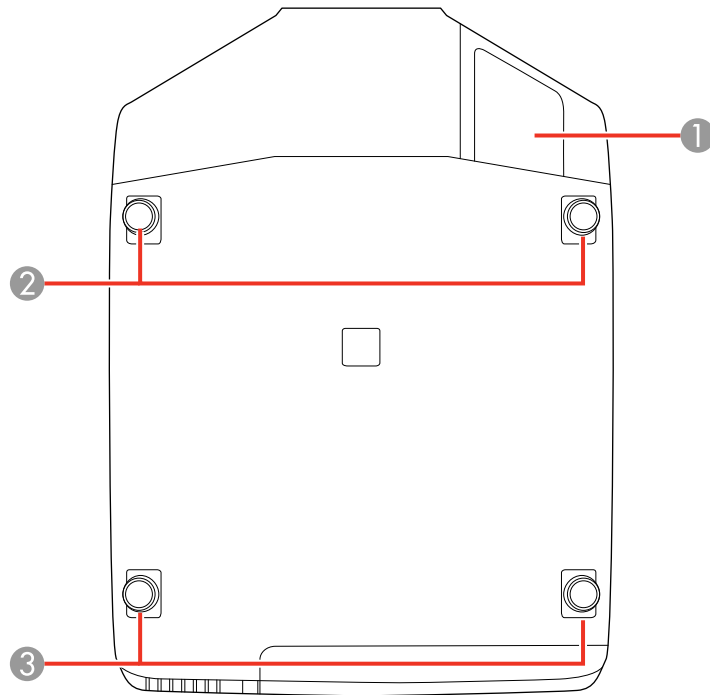

- 1 Cable wiring slot

- 2 Front feet
- 3 Rear feet

Parent topic: [Projector Part Locations](#)

## Projector Parts - Control Panel

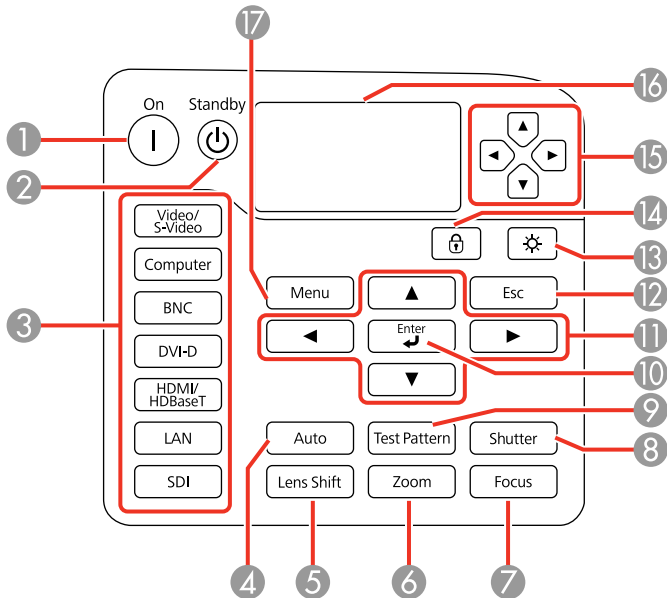

- 1 **On** button (turns power on)
- 2 **Standby** button (turns power off)
- 3 Source buttons (change input source; some buttons may not function depending on the model)
- 4 **Auto** button (automatically adjusts position, tracking, and sync settings when projecting analog RGB signals from the **Computer** or **BNC** ports)
- 5 **Lens Shift** button (adjusts the lens position)
- 6 **Zoom** button (zooms into the image)
- 7 **Focus** button (focuses the image)

- 8 **Shutter** button (turns signal on or off temporarily)
- 9 **Test Pattern** button (displays a test pattern)
- 10 **Enter** button (selects options and controls wireless mouse functions)
- 11 Arrow buttons (move through on-screen options and control wireless mouse functions; adjust focus, zoom, and lens shift)
- 12 **Esc** button (cancels/exits functions and controls wireless mouse functions)
- 13 Light button (lights up the buttons temporarily)
- 14 Lock button (displays the Control Panel Lock screen)
- 15 Arrow buttons (select status information settings)
- 16 Status display (displays projector status information)
- 17 **Menu** button (accesses projector menu system)

**Parent topic:** [Projector Part Locations](#)

**Related concepts**

[Projector Status Display](#)

**Related references**

[Projector Light Status](#)



# Projector Parts - Remote Control

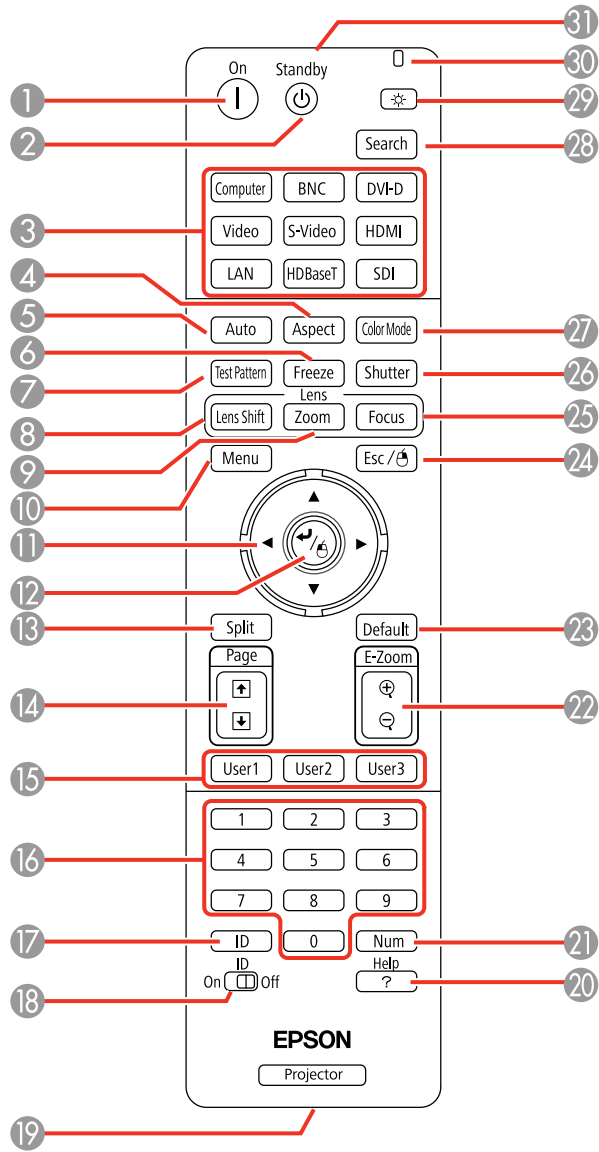

- 1 **On** button (turns power on)
- 2 **Standby** button (turns power off)
- 3 Source buttons (change input source; some buttons may not function depending on the model)
- 4 **Aspect** button (selects the image aspect ratio)
- 5 **Auto** button (automatically adjusts position, tracking, and sync settings when projecting analog RGB signals from the **Computer** or **BNC** ports)
- 6 **Freeze** button (stops video action)
- 7 **Test Pattern** button (displays a test pattern)
- 8 **Lens Shift** button (adjusts the lens position)
- 9 **Zoom** button (zooms into the image)
- 10 **Menu** button (accesses projector menu system)
- 11 Arrow buttons (move through on-screen options and control wireless mouse functions; adjust focus, zoom, and lens shift)
- 12 Enter button (selects options and controls wireless mouse functions)
- 13 **Split** button (splits the screen)
- 14 **Page** up/down buttons (scroll through image files when projecting from a computer over a network connection)
- 15 **User1**, **User2**, and **User3** buttons (customizable for different functions)
- 16 Numeric buttons (enter numbers)
- 17 **ID** button (hold down to use numeric buttons to select a projector)
- 18 **ID** switch (enables or disables ID settings)
- 19 Remote port (connects to a remote control cable)
- 20 **Help** button (accesses projector help information)
- 21 **Num** button (when held down, switches numeric buttons to number function)
- 22 **E-Zoom +/-** buttons (zoom into and out of the image)
- 23 **Default** button (resets settings to their default values in the projector menu system)
- 24 **Esc** button (cancels/exits functions and controls wireless mouse functions)
- 25 **Focus** button (focuses the image)

- 26 **Shutter** button (turns signal on or off temporarily)
- 27 **Color Mode** button (selects display modes)
- 28 **Search** button (searches for connected sources)
- 29 Light button (lights up the buttons temporarily)
- 30 Indicator light (lights up when the remote control is in use)
- 31 Remote control signal emitter (emits remote control signals)

**Parent topic:** [Projector Part Locations](#)

---

# Setting Up the Projector

Follow the instructions in these sections to set up your projector for use.

[Projector Placement](#)

[Removing and Attaching the Interface Cover](#)

[Projector Connections](#)

[Attaching and Removing a Lens](#)

[Attaching and Removing the Cable Clips](#)

[Installing Batteries in the Remote Control](#)

## Projector Placement

You can place the projector on almost any flat surface to project an image.

You can also install the projector in a ceiling mount if you want to use it in a fixed location.

Keep these considerations in mind as you select a projector location:

- Place the projector on a sturdy, level surface or install it using a compatible mount.
- Leave plenty of space around and under the projector for ventilation, and do not place it on top of or next to anything that could block the vents.
- Position the projector within reach of a grounded electrical outlet or extension cord.

[Projector Setup and Installation Options](#)

[Projection Distance](#)

**Parent topic:** [Setting Up the Projector](#)

## Projector Setup and Installation Options

You can set up or install your projector in the following ways:

Front

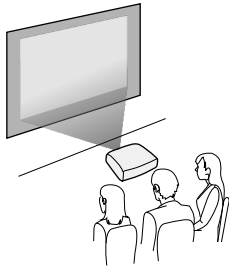

Rear

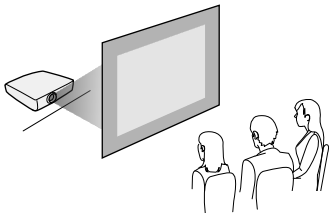

Front/Ceiling mounted

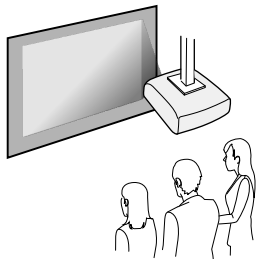

Rear/Ceiling mounted

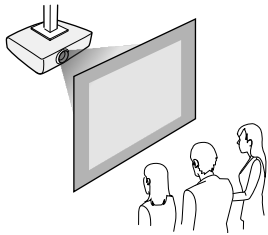

**Note:** Be sure to leave at least 20 inches (50 cm) of space in front of the air exhaust and intake vents and, when setting up multiple projectors, 20 inches (50 cm) of space between the projectors.

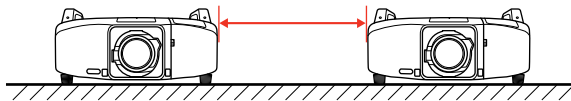
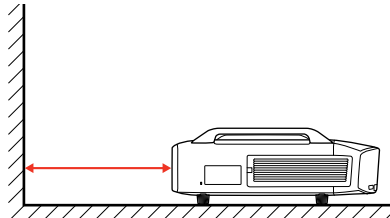
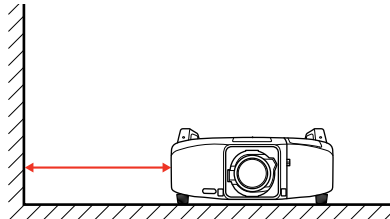

If you mount the projector for standard lamp use, you can tilt it at the following angles:

- **Vertically:** Any angle up to  $\pm 100^\circ$ .
- **Horizontally:** Within the range of  $\pm 5^\circ$ .

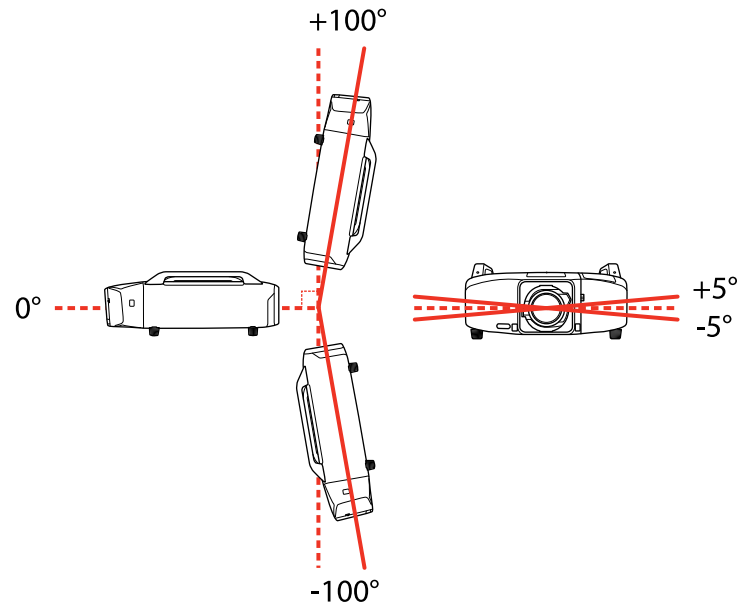

If you mount the projector for portrait lamp use, you can tilt it at the following angles:

- **Vertically:** Any angle up to  $\pm 10^\circ$ .
- **Horizontally:** Within the range of up to  $\pm 10^\circ$ .

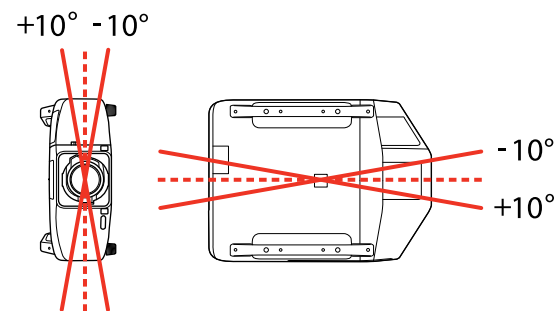

**Note:** The optional installation frame (ELPMB44) and portrait lamps (ELPLP83/ELPLP84) are required when using portrait projection. Be sure to mount the projector with the air intake vent facing down and at least 4 inches (10 cm) of space between the projector and the mounting surface as shown.

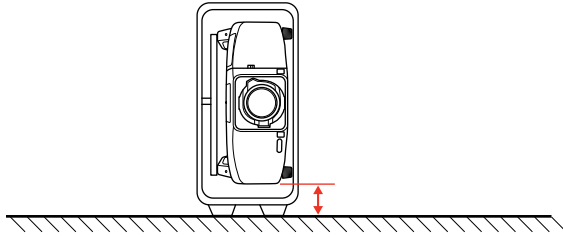

If you project from the ceiling, remove the projector's feet and attach the foot covers as shown.

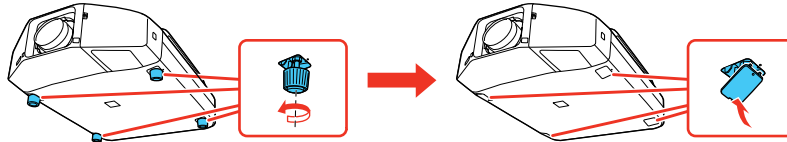

**Note:** Do not remove the projector's handles.



Set the **Direction** setting in the Extended menu to one of the following settings so that operations on the screen match the control panel button commands.

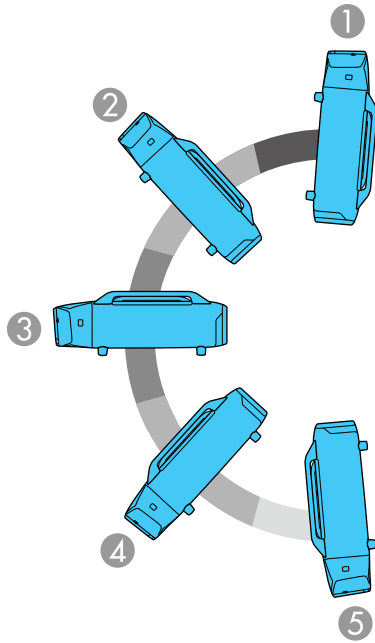

- 1 **Pointing Up**
- 2 **Angled Up**
- 3 **Normal**
- 4 **Angled Down**
- 5 **Pointing Down**

**Parent topic:** [Projector Placement](#)

**Related references**

[Projector Setup Settings - Extended Menu](#)

## Projection Distance

The distance at which you place the projector from the screen determines the approximate size of the image. The image size increases the farther the projector is from the screen, but can vary depending on the zoom factor, aspect ratio, and other settings.

Use the tables here to determine approximately how far to place the projector from the screen based on the size of the projected image. (Conversion figures may have been rounded up or down.) You can also use the projector Throw Distance Calculator at [epson.com/support](http://epson.com/support) (U.S.) or [epson.ca/support](http://epson.ca/support) (Canada).

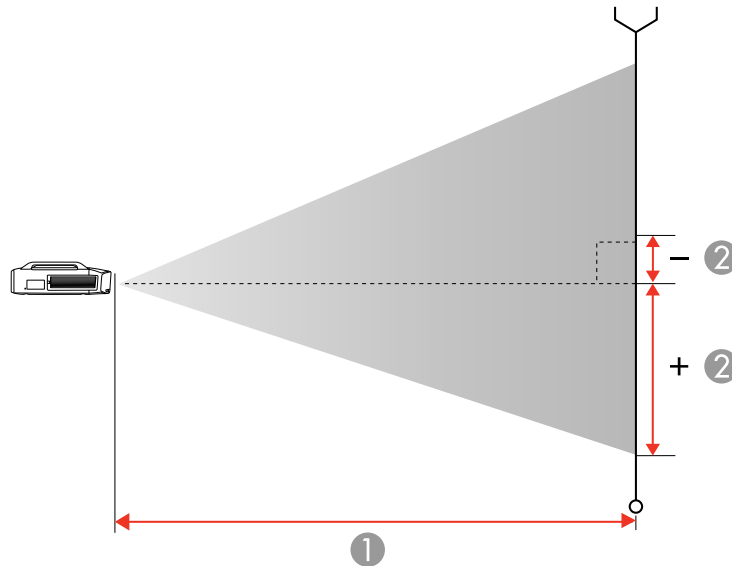

- 1 Projection distance
- 2 Distance from the center of the lens to the base of the image (varies depending on vertical lens shift)

**PowerLite Pro Z9800WNL/Z9900WNL/Z11000WNL/Z9750UNL/Z9870UNL/Z10000UNL/Z10005UNL  
Standard Zoom Lens - 4:3 Aspect Ratio**

<b>Screen or image size</b>	<b>Projection distance Wide to Tele</b>	<b>Vertical lens shift Top to Bottom</b>
53 inches	78 to 128 inches (199 to 326 cm)	-3 to 35 inches (-8 to 89 cm)
80 inches	119 to 195 inches (304 to 497 cm)	-5 to 52 inches (-12 to 134 cm)
100 inches	150 to 245 inches (383 to 623 cm)	-6 to 66 inches (-15 to 168 cm)
150 inches	227 to 369 inches (578 to 938 cm)	-9 to 99 inches (-23 to 252 cm)

**PowerLite Pro Z9870NL/Z11005NL**

**Standard Zoom Lens - 4:3 Aspect Ratio**

<b>Screen or image size</b>	<b>Projection distance Wide to Tele</b>	<b>Vertical lens shift Top to Bottom</b>
60 inches	76 to 126 inches (194 to 319 cm)	-2 to 38 inches (-5 to 97 cm)
80 inches	103 to 168 inches (261 to 428 cm)	-3 to 50 inches (-7 to 129 cm)
100 inches	129 to 211 inches (329 to 537 cm)	-3 to 63 inches (-8 to 161 cm)
120 inches	156 to 254 inches (396 to 646 cm)	-4 to 76 inches (-10 to 193 cm)

**PowerLite Pro Z9800WNL/Z9900WNL/Z11000WNL/Z9750UNL/Z9870UNL/Z10000UNL/Z10005UNL**

**Standard Zoom Lens - 16:9 Aspect Ratio**

<b>Screen or image size</b>	<b>Projection distance Wide to Tele</b>	<b>Vertical lens shift Top to Bottom</b>
60 inches	81 to 132 inches (205 to 336 cm)	-5 to 34 inches (-13 to 87 cm)
80 inches	108 to 177 inches (276 to 450 cm)	-7 to 46 inches (-17 to 116 cm)
100 inches	136 to 222 inches (347 to 565 cm)	-8 to 57 inches (-21 to 145 cm)
150 inches	206 to 335 inches (524 to 851 cm)	-12 to 86 inches (-31 to 218 cm)

**PowerLite Pro Z9870NL/Z11005NL**

**Standard Zoom Lens - 16:9 Aspect Ratio**

<b>Screen or image size</b>	<b>Projection distance Wide to Tele</b>	<b>Vertical lens shift Top to Bottom</b>
56 inches	78 to 128 inches (197 to 324 cm)	-6 to 34 inches (-17 to 87 cm)
80 inches	112 to 184 inches (285 to 467 cm)	-9 to 48 inches (-24 to 124 cm)
100 inches	141 to 231 inches (359 to 586 cm)	-12 to 60 inches (-30 to 155 cm)
120 inches	213 to 347 inches (542 to 882 cm)	-17 to 91 inches (-45 to 232 cm)

**PowerLite Pro Z9800WNL/Z9900WNL/Z11000WNL/Z9750UNL/Z9870UNL/Z10000UNL/Z10005UNL  
Standard Zoom Lens - 16:10 Aspect Ratio**

<b>Screen or image size</b>	<b>Projection distance Wide to Tele</b>	<b>Vertical lens shift Top to Bottom</b>
60 inches	78 to 128 inches (199 to 326 cm)	-3 to 35 inches (-8 to 89 cm)
80 inches	105 to 172 inches (268 to 438 cm)	-4 to 47 inches (-11 to 119 cm)
100 inches	133 to 216 inches (337 to 549 cm)	-5 to 58 inches (-14 to 148 cm)
150 inches	200 to 326 inches (509 to 828 cm)	-8 to 87 inches (-20 to 222 cm)

**PowerLite Pro Z9870NL/Z11005NL  
Standard Zoom Lens - 16:10 Aspect Ratio**

<b>Screen or image size</b>	<b>Projection distance Wide to Tele</b>	<b>Vertical lens shift Top to Bottom</b>
57 inches	77 to 126 inches (195 to 321 cm)	-5 to 35 inches (-13 to 90 cm)
80 inches	109 to 179 inches (277 to 454 cm)	-7 to 49 inches (-18 to 126 cm)
100 inches	137 to 224 inches (349 to 569 cm)	-8 to 61 inches (-22 to 157 cm)
150 inches	208 to 338 inches (527 to 858 cm)	-13 to 92 inches (-34 to 236 cm)

Parent topic: [Projector Placement](#)

## Removing and Attaching the Interface Cover

Remove the interface cover before installing the projector so that it is easier to connect the cables after installation.

1. Push up and hold the interface cover latch while pressing the button on the side as shown. Pull the interface cover straight off the projector.

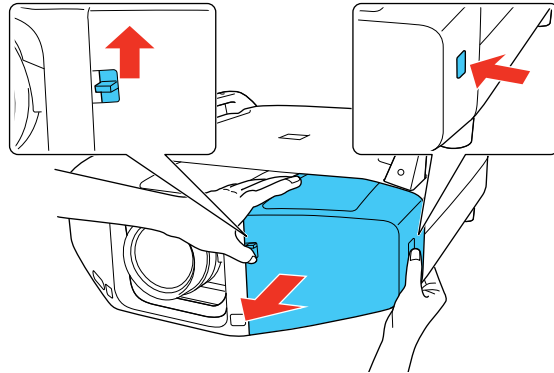

2. If you will route the connected cables through the top of the projector, remove the top panel from the interface cover. If you will route the connected cables through the bottom, remove the bottom panel.

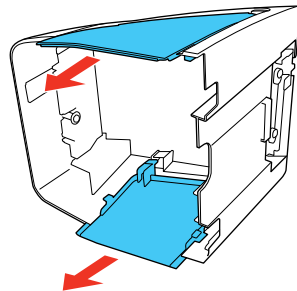

3. Align the interface cover with the guides on the projector and slide it until it clicks into place.

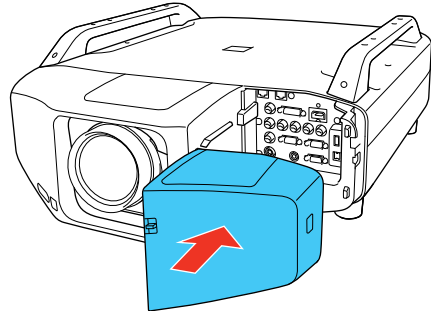

**Parent topic:** [Setting Up the Projector](#)

## Projector Connections

You can connect the projector to a variety of computer and video sources to display presentations, movies, or other images.

- Connect any type of computer that has a standard video output (monitor) port, DVI-D, or HDMI port.
- For video projection, connect devices such as DVD players, gaming consoles, digital cameras, tablets, and smartphones with compatible video output ports.

**Caution:** If you will use the projector at altitudes above 4921 feet (1500 m), turn on **High Altitude Mode** to ensure the projector's internal temperature is regulated properly.

[Connecting to Computer Sources](#)

[Connecting to Video Sources](#)

[Connecting to an HDBaseT Transmitter](#)

[Connecting to an External Computer Monitor](#)

**Parent topic:** [Setting Up the Projector](#)

### Related references

[Projector Setup Settings - Extended Menu](#)

[Product Box Contents](#)

## Connecting to Computer Sources

Follow the instructions in these sections to connect a computer to the projector.

[Connecting to a Computer for VGA Video](#)

[Connecting to a Computer for HDMI Video](#)

[Connecting to a Computer for DVI-D Video](#)

[Connecting to a Computer for 5 BNC Video](#)

**Parent topic:** [Projector Connections](#)

### Connecting to a Computer for VGA Video

You can connect the projector to your computer using a VGA computer cable.

**Note:** To connect a Mac that includes only a Mini DisplayPort, Thunderbolt port, or Mini-DVI port for video output, you need to obtain an adapter that allows you to connect to the projector's VGA video port. Contact Apple for compatible adapter options.

1. If necessary, disconnect your computer's monitor cable.
2. Connect the VGA computer cable to your computer's monitor port.
3. Connect the other end to a **Computer** port on the projector.

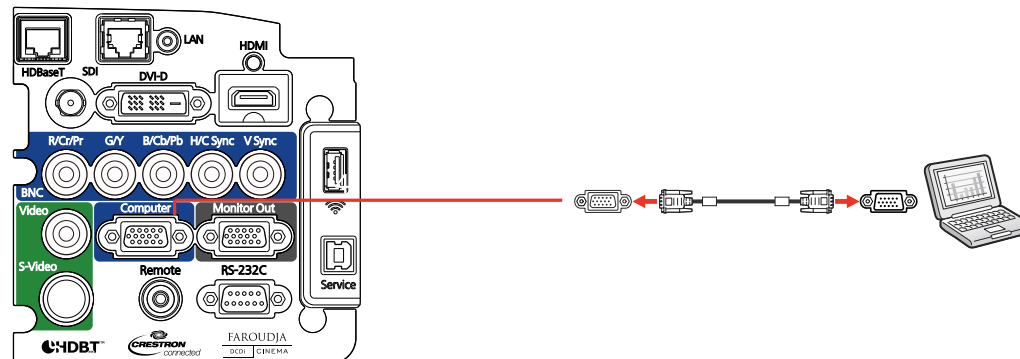

4. Tighten the screws on the VGA connector.

**Parent topic:** [Connecting to Computer Sources](#)

## Connecting to a Computer for HDMI Video

If your computer has an HDMI port, you can connect it to the projector using an optional HDMI cable.

**Note:** To connect a Mac that includes only a Mini DisplayPort, Thunderbolt port, or Mini-DVI port for video output, you need to obtain an adapter that allows you to connect to the projector's **HDMI** port.

1. Connect the HDMI cable to your computer's HDMI output port.
2. Connect the other end to the projector's **HDMI** port.

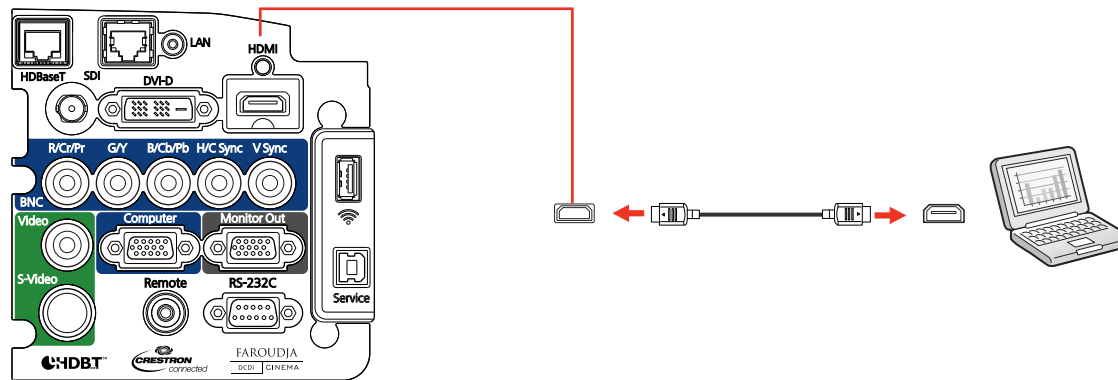

**Parent topic:** [Connecting to Computer Sources](#)

## Connecting to a Computer for DVI-D Video

If your computer has a DVI-D connector, you can connect it to the projector using an optional DVI-D cable.

1. Connect the DVI-D cable to your computer's DVI-D connector.



2. Connect the other end to the projector's **DVI-D** connector.

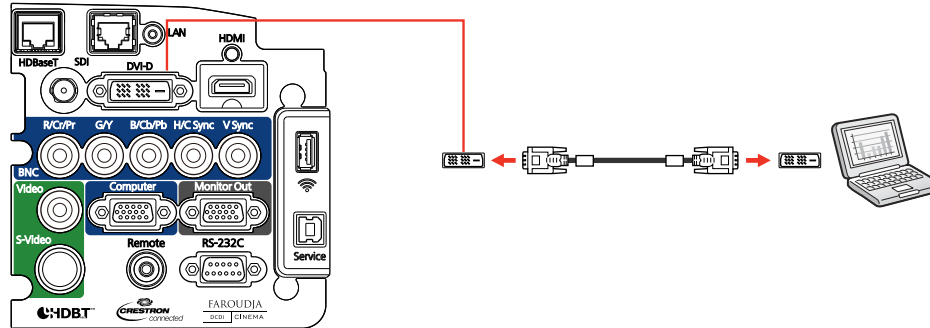

Parent topic: [Connecting to Computer Sources](#)

### Connecting to a Computer for 5 BNC Video

You can connect the projector to your computer using an optional VGA-to-5-BNC cable.

1. Connect the VGA connector to your computer's monitor port.
2. Connect the 5 BNC connectors to the projector's **BNC** ports.

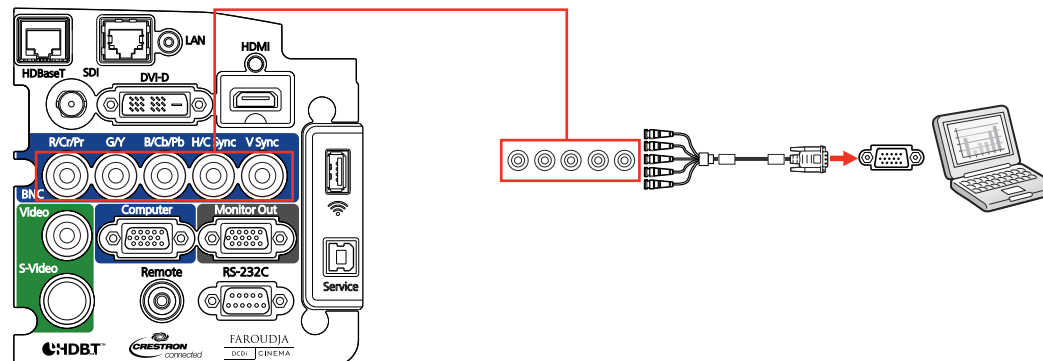

Parent topic: [Connecting to Computer Sources](#)

### Connecting to Video Sources

Follow the instructions in these sections to connect video devices to the projector.

- [Connecting to an HDMI Video Source](#)
- [Connecting to a Component-to-BNC Video Source](#)
- [Connecting to a Component Video Source](#)
- [Connecting to an S-Video Video Source](#)
- [Connecting to a Composite Video Source](#)
- [Connecting to an SDI Video Source](#)

**Parent topic:** [Projector Connections](#)

### Connecting to an HDMI Video Source

If your video source has an HDMI port, you can connect it to the projector using an optional HDMI cable. The HDMI connection provides the best image quality.

1. Connect the HDMI cable to your video source's HDMI output port.
2. Connect the other end to the projector's **HDMI** port.

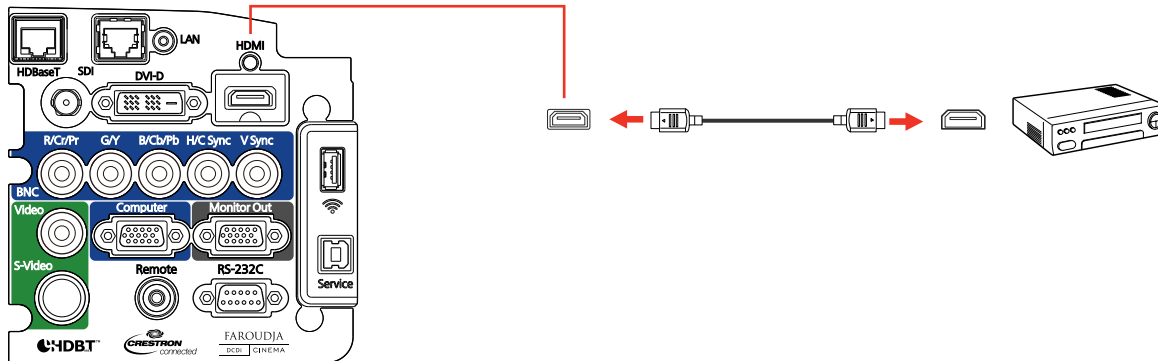

**Parent topic:** [Connecting to Video Sources](#)

#### Related tasks

[Attaching and Removing the Cable Clips](#)

### Connecting to a Component-to-BNC Video Source

If your video source has component video ports, you can connect it to the projector using an optional component-to-BNC video cable. Depending on your component ports, you may need to use an adapter cable along with a component video cable.

1. Connect the component connectors to your video source's color-coded component video output ports, usually labeled **Y, Pb, Pr** or **Y, Cb, Cr**. If you are using an adapter, connect these connectors to your component video cable.
2. Connect the BNC connectors to the projector's **R/Cr/Pr, G/Y, B/Cb/Pb** ports.

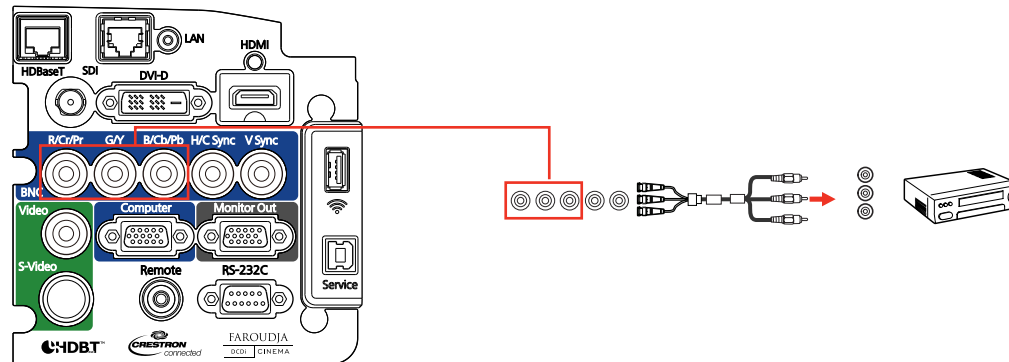

Parent topic: [Connecting to Video Sources](#)

### Connecting to a Component Video Source

If your video source has component video ports, you can connect it to the projector using an optional component-to-VGA video cable. Depending on your component ports, you may need to use an adapter cable along with a component video cable.

1. Connect the component connectors to your video source's color-coded component video output ports, usually labeled **Y, Pb, Pr** or **Y, Cb, Cr**. If you are using an adapter, connect these connectors to your component video cable.

2. Connect the VGA connector to a **Computer** port on the projector.

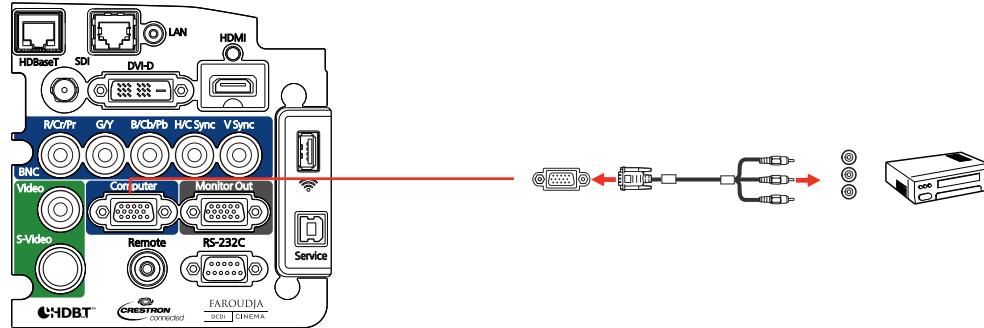

3. Tighten the screws on the VGA connector.

**Parent topic:** [Connecting to Video Sources](#)

**Related references**

[Input Signal Settings - Signal Menu](#)

### Connecting to an S-Video Video Source

If your video source has an S-Video port, you can connect it to the projector using an optional S-Video cable.

1. Connect the S-Video cable to your video source's S-Video output port.
2. Connect the other end to the projector's **S-Video** port.

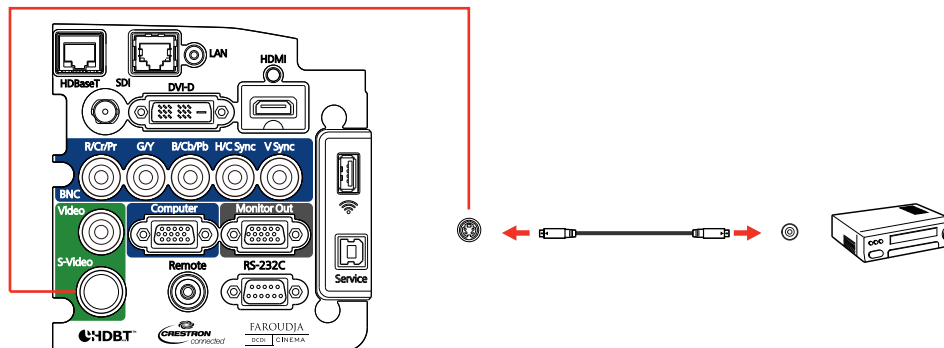

Parent topic: [Connecting to Video Sources](#)

### Connecting to a Composite Video Source

If your video source has a composite video port, you can connect it to the projector using an optional BNC-style, composite video cable.

1. Connect the cable with the yellow connector to your video source's yellow video output port.
2. Connect the other end to the projector's **Video** port.

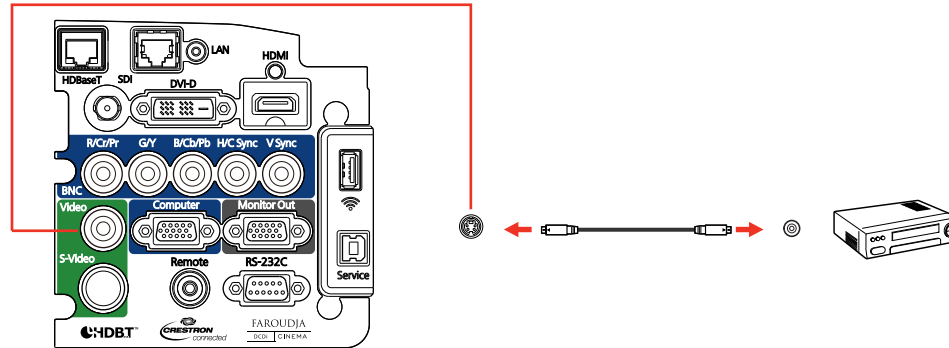

Parent topic: [Connecting to Video Sources](#)

### Connecting to an SDI Video Source

If your video source has an SDI port, you can connect it to the projector using an optional BNC video cable (PowerLite Pro Z9870UNL/Z10000UNL/Z10005UNL).

1. Connect the BNC video cable to your video source's SDI output port.

2. Connect the other end to the projector's **SDI** port.

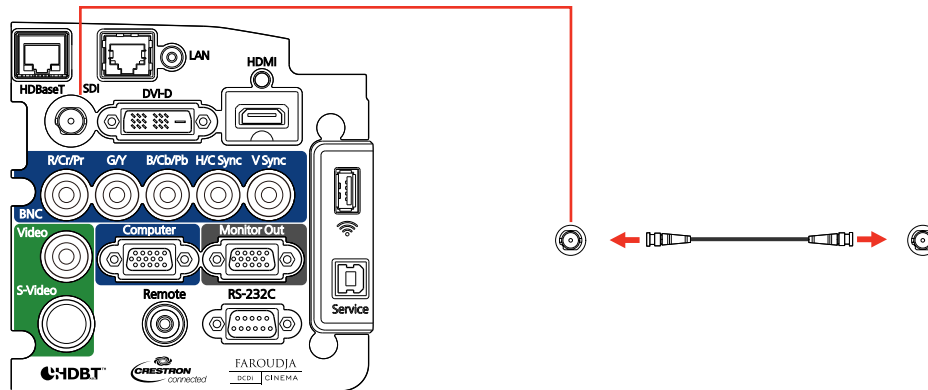

Parent topic: [Connecting to Video Sources](#)

## Connecting to an HDBaseT Transmitter

To send an HDMI or RS-232C signal over a long distance, you can connect the projector to an optional HDBaseT transmitter using a 100Base-TX network cable. This is useful when you want to send a signal to or control the projector from a remote location, such as in a hall or event site, since you can use a network cable up to 328 feet (100 m) in length. To ensure proper data transmission, use a Category 5e STP cable or better.

1. Turn off the projector and HDBaseT transmitter.

**Note:** Make sure the projector and HDBaseT transmitter are turned off when connecting or disconnecting a network cable between the two devices.

2. Connect one end of the network cable to the **HDBaseT** port on the transmitter.

3. Connect the other end to the projector's **HDBaseT** port.

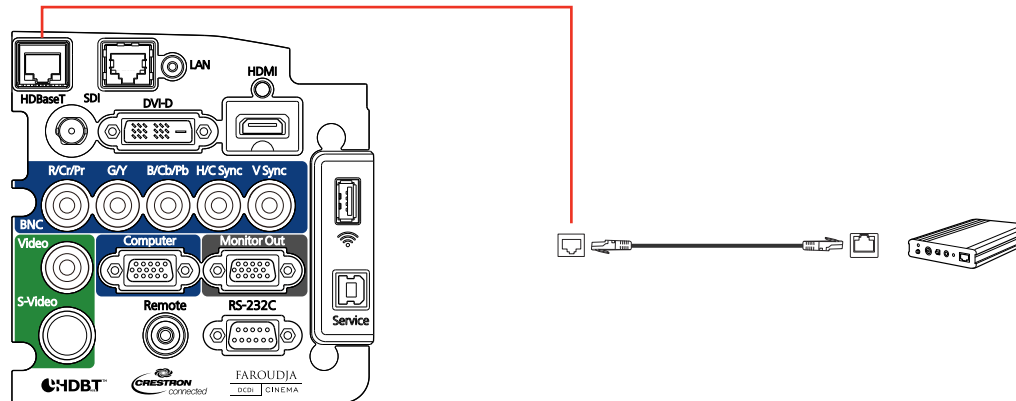

See the documentation that came with the HDBaseT transmitter for instructions on connecting it to your video device or computer.

4. Turn on the projector and HDBaseT transmitter.

**Note:** To enable communication from the Ethernet and serial ports on the transmitter, select **On** as the **Control Communications** setting in the projector's Extended menu. Turning on this setting disables the projector's **LAN**, **RS-232C**, and **Remote** ports.

**Parent topic:** [Projector Connections](#)

**Related references**

[Projector Setup Settings - Extended Menu](#)

## Connecting to an External Computer Monitor

If you connected a computer to the projector's **Computer** or **BNC** port, you can also connect an external monitor to the projector. This lets you see your presentation on the external monitor even when the projected image is not visible.

If you want to output images to an external monitor when the projector is turned off, you need to select **Communication On** as the **Standby Mode** setting and **Always On** as the **A/V Output** setting in the projector's Extended menu.

**Note:** Monitors that use a refresh rate less than 60 Hz may not be able to display images correctly.

1. Make sure your computer is connected to the projector's **Computer** or **BNC** port.
2. Connect the external monitor's cable to your projector's **Monitor Out** port.

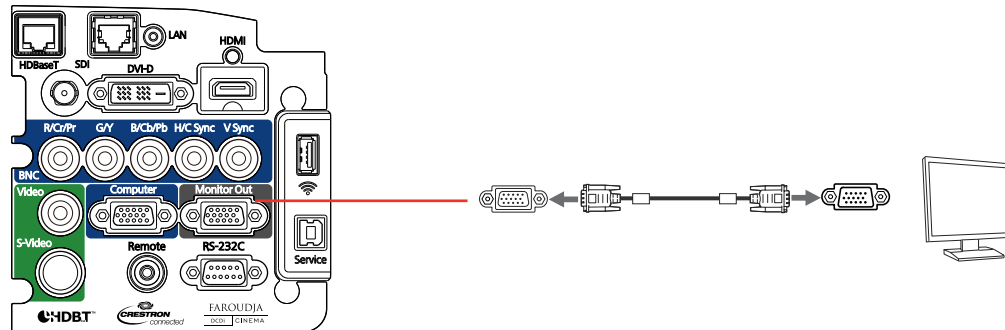

**Note:** If you do not see an image on the external monitor, you may need to change the **Monitor Out** setting in the Extended menu.

**Parent topic:** [Projector Connections](#)

**Related references**

[Projector Setup Settings - Extended Menu](#)

## Attaching and Removing a Lens

Follow the instructions in these sections to attach or remove a compatible lens.

[Removing a Lens](#)

[Attaching a Lens](#)

**Parent topic:** [Setting Up the Projector](#)

## Removing a Lens

You can remove a lens to replace it with a different lens.

**Caution:** Remove the lens only when necessary and make sure the front of the projector is not facing up when you remove the lens. This prevents dirt or dust from entering the projector and lowering the projection quality. Avoid touching the lens with your bare hands to prevent fingerprints on or damage to the lens surface.



1. Center the lens using the **Lens Shift** button.
2. Turn off the projector.
3. Press down on the lens cover and lift it off of the projector.

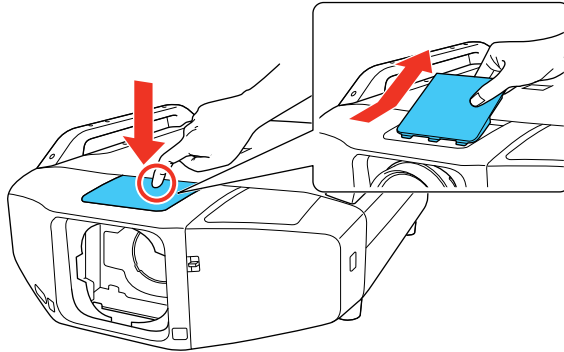

4. Hold the lens firmly as you slide the lock lever to the **Release** position (counterclockwise) until you hear it click.

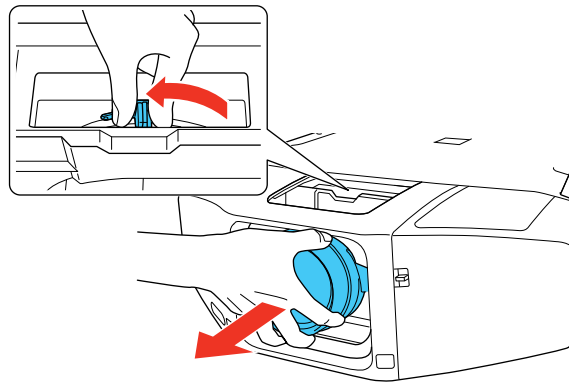

5. Gently pull the lens straight out of the projector.
- Parent topic:** [Attaching and Removing a Lens](#)

## Attaching a Lens

You can attach a compatible lens to the projector.

**Caution:** Avoid touching the lens with your bare hands to prevent fingerprints on or damage to the lens surface.

1. Press down on the lens cover and lift it off of the projector.

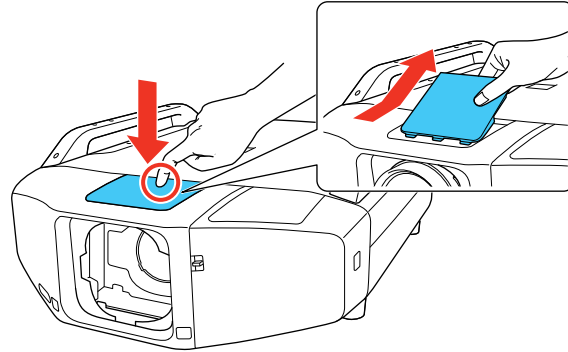

2. Slide the lock lever to the **Release** position (counterclockwise) until you hear it click.

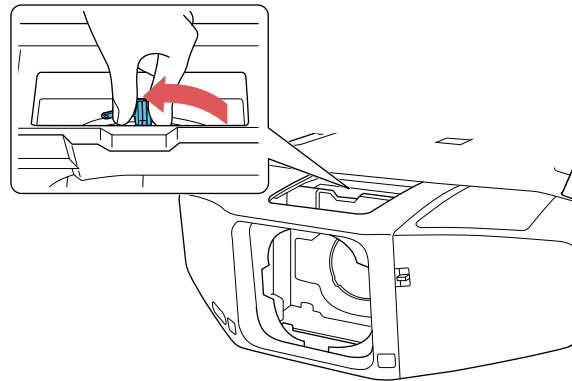

3. Insert the lens straight into the projector's lens socket with the white dot facing up.

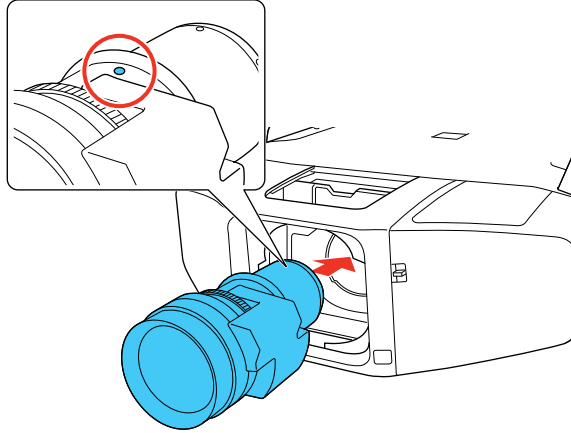

4. Hold the lens firmly and slide the lock lever to the **Lock** position (clockwise) until it locks.

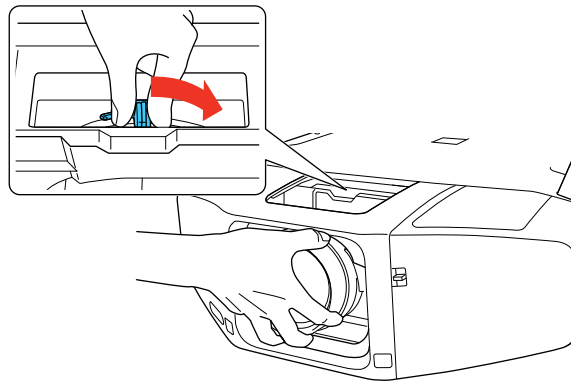

5. Replace the lens cover.

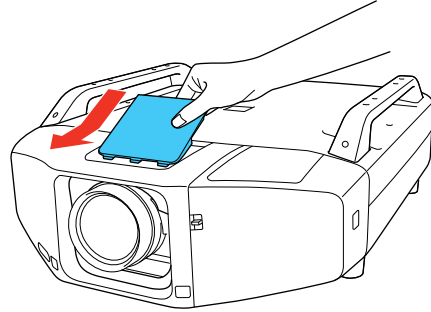

6. Set the **Lens Type** setting in the Extended menu for the type of lens you installed.

Parent topic: [Attaching and Removing a Lens](#)

## Attaching and Removing the Cable Clips

You can install the cable clips that came with your projector to provide additional support to the power cord and HDMI cable.

1. Connect the power cord and HDMI cable to the projector.
2. Insert the end of each cable clip anchor into the cable clip slot above the power inlet and **HDMI** port as shown.

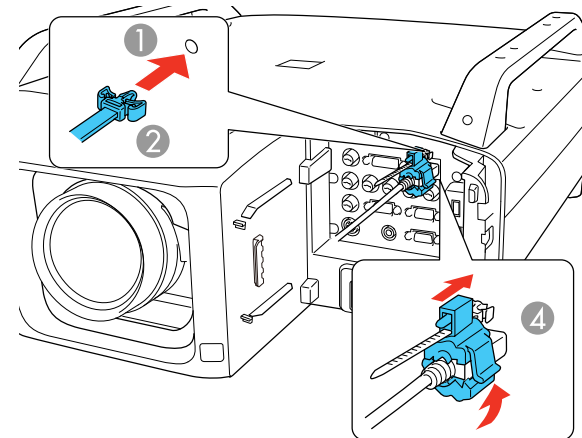
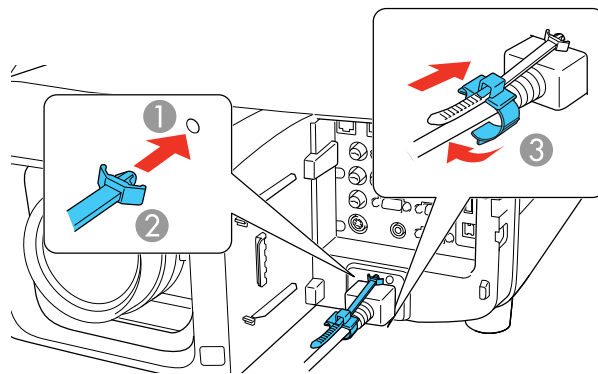

- 1 Cable clip slot
- 2 Cable clip anchor
- 3 Power cable clip
- 4 HDMI cable clip

3. Place the open cable clips around the power cord and HDMI cable, but do not lock them.
4. Slide each cable clip onto the anchors and lock the clips onto the power and HDMI anchors as shown.

To remove the cable clips, open the clips and disconnect the cables. Then pinch the sides of each cable clip anchor and carefully pull them out of the cable clip slots.

**Parent topic:** [Setting Up the Projector](#)

**Related tasks**

[Connecting to a Computer for HDMI Video](#)

[Connecting to an HDMI Video Source](#)

## Installing Batteries in the Remote Control

The remote control uses the two AA batteries that came with the projector.

**Caution:** Use only the type of batteries specified in this manual. Do not install batteries of different types, or mix new and old batteries.

1. Remove the battery cover.

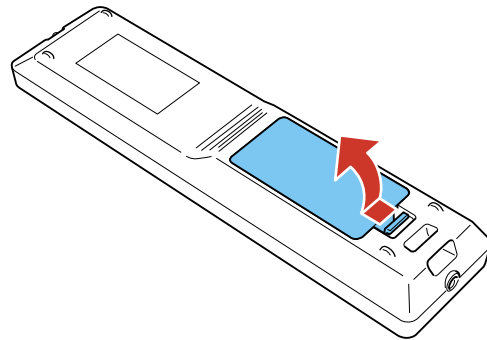

2. Insert the batteries with the + and – ends facing as shown.

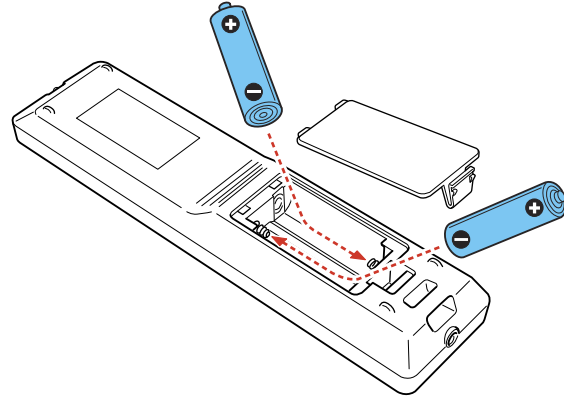

3. Replace the battery cover and press it down until it clicks into place.

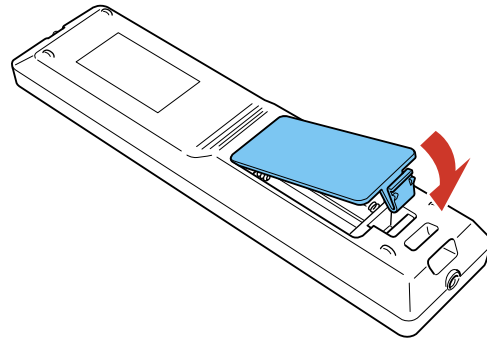

**Warning:** Dispose of used batteries according to local regulations. Do not expose batteries to heat or flame. Keep batteries out of the reach of children; they are choking hazards and are very dangerous if swallowed.

Parent topic: [Setting Up the Projector](#)

---

# Using the Projector on a Network

Follow the instructions in these sections to set up your projector for use on a network.

[Wired Network Projection](#)

[Wireless Network Projection](#)

[Setting Up Projector Network E-Mail Alerts](#)

[Setting Up Monitoring Using SNMP](#)

[Controlling a Networked Projector Using a Web Browser](#)

[Crestron RoomView Support](#)

## Wired Network Projection

You can send images to your projector through a wired network. To do this, you connect the projector to your network, and then set up your projector and computer for network projection.

After connecting and setting up the projector as described here, install the network software from the *Epson Projector Software* CD or download the software as necessary. Use the following software and documentation to set up, control, and monitor network projection:

- EasyMP Network Projection software sets up your computer for network projection. See the *EasyMP Network Projection Operation Guide* for instructions.
- EasyMP Monitor software (Windows only) lets you monitor and control your projector through the network. You can download the latest software and documentation from the Epson web site. Go to [epson.com/support](http://epson.com/support) (U.S.) or [epson.ca/support](http://epson.ca/support) (Canada) and select your projector.
- EasyMP Multi PC Projection software allows you to hold interactive meetings by projecting the computer screens of users over a network. See the *EasyMP Multi PC Projection Operation Guide* for instructions.
- EasyMP Network Updater software (Windows only) allows you to update firmware for a projector over a wired LAN. See the *EasyMP Network Updater Operation Guide* for instructions. You can download the latest software and documentation from the Epson web site. Go to [epson.com/support](http://epson.com/support) (U.S.) or [epson.ca/support](http://epson.ca/support) (Canada) and select your projector.
- Projection from iOS or Android devices using the free Epson iProjection app (if your projector is connected via a LAN cable to a network that includes a wireless access point); visit [epson.com/projectorapp](http://epson.com/projectorapp) (U.S.) or [epson.ca/projectorapp](http://epson.ca/projectorapp) (Canada) for more information.

**Note:** If your projector is connected via a LAN cable to a network that includes a wireless access point, you can connect to the projector wirelessly through the access point using the EasyMP Network Projection software.

[Connecting to a Wired Network](#)  
[Selecting Wired Network Settings](#)

**Parent topic:** [Using the Projector on a Network](#)

**Related references**

[Projector Network Settings - Network Menu](#)

## Connecting to a Wired Network

To connect the projector to a wired local area network (LAN), use a 100Base-TX or 10Base-T network cable. To ensure proper data transmission, use a Category 5e shielded cable or better.

1. Connect one end of the network cable to your network hub, switch, or router.
2. Connect the other end of the cable to the projector's **LAN** port.

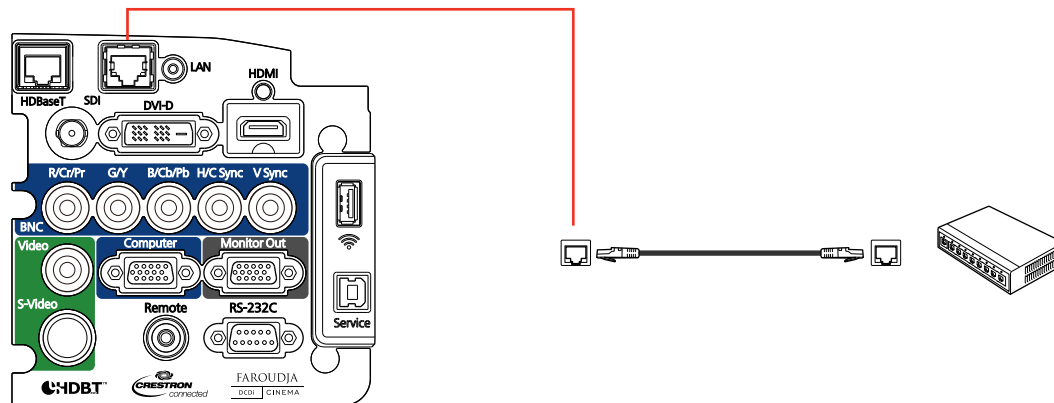

**Parent topic:** [Wired Network Projection](#)

## Selecting Wired Network Settings

Before you can project from computers on your network, you must select the network settings for the projector using its menu system.



**Note:** Make sure you already connected the projector to your wired network using the **LAN** port.

1. Turn on the projector.
2. Press the **Menu** button.
3. Select the **Network** menu and press **Enter**.

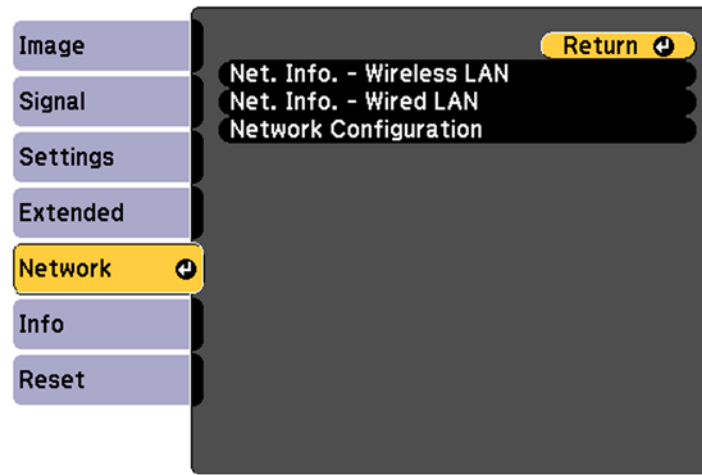

4. Select **Network Configuration** and press **Enter**.

5. Select the **Basic** menu and press **Enter**.

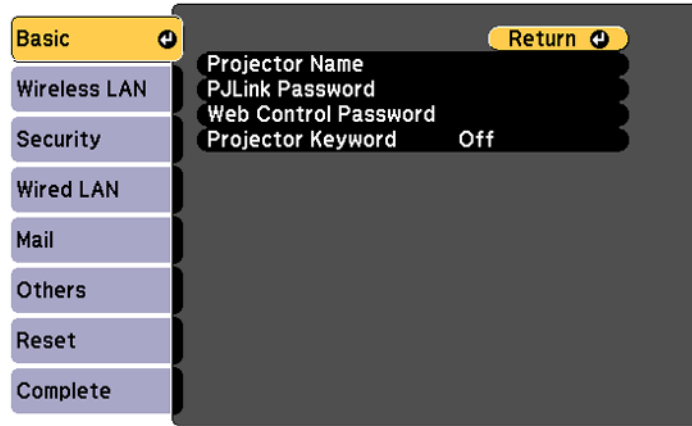

6. Select the following basic options as necessary:

- **Projector Name** lets you enter a name up to 16 alphanumeric characters long to identify the projector over the network.
- **PJLink Password** lets you enter a password up to 32 alphanumeric characters long for using the PJLink protocol for projector control.
- **Web Control Password** lets you enter a password up to 8 alphanumeric characters long for accessing the projector over the web. (Default user name is **EPSONWEB**; default password is **admin**.)
- **Projector Keyword** lets you turn on a security password to prevent access to the projector by anyone not in the room with it. You must enter a displayed, randomized keyword from a computer using the EasyMP Network Projection software to access the projector.

**Note:** Use the displayed keyboard to enter the name, passwords and keyword. Press the arrow buttons on the remote control to highlight characters and press **Enter** to select them.

7. Select the **Wired LAN** menu and press **Enter**.

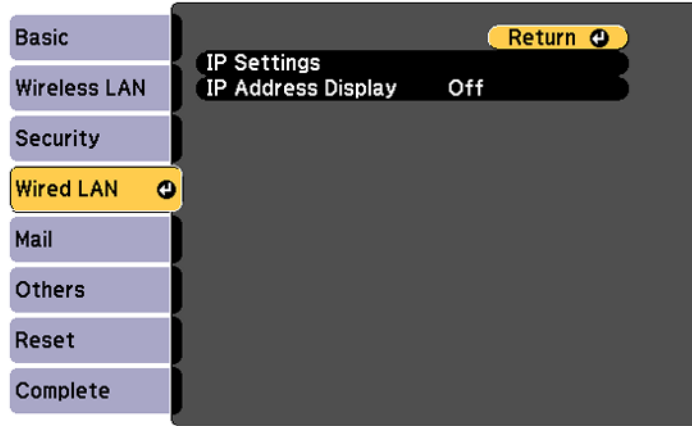

8. If necessary, select **IP Settings** and press **Enter**.
9. Select your IP Settings as necessary:
  - If your network assigns addresses automatically, turn on the **DHCP** setting.
  - If you must set addresses manually, turn off **DHCP** and enter the projector's **IP Address**, **Subnet Mask**, and **Gateway Address** as needed.

**Note:** To highlight the numbers you want from the displayed keyboard, press the arrow buttons on the remote control. To select a highlighted number, press **Enter**. Or, press and hold the **Num** button on the remote control while entering the desired numbers.

10. To prevent display of the IP address on the standby screen, turn off **IP Address Display**.
11. When you finish selecting settings, select **Complete** and follow the on-screen instructions to save your settings and exit the menus.

**Parent topic:** [Wired Network Projection](#)

## Wireless Network Projection

You can send images to your projector through a wireless network. To do this, you must install the optional Epson 802.11b/g/n wireless LAN module, and then set up your projector and computer for wireless projection.

**Note:** If your projector is connected via a LAN cable to a network that includes a wireless access point, you can connect to the projector wirelessly through the access point using the EasyMP Network Projection software without the need for the optional wireless module.

After installing the module and setting up the projector, install the network software from the *Epson Projector Software* CD or download the software, as necessary. Use the following software and documentation to set up, control, and monitor wireless projection:

- EasyMP Network Projection software sets up your computer for wireless network projection. See the *EasyMP Network Projection Operation Guide* for instructions.
- EasyMP Monitor software (Windows only) lets you monitor and control your projector through the network. You can download the latest software and documentation from the Epson web site. Go to [epson.com/support](http://epson.com/support) (U.S.) or [epson.ca/support](http://epson.ca/support) (Canada) and select your projector.
- EasyMP Multi PC Projection software allows you to hold interactive meetings by projecting the computer screens of users over a network. See the *EasyMP Multi PC Projection Operation Guide* for instructions.
- EasyMP Network Updater software (Windows only) allows you to update firmware for a projector over a wired LAN. See the *EasyMP Network Updater Operation Guide* for instructions. You can download the latest software and documentation from the Epson web site. Go to [epson.com/support](http://epson.com/support) (U.S.) or [epson.ca/support](http://epson.ca/support) (Canada) and select your projector.
- Projection from iOS or Android devices with the wireless LAN module and free Epson iProjection app; visit [epson.com/projectorapp](http://epson.com/projectorapp) (U.S.) or [epson.ca/projectorapp](http://epson.ca/projectorapp) (Canada) for more information

[Installing the Wireless LAN Module](#)

[Using Quick Wireless Connection \(Windows Only\)](#)

[Selecting Wireless Network Settings Manually](#)

[Selecting Wireless Network Settings in Windows](#)

[Selecting Wireless Network Settings in OS X](#)

[Setting Up Wireless Network Security](#)

**Parent topic:** [Using the Projector on a Network](#)

**Related references**

[Optional Equipment and Replacement Parts](#)

## Installing the Wireless LAN Module

To use the projector over a wireless network, install the Epson 802.11b/g/n wireless LAN module. Do not install any other type of wireless LAN module.

**Caution:** Never remove the LAN module while its indicator light is green or flashing, or while you are projecting wirelessly. You may damage the module or lose data.

**Note:** The wireless LAN module is not included with your projector and is optional.

1. Push up and hold the interface cover latch while pressing the button on the side as shown. Pull the interface cover straight off the projector.

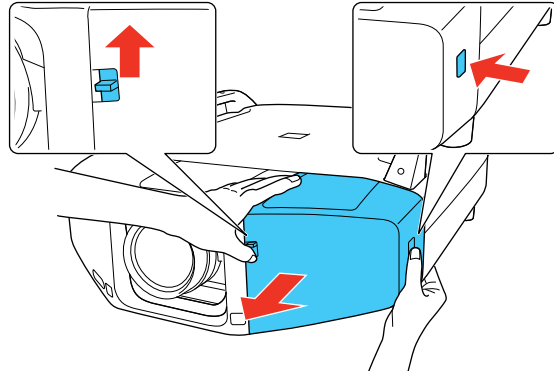

2. Insert the wireless LAN module into the port.

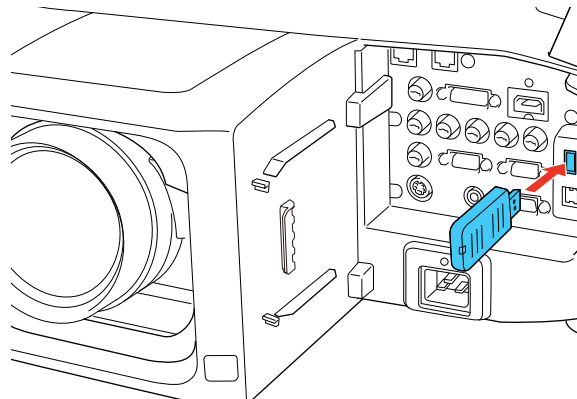

**Parent topic:** [Wireless Network Projection](#)

## Related references

[Optional Equipment and Replacement Parts](#)

## Using Quick Wireless Connection (Windows Only)

You can use the Quick Wireless Connection USB key to quickly connect your computer to the projector wirelessly. Then you can project your presentation and remove the key when you are done.

**Note:** The Quick Wireless Connection USB key is not included with your projector and is optional.

**Note:** Make sure the wireless LAN module is installed. The wireless LAN module is not included with your projector and is optional.

1. Turn on the projector.
2. Press the **LAN** button on the remote control.

You see a screen like this:

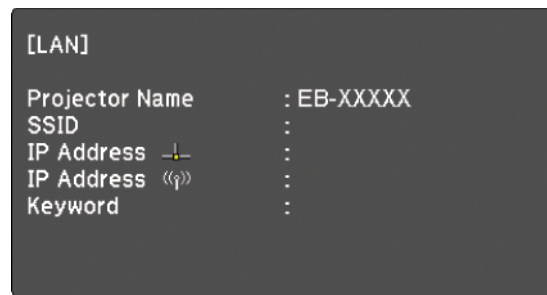

3. Verify that an SSID and IP address are displayed, then remove the wireless LAN module from the projector if necessary.

4. Insert the Quick Wireless Connection USB key into the same port used for the wireless LAN module.

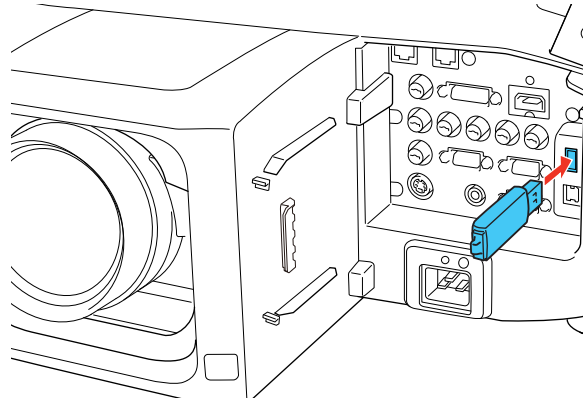

You see a projected message that the network information update is complete.

5. Remove the USB key.
6. Reinsert the wireless LAN module into the projector.
7. Connect the USB key to a USB port on your computer or laptop.

**Note:** In Windows Vista, if you see the AutoPlay window, select **Run LaunchQWRD.exe**, then select **Allow** on the next screen.

8. Follow the on-screen instructions to install the Quick Wireless Connection driver.

**Note:** If you see a Windows Firewall message, click **Yes** to disable the firewall for this application.

After a few minutes, your computer image is displayed by the projector. If it does not appear, press the **LAN** button on your remote control or restart your computer.

9. Run your presentation as necessary.
10. When you finish projecting wirelessly, select the **Safely Remove Hardware** option in the Windows taskbar, then remove the USB key from your computer.

**Note:** You may need to restart your computer to reactivate your wireless LAN connection.

**Parent topic:** [Wireless Network Projection](#)

## Selecting Wireless Network Settings Manually

Before you can project from your wireless network, you must select the network settings for the projector using its menu system.

1. Turn on the projector.
2. Press the **Menu** button.
3. Select the **Network** menu and press **Enter**.

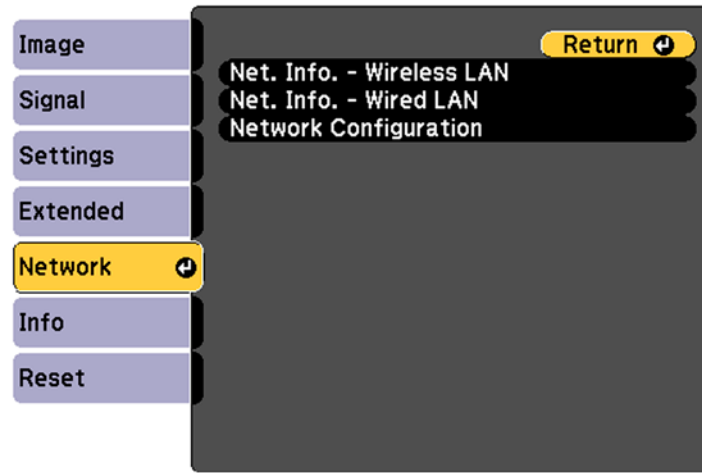

4. Select **Network Configuration** and press **Enter**.



5. Select the **Basic** menu and press **Enter**.

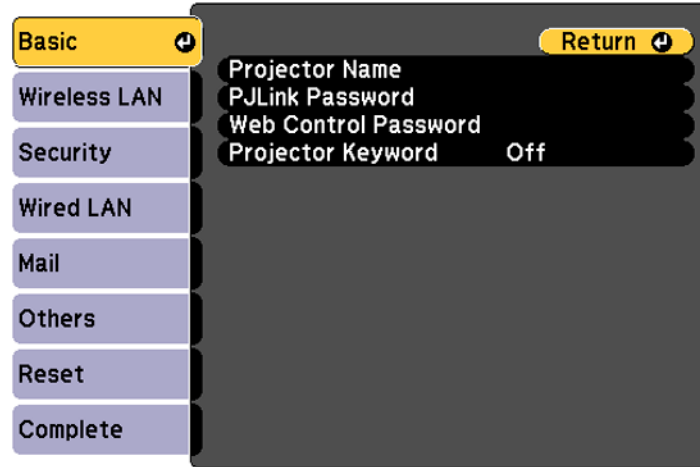

6. Select the following basic options as necessary:

- **Projector Name** lets you enter a name up to 16 alphanumeric characters long to identify the projector over the network.
- **PLink Password** lets you enter a password up to 32 alphanumeric characters long for using the PLink protocol for projector control.
- **Web Control Password** lets you enter a password up to 8 alphanumeric characters long for accessing the projector over the web. (Default user name is **EPSONWEB**; default password is **admin**.)
- **Projector Keyword** lets you turn on a security password to prevent access to the projector by anyone not in the room with it. You must enter a displayed, randomized keyword from a computer using the EasyMP Network Projection software to access the projector.

**Note:** Use the displayed keyboard to enter the name, passwords and keyword. Press the arrow buttons on the remote control to highlight characters and press **Enter** to select them.

7. Select the **Wireless LAN** menu and press **Enter**.

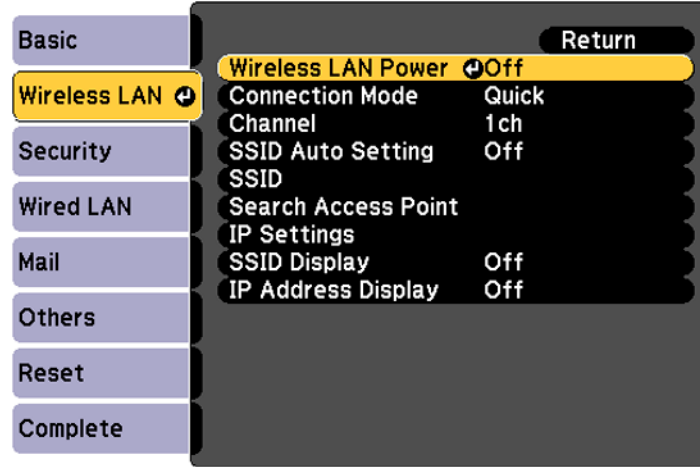

8. Select the settings on the **Wireless LAN** menu as necessary for your network.
9. When you finish selecting settings, select **Complete** and follow the on-screen instructions to save your settings and exit the menus.

After you complete the wireless settings for your projector, you need to select the wireless network on your computer.

[Wireless LAN Menu Settings](#)

Parent topic: [Wireless Network Projection](#)

### Wireless LAN Menu Settings

Setting	Options	Description
Wireless LAN Power	On Off	Turns on wireless LAN support

Setting	Options	Description
<b>Connection Mode</b>	<b>Quick</b> <b>Advanced</b>	Selects the type of wireless connection:  <b>Quick:</b> lets you quickly connect to one computer (Ad Hoc) or use the optional Quick Wireless Connection USB Key to connect  <b>Advanced:</b> lets you connect to multiple computers via a wireless network access point
<b>Channel</b>	<b>1ch</b> <b>6ch</b> <b>11ch</b>	In <b>Quick</b> connection mode, selects the frequency band (channel) used by the wireless LAN
<b>SSID Auto Setting</b>	<b>On</b> <b>Off</b>	Turns on automatic SSID searching in <b>Quick</b> connection mode; set to <b>Off</b> when connecting to multiple projectors at the same time
<b>SSID</b>	Up 32 alphanumeric characters	Sets the SSID (network name) of the wireless LAN system the projector is connecting to
<b>Search Access Point</b>	<b>To Search View</b>	Search for available wireless network access points in <b>Advanced</b> connection mode
<b>IP Settings</b>	<b>DHCP (On or Off)</b> <b>IP Address</b> <b>Subnet Mask</b> <b>Gateway Address</b>	Selects DHCP if your network assigns addresses automatically, or turns off DHCP so you can enter the network's IP address, subnet mask, and gateway address as needed
<b>SSID Display</b>	<b>On</b> <b>Off</b>	Selects whether to display the SSID on the network standby screen

Setting	Options	Description
IP Address Display	On Off	Selects whether to display the IP address on the network standby screen

Parent topic: [Selecting Wireless Network Settings Manually](#)

## Selecting Wireless Network Settings in Windows

Before connecting to the projector, select the correct wireless network on your computer.

1. To access your wireless utility software, access the Desktop and double-click the network icon on the Windows taskbar.
2. Do one of the following:
  - If your projector is set up on an existing network (Advanced mode), select the network name (SSID).
  - If your projector is configured for Quick mode, select the projector's SSID.
3. Click **Connect**.

Parent topic: [Wireless Network Projection](#)

## Selecting Wireless Network Settings in OS X

Before connecting to the projector, select the correct wireless network in OS X.

1. Click the AirPort icon on the menu bar at the top of the screen.
2. Make sure AirPort is turned on, then do one of the following:
  - If your projector is set up on an existing network (Advanced mode), select the network name (SSID).
  - If your projector is configured for Quick mode, select the projector's SSID.

Parent topic: [Wireless Network Projection](#)

## Setting Up Wireless Network Security

You can set up security for your projector to use on the wireless network. Set up one of the following security options to match the settings used on your network:

- WPA/WPA2-PSK security (Advanced connection mode)
- WPA2-PSK security (Advanced and Quick connection mode)

Check with your network administrator for guidance on entering the correct information.

1. Press the **Menu** button.
2. Select the **Network** menu and press **Enter**.
3. Select **Network Configuration** and press **Enter**.
4. Select the **Security** menu and press **Enter**.

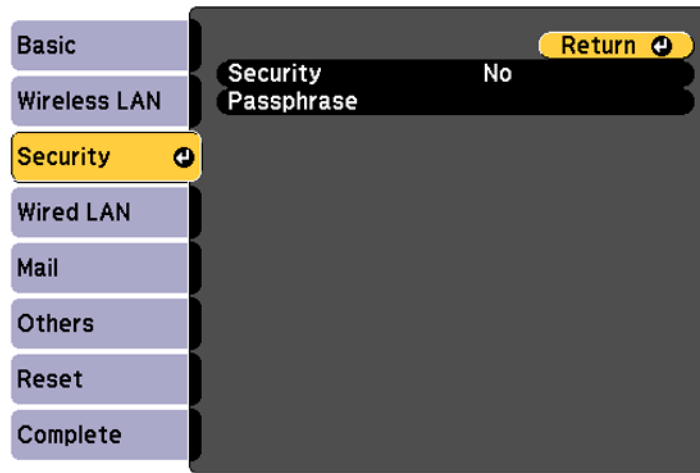

5. Select the security settings for your network.
6. When you finish selecting settings, select **Complete** and follow the on-screen instructions to save your settings and exit the menus.

#### [Wireless Security Menu Settings](#)

**Parent topic:** [Wireless Network Projection](#)

### Wireless Security Menu Settings

Settings on the Security menu let you select the type of security and security settings that match the network you are connecting the projector to.

Setting	Options	Description
<b>Security</b>	<b>WPA2-PSK</b> and <b>WPA</b> types available	Selects the type of security used on the wireless network

Setting	Options	Description
Passphrase	Various keys from 8 to 32 characters	Selects the pre-shared key used on the network; passphrases are case-sensitive

Parent topic: [Setting Up Wireless Network Security](#)

## Setting Up Projector Network E-Mail Alerts

You can set up the projector to send you an e-mail alert over the network if there is a problem with the projector.

1. Press the **Menu** button.
2. Select the **Network** menu and press **Enter**.
3. Select **Network Configuration** and press **Enter**.
4. Select the **Mail** menu and press **Enter**.

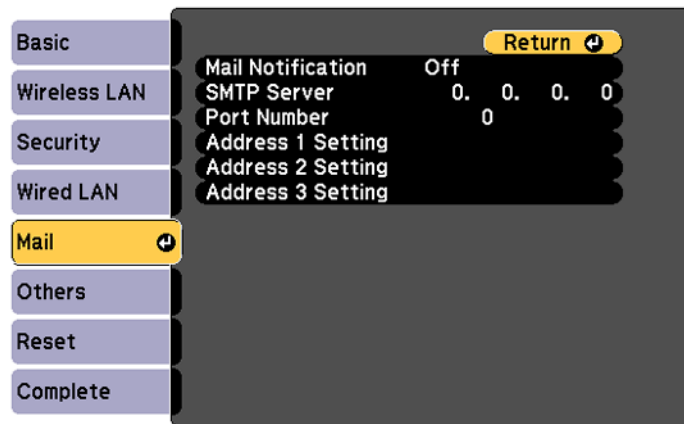

5. Turn on **Mail Notification**.
6. Enter the IP address for the **SMTP Server** option.

**Note:** To enter the IP address using the numeric keys on the remote control, press and hold the **Num** button. Do not use these addresses: 127.x.x.x or 224.0.0.0 through 255.255.255.255 (where x is a number from 0 to 255).

7. Select a number for the SMTP server **Port Number**, from 1 to 65535 (default is 25).
8. Choose an **Address** field, enter the e-mail address, and select the alerts you want to receive there. Repeat for up to three addresses.

**Note:** Your e-mail address can be up to 32 alphanumeric characters long.

9. When you finish selecting settings, select **Complete** and follow the on-screen instructions to save your settings and exit the menus.

**Note:** If a critical problem causes a projector to shut down, you may not receive an e-mail alert.

[Network Projector E-mail Alert Messages](#)

**Parent topic:** [Using the Projector on a Network](#)

## Network Projector E-mail Alert Messages

When a problem occurs with a networked projector, and you selected to receive e-mail alerts, you receive an e-mail containing the following information:

- **Epson Projector** on the subject line
- The name of the projector experiencing a problem
- The IP address of the affected projector
- Detailed information about the problem

**Note:** If a critical problem causes a projector to shut down, you may not receive an e-mail alert.

**Parent topic:** [Setting Up Projector Network E-Mail Alerts](#)

## Setting Up Monitoring Using SNMP

Network administrators can install SNMP (Simple Network Management Protocol) software on network computers so they can monitor projectors. If your network uses this software, you can set up the projector for SNMP monitoring.

1. Press the **Menu** button.
2. Select the **Network** menu and press **Enter**.
3. Select **Network Configuration** and press **Enter**.

4. Select the **Others** menu and press **Enter**.

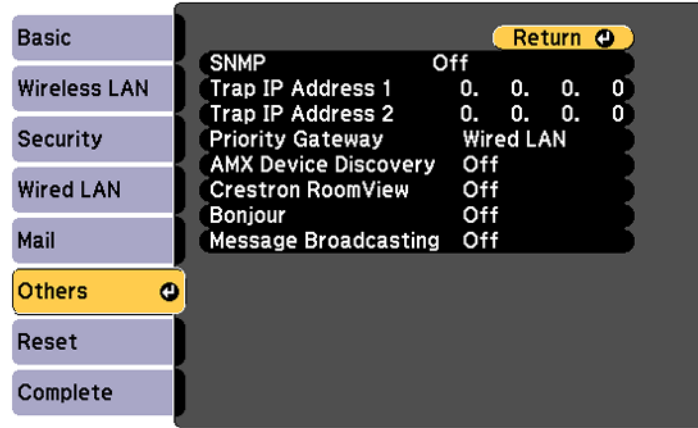

5. Enter up to two IP addresses to receive SNMP notifications, using 0 to 255 for each address field.

**Note:** Do not use these addresses: 127.x.x.x or 224.0.0.0 through 255.255.255.255 (where x is a number from 0 to 255).

6. If available, select the **Priority Gateway** setting for your network.
7. If your network environment uses an AMX controller, turn on the **AMX Device Discovery** setting to allow the projector to be detected.
8. If your network environment uses a Crestron RoomView controller, turn on the **Crestron RoomView** setting to allow the projector to be detected.
9. If you are connecting to a network using Bonjour, turn on the **Bonjour** setting.
10. If you want this projector to receive broadcasted messages over the network, turn on the **Message Broadcasting** setting. Administrators can broadcast messages over the network using the Message Broadcasting plug-in for EasyMP Monitor (Windows only).
11. When you finish selecting settings, select **Complete** and follow the on-screen instructions to save your settings and exit the menus.

**Parent topic:** [Using the Projector on a Network](#)



## Controlling a Networked Projector Using a Web Browser

Once you have connected your projector to your network, you can select projector settings and control projection using a compatible web browser. This lets you access the projector remotely.

**Note:** The web setup and control features support Microsoft Internet Explorer 8.0 or later, and Safari on networks that do not use a proxy server for connection. You cannot select all of the projector menu settings or control all projector functions using a web browser.

**Note:** If you set Standby Mode to **Communication On**, you can use a web browser to select settings and control projection even if the projector is in standby mode.

1. Make sure the projector is turned on.
2. Start your web browser on a computer or device connected to the network.
3. Type the projector's IP address into the browser's address box and press the computer's **Enter** key.

**Note:** You may need to log in before you see the Web Control screen. If you see a log in window, enter your user name and password. (The default user name is **EPSONWEB** and the default password is **admin**.)

You see the Web Control screen.

4. To select projector menu settings, select the name of the menu and follow the on-screen instructions.
5. To control projection remotely, select the **Web Remote** option.

You see a screen like this:

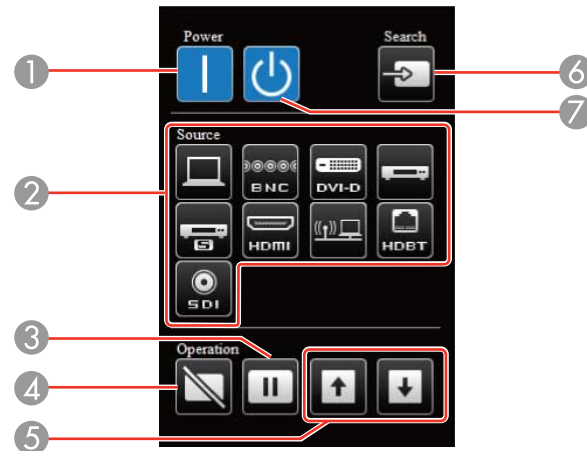

- 1 Power on button control
- 2 Input source selection controls (some buttons may not be available depending on the model)
- 3 **Freeze** button control
- 4 **Shutter** button control
- 5 **Page Up** and **Page Down** button controls
- 6 Source search control
- 7 Power off button control

6. Select the icon corresponding to the projector function you want to control.

[Operating a Lens from a Web Browser](#)

**Parent topic:** [Using the Projector on a Network](#)

**Related references**

[Projector Setup Settings - Extended Menu](#)

## Operating a Lens from a Web Browser

You can operate a lens from the web browser.

1. Make sure the projector is turned on.
2. Start your web browser on a computer connected to the network.
3. Type the projector's IP address into the browser's address box and press the computer's **Enter** key.  
You see the Web Control screen.

**Note:** You may need to log in before you see the Web Control screen. If you see a log in window, enter your user name and password. (The default user name is **EPSONWEB** and the default password is **admin**.)

4. Select the **Lens Control** option.



You see a screen like this:

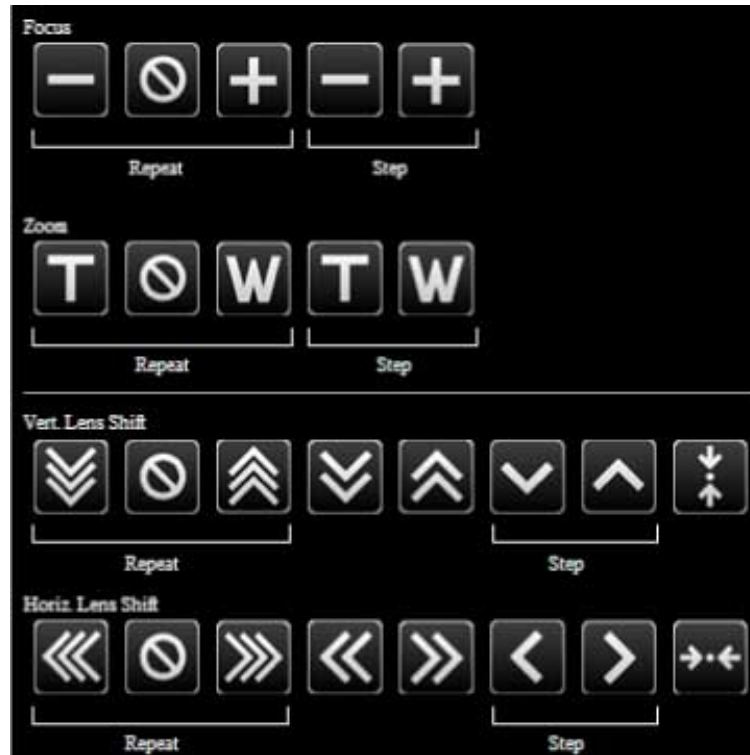

5. Use the buttons on the screen to adjust the **Focus**, **Zoom**, **Vertical Lens Shift**, and **Horizontal Lens Shift** features.

Parent topic: [Controlling a Networked Projector Using a Web Browser](#)

## Crestron RoomView Support

If you are using the Crestron RoomView network monitoring and control system, you can set up your projector for use on the system. Crestron RoomView lets you control and monitor your projector using a web browser.

**Note:** You cannot use the Epson Web Control feature or the Message Broadcasting plug-in for EasyMP Monitor when you use Crestron RoomView.

For additional information on Crestron RoomView, contact Crestron.

[Setting Up Crestron RoomView Support](#)

[Controlling a Networked Projector Using Crestron RoomView](#)

**Parent topic:** [Using the Projector on a Network](#)

## Setting Up Crestron RoomView Support

To set up your projector for monitoring and control using a Crestron RoomView system, make sure your computer and projector are connected to the network. If you are connecting wirelessly, set up the projector using the Advanced network connection mode.

**Note:** If you want to use the Crestron RoomView system when the projector is turned off, you need to adjust the **Standby Mode** settings in the Extended menu.

1. Press the **Menu** button.
2. Select the **Network** menu and press **Enter**.
3. Select **Network Configuration** and press **Enter**.
4. Select the **Others** menu and press **Enter**.

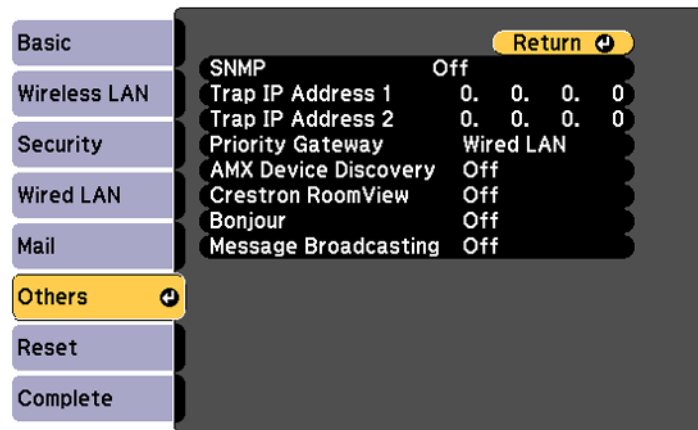

5. Set the **Crestron RoomView** setting to **On** to allow the projector to be detected.

**Note:** Enabling Crestron RoomView disables the Epson Message Broadcasting feature in the EasyMP Monitor software.

6. When you finish selecting settings, select **Complete** and follow the on-screen instructions to save your settings and exit the menus.
7. Turn off the projector, then turn it on again to enable the setting.

**Parent topic:** [Crestron RoomView Support](#)

**Related references**

[Projector Setup Settings - Extended Menu](#)

## Controlling a Networked Projector Using Crestron RoomView

Once you have set up your projector to use Crestron RoomView, you can control and monitor projection using a compatible web browser.

1. Start your web browser on a computer connected to the network.
2. Type the projector's IP address into the browser's address box and press the computer's **Enter** key.

You see this screen:

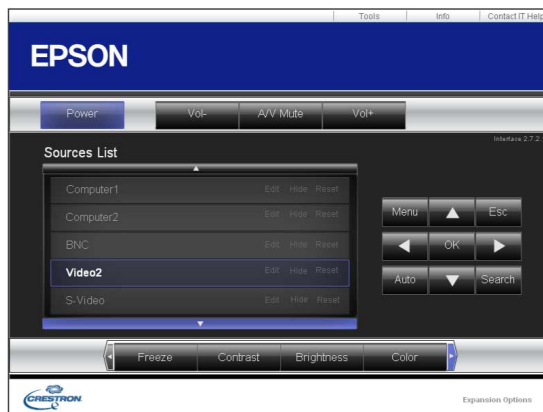

3. Select the input source that you want to control in the Sources List box. You can scroll through available sources using the up and down arrows in the box.

4. To control projection remotely, click the on-screen buttons that correspond to the projector's remote control buttons. You can scroll through button options at the bottom of the screen.

**Note:** These on-screen buttons do not directly correspond to the projector's remote control buttons:

- **OK** acts as the **Enter** button
- **Menu** displays the projector's menu

5. To view information about the projector, click the **Info** tab.
6. To change projector, Crestron, and password settings, click the **Tools** tab, select settings on the displayed screen, and click **Send**.
7. When you finish selecting settings, click **Exit** to exit the program.

**Parent topic:** [Crestron RoomView Support](#)

---

# Using Basic Projector Features

Follow the instructions in these sections to use your projector's basic features.

[Turning On the Projector](#)

[Turning Off the Projector](#)

[Selecting the Language for the Projector Menus](#)

[Setting the Screen Type](#)

[Adjusting the Image Position Using Lens Shift](#)

[Adjusting the Image Position Using Screen Position](#)

[Displaying a Test Pattern](#)

[Adjusting the Image Height](#)

[Image Shape](#)

[Resizing the Image with the Zoom Button](#)

[Focusing the Image Using the Focus Button](#)

[Remote Control Operation](#)

[Selecting an Image Source](#)

[Selecting the Lamp](#)

[Projection Modes](#)

[Image Aspect Ratio](#)

[Color Mode](#)

[Setting the Date and Time](#)

## Turning On the Projector

Turn on the computer or video equipment you want to use before you turn on the projector so it can display the image source.



1. Connect the power cord to the projector's power inlet.

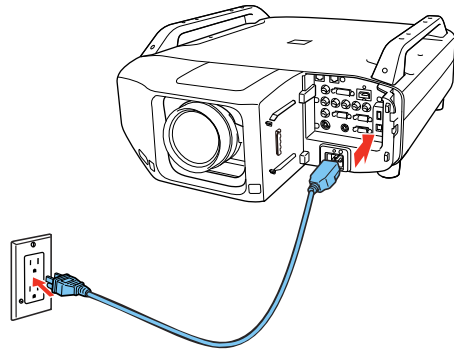

2. Plug the power cord into an electrical outlet.

**Note:** With **Direct Power On** turned on, the projector turns on as soon as you plug it in.

The projector's power light turns blue. This indicates that the projector is receiving power.

3. Press the **On** button on the projector or remote control to turn on the projector.

The Status light flashes blue as the projector warms up. Once the projector is warmed up, the Status light stops flashing and turns blue.

**Warning:** Never look into the projector lens when the lamp is on. This can damage your eyes and is especially dangerous for children.

If you do not see a projected image right away, try the following:

- Turn on the connected computer or video device.
- Insert a DVD or other video media and press the play button, if necessary.
- Press the **Search** button on the remote control to detect the video source.
- Press the button for the video source on the remote control.

**Parent topic:** [Using Basic Projector Features](#)

**Related references**

[Projector Setup Settings - Extended Menu](#)

## Turning Off the Projector

Before turning off the projector, shut down any computer connected to it so you can see the computer display during shutdown.

**Note:** Turn off this product when not in use to prolong the life of the projector. Lamp life will vary depending upon mode selected, environmental conditions, and usage. Brightness decreases over time.

1. Press the **Standby** button on the projector or remote control.
2. If you see a shutdown confirmation screen, press the **Standby** button on the projector or remote control again. (To leave the projector on, press any other button.)

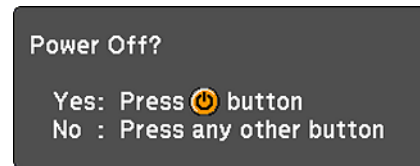

The projector beeps twice, the lamps turn off, and the Status light turns off.

**Note:** With Epson's Instant Off technology, there is no cool-down period so you can pack up the projector for transport right away (if necessary).

3. To transport or store the projector, make sure the Status light is off, then unplug the power cord.

**Caution:** To avoid damaging the projector or lamp, never unplug the power cord when the Status light is on or flashing blue.

**Parent topic:** [Using Basic Projector Features](#)

## Selecting the Language for the Projector Menus

If you want to view the projector's menus and messages in another language, you can change the Language setting.

1. Turn on the projector.
2. Press the **Menu** button.

3. Select the **Extended** menu and press **Enter**.

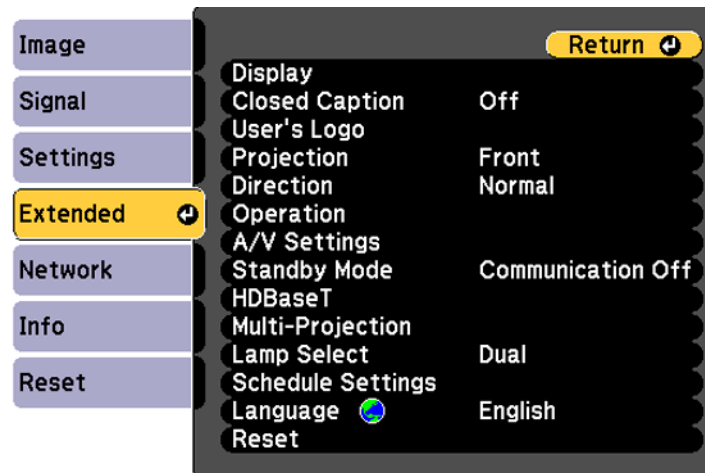

4. Select the **Language** setting and press **Enter**.
5. Select the language you want to use and press **Enter**.
6. Press **Menu** or **Esc** to exit the menus.

Parent topic: [Using Basic Projector Features](#)

## Setting the Screen Type

You can use the Screen Type setting to match the aspect ratio of the displayed image to the screen you are using.

1. Turn on the projector and display an image.
2. Press the **Menu** button.
3. Select the **Extended** menu and press **Enter**.
4. Select **Display > Screen > Screen Type**.

You see this screen:

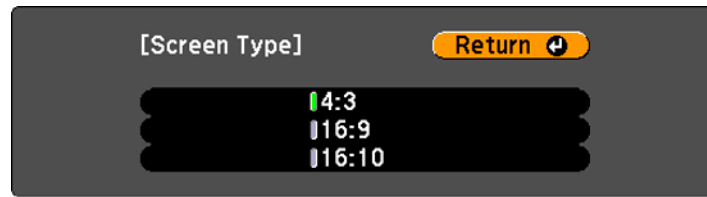

5. Select your screen's aspect ratio and press **Enter**.
6. Press the **Menu** button to accept the changes.
7. Adjust the aspect ratio for the projected image, if necessary.

**Parent topic:** [Using Basic Projector Features](#)

**Related concepts**

[Image Aspect Ratio](#)

## Adjusting the Image Position Using Lens Shift

If you cannot install the projector directly in front of the screen, you can adjust the position of the projected image using the lens shift feature.

**Note:** Wait 30 minutes after turning on the projector before setting the focus, zoom, and lens shift for maximum accuracy.

1. Turn on the projector and display an image.

2. Press the **Lens Shift** button on the control panel or remote control.

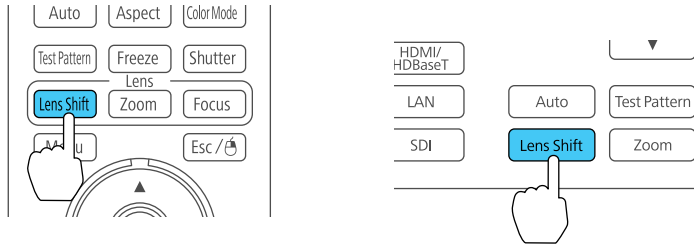

3. Press the arrow buttons to adjust the position of the projected image as necessary.

### PowerLite Pro Z9870NL/Z11005NL

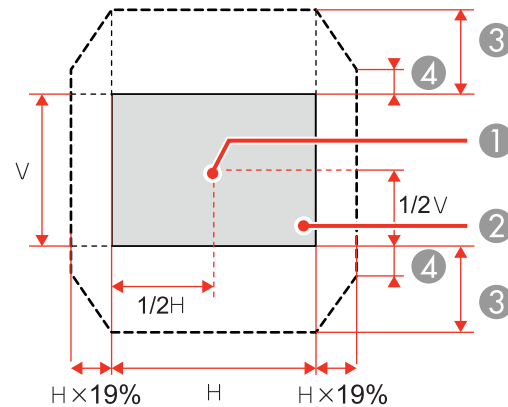

- 1 Center of lens
- 2 Projected image when lens shift is set in the center
- 3 Maximum vertical range ( $V \times 56\%$ )
- 4 Maximum horizontal range ( $H \times 19\%$ )

**Note:** You cannot move the image to both the horizontal and vertical maximum values.

**PowerLite Pro**  
**Z9800WNL/Z9900WNL/Z11000WNL/Z9750UNL/Z9870UNL/Z10000UNL/Z10005UNL**

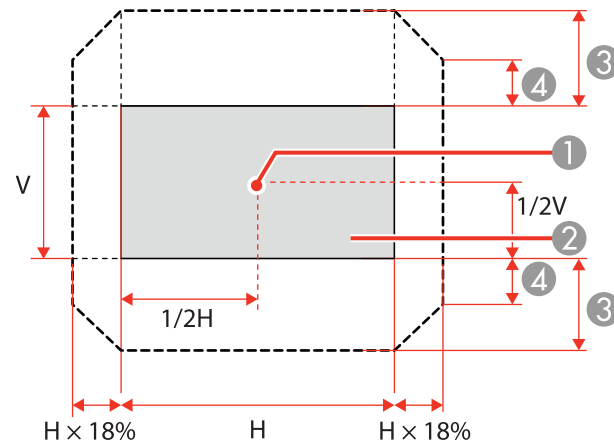

- 1 Center of lens
- 2 Projected image when lens shift is set in the center
- 3 Maximum vertical range ( $V \times 60\%$ )
- 4 Maximum horizontal range ( $H \times 18\%$ )

**Note:** You cannot move the image to both the horizontal and vertical maximum values.

4. When you are finished, press the **Esc** button on the control panel or remote control.

**Note:** When adjusting the image height, position the image lower than where you want it to be and then move it up. This will help prevent the image from moving down after adjustment.

**Parent topic:** [Using Basic Projector Features](#)

## Adjusting the Image Position Using Screen Position

You can adjust the image position if there are margins between the edge of the image and the projected screen frame.

**Note:** You cannot adjust the screen position if the Screen Type is set to **16:10** for the PowerLite Pro Z9800WNL, Z9900WNL, Z11000WNL, Z9750UNL, Z9870UNL, Z10000UNL, or Z10005UNL models, or **4:3** for the PowerLite Pro Z9870NL and Z11005NL models.

1. Turn on the projector and display an image.
2. Press the **Menu** button.
3. Select the **Extended** menu and press **Enter**.
4. Select **Display > Screen > Screen Position**.
5. Use the arrow buttons on the remote control or projector to adjust the position of the image.

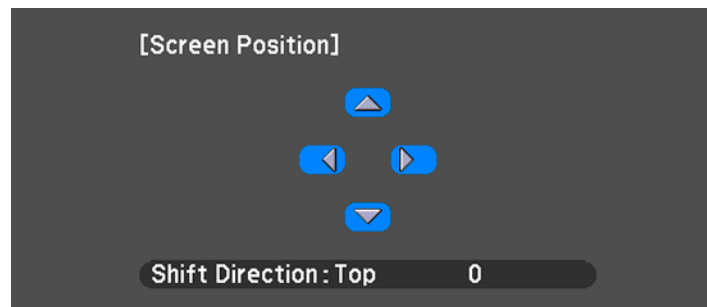

6. When you are finished, press the **Menu** button.

**Parent topic:** [Using Basic Projector Features](#)

## Displaying a Test Pattern

You can display a test pattern to adjust the projected image without connecting a computer or video device.

**Note:** The test pattern's shape is determined by the Screen Type setting. Be sure to set the correct screen type before adjusting with the test pattern.

1. Turn on the projector.
2. Press the **Test Pattern** button on the remote control or control panel.

3. Press the left or right arrow buttons on the remote control or press **Enter** on the control panel to cycle through the available test patterns.

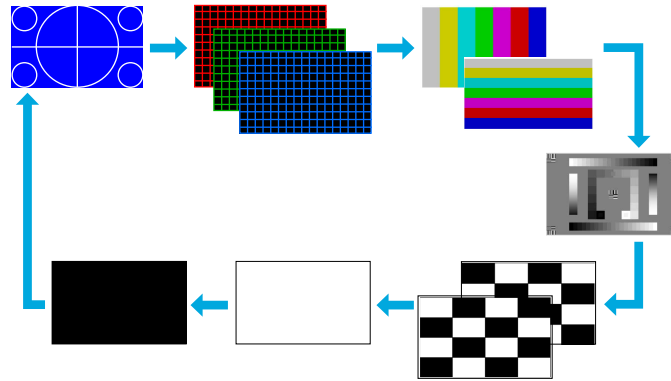

4. Adjust the image as necessary.
5. Press the **Esc** to exit the test pattern.

[Available Test Pattern Image Adjustments](#)

**Parent topic:** [Using Basic Projector Features](#)

**Related tasks**

[Setting the Screen Type](#)

## Available Test Pattern Image Adjustments

You can make the following image adjustments while the test pattern is displayed.



Menu	Settings
Image	Color Mode
	Color Temp.
	Advanced <ul style="list-style-type: none"> <li>• Gamma<sup>1</sup></li> <li>• RGB</li> <li>• RGBCMY</li> </ul>
	Reset
Signal	Auto Setup
Settings	Geometric Correction
Extended	Multi-Projection <sup>2</sup>

<sup>1</sup> Except for custom **Gamma** settings

<sup>2</sup> Except for the **Black Level** setting

Parent topic: [Displaying a Test Pattern](#)

## Adjusting the Image Height

If you are projecting from a table or other flat surface, and the image is too high or low, you can adjust the image height using the projector's adjustable feet.

1. Turn on the projector and display an image.
2. To adjust the image height, or the projector's horizontal and vertical tilt, rotate the front or rear feet to extend or retract them.

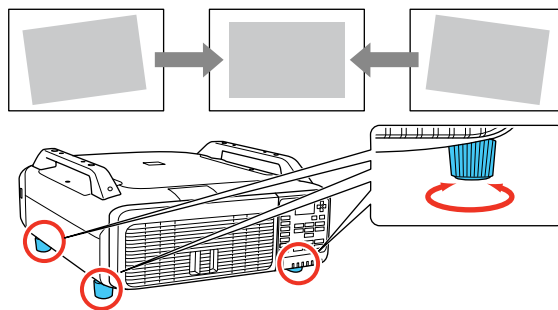

If the projected image is unevenly rectangular, you need to adjust the image shape.

**Parent topic:** [Using Basic Projector Features](#)

**Related concepts**

[Image Shape](#)

**Related references**

[Projector Feature Settings - Settings Menu](#)

## Image Shape

You can project an evenly rectangular image by placing the projector directly in front of the center of the screen and keeping it level. If you place the projector at an angle to the screen, or tilted up or down, or off to the side, you may need to correct the image shape for the best display quality.

[Correcting Image Shape with H/V Keystone](#)

[Correcting Image Shape with Quick Corner](#)

[Correcting Image Shape with Curved Surface](#)

[Correcting Image Shape with Point Correction](#)

[Correcting Image Shape with Corner Wall](#)

**Parent topic:** [Using Basic Projector Features](#)

## Correcting Image Shape with H/V Keystone

You can use the projector's H/V Keystone setting to correct the shape of an image that is unevenly rectangular on the sides.

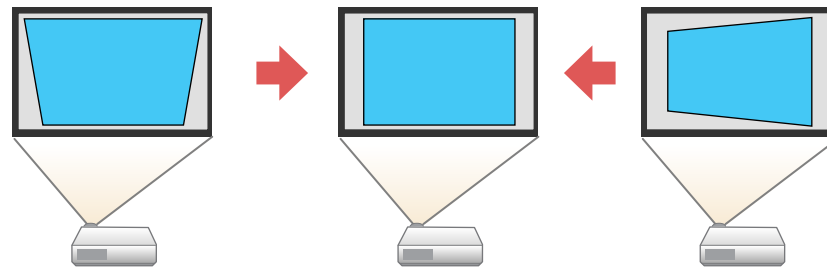

1. Turn on the projector and display an image.

**Note:** You can display a pattern to aid in adjusting the projected image using the Settings menu.

2. Press the **Menu** button.
3. Select the **Settings** menu and press **Enter**.

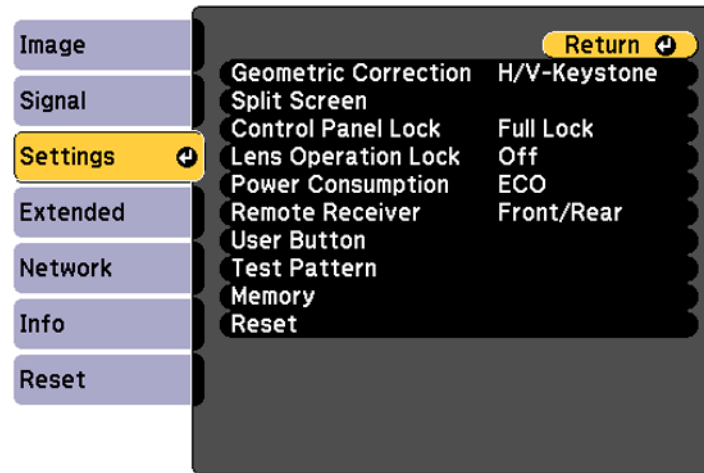

4. Select the **Geometric Correction** setting and press **Enter**.
5. Select the **H/V-Keystone** setting and press **Enter**. Then press **Enter** again.

You see the H/V-Keystone adjustment screen:



6. Use the arrow buttons on the projector or the remote control to select between vertical and horizontal keystone correction and to adjust the image shape as necessary.

### V-Keystone

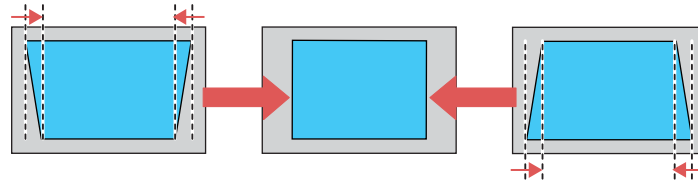

### H-Keystone

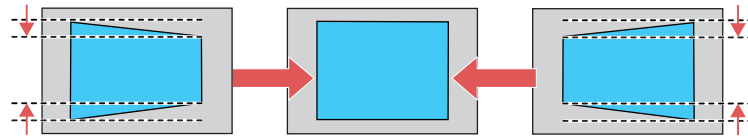

7. When you are finished, press **Esc**.  
After correction, your image is slightly smaller.

**Parent topic:** [Image Shape](#)

### Related references

[Projector Feature Settings - Settings Menu](#)

### Related tasks

[Displaying a Test Pattern](#)

## Correcting Image Shape with Quick Corner

You can use the projector's Quick Corner setting to correct the shape and size of an image that is unevenly rectangular on all sides.

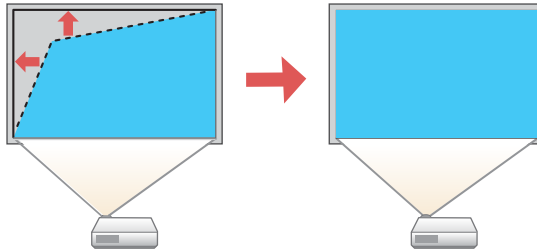

1. Turn on the projector and display an image.

**Note:** You can display a pattern to aid in adjusting the projected image using the Settings menu.

2. Press the **Menu** button.
3. Select the **Settings** menu and press **Enter**.

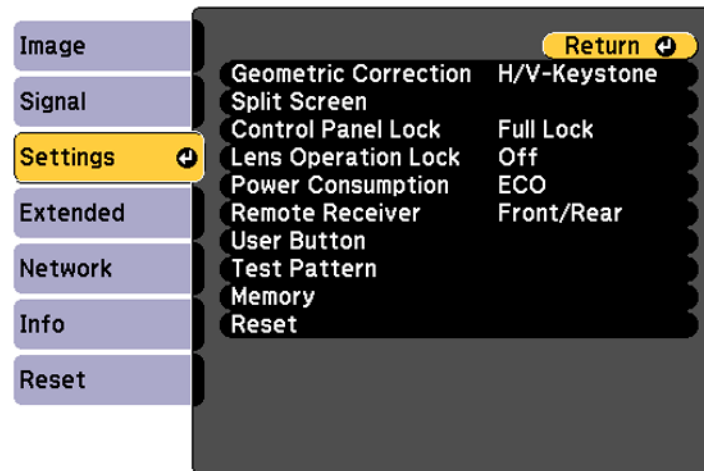

4. Select the **Geometric Correction** setting and press **Enter**.

5. Select the **Quick Corner** setting and press **Enter**. Then press **Enter** again.  
You see the Quick Corner adjustment screen:

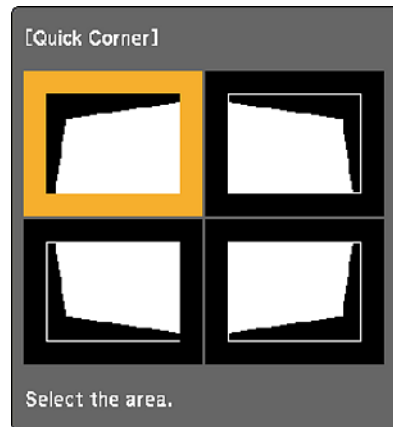

6. Use the arrow buttons on the projector or the remote control to select the corner of the image you want to adjust. Then press **Enter**.
7. Press the arrow buttons to adjust the image shape as necessary.
8. When you are finished, press **Esc**.

**Parent topic:** [Image Shape](#)

**Related references**

[Projector Feature Settings - Settings Menu](#)

**Related tasks**

[Displaying a Test Pattern](#)

## Correcting Image Shape with Curved Surface

You can use the projector's Curved Surface setting to adjust the shape of an image projected on a curved surface.

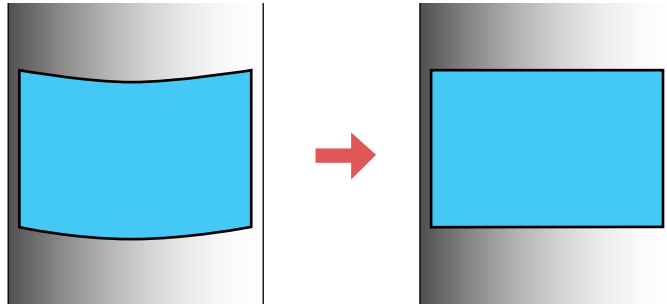

**Note:** For the best results, keep the lens centered using lens shift. The image may not be evenly focused throughout even after performing the steps here.

1. Turn on the projector and display an image.

**Note:** You can display a pattern to aid in adjusting the projected image using the Settings menu.

2. Press the **Menu** button.

3. Select the **Settings** menu and press **Enter**.

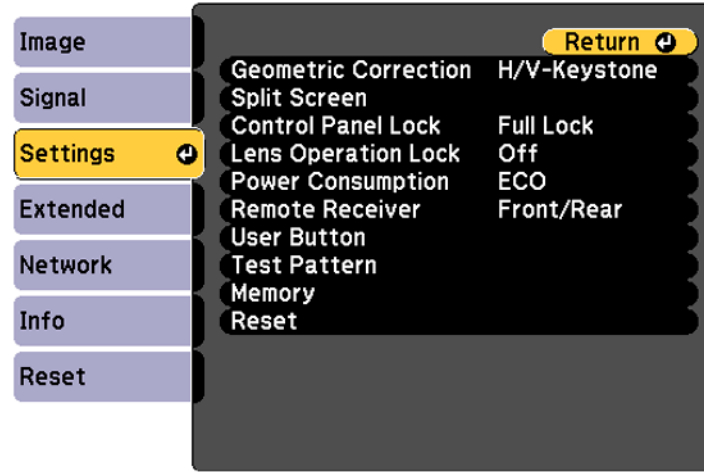

4. Select the **Geometric Correction** setting and press **Enter**.
5. Select the **Curved Surface** setting and press **Enter**.

**Note:** If you see a confirmation message, press **Enter**.

You see this screen:

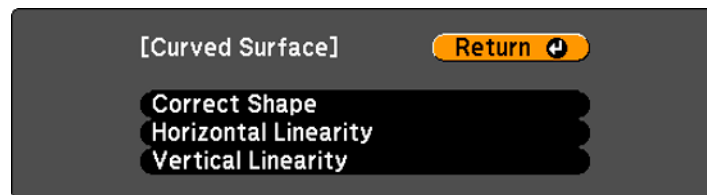

6. Select the **Correct Shape** setting and press **Enter**.



7. Use the arrow buttons on the projector or the remote control to select the area you want to adjust. Then press **Enter**.

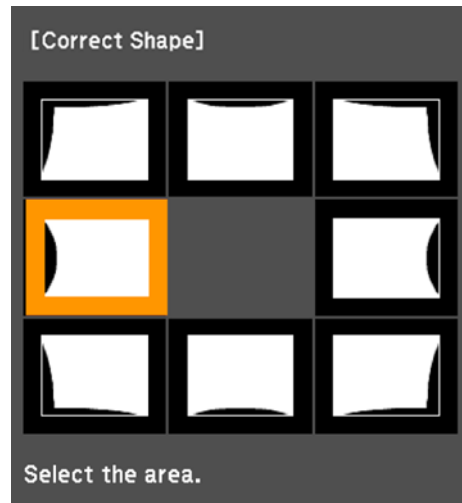

**Note:** To reset your adjustments, press the **Esc** button for at least 2 seconds to display a reset screen, and select **Yes**.

8. Use the arrow buttons on the projector to adjust the image shape.

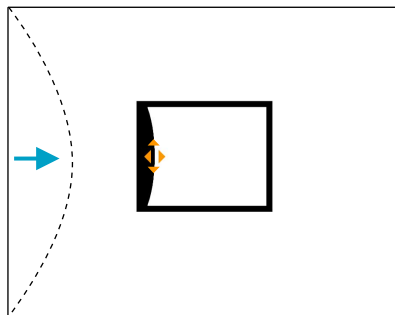

**Note:** If the adjustment triangle turns gray, you cannot adjust the shape any further in that direction.

9. Press the **Esc** button to return to the Curved Surface menu screen.
10. Repeat the previous three steps as necessary to adjust other image areas.  
If the image expands or contracts, continue with the next step to adjust the linearity.
11. Select one of the following from the Curved Surface menu screen:
  - **Horizontal Linearity:** Adjusts horizontal expansion or contraction.
  - **Vertical Linearity:** Adjusts vertical expansion or contraction.
12. Select a displayed line to use as a baseline and press **Enter**.  
The selected baseline flashes red and white.
13. Adjust the linearity by doing one of the following:
  - Press the left arrow button to contract the distance between the lines closest to the baseline.

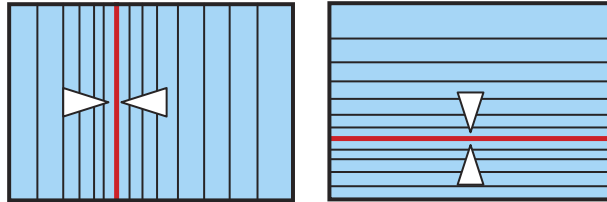

- Press the right arrow button to expand the distance between the lines closest to the baseline.

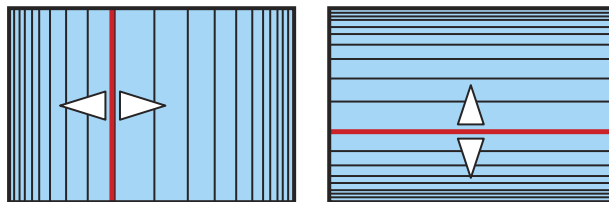

14. When you are finished, press **Menu**.

**Note:** If necessary, you can fine-tune the results of your Curved Surface adjustments using Point Correction.

**Parent topic:** [Image Shape](#)

## Related references

[Projector Feature Settings - Settings Menu](#)

## Related tasks

[Displaying a Test Pattern](#)

[Correcting Image Shape with Point Correction](#)

# Correcting Image Shape with Point Correction

You can use the projector's Point Correction feature to fine-tune the image shape using points on a grid.

1. Turn on the projector and display an image.

**Note:** You can display a pattern to aid in adjusting the projected image using the Settings menu.

2. Press the **Menu** button.
3. Select the **Settings** menu and press **Enter**.
4. Select the **Geometric Correction** setting and press **Enter**.
5. Select the **Point Correction** setting and press **Enter**.

**Note:** If you see a confirmation message, press **Enter**.

You see this screen:

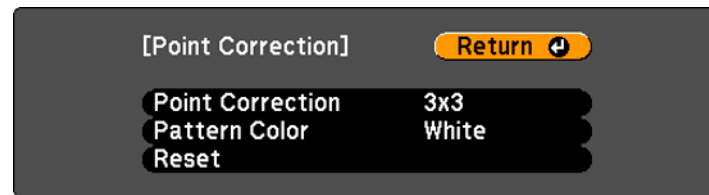

6. Select the **Point Correction** setting and press **Enter**.
7. Select the number of grid lines to display and press **Enter**.

**Note:** If you need to change the color of the grid lines, select the **Pattern Color** setting and select a suitable color.

- Use the arrow buttons on the projector or remote control to move to the point on the grid that you want to adjust. Then press **Enter**.

The box changes from a single line to a double-lined square.

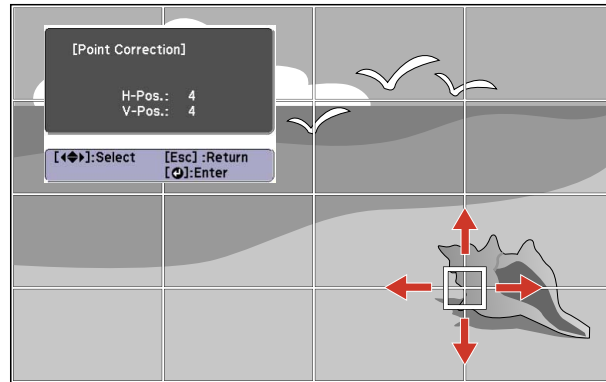

- Use the arrow buttons to correct the image shape in all necessary directions.

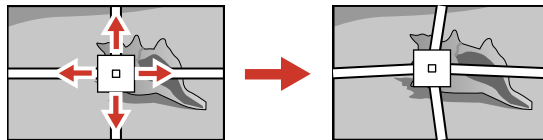

**Note:** You can press **Enter** to show or hide the image and grid to check the results.

- Press **Esc** to return to the previous screen and select another point to correct, if necessary.
- When you are finished, press **Menu**.

**Parent topic:** [Image Shape](#)

#### **Related references**

[Projector Feature Settings - Settings Menu](#)

#### **Related tasks**

[Displaying a Test Pattern](#)

## Correcting Image Shape with Corner Wall

You can use the projector's Corner Wall setting to adjust the shape of an image projected on a surface with right angles, such as a rectangular pillar or the corner of a room.

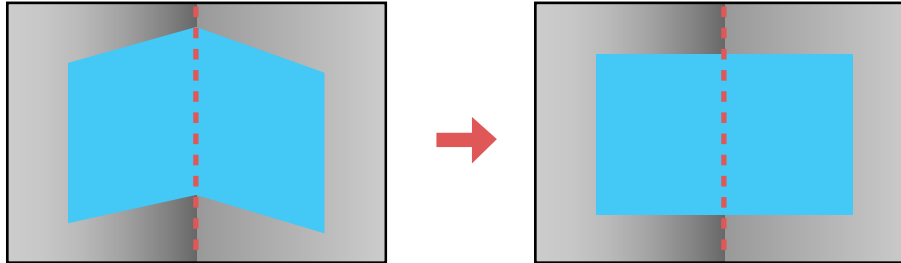

**Note:** After performing these steps, the image may not be evenly focused throughout.

1. Turn on the projector and display an image.

**Note:** You can display a pattern to aid in adjusting the projected image using the Settings menu.

2. Press the **Menu** button.
3. Select the **Settings** menu and press **Enter**.

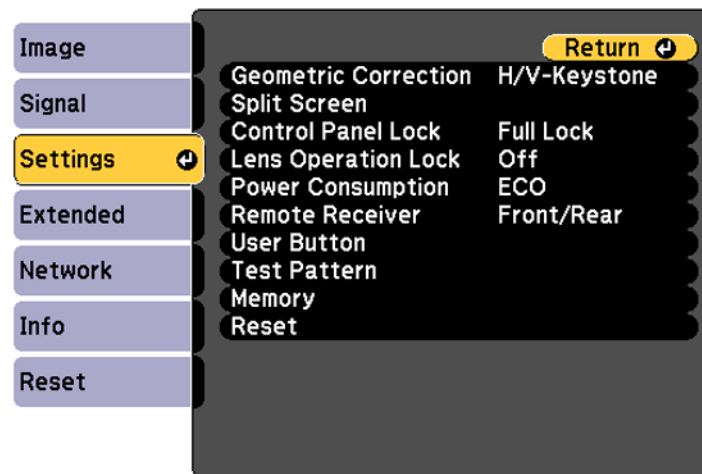

4. Select the **Geometric Correction** setting and press **Enter**.
5. Select the **Corner Wall** setting and press **Enter**.

**Note:** If you see a confirmation message, press **Enter**.

You see this screen:

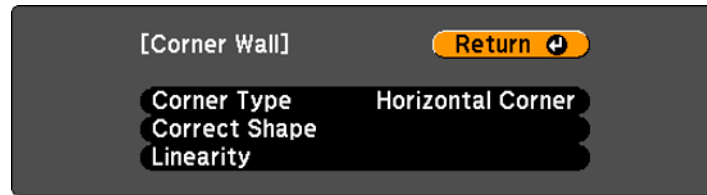

6. Select the **Corner Type** setting and press **Enter**.
7. Select one of the following:
  - **Horizontal Corner** when the surfaces line up horizontally

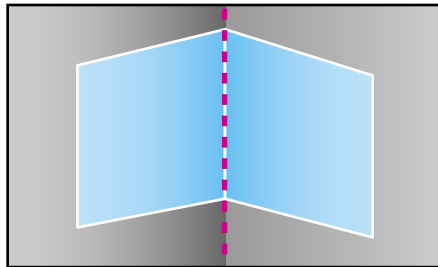

- **Vertical Corner** when the surfaces line up vertically

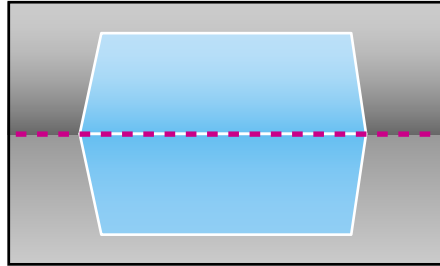

8. Press the **Esc** button to return to the Corner Wall menu screen.
9. Select the **Correct Shape** setting and press **Enter**.
10. Adjust the projector's position and use the lens shift option to center the image over the point where the two surfaces meet. (The rest of these steps show Horizontal Corner as the selected Corner Type but the steps are the same for Vertical Corner.)

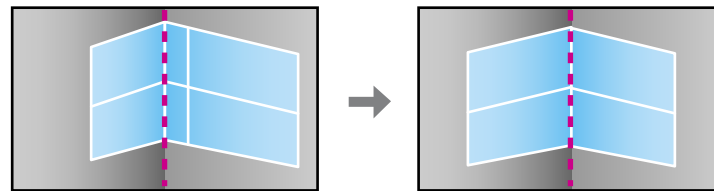

**Note:** You can press **Enter** to show or hide the image and grid to check the results.

11. Use the arrow buttons on the projector or the remote control to select the area you want to adjust. Then press **Enter**.

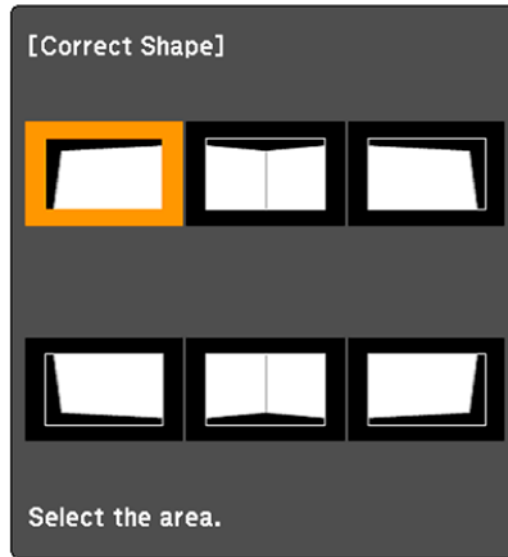

- For horizontal corners, adjust the top area using the lowest point (indicated by the blue arrow) as your reference. Adjust the lower area using the highest point (indicated by the pink arrow) as your reference.

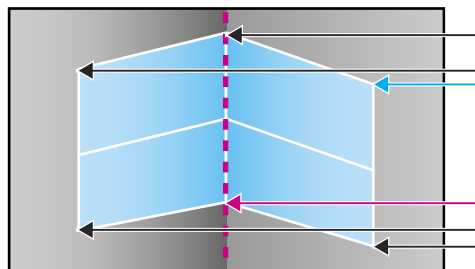

- For vertical corners, adjust the left and right areas using the points nearest the center of the image as your reference points.



**Note:** To reset your adjustments, press the **Esc** button for at least 2 seconds to display a reset screen, and select **Yes**.

12. Press and hold the arrow buttons on the projector or remote control to adjust the image shape.
13. Repeat the previous two steps as necessary to adjust other image areas.

If the image expands or contracts, continue with the next step to adjust the linearity.

14. Press the **Esc** button to return to the Corner Wall screen.
15. Select the **Linearity** setting and press **Enter**.

16. Adjust the linearity by doing the following as necessary:

- Press and hold the left arrow button to contract the distance between the lines closest to the left or top of the image.

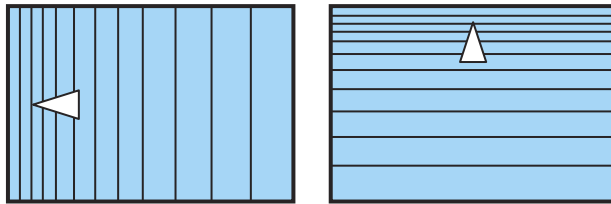

- Press and hold the right arrow button to contract the distance between the lines closest to the right or bottom of the image.

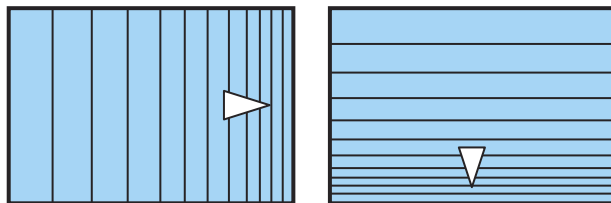

17. When you are finished, press **Menu**.

**Note:** If necessary, you can fine-tune the results of your Corner Wall adjustments using Point Correction.

**Parent topic:** [Image Shape](#)

### Related references

[Projector Feature Settings - Settings Menu](#)

### Related tasks

[Displaying a Test Pattern](#)

[Correcting Image Shape with Point Correction](#)

## Resizing the Image with the Zoom Button

1. Turn on the projector and display an image.
2. Press the **Zoom** button on the projector's control panel or remote control.

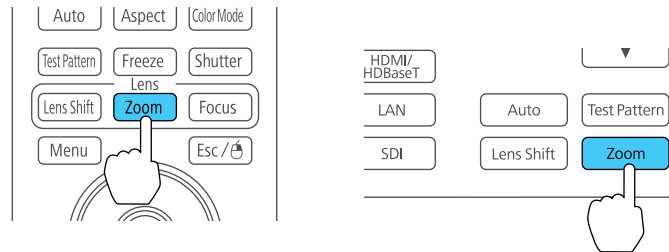

3. Press and hold the arrow buttons on the projector's control panel or remote control to resize the image.
4. Press the **Esc** button on the projector's control panel or remote control when finished.

**Parent topic:** [Using Basic Projector Features](#)

### Related tasks

[Displaying a Test Pattern](#)

## Focusing the Image Using the Focus Button

1. Turn on the projector and display an image.

2. Press the **Focus** button on the projector's control panel or remote control.

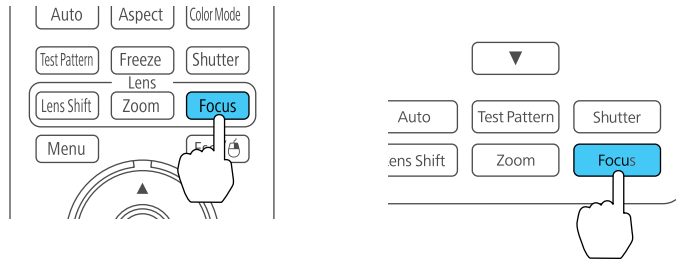

3. Press and hold the arrow buttons on the projector's control panel or remote control to adjust the focus.
4. Press the **Esc** button on the projector's control panel or remote control when finished.

#### [Focusing the Image with the Optional Short Throw Lens](#)

**Parent topic:** [Using Basic Projector Features](#)

#### **Related tasks**

[Displaying a Test Pattern](#)

## **Focusing the Image with the Optional Short Throw Lens**

If you installed the optional short throw lens (ELPLU02) and shifted the lens using the lens shift option, you can focus the image using the distortion ring.

**Note:** When using the short throw lens, select **ELPLU02** as the **Lens Type** setting in the Extended menu. If the image has shifted after making adjustments, re-position the image using the **Lens Shift** button. When adjusting the image height, position the image lower than where you want it to be and move it up using the arrow buttons. This will help prevent the image from moving down after adjustment.

1. Turn on the projector and display an image.

2. Carefully rotate the distortion ring all the way counterclockwise.

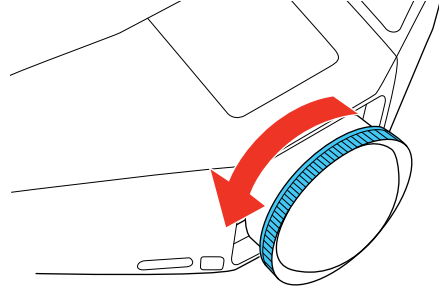

**Note:** Be careful not to move the short throw lens when adjusting it to prevent the projected image from shifting.

3. Press the **Focus** button on the projector's control panel or remote control.
4. Press and hold the arrow buttons to focus the image around the center of the lens.

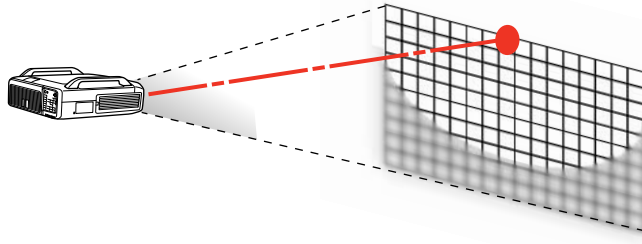

5. Rotate the distortion ring until the area around the edges of the image is also focused.

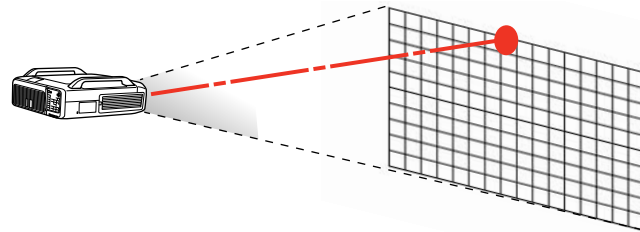

6. Press the **Focus** button again, then press the arrow buttons to focus the entire screen image.
7. If the image area shown in step 4 is out of focus, rotate the distortion ring to bring the area into focus.

**Parent topic:** [Focusing the Image Using the Focus Button](#)

**Related tasks**

[Adjusting the Image Position Using Lens Shift](#)

## Remote Control Operation

The remote control lets you control the projector from almost anywhere in the room, up to 98 feet (30 m) away. You can point it at the front or back of the projector.

Make sure that you aim the remote control at the projector's receivers within the angles listed here.

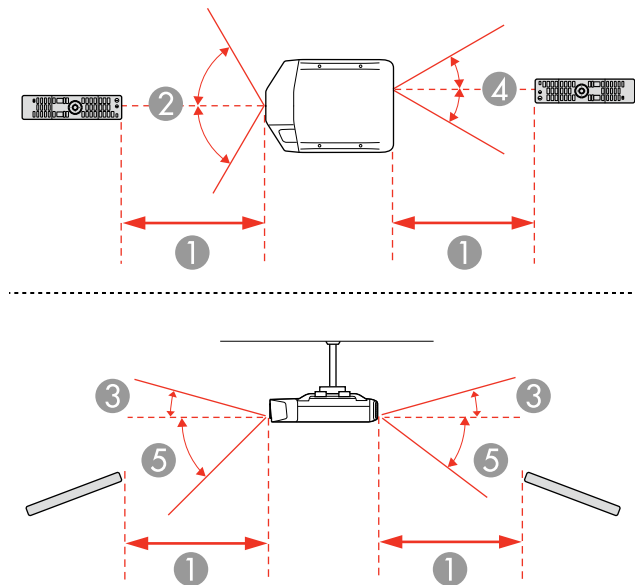

- 1 98 feet (30 m)
- 2  $\pm 60^\circ$
- 3  $+15^\circ$
- 4  $\pm 30^\circ$

**Note:** Avoid using the remote control in conditions with bright fluorescent lights or in direct sunlight, or the projector may not respond to commands. If you will not use the remote control for a long time, remove the batteries.

**Parent topic:** [Using Basic Projector Features](#)

**Related tasks**

[Replacing the Remote Control Batteries](#)

## Selecting an Image Source

If you connected multiple image sources to the projector, such as a computer and DVD player, you may want to switch from one image source to the other.

1. Make sure the connected image source you want to use is turned on.
2. For video image sources, insert a DVD or other video media and press its play button, if necessary.
3. Press the button for the source you want on the projector's control panel or remote control. If there is more than one port for that source, press the button again to cycle through the sources.

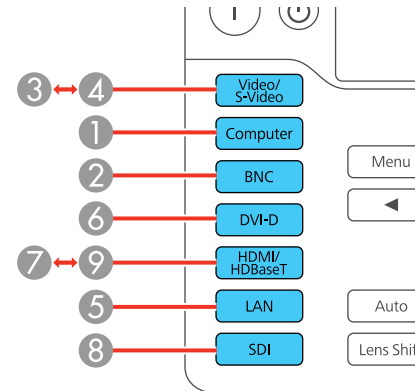
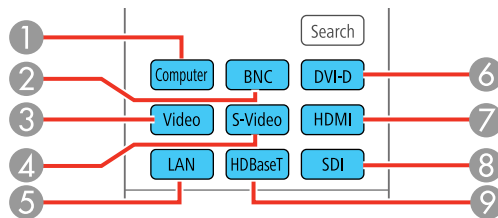

- 1 Computer port source
- 2 BNC port source
- 3 Video port source (composite video)

- 4 S-Video port source
- 5 Networked computer source
- 6 DVI-D port source
- 7 HDMI port source
- 8 SDI port source (PowerLite Pro Z9870UNL/Z10000UNL/Z10005UNL)
- 9 HDBaseT port source

Parent topic: [Using Basic Projector Features](#)

## Selecting the Lamp

You can select the lamps you want to turn on.

1. Press the **Menu** button.
2. Select the **Extended** menu and press **Enter**.

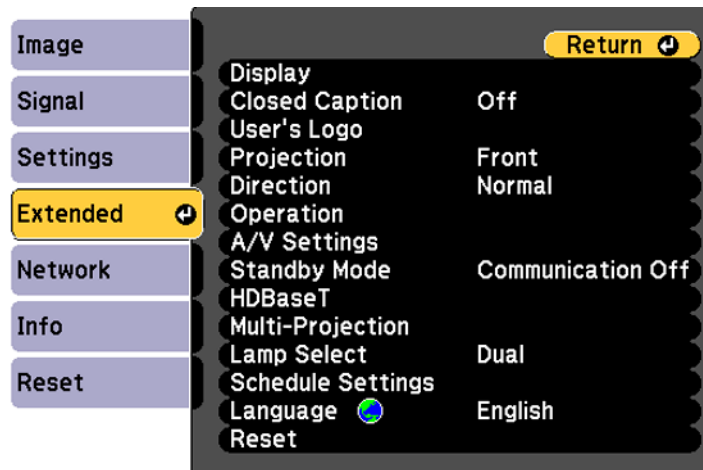

3. Select the **Lamp Select** setting and press **Enter**.

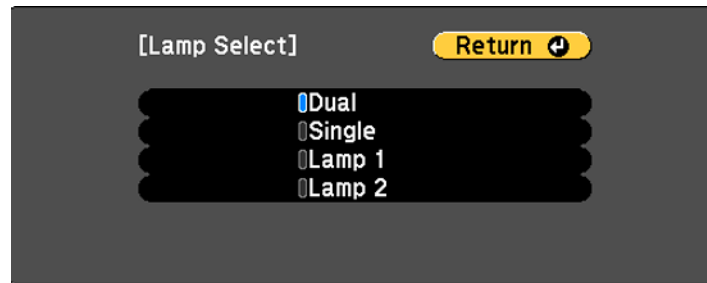

4. Use the arrow buttons on the projector or the remote control to select one of the following options:
  - **Dual** (default): Both lamps are on. If one lamp stops working, the other remains on.
  - **Single**: When the projector is turned on, the lamp with the fewest number of total operation hours turns on. If that lamp stops working, the other lamp turns on.
  - **Lamp 1**: Lamp 1 turns on. If Lamp 1 stops working, Lamp 2 turns on.
  - **Lamp 2**: Lamp 2 turns on. If Lamp 2 stops working, Lamp 1 turns on.
5. When you are finished, press the **Menu** button.

**Parent topic:** [Using Basic Projector Features](#)

## Projection Modes

Depending on how you positioned the projector, you may need to change the projection mode so your images project correctly.

- **Front** (default setting) lets you project from a table in front of the screen.
- **Front/Upside Down** flips the image over top-to-bottom to project upside-down from a wall or ceiling mount.
- **Rear** flips the image horizontally to project from behind a translucent screen.
- **Rear/Upside Down** flips the image over top-to-bottom and horizontally to project from the wall or ceiling and behind a translucent screen.

You can change the projection mode using the remote control or by changing the **Projection** setting in the **Extended** menu.

[Changing the Projection Mode Using the Menus](#)



Parent topic: [Using Basic Projector Features](#)

## Changing the Projection Mode Using the Menus

You can change the projection mode to flip the image over top-to-bottom and/or left-to-right using the projector menus.

1. Turn on the projector and display an image.
2. Press the **Menu** button.
3. Select the **Extended** menu and press **Enter**.

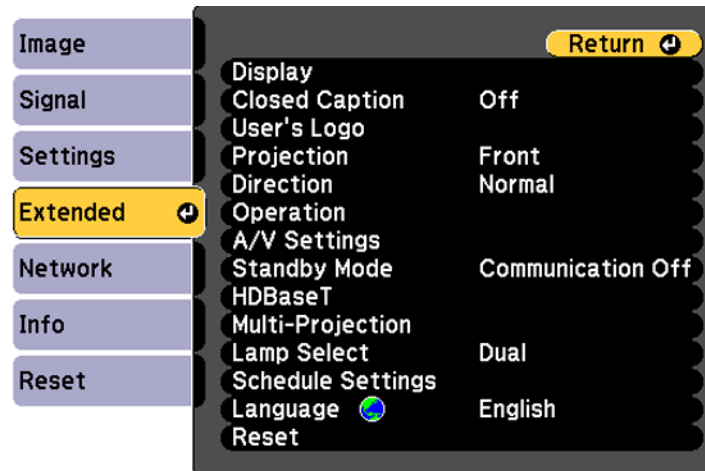

4. Select the **Projection** setting and press **Enter**.
5. Select a projection mode and press **Enter**.
6. Press **Menu** or **Esc** to exit the menus.

Parent topic: [Projection Modes](#)

## Image Aspect Ratio

The projector can display images in different width-to-height ratios called aspect ratios. Normally the input signal from your video source determines the image's aspect ratio. However, for certain images you can change the aspect ratio to fit your screen by pressing a button on the remote control.

If you always want to use a particular aspect ratio for a certain video input source, you can select it using the projector's menus.

[Changing the Image Aspect Ratio](#)

[Available Image Aspect Ratios](#)

**Parent topic:** [Using Basic Projector Features](#)

**Related references**

[Image Quality Settings - Image Menu](#)

## Changing the Image Aspect Ratio

You can change the aspect ratio of the displayed image to resize it.

**Note:** Set the Screen Type setting in the projector's Extended menu before changing the aspect ratio.

1. Turn on the projector and switch to the image source you want to use.
2. Press the **Aspect** button on the remote control.

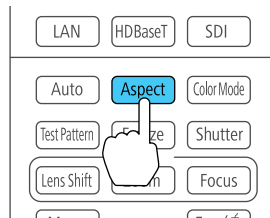

The shape and size of the displayed image changes, and the name of the aspect ratio appears briefly on the screen.

3. To cycle through the available aspect ratios for your input signal, press the **Aspect** button repeatedly.

**Parent topic:** [Image Aspect Ratio](#)

## Available Image Aspect Ratios

You can select the following image aspect ratios, depending on the selected Screen Type setting and the input signal from your image source.

**Note:** Black bands and cropped or stretched images may project in certain aspect ratios, depending on the aspect ratio and resolution of your input signal.

Screen Type setting	Available aspect ratios
<b>4:3</b>	Auto or Normal, 4:3, 6:9, Native*
<b>16:9</b>	Auto or Normal, Full, Zoom, Native
<b>16:10</b>	Auto or Normal, 16:9, Full, Zoom, Native

\*Available only when projecting computer images, or from sources connected to the **HDMI** or **HDBaseT** port

Aspect ratio setting	Description
<b>Auto</b>	Automatically sets the aspect ratio according to the input signal.
<b>Normal</b>	Displays images in the same aspect ratio of the input signal.
<b>4:3</b>	Displays images at a 4:3 aspect ratio.
<b>16:9</b>	Displays images at a 16:9 aspect ratio.
<b>Full</b>	Displays images using the full size of the projection area, but does not maintain the aspect ratio.
<b>Zoom</b>	Displays images using the full width of the projection area and maintains the aspect ratio of the image. Areas that exceed the edges of the projected screen are not projected.
<b>Native</b>	Displays images as is (aspect ratio and resolution are maintained). Areas that exceed the edges of the projected screen are not projected.

**Parent topic:** [Image Aspect Ratio](#)

**Related tasks**

[Setting the Screen Type](#)

## Color Mode

The projector offers different Color Modes to provide optimum brightness, contrast, and color for a variety of viewing environments and image types. You can select a mode designed to match your image and environment, or experiment with the available modes.

If you always want to use a particular color mode for a certain video input source, you can select it using the projector menus.

[Changing the Color Mode](#)

[Available Color Modes](#)

[Turning On Auto Iris](#)

**Parent topic:** [Using Basic Projector Features](#)

**Related references**

[Image Quality Settings - Image Menu](#)

## Changing the Color Mode

You can change the projector's Color Mode using the remote control to optimize the image for your viewing environment.

1. Turn on the projector and switch to the image source you want to use.
2. If you are projecting from a DVD player or other video source, insert a disc or other video media and press the play button, if necessary.
3. Press the **Color Mode** button on the remote control to change the Color Mode.

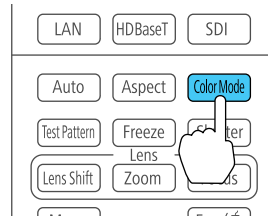

The image appearance changes and the name of the Color Mode appears briefly on the screen.

4. To cycle through all the available Color Modes for your input signal, press the **Color Mode** button repeatedly.

**Parent topic:** [Color Mode](#)

## Available Color Modes

You can set the projector to use these Color Modes, depending on the input source you are using:

Color Mode	Description
<b>Dynamic</b>	Best for projecting in a bright room
<b>Presentation</b>	Best for color presentations in a bright room
<b>Theatre</b>	Best for movies projected in a dark room
<b>Photo<sup>1</sup></b>	Best for still images projected in a bright room
<b>Sports<sup>2</sup></b>	Best for television images in a bright room
<b>sRGB</b>	Best for standard sRGB computer displays
<b>DICOM SIM<sup>1</sup></b>	Best for projecting X-ray photographs and other medical images
<b>Multi-Projection</b>	Best for projecting from multiple projectors (reduces the color tone difference between images)

<sup>1</sup> Only available when inputting RGB signals

<sup>2</sup> Only available when the input signal is component video, or when the input source is Video or S-Video

**Note:** The **DICOM SIM** Color Mode is for reference purposes only and should not be used to make medical diagnoses.

**Parent topic:** [Color Mode](#)

## Turning On Auto Iris

In certain color modes, you can turn on the Auto Iris setting to automatically optimize the image based on the brightness of the content you project.

1. Turn on the projector and switch to the image source you want to use.
2. Press the **Menu** button.

3. Select the **Image** menu and press **Enter**.

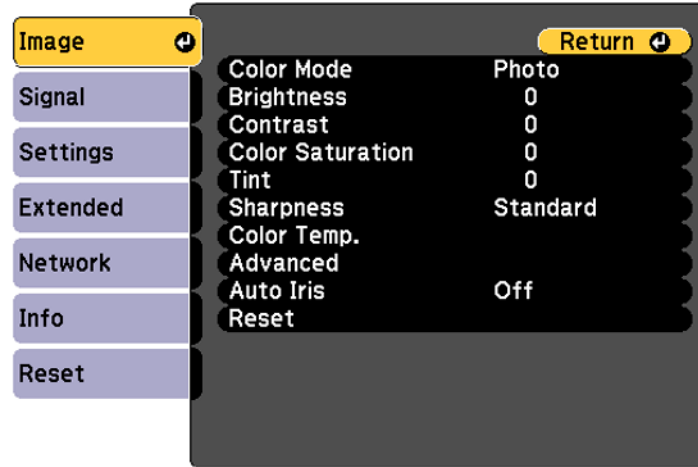

4. Select the **Auto Iris** setting and choose one of the following:
  - **High Speed** to adjust brightness as soon as the scene changes.
  - **Normal** for standard brightness adjustment.

**Note:** You can set **Auto Iris** for each Color Mode that supports the feature. The **Auto Iris** setting is disabled when the **Edge Blending** setting is **On**.

5. Press **Menu** or **Esc** to exit the menus.

Parent topic: [Color Mode](#)

## Setting the Date and Time

You can set the date and time for the projector.

1. Press the **Menu** button.
2. Select the **Extended** menu and press **Enter**.
3. Select the **Operation** setting and press **Enter**.
4. Select the **Date & Time** setting and press **Enter**.

You see a screen like this:

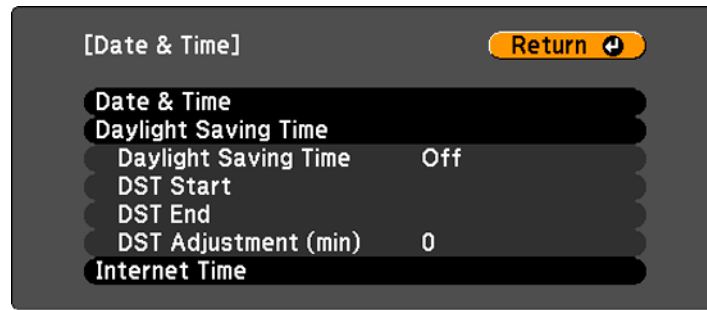

5. Select the **Date & Time** setting and press **Enter**.
6. Use the displayed keyboard to enter the date and time.
7. When you are finished, press **Menu**.

**Parent topic:** [Using Basic Projector Features](#)

---

# Adjusting Projector Features

Follow the instructions in these sections to use your projector's feature adjustments.

[Shutting Off the Picture Temporarily](#)

[Stopping Video Action Temporarily](#)

[Zooming Into and Out of Images](#)

[Projector Security Features](#)

[Using Multiple Projectors](#)

[Using Frame Interpolation](#)

[Viewing 3D Images](#)

[Saving Settings to Memory and Using Saved Settings](#)

[Scheduling Projector Events](#)

## Shutting Off the Picture Temporarily

You can temporarily turn off the projected picture if you want to redirect your audience's attention during a presentation. Any video action continues to run, however, so you cannot resume projection at the point that you stopped it.

1. Press the **Shutter** button on the projector's control panel or remote control to temporarily stop projection.

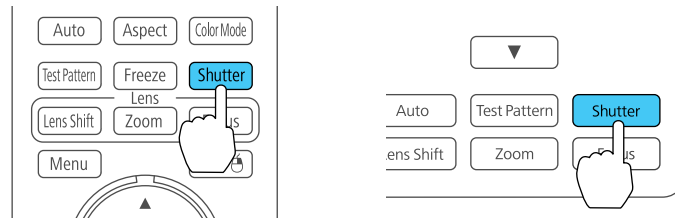

2. To turn the picture back on, press the **Shutter** button again.

**Parent topic:** [Adjusting Projector Features](#)

**Related references**

[Projector Setup Settings - Extended Menu](#)



## Stopping Video Action Temporarily

You can temporarily stop the action in a video or computer presentation and keep the current image on the screen. Any video action continues to run, however, so you cannot resume projection at the point that you stopped it.

1. Press the **Freeze** button on the remote control to stop the video action.

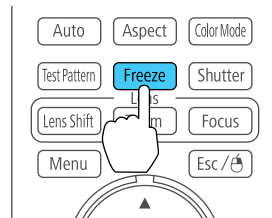

2. To restart the video action in progress, press **Freeze** again.

Parent topic: [Adjusting Projector Features](#)

## Zooming Into and Out of Images

You can draw attention to parts of a presentation by zooming into a portion of the image and enlarging it on the screen.

1. Press the **E-Zoom +** button on the remote control.

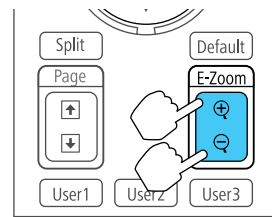

You see a crosshair on the screen indicating the center of the zoom area.

2. Use the following buttons on the remote control to adjust the zoomed image:
  - Use the arrow buttons to position the crosshair in the image area you want to zoom into.
  - Press the **E-Zoom +** button repeatedly to zoom into the image area, enlarging it as necessary.

- To pan around the zoomed image area, use the arrow buttons.
- To zoom out of the image, press the **E-Zoom –** button as necessary.
- To return to the original image size, press **Esc**.

**Parent topic:** [Adjusting Projector Features](#)

## Projector Security Features

You can secure your projector to deter theft or prevent unintended use by setting up the following security features:

- Password security to prevent the projector from being turned on, and prevent changes to the startup screen and other settings.
- Button lock security to block operation of the projector using the buttons on the control panel or remote control.
- Security cabling to physically cable the projector in place.

[Password Security Types](#)

[Locking the Projector's Buttons](#)

[Installing a Security Cable](#)

**Parent topic:** [Adjusting Projector Features](#)

## Password Security Types

You can set up these types of password security using one shared password:

- **Power On Protection** password prevents anyone from using the projector without first entering a password.
- **User's Logo Protection** password prevents anyone from changing the custom screen the projector can display when it turns on or when you use the A/V Mute feature. The presence of the custom screen discourages theft by identifying the projector's owner.
- **Network Protection** password prevents anyone from changing the network settings in the projector menus.
- **Time/Schedule Protection** password prevents anyone from changing the projector's time or schedule settings.

[Setting a Password](#)

[Selecting Password Security Types](#)

[Entering a Password to Use the Projector](#)

## Saving a User's Logo Image to Display

### Parent topic: Projector Security Features

#### Setting a Password

To use password security, you must set a password.

1. Hold down the **Freeze** button on the remote control for about ten seconds or until you see this menu.

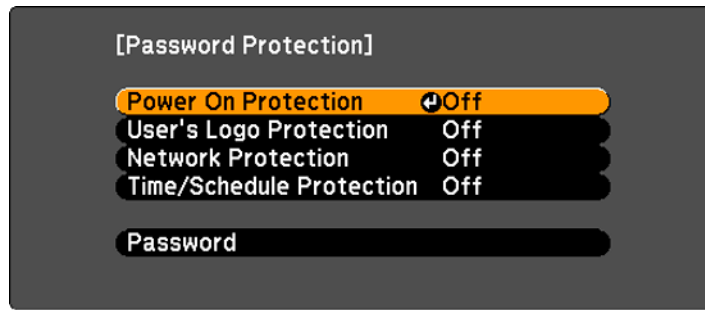

2. Press the down arrow to select **Password** and press **Enter**.  
You see the prompt "Change the password?".
3. Select **Yes** and press **Enter**.
4. Press and hold down the **Num** button on the remote control and use the numeric buttons to set a four-digit password.

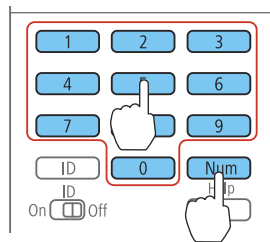

The password displays as \*\*\*\* as you enter it. Then you see the confirmation prompt.

5. Enter the password again.  
You see the message "Password accepted."

6. Press **Esc** to return to the menu.
7. Make a note of the password and keep it in a safe place in case you forget it.

Parent topic: [Password Security Types](#)

### Selecting Password Security Types

After setting a password, you see this menu, allowing you to select the password security types you want to use.

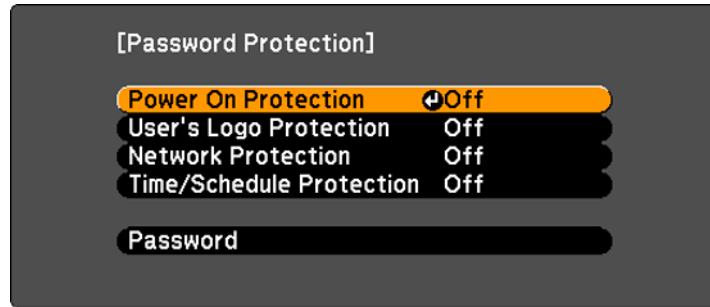

If you do not see this menu, hold down the **Freeze** button on the remote control for about ten seconds or until the menu appears.

1. To prevent unauthorized use of the projector, select **Power On Protection**, press **Enter**, select **On**, press **Enter** again, and press **Esc**.
2. To prevent changes to the User's Logo screen or related display settings, select **User's Logo Protection**, press **Enter**, select **On**, press **Enter** again, and press **Esc**.
3. To prevent changes to network settings, select **Network Protection**, press **Enter**, select **On**, press **Enter** again, and press **Esc**.
4. To prevent changes to the projector's time or schedule settings, select **Time/Schedule Protection**, press **Enter**, select **On**, press **Enter** again, and press **Esc**.

**Note:** Be sure to keep the remote control in a safe place; if you lose it, you will not be able to enter the password required to use the projector.

Parent topic: [Password Security Types](#)

## Entering a Password to Use the Projector

If a password is set up and a **Power On Protection** password is enabled, you see a prompt to enter a password whenever you turn on the projector.

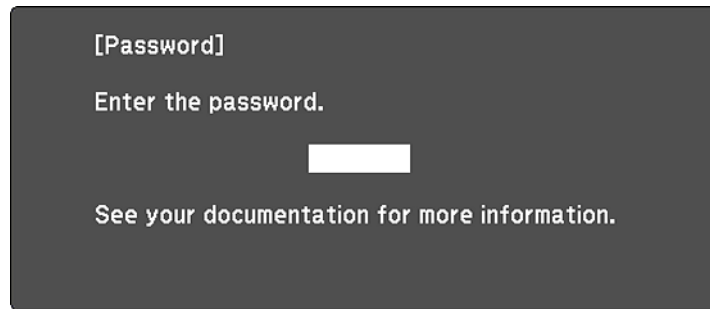

[0-9] :Enter

You must enter the correct password to use the projector.

1. Press and hold down the **Num** button on the remote control while you enter the password using the numeric buttons.

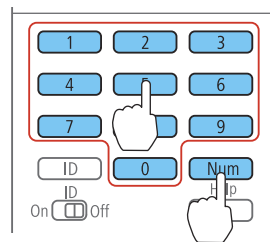

The password screen closes.

2. If the password is incorrect, the following may happen:
  - You see a "wrong password" message and a prompt to try again. Enter the correct password to proceed.
  - If you enter an incorrect password several times in succession, the projector displays a request code and a message to contact Epson Support. Do not attempt to enter the password again.

When you contact Epson Support, provide the displayed request code and proof of ownership for assistance in unlocking the projector.

**Parent topic:** [Password Security Types](#)

### Saving a User's Logo Image to Display

You can transfer an image to the projector and then display it whenever the projector turns on. You can also display the image when the projector is not receiving an input signal or when you temporarily stop projection (using the Shutter feature). This transferred image is called the User's Logo screen.

The image you select as the User's Logo can be a photo, graphic, or company logo, which is useful in identifying the projector's owner to help deter theft. You can prevent changes to the User's Logo by setting up password protection for it.

1. Display the image you want to project as the User's Logo.
2. Press the **Menu** button, select the **Extended** menu, and press **Enter**.

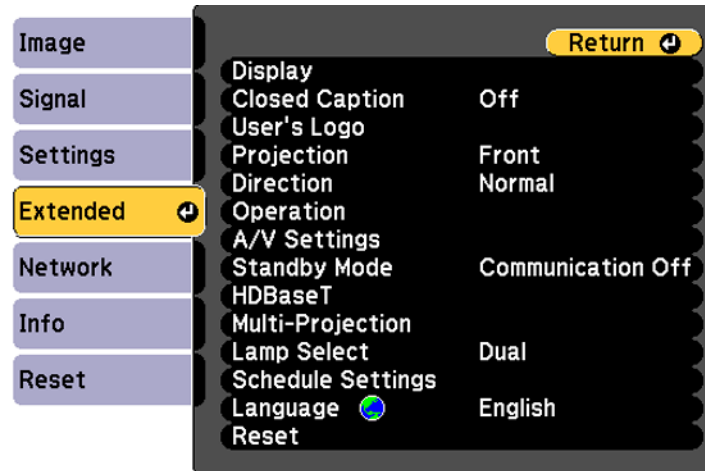

3. Select the **User's Logo** setting and press **Enter**.  
You see a prompt asking if you want to use the displayed image as a user's logo.
4. Select **Yes** and press **Enter**.  
You see a selection box overlaying your image.
5. Use the arrow buttons on the remote control or control panel to surround the image area you want to use as the User's Logo and press **Enter**.

You see a prompt asking if you want to select this image area.

6. Select **Yes** and press **Enter**. (If you want to change the selected area, select **No**, press **Enter**, and repeat the last step.)

You see the User's Logo zoom factor menu.

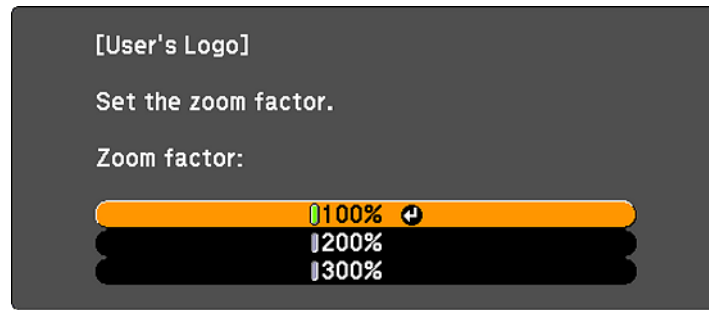

7. Select a zoom percentage and press **Enter**.

You see a prompt asking if you want to save the image as the User's Logo.

8. Select **Yes** and press **Enter**.

You see a completion message.

9. Press **Esc** to exit the message screen.

10. Select the **Extended** menu and press **Enter**.

11. Select **Display** and press **Enter**.

12. Select when you want to display the User's Logo screen:

- To display it whenever there is no input signal, select **Display Background** and set it to **Logo**.
- To display it whenever you turn the projector on, select **Startup Screen** and set it to **On**.

To prevent anyone from changing the User's Logo settings without first entering a password, set a password and enable User's Logo security.

Parent topic: [Password Security Types](#)

## Locking the Projector's Buttons

You can lock the buttons on the projector's control panel to prevent anyone from using the projector. You can lock all the buttons or all the buttons except the power button.

**Note:** You can also lock the buttons on the remote control by pressing and holding the **Help** button on the remote control for about five seconds. This function locks all remote control buttons except those used for basic operation.

1. Press the lock button on the control panel.

**Note:** To access the Control Panel Lock screen through the projector's menus, press the **Menu** button, select **Settings**, press **Enter**, select **Control Panel Lock**, and press **Enter**. If you want to prevent anyone from adjusting the lens, you can set the **Lens Operation Lock** setting in the **Settings** menu to **On**.

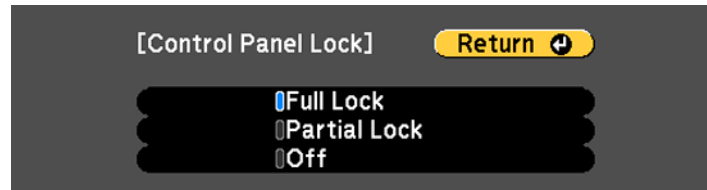

2. Select one of these control panel lock types and press **Enter**:
  - To lock all of the projector's buttons, select **Full Lock**.
  - To lock all buttons except the power button, select **Partial Lock**.You see a confirmation prompt.
3. Select **Yes** and press **Enter**.
4. Press the **Esc** button.

[Unlocking the Projector's Buttons](#)

**Parent topic:** [Projector Security Features](#)

**Related references**

[Projector Parts - Control Panel](#)

### Unlocking the Projector's Buttons

If the projector's buttons have been locked, hold the **Enter** button on the projector's control panel for seven seconds to unlock them.

**Note:** If the remote control buttons have been locked, hold the **Help** button on the remote control for 5 seconds to unlock them.



**Parent topic:** [Locking the Projector's Buttons](#)

## Installing a Security Cable

You can install two types of security cables on the projector to deter theft.

- Use the security slot on the projector to attach a Kensington lock. See your local computer or electronics dealer for purchase information.
- Use the handles on the projector to attach a wire cable and secure it to a room fixture or heavy furniture.

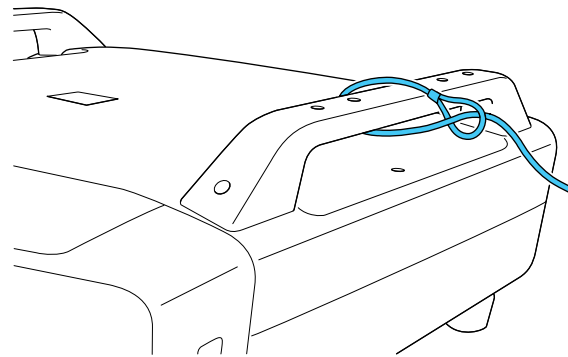

**Note:** Do not pass drop-prevention cables through the handles when mounting the projector on a wall or ceiling.

**Parent topic:** [Projector Security Features](#)

### Related references

[Projector Parts - Rear](#)

## Using Multiple Projectors

You can combine the projected images from two or more projectors to create one large image. The following two options are available:

- Project different images from each projector and create one seamless image

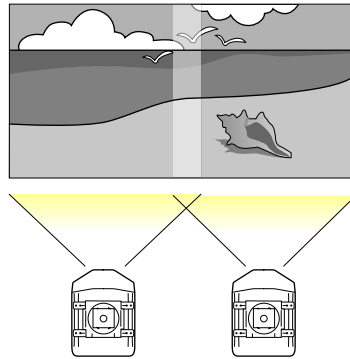

- Project the same image from each projector and use the Scale feature to create one seamless image

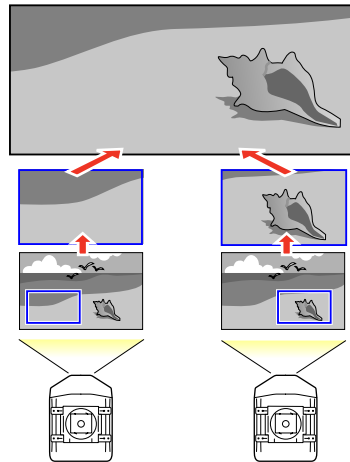

Follow the instructions in these sections to setup and project from multiple projectors.

[Projector Identification System for Multiple Projector Control](#)

[Adjusting the Position of the Projected Image From Multiple Projectors](#)

[Matching the Image Colors](#)

[Adjusting the Color Tone \(Color Uniformity\)](#)

[Adjusting the Color Convergence \(Panel Alignment\)](#)

[Scaling an Image](#)

[Projecting Two Images Simultaneously](#)

[Adjusting the Lamp's Brightness](#)

[Blending the Image Edges](#)

[Adjusting the Black Level](#)

[Copying Menu Settings Between Projectors](#)

**Parent topic:** [Adjusting Projector Features](#)

## **Projector Identification System for Multiple Projector Control**

You can operate multiple projectors using one remote control for more elaborate presentations. To do this, you assign an identification number to each projector and to the remote control. Then you can operate all the projectors at once or individually.

You can also match the colors displayed by any projectors you plan to use near each other.

**Caution:** Leave at least 20 inches (50 cm) of space between the projectors to prevent them from overheating.

[Setting the Projector ID](#)

[Setting the Remote Control ID](#)

**Parent topic:** [Using Multiple Projectors](#)

### **Setting the Projector ID**

If you want to control multiple projectors from a remote control, give each projector a unique ID.

1. Press the **Menu** button.
2. Select the **Extended** menu and press **Enter**.
3. Select the **Multi-Projection** menu and press **Enter**.

4. Select **Projector ID** and press **Enter**.

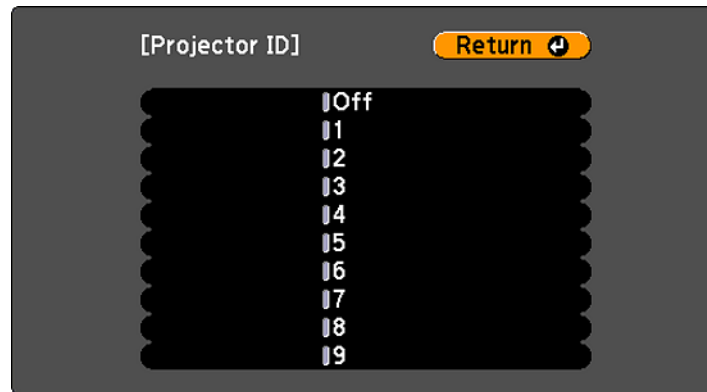

5. Use the arrow buttons on the remote control to select the identification number you want to use for the projector. Then press **Enter**.

Repeat these steps for all the other projectors you want to operate from one remote control.

**Parent topic:** [Projector Identification System for Multiple Projector Control](#)

### Setting the Remote Control ID

The remote control's ID is set to **0** by default so it can operate any compatible projector. If you want to set the remote control to operate only a particular projector, you need to set the remote control's ID to match the projector's ID.

1. Turn on the projector you want the remote control to operate with exclusively.
2. Set the remote control **ID** switch to **On**.

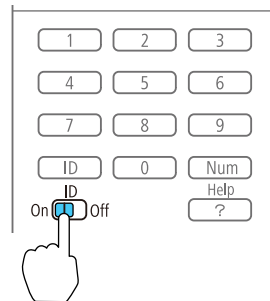

3. Hold down the **ID** button on the remote control while you press the numeric button that matches the projector's ID. Then release the buttons.

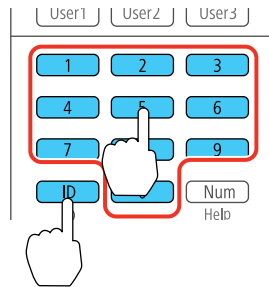

**Note:** If you don't know the projector's ID, hold down the **ID** button and press the **Help** button to temporarily display the projector's ID on the screen. If the batteries are left out of the remote control for an extended period, the remote control ID returns to its default setting.

**Parent topic:** [Projector Identification System for Multiple Projector Control](#)

## Adjusting the Position of the Projected Image From Multiple Projectors

If you need to adjust the position of a projected image from multiple projectors, perform the adjustments in the order listed here.

**Note:** You can display a pattern to aid in adjusting the projected image using the Settings menu.

1. Adjust the projector's physical position and angle to the screen.
2. Use the projector's lens shift and zoom features.

**Note:** Wait 30 minutes after turning on the projector before setting the lens shift and zoom for maximum accuracy.

3. Adjust the image shape using the Geometric Correction settings.

**Parent topic:** [Using Multiple Projectors](#)

### Related concepts

[Projector Placement](#)

## Related tasks

[Displaying a Test Pattern](#)

[Adjusting the Image Position Using Lens Shift](#)

[Resizing the Image with the Zoom Button](#)

[Correcting Image Shape with Quick Corner](#)

[Correcting Image Shape with Point Correction](#)

## Matching the Image Colors

You can match the display quality of multiple projectors that will project next to each other.

**Note:** Make sure you select **Multi-Projection** for the color mode. Brightness and colors may not match exactly even after performing the steps below.

1. Press the **Menu** button.
2. Select the **Extended** menu and press **Enter**.
3. Select the **Multi-Projection** setting and press **Enter**.
4. Select the **Color Matching** setting and press **Enter**.

You see this screen:



**Note:** Press **Enter** to toggle between the projected image and the adjustment screen.

5. Set the **Adjustment Level** setting to **1** and press **Enter**.
6. Set the remote control ID to match the second projector.
7. Access the Extended menu **Color Matching** setting on the second projector and set the **Adjustment Level** setting to **1**.
8. Adjust the color tone settings for **Red**, **Green**, and **Blue** on both projectors in the same way.

- Adjust the **Brightness** setting on the projector with the darkest display so it matches the lighter display, and press **Enter**. (You may need to switch the remote control ID back and forth to make adjustments to each projector in all of these steps.)
- Change the **Adjustment Level** setting to **5** on each projector, but this time match the lighter display to the darker one.
- Adjust the **Brightness** setting on **Adjustment Level 2, 3, and 4** in the same way.
- If you need to match more projectors, repeat these steps matching projector 3 to projector 2, 4 to 3, and so on.

Parent topic: [Using Multiple Projectors](#)

Related concepts

[Color Mode](#)

## Adjusting the Color Tone (Color Uniformity)

You can use the Color Uniformity feature to manually adjust the color tone balance in the projected image.

- Press the **Menu** button.
- Select the **Extended** menu and press **Enter**.

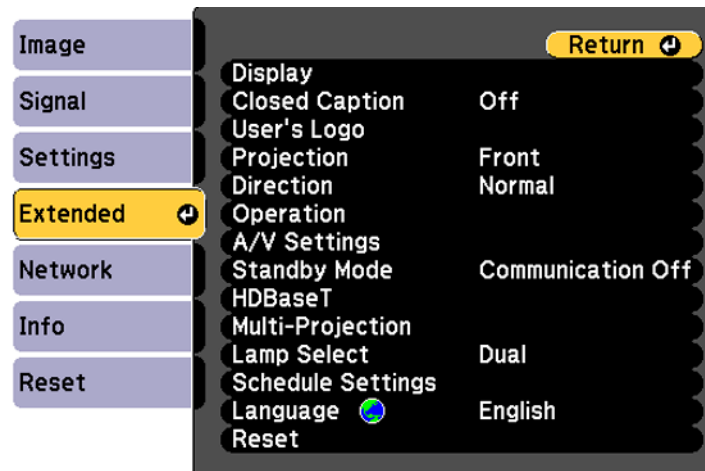

- Select the **Display** or **Multi-Projection** setting and press **Enter**.

4. Select the **Color Uniformity** setting and press **Enter**.
5. Press **Enter** and select **On**.
6. Press **Esc**.
7. Select the **Adjustment Level** setting and press **Enter**.
8. Press the right and left arrow buttons to adjust the level, then press **Esc**.
9. Select the **Start Adjustments** setting and press **Enter**.

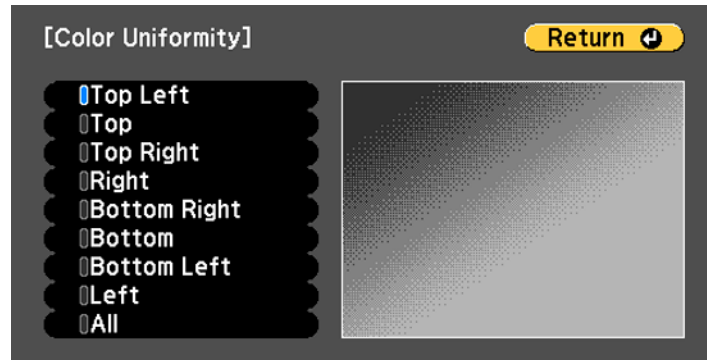

10. Select the area of the screen that you want to adjust and press **Enter**.
11. Select the color (**Red**, **Green**, or **Blue**) you want to adjust, and use the left arrow button to weaken the color tone and the right arrow button to strengthen the color tone.
12. Press **Esc**.
13. Repeat steps 10 and 11 for each area you want to adjust.
14. When you are finished, press the **Menu** button.

**Parent topic:** [Using Multiple Projectors](#)

## Adjusting the Color Convergence (Panel Alignment)

You can use the Panel Alignment feature to manually adjust the color convergence (the alignment of the red, green and blue colors) in the projected image.

**Note:** Allow your projector to warm up for at least 10 to 15 minutes and make sure the image is in focus before you use the Panel Alignment feature. The projected image size should be at least 60 inches (152



cm) diagonally and the projection surface should not be colored or textured; otherwise the adjustment grids are difficult to align.

1. Press the **Menu** button.
2. Select the **Extended** menu and press **Enter**.

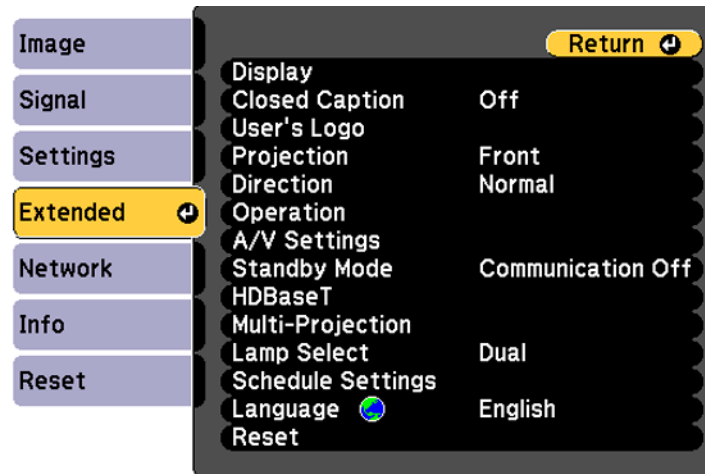

3. Select the **Display** setting and press **Enter**.
4. Select the **Panel Alignment** setting and press **Enter**.
5. Press **Enter** and select **On**.
6. Press **Esc**.
7. Select the **Select Color** setting and choose one of the following:
  - **R** to adjust the red color convergence
  - **B** to adjust the blue color convergence

**Note:** You can adjust only the red or blue color convergence; you cannot adjust the standard green color panel.

8. Select the **Pattern Color** setting and press **Enter**.
9. Select the pattern you want to use and press **Esc**.

10. Select **Start Adjustments** and press **Enter** twice.

You see this screen:

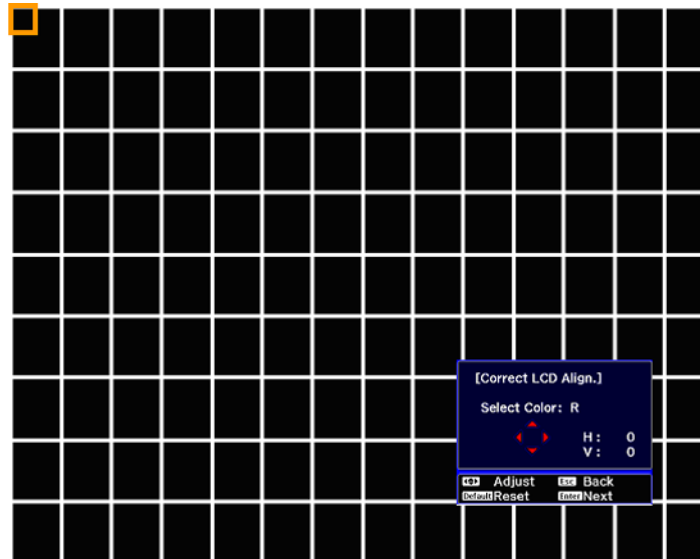

11. Use the arrow buttons on the remote control to adjust the color alignment in the corner of the screen highlighted by the orange box.
12. Press the **Enter** button to move to the next corner of the screen.
13. When you are finished adjusting each corner of the screen, press **Enter**.

You see this screen:

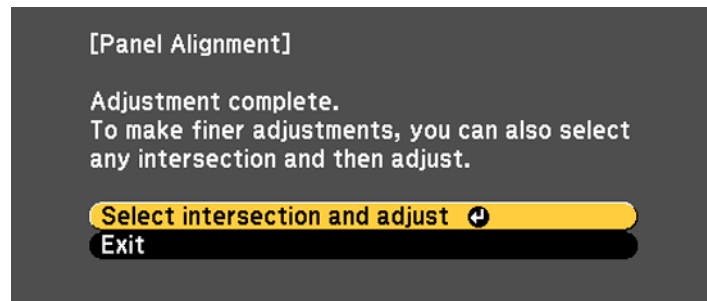

14. Do one of the following:

- If your projector's panel alignment is now correct, select **Exit** and press **Enter** to return to the Panel Alignment menu.
- If your projector needs additional panel alignment, select **Select intersection and adjust** and press **Enter**. Use the arrow keys on the remote control to highlight the corner of any box on the screen that is misaligned and press **Enter** to adjust the color convergence. Repeat this step as necessary.

Parent topic: [Using Multiple Projectors](#)

## Scaling an Image

You can project the same image from multiple projectors and use the Scale feature to crop and combine them into one large image.

1. Press the **Menu** button.
2. Select the **Signal** menu and press **Enter**.
3. Select the **Scale** setting and press **Enter**.

You see this screen:

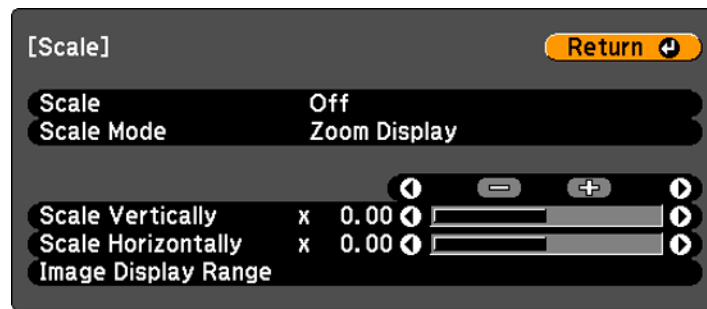

4. Select the **Scale** setting and select **On**.

5. Select the **Scale Mode** setting and select one of the following options:

- **Zoom Display:** Maintains the image aspect ratio as you scale the image



- **Full Display:** Adjusts the image to the projector's screen size as you scale the image

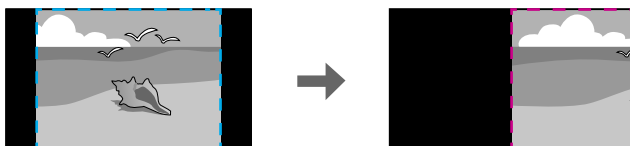
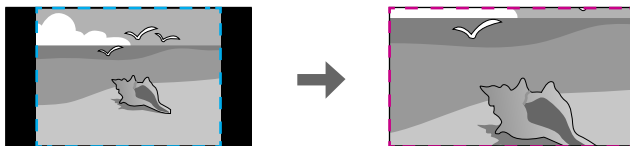

6. Select one or more of the following scaling options and adjust it as necessary:

- **- or +:** Scales the image horizontally and vertically at the same time
- **Scale Vertically:** Scales the image vertically only
- **Scale Horizontally:** Scales the image horizontally only

7. Select the **Image Display Range** setting and use the arrow buttons to adjust the coordinates and size of each image as you view the screen.

8. When you are finished, press the **Menu** button.

Parent topic: [Using Multiple Projectors](#)

## Projecting Two Images Simultaneously

You can use the split screen feature to simultaneously project two images from different image sources next to each other. You can control the split screen feature using the remote control or the projector menus.

**Note:** While you use the split screen feature, other projector features may not be available and some settings may be automatically applied to both images.

1. Press the **Split** button on the remote control.

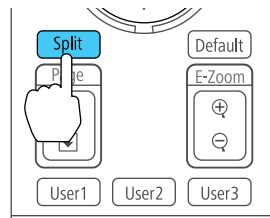

The currently selected input source moves to the left side of the screen.

2. Press the **Menu** button.

You see this screen:

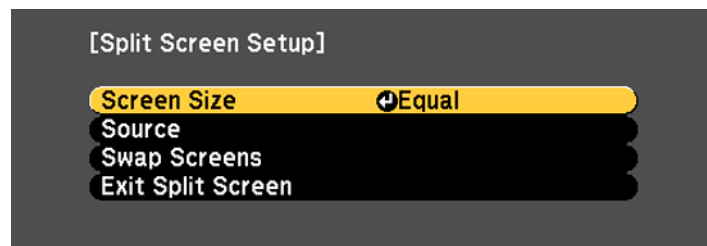

3. To select an input source for the other image, select the **Source** setting, press **Enter**, select the input source, select **Execute**, and press **Enter**. (You can also change image sources, if necessary.)
4. To switch the images, select the **Swap Screens** setting and press **Enter**.

5. To change the image sizes, select the **Screen Size** setting, press **Enter**, select a sizing option, press **Enter**, and press **Menu** to exit.

**Note:** Depending on the video input signals, the images may not appear at the same size even if you choose the **Equal** setting.

6. To exit the split screen feature, press the **Split** or **Esc** button.

**Parent topic:** [Using Multiple Projectors](#)

## Adjusting the Lamp's Brightness

When projecting with multiple projectors, you must adjust the brightness setting so that all projectors are as bright as the darkest lamp.

**Note:** Even after adjusting the brightness levels, the brightness of each lamp may not match exactly.

**Note:** You cannot adjust the brightness level in portrait projection.

1. Turn on all the projectors and display the same image.
2. Select **Normal** for the **Power Consumption** setting.
3. Select **Multi-Projection** or **3D Multi-Projection** (for 3D images) for the color mode.
4. Press the **Menu** button.
5. Select the **Extended** menu and press **Enter**.
6. Select the **Multi-Projection** setting and press **Enter**.
7. Select the **Brightness Level** setting and press **Enter**.
8. Select a brightness level.
9. Press **Esc** to return to the previous screen.

**Parent topic:** [Using Multiple Projectors](#)

### Related concepts

[Color Mode](#)

### Related references

[Projector Feature Settings - Settings Menu](#)

## Blending the Image Edges

You can use the projector's Edge Blending feature to create a seamless image from multiple projectors.

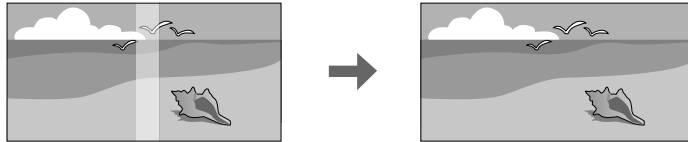

1. Press the **Menu** button.
2. Select the **Extended** menu and press **Enter**.
3. Select the **Multi-Projection** setting and press **Enter**.
4. Select the **Edge Blending** setting and press **Enter**.

You see this screen:

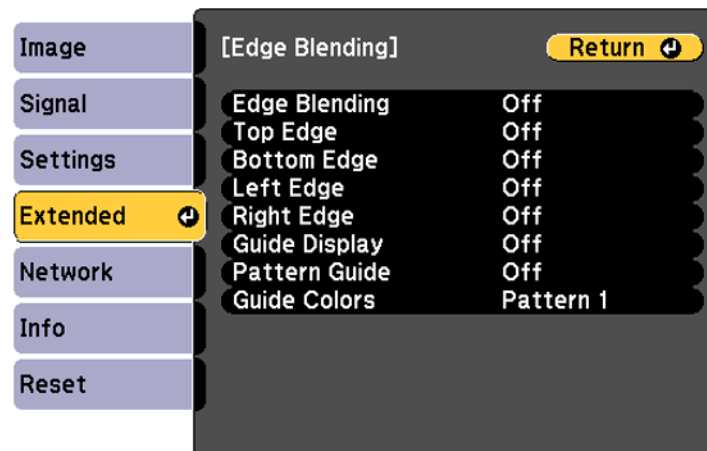

5. Turn on the **Edge Blending**, **Guide Display**, and **Pattern Guide** settings.

**Note:** If the projected guide is unclear, try changing the **Guide Colors** setting.

6. Select the edge you want to blend and press **Enter**.

You see a screen like this:



7. Select the **Blending** setting and select **On**.
8. Select the **Blend Range** setting and select the width of the blended area.  
Set the range so that the displayed guides are at the edges of the overlapping area between the two images.

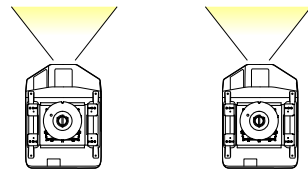
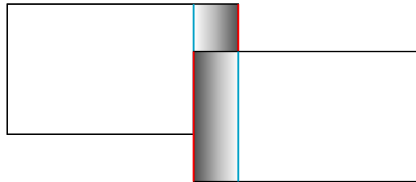

9. Press **Esc** to go back to the previous screen.
10. When the edges are blended, turn off the **Guide Display** and **Pattern Guide** settings to check the final settings.
11. When you are finished, press the **Menu** button.

**Parent topic:** [Using Multiple Projectors](#)



## Adjusting the Black Level

When two images overlap, the overlapping area can appear differently from the areas that do not overlap. You can use the projector's Black Level setting to make the difference less noticeable.

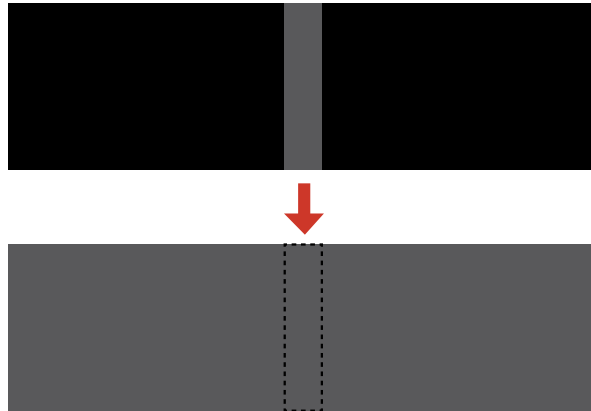

**Note:** You cannot adjust the black level when a test pattern displayed. The brightness and tone of the overlapping areas may differ from the rest of the image even after adjusting the black level.

1. Press the **Menu** button.
2. Select the **Extended** menu and press **Enter**.
3. Select the **Multi-Projection** setting and press **Enter**.
4. Select the **Black Level** setting and press **Enter**.

You see this screen:

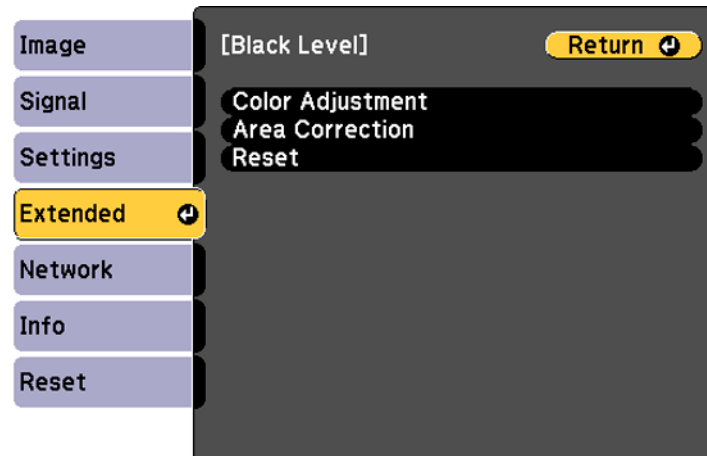

5. Select the **Color Adjustment** setting and press **Enter**.

You see this screen:



6. Adjust the brightness and tone of the areas that do not overlap to match the areas that overlap using the displayed adjustment sliders.

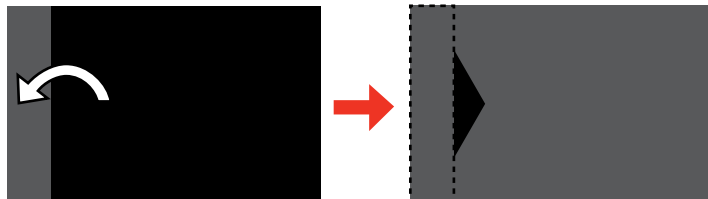

7. Press the **Esc** button to return to the Black Level menu screen.
8. Select the **Area Correction** setting and press **Enter**.

You see a screen like this displaying the points you can use to set the range for black level:

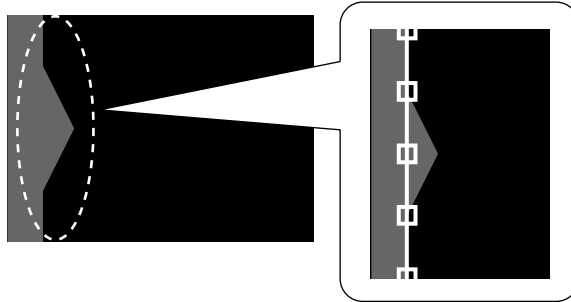

**Note:** The points displayed differ depending on the **Edge Blending** and **Point Correction** settings.

9. Use the arrow buttons to select an adjustment point and press the **Enter** button.  
The selected point turns orange.

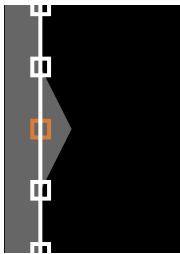

10. Use the arrow buttons to move the point to the edge of the adjustment area.

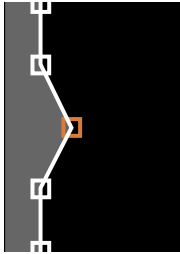

11. To move another point, press the **Esc** button and repeat the previous two steps.

12. When you are finished, press the **Esc** button twice.

13. When you see the confirmation message, select **Yes** to return to the Black Level menu screen.

14. When you are finished, press the **Menu** button.

**Note:** Changing any of the **Edge Blending** settings resets the **Black Level** setting to its default value.

**Parent topic:** [Using Multiple Projectors](#)

## Copying Menu Settings Between Projectors

After you select menu settings for your projector, you can transfer them to another projector of the same model.

**Note:** Any saved User's Logo setting on the projector will transfer to the other projector.

The following settings will not transfer between projectors:

- Info menu items
- Network menu settings other than those in the Mail and Others menus

[Saving Settings to a USB Flash Drive](#)

[Transferring Settings From a USB Flash Drive](#)

[Saving Settings to a Computer](#)

[Transferring Settings From a Computer](#)

Parent topic: [Using Multiple Projectors](#)

### Saving Settings to a USB Flash Drive

You can save the projector settings you want to transfer to a USB flash drive.

**Note:** Use an empty flash drive. If the drive contains other files, the transfer may not complete correctly.

1. Turn off the projector and unplug the power cord from the projector's power inlet.
2. Insert the flash drive into the wireless LAN module port.

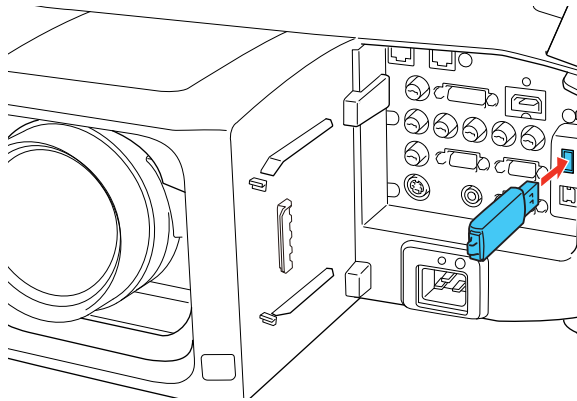

**Note:** Connect the flash drive directly to the projector. Do not use a hub.

3. Press and hold the **Esc** button on the control panel or remote control as you connect the power cord to the projector's power inlet.

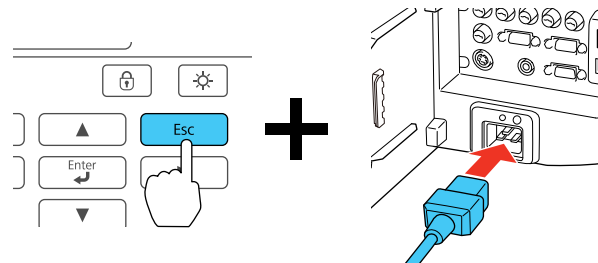

4. When the power, Status, Lamp, and Temp lights turn on, release the **Esc** button.

The lights flash to indicate that settings are transferring to the flash drive. When the lights stop flashing, the power light turns blue and the projector enters standby mode.

**Caution:** Do not unplug the power cord or remove the flash drive while the lights are flashing. This could damage the projector.

5. Once the projector enters standby mode, remove the flash drive.

**Parent topic:** [Copying Menu Settings Between Projectors](#)

### Transferring Settings From a USB Flash Drive

After saving projector settings to a USB flash drive, you can transfer them to another projector of the same model.

**Note:** Make sure the USB flash drive contains only a single settings transfer from another projector of the same model. The settings are contained in a file called **pjconfdata.bin**. If the drive contains other files, the transfer may not complete correctly.

Do not adjust image settings on a projector until after you transfer settings to it. Otherwise, you may have to repeat your adjustments.

1. Turn off the projector and unplug the power cord from the projector's power inlet.
2. Insert the flash drive into the wireless LAN module port.

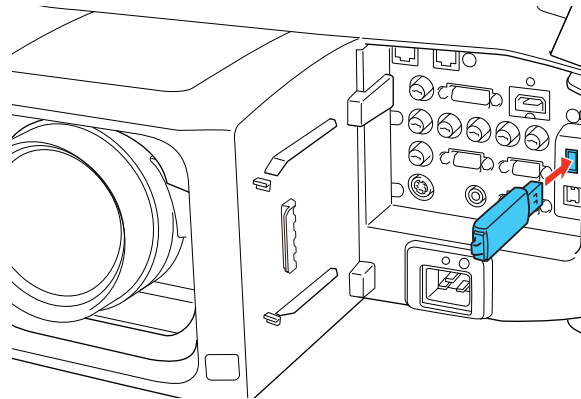

**Note:** Connect the flash drive directly to the projector. Do not use a hub.

3. Press and hold the **Menu** button on the control panel or remote control as you connect the power cord to the projector's power inlet.

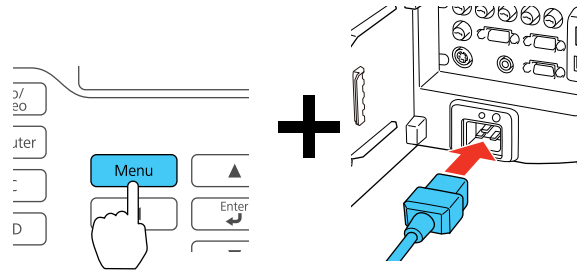

4. When the power, Lamp, and Temp lights turn on, release the **Menu** button.  
The lights flash to indicate that settings are transferring to the projector. When the lights stop flashing, the power light turns blue and the projector enters standby mode.

**Caution:** Do not unplug the power cord or remove the flash drive while the lights are flashing. This could damage the projector.

5. Once the projector enters standby mode, remove the flash drive.

**Parent topic:** [Copying Menu Settings Between Projectors](#)

### **Saving Settings to a Computer**

You can save the projector settings you want to transfer to a computer.

Your computer must be running one of the following operating systems:

- Windows Vista
- Windows 7
- Windows 8.x
- OS X 10.5.8
- OS X 10.6.x
- OS X 10.7.x
- OS X 10.8.x
- OS X 10.9.x

- OS X 10.10.x

1. Turn off the projector and unplug the power cord from the projector's power inlet.
2. Connect a USB cable to your projector's **Service** port.

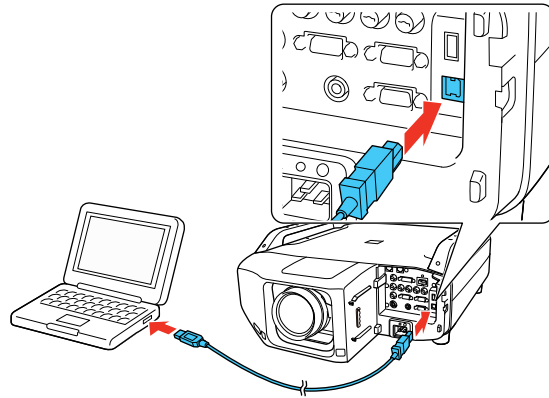

3. Connect the other end to any available USB port on your computer.
4. Press and hold the **Esc** button on the control panel or remote control as you connect the power cord to the projector's power inlet.

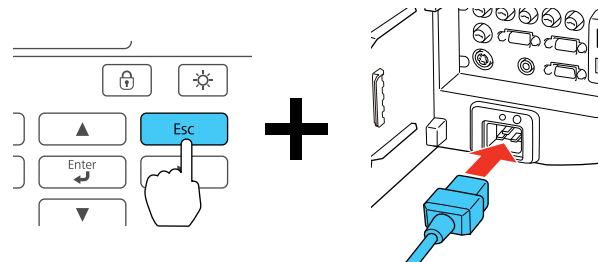

5. When the power, Status, Lamp, and Temp lights turn on, release the **Esc** button.  
The projector shows up as a removable disk on your computer.
6. Open the removable disk and copy the **pjconfdata.bin** file to your computer.



7. Once the file has copied, do one of the following:
  - **Windows:** Open the **My Computer**, **Computer**, or **Windows Explorer** utility. Right-click the name of your projector (listed as a removable disk) and select **Eject**.
  - **OS X:** Drag the removable disk icon for your projector from the desktop into the trash.

The projector enters standby mode.

**Parent topic:** [Copying Menu Settings Between Projectors](#)

### **Transferring Settings From a Computer**

After saving projector settings to a computer, you can transfer them to another projector of the same model.

Your computer must be running one of the following operating systems:

- Windows Vista
- Windows 7
- Windows 8.x
- OS X 10.5.8
- OS X 10.6.x
- OS X 10.7.x
- OS X 10.8.x
- OS X 10.9.x
- OS X 10.10.x

Do not adjust image settings on a projector until after you transfer settings to it. Otherwise, you may have to repeat your adjustments.

1. Turn off the projector and unplug the power cord from the projector's power inlet.

2. Connect a USB cable to your projector's **Service** port.

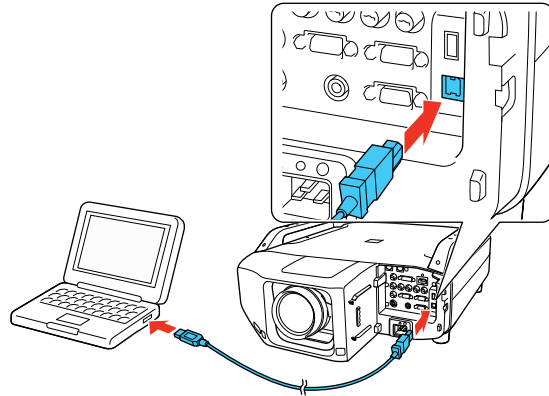

3. Connect the other end to any available USB port on your computer.
4. Press and hold the **Menu** button on the control panel or remote control as you connect the power cord to the projector's power inlet.

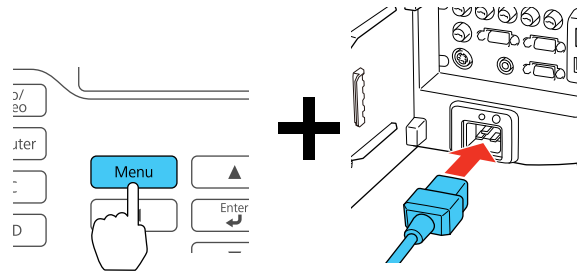

5. When the power, Status, Lamp, and Temp lights turn on, release the **Menu** button. The projector shows up as a removable disk on your computer.
6. Copy the **pjconfdata.bin** file from your computer to the removable disk.

**Note:** Do not copy any other files to the removable disk.

- Once the file has copied, do one of the following:
  - Windows:** Open the **My Computer**, **Computer**, or **Windows Explorer** utility. Right-click the name of your projector (listed as a removable disk) and select **Eject**.
  - OS X:** Drag the removable disk icon for your projector from the desktop into the trash.The power, Status, Lamp, and Temp lights start flashing to indicate that the projector's settings are being updated. When the lights stop flashing, the power light turns blue and the projector enters standby mode.

**Caution:** Do not unplug the power cord while the lights are flashing. This could damage the projector.

Parent topic: [Copying Menu Settings Between Projectors](#)

## Using Frame Interpolation

You can use the projector's Frame Interpolation feature to smooth fast-moving video by comparing consecutive image frames and inserting an intermediate image frame between them (PowerLite Pro Z9750UNL/Z9870UNL/Z10000UNL/Z10005UNL).

- Press the **Menu** button.
- Select the **Signal** menu and press **Enter**.

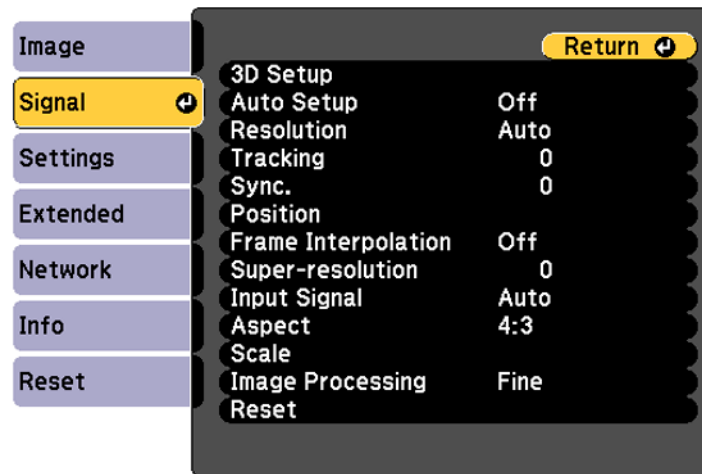

3. Select the **Frame Interpolation** setting and press **Enter**.

You see a screen like this:

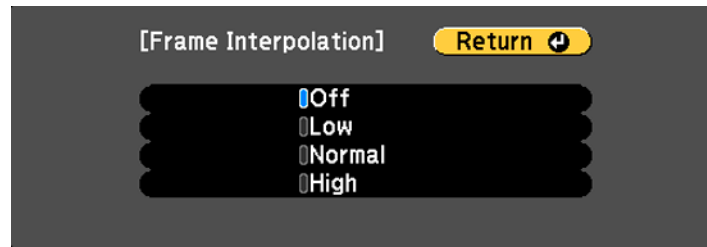

4. Select the level of interpolation and press **Enter**.
5. When you are finished, press the **Menu** button.

**Note:** If your resulting images contain noise, turn off the **Frame Interpolation** setting.

**Parent topic:** [Adjusting Projector Features](#)

## Viewing 3D Images

Using an optional polarizer kit (ELPPL01), passive 3D glasses (ELPGS02A/ELPGS02B), and two installation frames (ELPMB44), you can use two projectors to project and view passive 3D images. See the instructions supplied with the optional equipment for setup and use.

For optimal viewing, select the **3D Setup** setting from the Signal menu and select one of the 3D color modes in the **3D Images** menu.

**Parent topic:** [Adjusting Projector Features](#)

### Related concepts

[Color Mode](#)

### Related references

[Input Signal Settings - Signal Menu](#)

[Optional Equipment and Replacement Parts](#)

## Saving Settings to Memory and Using Saved Settings

You can save customized settings for each of your video inputs and then select the saved settings whenever you want to use them.

1. Turn on the projector and display an image.
2. Press the **Menu** button.
3. Select the **Settings** menu and press **Enter**.
4. Select the **Memory** setting and press **Enter**.

You see this screen:

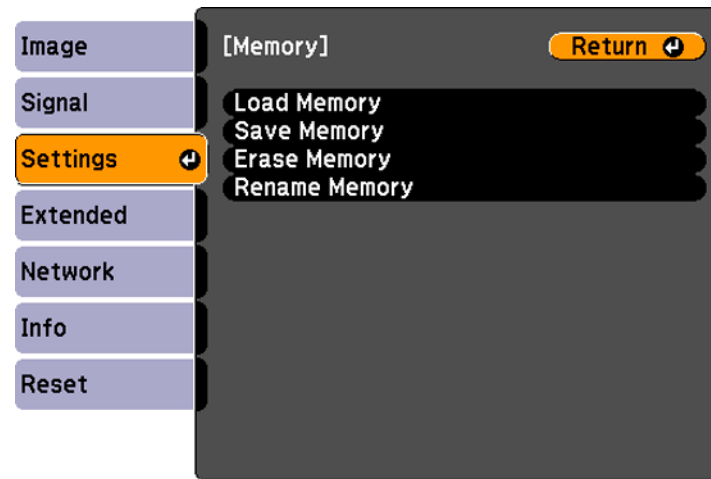

5. Select one of the following options:
  - **Load Memory:** Overwrites your current settings with saved settings
  - **Save Memory:** Saves your current settings to memory (10 memories with different names are available)  
  
**Note:** A memory name that has already been used is indicated by a blue mark. Saving over a previously saved memory overwrites the settings with your current settings.
  - **Erase Memory:** Erases the selected memory settings
  - **Rename Memory:** Renames a saved memory
6. Press **Esc** to exit.

**Parent topic:** [Adjusting Projector Features](#)

## Scheduling Projector Events

You can save a projector command, such as turning the projector on or off or switching input sources, as an "event". You can schedule when you want the projector to automatically execute the command.

**Note:** The Time/Schedule Protection setting in the Password Protection menu must be turned off to schedule an event.

[Saving a Scheduled Event](#)

[Viewing Scheduled Events](#)

[Editing a Scheduled Event](#)

**Parent topic:** [Adjusting Projector Features](#)

### Saving a Scheduled Event

You can select projector commands you want to perform and schedule them as an event.

1. Press the **Menu** button.
2. Select the **Extended** menu and press **Enter**.
3. Select the **Schedule Settings** setting and press **Enter**.  
The Schedule Settings screen appears.
4. Select the **Schedule** menu and press **Enter**.
5. Select **Add New** and press **Enter**.
6. In the Event Settings section, select the events you want to have occur. (Select **No Change** for events that you do not want to occur.)
7. In the Date/Time Settings section, set the date and time for the scheduled events to occur.
8. When you are finished, select **Save** and press **Enter**.
9. To schedule more events, repeat the previous 4 steps.
10. Select **Setup complete** and select **Yes** to save your changes.

**Parent topic:** [Scheduling Projector Events](#)

### Viewing Scheduled Events

You can view any currently scheduled events.

1. Press the **Menu** button.

2. Select the **Extended** menu and press **Enter**.
3. Select the **Schedule Settings** setting and press **Enter**.

You see a screen like this:

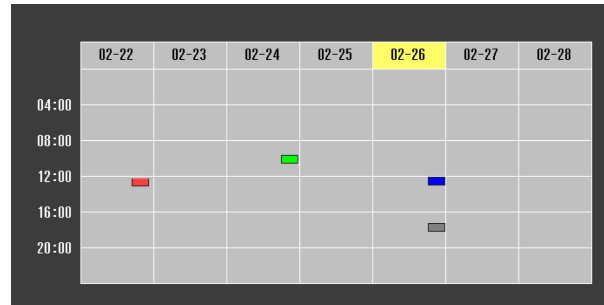

The colored boxes in the calendar indicate the following about the scheduled events:

- Blue box: One-time event
- Red box: Reoccurring event
- Green box: Communication is on/off
- Grey box: Event is invalid

Parent topic: [Scheduling Projector Events](#)

## Editing a Scheduled Event

You can edit any currently scheduled event.

1. Press the **Menu** button.
2. Select the **Extended** menu and press **Enter**.
3. Select the **Schedule Settings** setting and press **Enter**.

You see a screen like this:

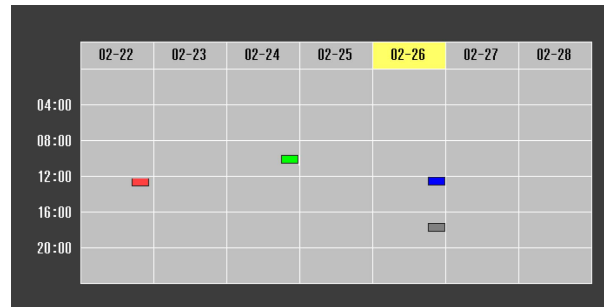

4. Press the left or right arrow buttons to highlight the date on the calendar containing the scheduled event you want to edit.
5. Press the up or down arrow buttons to highlight the event you want to edit, and press **Esc**.
6. Select one of the following:
  - **On/Off**: Enable or disable the selected event.
  - **Edit**: Edit the settings for the selected event.
  - **Clear**: Delete the selected event.
  - **Add New**: Add a new scheduled event.
7. When you are finished, select **Return** and press **Enter**.
8. Select **Setup complete** and select **Yes** to save your changes.

**Note:** To delete all scheduled events, select **Schedule Reset** and select **Yes**.

**Parent topic:** [Scheduling Projector Events](#)



---

# Adjusting the Menu Settings

Follow the instructions in these sections to access the projector menu system and change projector settings.

[Using the Projector's Menus](#)

[Image Quality Settings - Image Menu](#)

[Input Signal Settings - Signal Menu](#)

[Projector Feature Settings - Settings Menu](#)

[Projector Setup Settings - Extended Menu](#)

[Projector Network Settings - Network Menu](#)

[Projector Information Display - Info Menu](#)

[Projector Reset Options - Reset Menu](#)

## Using the Projector's Menus

You can use the projector's menus to adjust the settings that control how your projector works. The projector displays the menus on the screen.

1. Press the **Menu** button on the control panel or remote control.

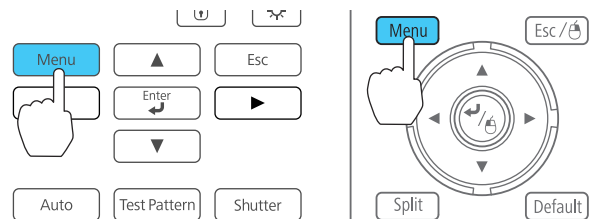

You see the menu screen displaying the Image menu settings.

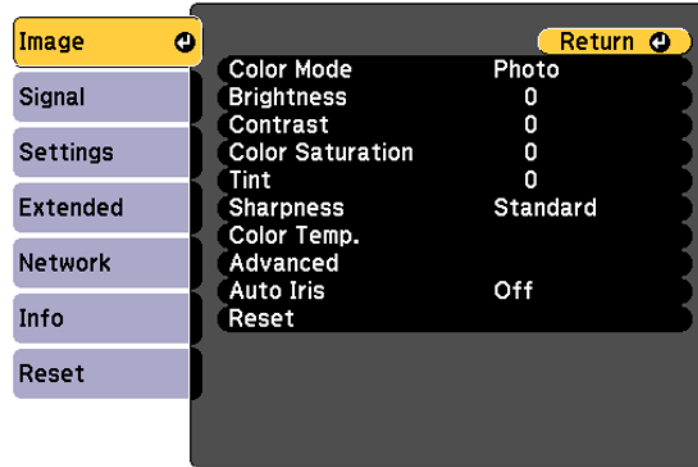

2. Press the up or down arrow button to move through the menus listed on the left. The settings for each menu are displayed on the right.

**Note:** The available settings depend on the current input source.

3. To change settings in the displayed menu, press **Enter**.
4. Press the up or down arrow button to move through the settings.
5. Change the settings using the buttons listed on the bottom of the menu screens.
6. To return all the menu settings to their default values, select **Reset**.
7. When you finish changing settings on a menu, press **Esc**.
8. Press **Menu** or **Esc** to exit the menus.

**Parent topic:** [Adjusting the Menu Settings](#)

## Image Quality Settings - Image Menu

Settings on the Image menu let you adjust the quality of your image for the input source you are currently using. The available settings depend on the currently selected input source.

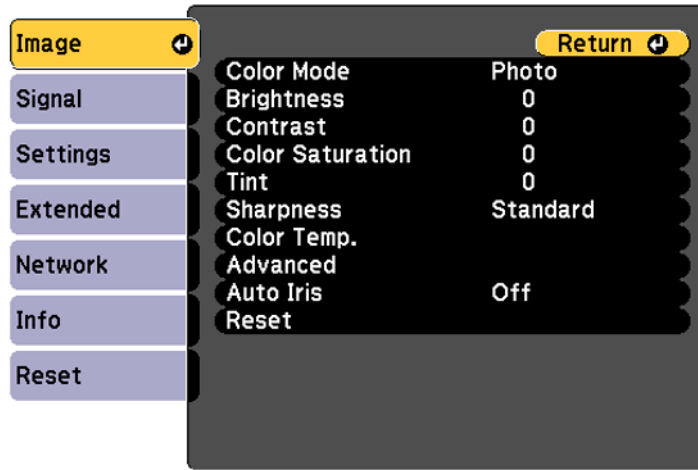

To change settings for an input source, make sure the source is connected and select that source.

Setting	Options	Description
<b>Color Mode</b>	See the list of available Color Modes	Adjusts the vividness of image colors for various image types and environments
<b>Brightness</b>	Varying levels available	Lightens or darkens the overall image
<b>Contrast</b>	Varying levels available	Adjusts the difference between light and dark areas of the image
<b>Color Saturation</b>	Varying levels available	Adjusts the intensity of the image colors
<b>Tint</b>	Varying levels available	Adjusts the balance of green to magenta tones in the image

Setting	Options	Description
<b>Sharpness</b>	Varying levels available	Adjusts the sharpness or softness of image details
<b>Color Temp.</b>	3200, 5000, or 10000 °K (Kelvin), or –3 to 6	Sets the color tone based on color temperature
<b>Advanced</b>	Various options available	Adjusts the gamma levels and intensity of individual hues in the image
<b>Auto Iris</b>	<b>Off</b> <b>Normal</b> <b>High Speed</b>	Adjusts the projected luminance based on the image brightness when certain Color Modes are selected

**Note:** The **Brightness** setting does not affect lamp brightness. To change the lamp brightness mode, use the **Power Consumption** setting.

**Parent topic:** [Adjusting the Menu Settings](#)

**Related references**

[Available Color Modes](#)

## Input Signal Settings - Signal Menu

Normally the projector detects and optimizes the input signal settings automatically. If you need to customize the settings, you can use the Signal menu. The available settings depend on the currently selected input source.

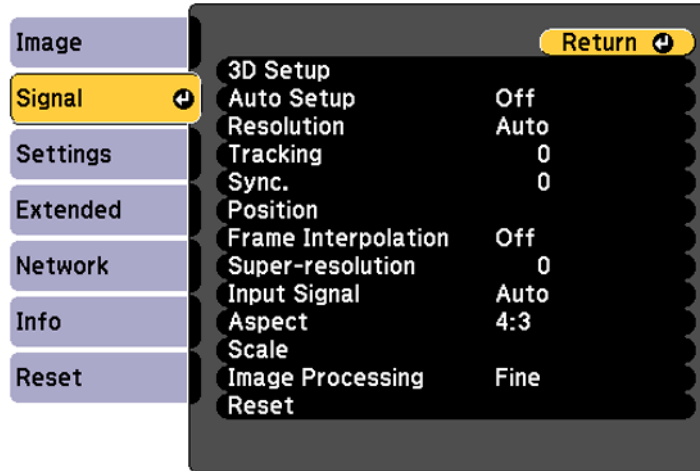

**Note:** You can restore the default settings of the **Position**, **Tracking**, and **Sync** settings by pressing the **Auto** button on the remote control.

To change settings for an input source, make sure the source is connected and select that source.

Setting	Options	Description
<b>3D Setup</b>	<b>On</b> <b>Off</b>	Enables passive 3D images when projecting from 2 projectors
<b>Auto Setup</b>	<b>On</b> <b>Off</b>	Automatically optimizes image quality from an analog RGB computer connection (when On)

Setting	Options	Description
<b>Resolution</b>	<b>Auto</b> <b>Normal</b> <b>Wide</b> <b>Manual</b>	Sets the input signal resolution from an analog RGB computer connection <b>Auto:</b> detects the resolution automatically <b>Normal:</b> for 4:3 or 5:4 screens <b>Wide:</b> for widescreen <b>Manual:</b> lets you specify a resolution
<b>Tracking</b>	Varying levels available	Adjusts signal to eliminate vertical stripes in images from an analog RGB computer connection
<b>Sync.</b>	Varying levels available	Adjusts signal to eliminate fuzziness or flickering in images from an analog RGB computer connection
<b>Position</b>	Up, down, left, right	Adjusts the image location on the screen
<b>Progressive</b>	<b>Off</b> <b>Video</b> <b>Film/Auto</b>	Sets whether to convert interlaced-to-progressive signals for certain video image types <b>Off:</b> for fast-moving video images <b>Video:</b> for most video images <b>Film/Auto:</b> for movies, computer graphics, and animation
<b>Frame Interpolation</b> (PowerLite Pro Z9750UNL/Z9870UNL/ Z10000UNL/Z10005UNL)	<b>Off</b> <b>Low</b> <b>Normal</b> <b>High</b>	Smooths fast moving video by comparing consecutive frames and inserting an intermediate frame between them

Setting	Options	Description
<b>Super-resolution</b>	Varying levels available	Reduces edge blurring that may occur when image is scaled up to fit the resolution of the image signal
<b>Noise Reduction</b>	<b>Off</b> <b>NR1</b> <b>NR2</b>	Reduces flickering in analog images in two levels
<b>Mosquito NR</b>	<b>On</b> <b>Off</b>	Reduces the noise or artifacts seen around the edges of objects that is caused by the decompression of MPEG video
<b>Video Range</b>	<b>Auto</b> <b>Normal</b> <b>Expanded</b>	Sets the video range to match the setting of the device connected to the <b>HDMI</b> , <b>HDBaseT</b> , and <b>SDI</b> (PowerLite Pro Z9870UNL/Z10000UNL/Z10005UNL) input ports
<b>Input Signal</b>	<b>Auto</b> <b>RGB</b> <b>Component</b>	Specifies the signal type from input sources connected to computer ports <b>Auto</b> : detects signals automatically <b>RGB</b> : corrects color for computer/RGB video inputs <b>Component</b> : corrects color for component video inputs
<b>Video Signal</b>	<b>Auto</b> Various video standards	Specifies the signal type from the input sources connected to the video ports <b>Auto</b> : detects signals automatically

Setting	Options	Description
<b>Aspect</b>	See the list of available aspect ratios	Sets the aspect ratio (width-to-height ratio) for the selected input source
<b>Scale</b>	Various scale options	When using multiple projectors to project one image, adjusts the scale of the image displayed by each projector
<b>Overscan</b>	<b>Auto</b> <b>Off</b> <b>4%</b> <b>8%</b>	Changes the projected image ratio to make the edges visible by a selectable percentage or automatically
<b>Image Processing</b>	<b>Fast</b> <b>Fine</b>	Adjusts how images are processed <b>Fast:</b> displays images quicker <b>Fine:</b> displays images in higher quality

Parent topic: [Adjusting the Menu Settings](#)

**Related references**

[Available Image Aspect Ratios](#)



## Projector Feature Settings - Settings Menu

Options on the Settings menu let you customize various projector features.

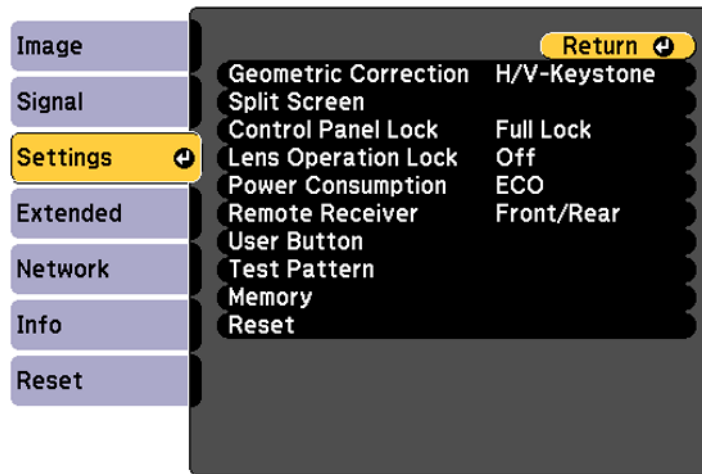

Setting	Options	Description
<b>Geometric Correction</b>	<b>Off</b> <b>H/V-Keystone</b> <b>Quick Corner</b> <b>Curved Surface</b> <b>Point Correction</b> <b>Corner Wall</b>	Adjusts the projected image shape  <b>H/V Keystone:</b> lets you manually correct the angles of the horizontal and vertical sides  <b>Quick Corner:</b> select to adjust the position of the four corners  <b>Curved Surface:</b> select to adjust the image when projecting on a curved surface  <b>Point Correction:</b> select to display a grid and finely adjust the image position  <b>Corner Wall:</b> select to adjust the image when projecting on a surface with a right angle
<b>Split Screen</b>	—	Divides the viewing area horizontally and displays two images side-by-side; while in Split Screen mode, press <b>Menu</b> to display the Split Screen options or <b>Esc</b> to cancel split screen display
<b>Control Panel Lock</b>	<b>Full Lock</b> <b>Partial Lock</b> <b>Off</b>	Controls projector button locking to secure the projector  <b>Full Lock:</b> locks all buttons  <b>Partial Lock:</b> locks all buttons except the power button  <b>Off:</b> no buttons locked
<b>Lens Operation Lock</b>	<b>On</b> <b>Off</b>	Locks the <b>Lens Shift</b> , <b>Zoom</b> , and <b>Focus</b> buttons on the remote control

Setting	Options	Description
<b>Power Consumption</b>	<b>Normal</b> <b>Temp Interlock</b> <b>ECO</b>	Selects the brightness mode of the projector lamp  <b>Normal:</b> sets maximum lamp brightness  <b>Temp Interlock:</b> automatically dims the lamp if the surrounding temperature is too high for normal operation  <b>ECO:</b> reduces lamp brightness and fan noise, and saves power and lamp life
<b>Remote Receiver</b>	<b>Front/Rear</b> <b>Front</b> <b>Rear</b> <b>Off</b>	Limits reception of remote control signals by the selected receiver; <b>Off</b> turns off all receivers
<b>User Button</b>	<b>User Button 1</b> <b>User Button 2</b> <b>User Button 3</b>	Assigns a menu option to the <b>User1</b> , <b>User2</b> , and <b>User3</b> buttons on the remote control for one-touch access
<b>Test Pattern</b>	—	Displays a test pattern to assist in adjusting the image; press the left or right arrow buttons on the remote control or <b>Enter</b> on the control panel to cycle through the available test patterns, or <b>Esc</b> to cancel pattern display
<b>Memory</b>	<b>Load Memory</b> <b>Save Memory</b> <b>Erase Memory</b> <b>Rename Memory</b>	Save customized sets of settings to memory

Parent topic: [Adjusting the Menu Settings](#)

## Projector Setup Settings - Extended Menu

Settings on the Extended menu let you customize various projector setup features that control its operation.

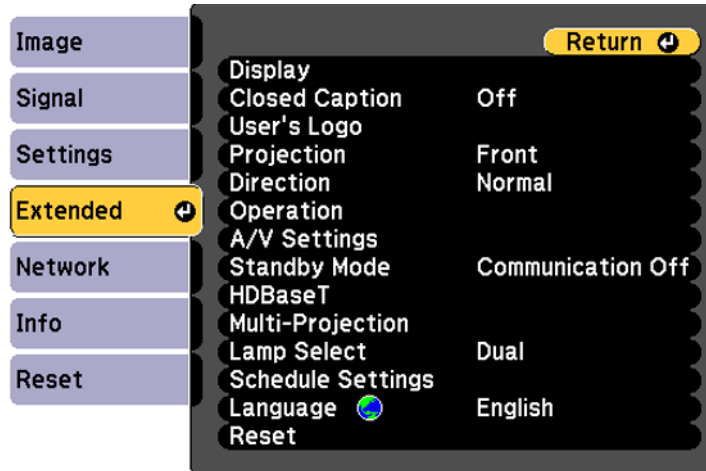

Setting	Options	Description
<b>Display</b>	—	See the Display settings table in this topic
<b>Closed Caption</b>	Off CC1 CC2	Controls use of closed captions and selects the closed caption type (closed captions are only visible for NTSC signals connected through the S-Video or Video ports)
<b>User's Logo</b>	—	Creates a screen that the projector displays to identify itself and enhance security

Setting	Options	Description
<b>Projection</b>	<b>Front</b> <b>Front/Upside Down</b> <b>Rear</b> <b>Rear/Upside Down</b>	Selects the way the projector faces the screen so the image is oriented correctly
<b>Direction</b>	Varying levels available	Selects the installation angle for the projector; the projector's fan may get louder depending on the direction angle selected
<b>Operation</b>	—	See the Operation settings table in this topic
<b>A/V Settings</b>	<b>A/V Output</b> <b>Monitor Out</b>	Selects various audio and video output settings  <b>A/V Output:</b> select to output audio and video to an external device when the projector is in standby mode (Standby Mode must be set to <b>Communication On</b> to use this setting)  <b>Monitor Out:</b> select the image source to output to an external device when the projector is in standby mode; when set to <b>Auto</b> , an analog RGB signal from the <b>Computer</b> or <b>BNC</b> ports is output depending on which source was selected when the projector went into standby mode

Setting	Options	Description
<b>Standby Mode</b>	<b>Communication On</b> <b>Communication Off</b>	<p>Enable this setting to allow the following operations to occur when the projector is in standby mode:</p> <ul style="list-style-type: none"> <li>• Monitor and control the projector over a network</li> <li>• Output audio and video to an external device (A/V Output must be set to <b>Always On</b>)</li> <li>• Communication from the <b>HDBaseT</b> port</li> </ul>
<b>HDBaseT</b>	<b>Control Communications</b> <b>Extron XTP</b>	<p>Selects the communication settings when you connect the projector to an HDBaseT Transmitter or switcher</p> <p><b>Control Communications:</b> enables or disables communication from the Ethernet and serial ports on the HDBaseT transmitter; also disables the projector's <b>LAN</b>, <b>RS-232C</b>, and <b>Remote</b> ports</p> <p><b>Extron XTP:</b> set to <b>On</b> when you connect the Extron XTP transmitter or switcher to the HDBaseT port</p>
<b>Multi-Projection</b>	—	See the Multi-Projection settings table in this topic
<b>Lamp Select</b>	<b>Dual</b> <b>Single</b> <b>Lamp1</b> <b>Lamp 2</b>	Select the lamps to be turned on

Setting	Options	Description
<b>Schedule Settings</b>	—	Schedule specific operations to occur at a pre-scheduled time
<b>Language</b>	Various languages available	Selects the language for projector menu and message displays (not changed by <b>Reset</b> option)

#### Display settings

Setting	Options	Description
<b>Menu Position</b>	—	Selects the position of the projector menu displayed on the screen
<b>Message Position</b>	—	Selects the position of the message displayed on the screen
<b>Messages</b>	—	Controls whether messages are displayed on the screen
<b>Display Background</b>	—	Selects the screen color or logo to display when no signal is received
<b>Startup Screen</b>	—	Controls whether a special screen appears when the projector starts up
<b>Standby Confirmation</b>	—	Displays a confirmation message after pressing the <b>Standby</b> button on the remote control
<b>Air Filter Notice</b>	—	Displays a message when a clog in the air filter is detected
<b>Screen</b>	—	Sets the aspect ratio and position of the projected image according to the type of screen being used
<b>Panel Alignment</b>	—	Corrects color misalignment in the projected image

Setting	Options	Description
Color Uniformity	—	Adjusts the color tone balance

#### Operation settings

Setting	Options	Description
Direct Power On	—	Turns on the projector when you plug it in
Sleep Mode	—	Automatically places the projector in standby mode after an interval of inactivity
Sleep Mode Timer	—	Sets the time before the projector automatically turns off (Sleep Mode must be turned on)
Shutter Timer	—	Automatically turns off the projector after approximately 120 minutes of inactivity
High Altitude Mode	—	Regulates the projector's operating temperature at altitudes above 4921 feet (1500 m).
Startup Source Search	—	Automatically detects the image signal being input when the projector is turned on
Auto Power On	—	Automatically turns on the projector when signals are received from the <b>Computer</b> or <b>BNC</b> input ports, even when the projector is in Standby status (only available when <b>Standby Mode</b> is set to <b>Communication On</b> )
Advanced	—	See the Advanced Operation settings table in this topic

#### Multi-Projection settings



Setting	Options	Description
<b>Projector ID</b>	—	Sets the projector to a particular ID number which allows you to use a remote control to individually control projectors
<b>Scale</b>	—	Adjusts the size of the image
<b>Color Mode</b>	—	Adjusts image color
<b>Color Uniformity</b>	—	Adjusts the color tone balance for the whole screen
<b>Edge Blending</b>	—	Blends the border between multiple images to create a seamless screen
<b>Brightness Level</b>	—	Adjusts the brightness of the lamp
<b>Color Matching</b>	—	Corrects the difference between the tint and brightness of each projected image
<b>RGBCMY</b>	—	Adjusts the hue, saturation, and brightness for red, green, blue, cyan, magenta, and yellow color components
<b>Black Level</b>	—	Adjusts the differences in overlapping images

#### Advanced Operation settings

Setting	Options	Description
<b>BNC Sync Termination</b>	—	Sets the termination for the signal from the BNC port (normally should be off unless analog termination such as for switchers is necessary)

Setting	Options	Description
Remote Control Type	—	Select <b>Normal</b> to use the remote control that came with the projector or <b>Simple</b> to use a different Epson projector remote control (disables the remote control that came with the projector)
Shutter Button	—	Select <b>Shutter</b> to open or close the electric shutter or <b>Blank</b> to turn off the image temporarily when you press the <b>Shutter</b> button
Shutter Release	—	Select <b>Shutter</b> to release the shutter function by pressing the <b>Shutter</b> button, or <b>Any Button</b> to release the shutter function when any operation is performed on the projector
Beep	—	Controls the beep that sounds when the projector turns on or off
Indicators	—	Turn on or off the projector's indicators except for errors or warnings
Lens Type	—	Select the model number for the lens you have attached
Instant Off	—	Set to <b>Enabled</b> to send the projector into standby status after power off or <b>Disabled</b> to send the projector into standby status approximately 3 minutes after power off
Date & Time	—	Adjusts the projector's system time and date settings

Parent topic: [Adjusting the Menu Settings](#)

## Projector Network Settings - Network Menu

Settings on the Network menu let you view network information and set up the projector for monitoring and control over a network.

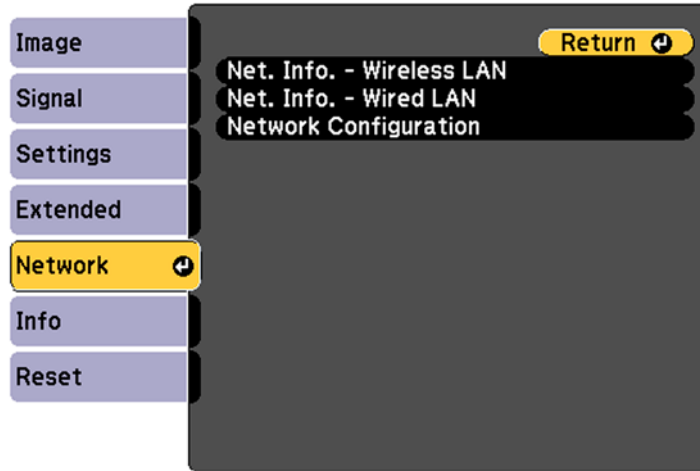

Setting	Options	Description
<b>Net. Info - Wireless LAN</b>	<b>Connection mode</b> <b>Wireless LAN System</b> <b>Antenna level</b> <b>Projector Name</b> <b>SSID</b> <b>DHCP</b> <b>IP Address</b> <b>Subnet Mask</b> <b>Gateway Address</b> <b>MAC Address</b> <b>Region Code</b>	Displays wireless network status and details

Setting	Options	Description
Net. Info - Wired LAN	<b>Projector Name</b> <b>DHCP</b> <b>IP Address</b> <b>Subnet Mask</b> <b>Gateway Address</b> <b>MAC Address</b>	Displays wired network status and details
Network Configuration	Accesses additional network menus	Configures your network settings

Parent topic: [Adjusting the Menu Settings](#)

**Related concepts**

[Wired Network Projection](#)

[Wireless Network Projection](#)

## Projector Information Display - Info Menu

You can display information about the projector and input sources by viewing the Info menu. However, you cannot change any settings in the menu.

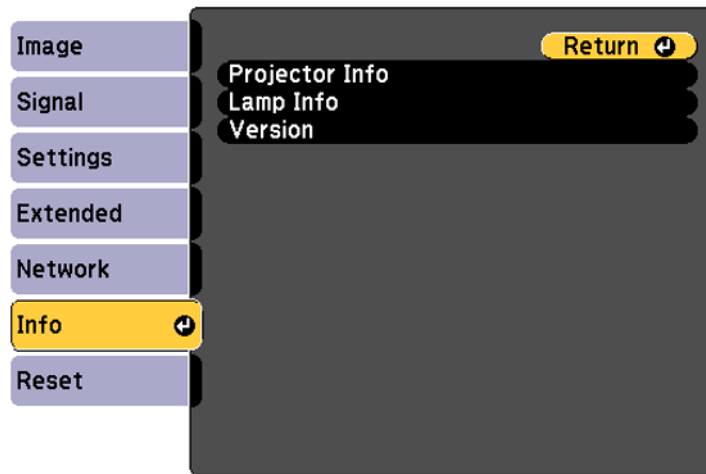

**Note:** The lamp usage timer does not register any hours until you have used the lamp for at least 10 hours. Available settings depend on the current input source.

Setting	Options	Description
<b>Projector Info</b>	—	See the next table in this topic
<b>Lamp Info</b>	<b>Lamp Hours</b> <b>Lamp Status</b>	Displays the following lamp information:  <b>Lamp Hours:</b> displays the number of hours ( <b>H</b> ) the lamp has been used in <b>Normal</b> and <b>ECO</b> Power Consumption modes; if the information is displayed in yellow, obtain a genuine Epson replacement lamp soon  <b>Lamp Status:</b> displays icons indicating the operating status of each lamp
<b>Version</b>	<b>Main</b> <b>Video</b> <b>Status Monitor</b>	Displays the projector's firmware information

#### Projector Info settings

Setting	Options	Description
<b>Source</b>	—	Displays the name of the current input source port
<b>Input Signal</b>	—	Displays the input signal setting of the current input source
<b>Resolution</b>	—	Displays the resolution of the current input source
<b>Video Signal</b>	—	Displays the video signal format of the current input source

Setting	Options	Description
Refresh Rate	—	Displays the refresh rate of the current input source
Sync Info	—	Displays information that may be needed by a service technician
Status	—	Displays information about projector problems that may be needed by a service technician
Serial Number	—	Displays the projector's serial number
Event ID	—	Displays the Event ID number corresponding to a specific projector problem; see the list of Event ID codes
HDBaseT Signal Quality	—	Displays the image signal information from the HDBaseT port

[Event ID Code List](#)

**Parent topic:** [Adjusting the Menu Settings](#)

**Related references**

[Optional Equipment and Replacement Parts](#)

[Projector Lamp Specifications](#)

## Event ID Code List

If the **Event ID** option on the Info menu displays a code number, check this list of Event ID codes for the solution to the projector problem associated with the code.

Event ID code	Cause and solution
0432	The EasyMP Network Projection program did not start. Turn the projector off and then on again.
0435	

Event ID code	Cause and solution
0434	Unstable network communication. Check the network communication status, wait a few moments, and try connecting to the network again.
0482	
0484	
0485	
0433	Cannot display the transferred images. Restart the EasyMP Network Projection program.
0481	Communication with computer was disconnected. Restart the EasyMP Network Projection program.
0483	The EasyMP Network Projection program quit unexpectedly. Check the network communication status, then turn the projector off and then on again.
04FE	
0479	A projector system error has occurred. Turn the projector off and then on again.
04FF	
0891	Cannot find an access point with the same SSID. Set your computer, access point, and projector to the same SSID.
0892	The WPA/WPA2 authentication type does not match. Make sure the wireless network security settings are correct.
0893	The TKIP/AES encryption type does not match. Make sure the wireless network security settings are correct.
0894	Communication with unauthorized access point was disconnected. Contact your network administrator.
0898	Failed to acquire DHCP. Make sure the DHCP server is operating correctly. If you are not using DHCP, turn off the <b>DHCP</b> setting in the Network menus.
0899	Communication error. Restart the EasyMP Network Projection program.

Parent topic: [Projector Information Display - Info Menu](#)

## Projector Reset Options - Reset Menu

You can reset most of the projector settings to their default values using the **Reset All** option on the Reset menu.

You can also reset the saved names and settings in the Save Memory list using the **Reset Memory** option.

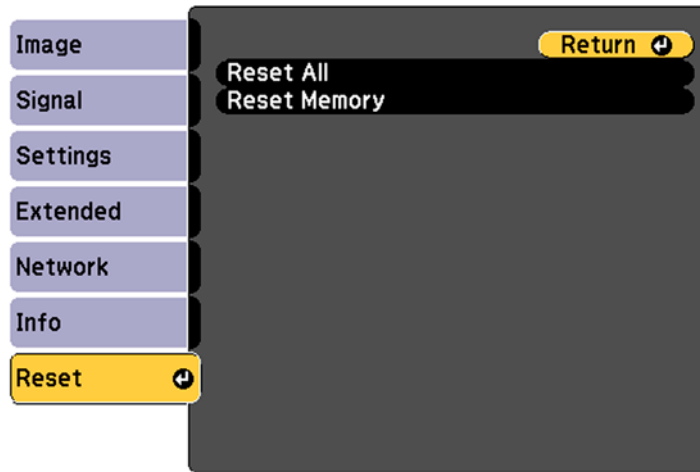

You cannot reset the following settings using the **Reset All** option:

- Input Signal
- User's Logo
- Language
- Network menu items
- Lamp Hours
- Date & Time
- Panel Alignment
- Color Uniformity
- Memory
- Color Matching
- Lamp Select

**Parent topic:** [Adjusting the Menu Settings](#)



---

# Maintaining and Transporting the Projector

Follow the instructions in these sections to maintain your projector and transport it from place to place.

[Projector Maintenance](#)

[Transporting the Projector](#)

## Projector Maintenance

Your projector needs little maintenance to keep working at its best.

You may need to clean the lens periodically, and clean the air filter and air vents to prevent the projector from overheating due to blocked ventilation.

The only parts you should replace are the lamp, air filter, and remote control batteries. If any other part needs replacing, contact Epson or an authorized Epson servicer.

**Warning:** Before cleaning any part of the projector, turn it off and unplug the power cord. Never open any cover on the projector, except as specifically explained in this manual. Dangerous electrical voltages in the projector can injure you severely.

**Warning:** Do not try to service this product yourself, except as specifically explained in this manual. Refer all other servicing to qualified servicers.

[Cleaning the Lens](#)

[Cleaning the Projector Case](#)

[Air Filter and Vent Maintenance](#)

[Projector Lamp Maintenance](#)

[Replacing the Remote Control Batteries](#)

**Parent topic:** [Maintaining and Transporting the Projector](#)

## Cleaning the Lens

Clean the projector's lens periodically, or whenever you notice dust or smudges on the surface.

- To remove dust or smudges, gently wipe the lens with lens-cleaning paper.

- To remove stubborn smudges, moisten a soft, lint-free cloth with lens cleaner and gently wipe the lens. Do not spray any liquid directly on the lens.

**Warning:** Do not use a lens cleaner that contains flammable gas. The high heat generated by the projector lamp may cause a fire.

**Caution:** Do not use glass cleaner or any harsh materials to clean the lens and do not subject the lens to any impacts; you may damage it. Do not use canned air, or the gases may leave a residue. Avoid touching the lens with your bare hands to prevent fingerprints on or damage to the lens surface.

**Parent topic:** [Projector Maintenance](#)

## Cleaning the Projector Case

Before cleaning the projector case, turn off the projector and unplug the power cord.

- To remove dust or dirt, use a soft, dry, lint-free cloth.
- To remove stubborn dirt, use a soft cloth moistened with water and mild soap. Do not spray liquid directly on the projector.

**Caution:** Do not use wax, alcohol, benzene, paint thinner, or other chemicals to clean the projector case. These can damage the case. Do not use canned air, or the gases may leave a residue.

**Parent topic:** [Projector Maintenance](#)

## Air Filter and Vent Maintenance

Regular filter maintenance is important to maintaining your projector. Your Epson projector is designed with an easily accessible, user-replaceable filter to protect your projector and make regular maintenance simple. Filter maintenance intervals will depend on the environment.

If regular maintenance is not performed, your Epson projector will notify you when the temperature inside the projector has reached a high level. Do not wait until this warning appears to maintain your projector filter as prolonged exposure to high temperatures may reduce the life of your projector or lamp.

Damage due to the failure to properly maintain the projector or its filter may not be covered by the projector or lamp Limited Warranties.

[Cleaning the Air Filter](#)

[Replacing the Air Filter](#)

**Parent topic:** [Projector Maintenance](#)

### Related concepts

[Projector Status Display](#)

### Related references

[Projector Light Status](#)

## Cleaning the Air Filter

You need to clean the projector's air filter in the following situations:

- The filter or vents get dusty.
  - You see a message telling you to clean it.
  - The projector's Filter light flashes orange.
1. Turn off the projector and unplug the power cord.
  2. Press and hold the tab on the air filter cover, and pull to remove the cover.

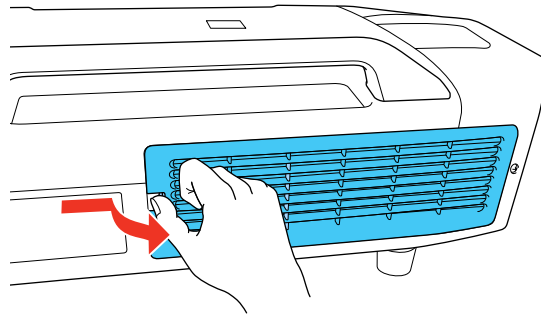

3. Pull the air filter out of the projector.

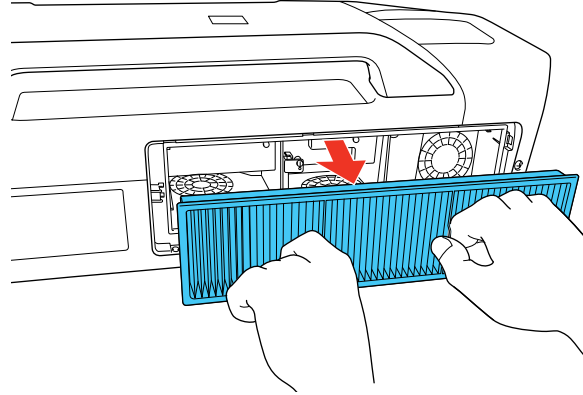

4. Tap each side of the air filter 4 to 5 times to shake off any excess dust.

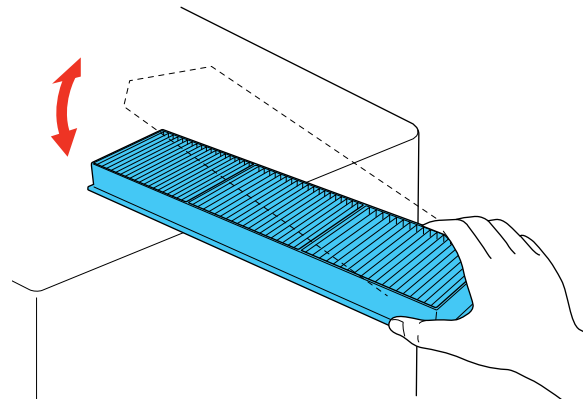

**Caution:** Do not use excessive force when tapping the air filter, or it may crack and become unusable. Do not rinse the air filter in water, or use any detergent or solvent to clean it. Do not use canned air; the gases may leave a residue, or push dust and debris into the projector's optics or other sensitive areas.

5. Vacuum the front of the air filter (the side with the tabs) to remove any remaining dust.

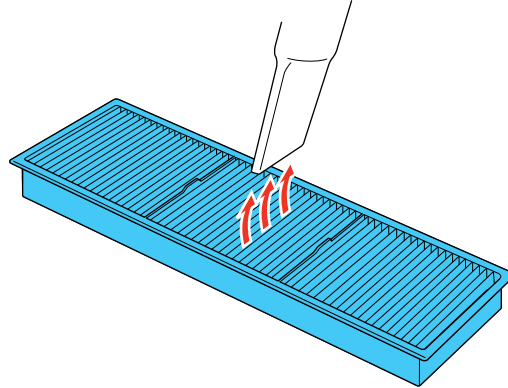

**Note:** If dust is difficult to remove or the air filter is damaged, replace the air filter.

6. Place the air filter back in the projector as shown.

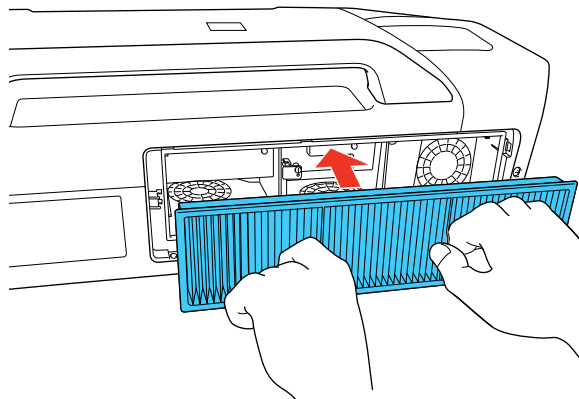

7. Attach the air filter cover as shown, and press it gently until it clicks into place.

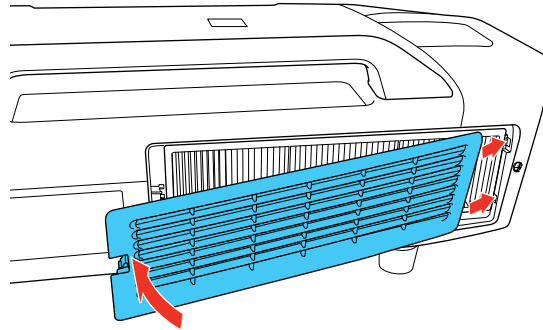

**Parent topic:** [Air Filter and Vent Maintenance](#)

**Related concepts**

[Projector Status Display](#)

**Related references**

[Projector Light Status](#)

### **Replacing the Air Filter**

You need to replace the air filter in the following situations:

- After cleaning the air filter, you see a message telling you to clean or replace it
- The air filter is torn or damaged

You can replace the air filter while the projector is mounted to the ceiling or placed on a table.

1. Turn off the projector and unplug the power cord.

2. Press and hold the tab on the air filter cover, and pull to remove the cover.

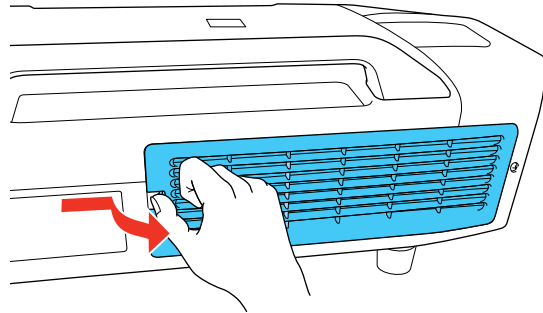

3. Pull the air filter out of the projector.

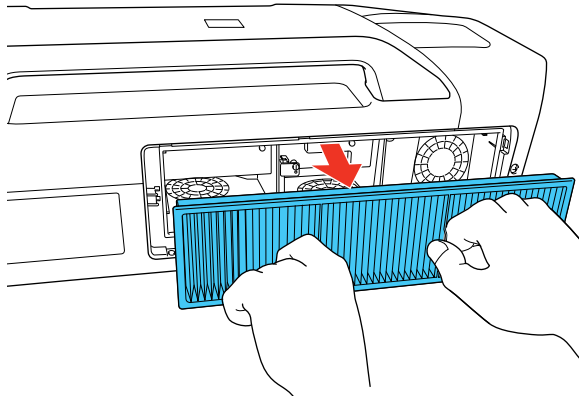

**Note:** Air filters contain polypropylene. Dispose of used air filters according to local regulations.

4. Place the new air filter in the projector as shown.

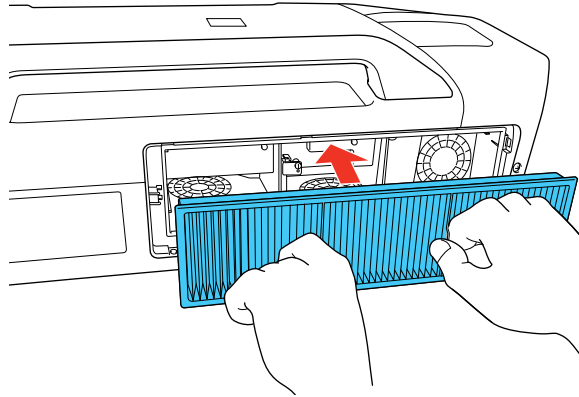

5. Attach the air filter cover as shown, and press it gently until it clicks into place.

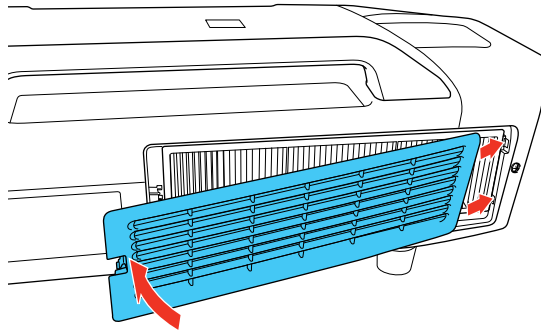

**Parent topic:** [Air Filter and Vent Maintenance](#)

**Related concepts**

[Projector Status Display](#)

**Related references**

[Projector Light Status](#)

[Optional Equipment and Replacement Parts](#)



## Projector Lamp Maintenance

The projector keeps track of the number of hours the lamp is used and displays this information in the projector's menu system.

Replace the lamp as soon as possible when the following occurs:

- The projected image gets darker or starts to deteriorate
- A message appears when you turn on the projector telling you to replace the lamp
- The power light is flashing blue and the Lamp 1 or Lamp 2 light is flashing orange.

[Replacing the Lamp](#)

[Resetting the Lamp Timer](#)

**Parent topic:** [Projector Maintenance](#)

### Related concepts

[Projector Status Display](#)

### Related references

[Optional Equipment and Replacement Parts](#)

[Projector Lamp Specifications](#)

[Projector Information Display - Info Menu](#)

[Projector Light Status](#)

## Replacing the Lamp

Before you replace the lamp, let the projector cool down for at least one hour so the lamp will not be hot.

**Warning:** Let the lamp fully cool before replacing it to avoid injury.

You can replace the lamp while the projector is mounted to the ceiling, if necessary.

1. Turn off the projector and unplug the power cord.
2. Allow the projector lamp to cool down for at least one hour.

- Slide the lamp cover latch to the **Open** position and slide the lamp cover to the left.

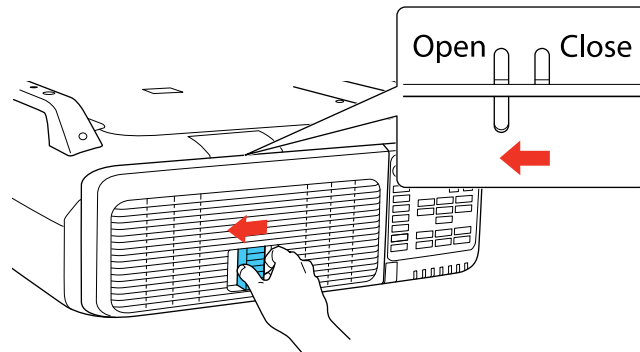

- Open the lamp cover.

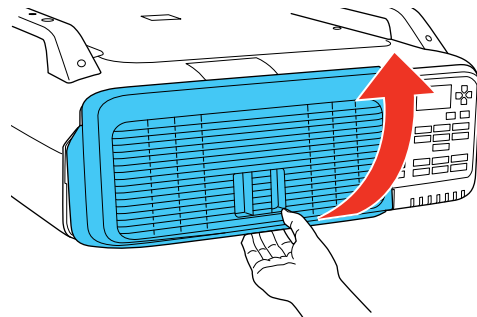

5. Pull up the lock lever for the lamp you want to replace and pull the lamp straight out of the projector.

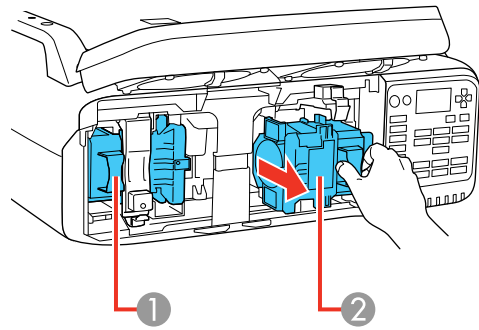
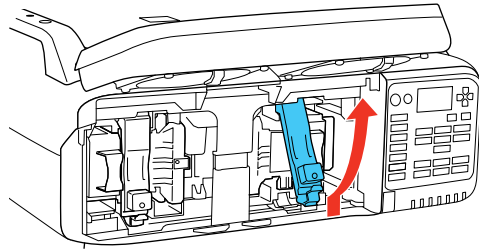

- 1 Lamp 1
- 2 Lamp 2

**Note:**  The lamp(s) in this product contain mercury. Please consult your state and local regulations regarding disposal or recycling. Do not put in the trash.

6. Gently insert the new lamp into the projector. If it does not fit easily, make sure it is facing the right way.

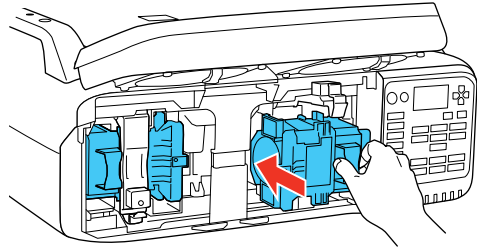

**Caution:** Do not touch any glass on the lamp assembly to avoid premature lamp failure.

7. Flip down the lock lever and press until it clicks into place.

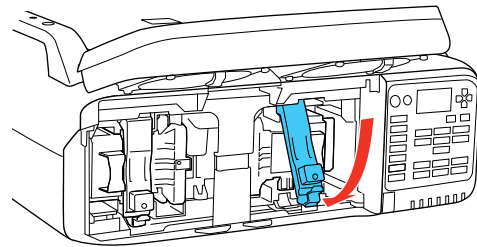

8. Close the lamp cover.

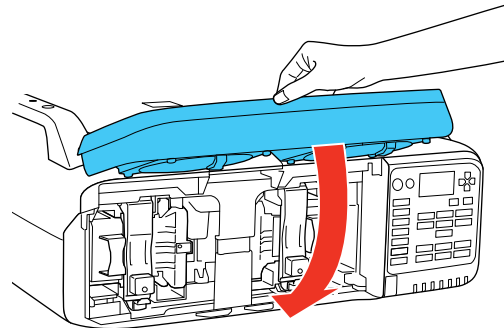

- Slide the lamp cover to the right until it clicks, and slide the lamp cover latch to the **Close** position.

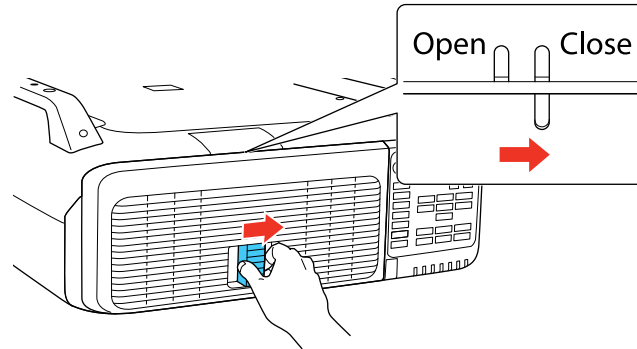

**Note:** Be sure the lamp cover is securely installed or the lamp will not come on.

Reset the lamp timer to zero to keep track of the new lamp's usage.

**Parent topic:** [Projector Lamp Maintenance](#)

**Related references**

[Optional Equipment and Replacement Parts](#)

**Related tasks**

[Resetting the Lamp Timer](#)

**Resetting the Lamp Timer**

You must reset the lamp timer after replacing the projector's lamp to clear the lamp replacement message and to keep track of lamp usage correctly.

**Note:** Do not reset the lamp timer if you have not replaced a lamp to avoid inaccurate lamp usage information.

- Turn on the projector.

- The following message is displayed on the screen:

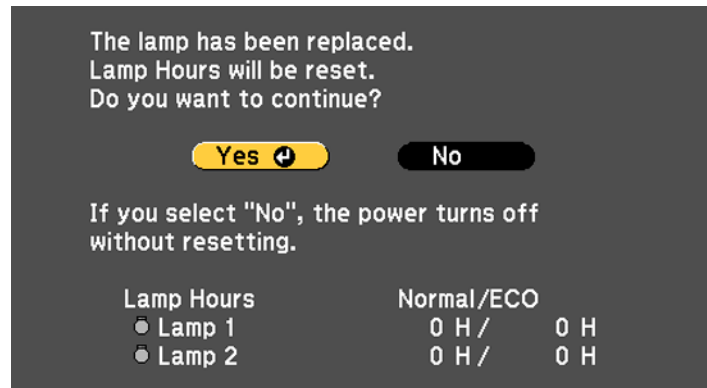

- Select **Yes** and press **Enter**.

The count for the lamp you replaced will return to 0 hours.

**Parent topic:** [Projector Lamp Maintenance](#)

**Related tasks**

[Replacing the Lamp](#)

## Replacing the Remote Control Batteries

The remote control uses two AA manganese or alkaline batteries. Replace the batteries as soon as they run out.

**Caution:** Use only the type of batteries specified in this manual. Do not install batteries of different types, or mix new and old batteries.

1. Open the battery cover as shown.

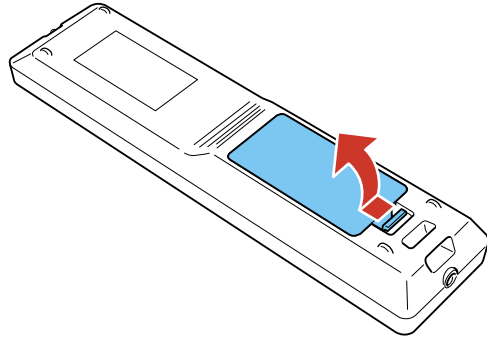

2. Remove the old batteries.

**Warning:** If the battery fluid has leaked, wipe it away with a soft cloth and avoid getting the fluid on your hands. If it gets on your hands, wash them immediately to avoid injury.

3. Insert the batteries with the + and – ends facing as shown.

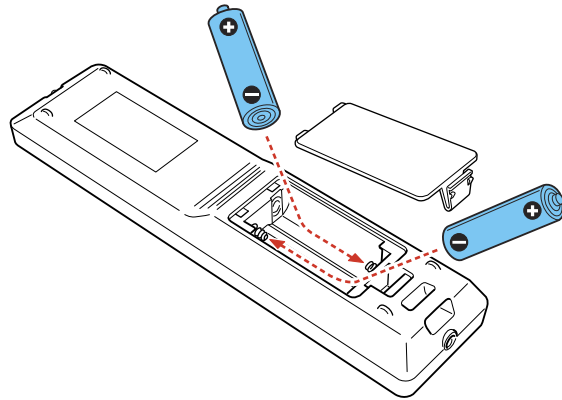

4. Close the battery cover and press it down until it clicks into place.

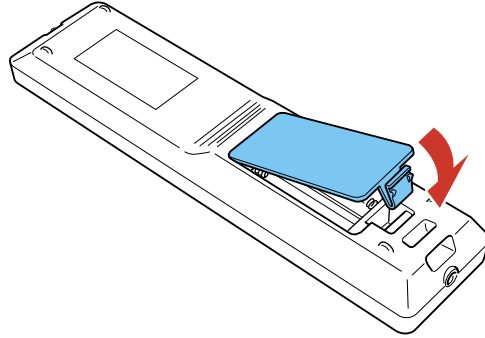

**Warning:** Dispose of used batteries according to local regulations. Do not expose batteries to heat or flame. Keep batteries out of the reach of children; they are choking hazards and are very dangerous if swallowed.

**Parent topic:** [Projector Maintenance](#)

**Related references**

[Remote Control Operation](#)

## Transporting the Projector

The projector contains precision parts, some of which are glass. Follow these guidelines to transport, ship, or store the projector safely:

- Remove any equipment connected to the projector.
- Do one of the following:
  - If you are using the standard zoom lens, keep it installed on the projector.
  - If you are using an optional lens, remove it from the projector.
  - If the projector did not come with a lens, attach the cover that was included with the projector to the lens mount.
- Center the lens using lens shift.
- Attach the protective lens pad that was included with the projector.
- When transporting the projector a long distance or as checked luggage, pack it in a firm box with cushioning around it and mark the box "Fragile."



- When shipping the projector for repairs, place it in its original packing materials, if possible, or use equivalent materials with cushioning around the projector. Mark the box "Fragile."

**Note:** Epson shall not be liable for any damages incurred during transportation.

**Parent topic:** [Maintaining and Transporting the Projector](#)

**Related tasks**

[Removing a Lens](#)

[Attaching a Lens](#)

[Adjusting the Image Position Using Lens Shift](#)

---

# Solving Problems

Check the solutions in these sections if you have any problems using the projector.

[Projection Problem Tips](#)

[Projector Light Status](#)

[Projector Status Display](#)

[Using the Projector Help Displays](#)

[Solving Image Problems](#)

[Solving Projector or Remote Control Operation Problems](#)

[Solutions When Network Alert E-Mails are Not Received](#)

[Where to Get Help](#)

## Projection Problem Tips

If the projector is not working properly, try turning it off and unplugging it. Then plug it back in and turn it on.

If this does not solve the problem, check the following:

- The lights on the projector may indicate what the problem is.
- The projector's Help system can display information about common problems, if the projector is operating.
- The solutions in this manual can help you solve many problems.

If none of these solutions help, you can contact Epson for technical support.

**Parent topic:** [Solving Problems](#)

## Projector Light Status

The lights on the projector's control panel indicate the projector status and let you know when a problem occurs. Check the status and color of the lights and look for a solution in the table here.

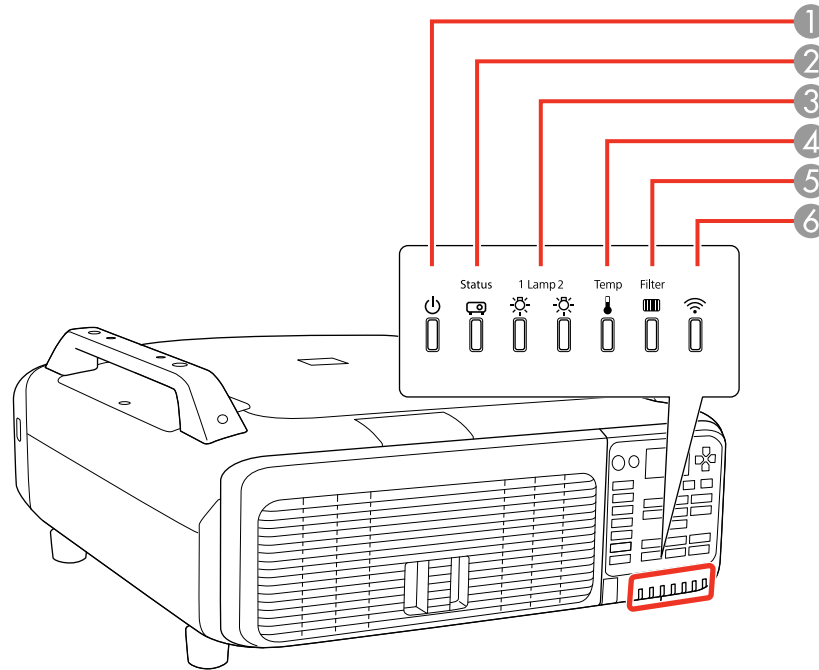

- 1 Power light
- 2 Status light
- 3 Lamp 1/Lamp 2 lights
- 4 Temp (temperature) light
- 5 Filter light
- 6 Wireless LAN light

Power light	Status light	Lamp lights	Temp light	Filter light	Status and solution
Blue	Blue	On	Off	Off	Normal operation.
Blue	Flashing blue	Off	Off	Off	Warming up. Wait for an image to appear.
Blue	Off	Off	Off	Off	Standby or sleep mode.
Flashing blue	Off	Off	Off	Off	Preparing network monitoring or shutting down. (Wait for the power light to remain blue before unplugging the projector.)
Blue	Blue	Flashing blue	Off	Off	The shutter function is on.
Blue	Flashing blue	Off	Off	Off	The projector has been turned off and is in cool down status.
Off	Flashing blue	Off	Orange	Off	<p>Projector is too hot.</p> <ul style="list-style-type: none"> <li>• Make sure that the vents and air filter are not clogged with dust or obstructed by nearby objects.</li> <li>• Clean or replace the air filter.</li> <li>• Make sure the environmental temperature is not too hot.</li> </ul>

Power light	Status light	Lamp lights	Temp light	Filter light	Status and solution
Off	Flashing blue	Off	Flashing orange	Off	<p>Fan or sensor error. Projector has overheated and turned off. Leave it turned off to cool down for five minutes.</p> <ul style="list-style-type: none"> <li>• Make sure that the vents and air filter are not clogged with dust or obstructed by nearby objects.</li> <li>• Clean or replace the air filter.</li> <li>• If operating the projector at high altitude, turn on <b>High Altitude Mode</b>.</li> <li>• If the problem persists, unplug the projector and contact Epson for help.</li> </ul>

Power light	Status light	Lamp lights	Temp light	Filter light	Status and solution
Off	Flashing blue	Orange	Off	Off	<p>The indicated lamp has a problem.</p> <ul style="list-style-type: none"> <li>• Check to see if a lamp is burned out, broken, or installed incorrectly. Reseat or replace the lamp as necessary.</li> <li>• Make sure that the vents and air filter are not clogged with dust or obstructed by nearby objects.</li> <li>• If operating the projector at high altitude, turn on <b>High Altitude Mode</b>.</li> <li>• Make sure that the <b>Direction</b> setting is correct.</li> <li>• If the problem persists, unplug the projector and contact Epson for help.</li> </ul>
Blue	Off	Off	Off	Flashing orange	Clean the air filter.

Power light	Status light	Lamp lights	Temp light	Filter light	Status and solution
Blue	Flashing blue	Off	Off	Flashing orange	<p>Low air flow through the projector or air filter.</p> <ul style="list-style-type: none"> <li>• Make sure that the vents and air filter are not clogged with dust or obstructed by nearby objects.</li> <li>• Clean or replace the air filter.</li> <li>• If the problem persists, unplug the projector and contact Epson for help.</li> </ul>
Flashing blue	Off	Off	Off	Orange	No air filter. Check to see if the air filter is securely installed.
Flashing blue	Off	Flashing orange	Off	Off	The indicated lamp is past its replacement period and must be replaced to avoid damage. Do not continue using the projector.
Blue	Off	Flashing orange	Off	Off	Lamp types are mismatched. Make sure two standard lamps or two portrait lamps are installed, depending on the orientation of the projector.
Off	Flashing blue	Off	Flashing orange	Off	A fan or sensor has a problem. Turn the projector off, unplug it, and contact Epson for help.

Power light	Status light	Lamp lights	Temp light	Filter light	Status and solution
Off	Flashing blue	Flashing orange	Off	Off	Internal projector error or air exhaust vent error. Turn the projector off, unplug it, and contact Epson for help.

**Note:** If the lights display a pattern not listed in the table above, turn the projector off, unplug it, and contact Epson for help.

**Parent topic:** [Solving Problems](#)

**Related references**

[Projector Setup Settings - Extended Menu](#)

[Projector Feature Settings - Settings Menu](#)

[Where to Get Help](#)

**Related tasks**

[Cleaning the Air Filter](#)

[Replacing the Air Filter](#)

[Replacing the Lamp](#)

## Projector Status Display

You can monitor the projector's status and view error information from the status display screen on the projector's control panel.

The status display menus list the following information:

- **Status Information:** The projector's operating status
- **Source:** Input signal information
- **Signal Information:** Input digital signal information
- **Network Wired:** Wired LAN settings
- **Network Wireless:** Wireless LAN settings
- **Maintenance:** Operating time for the projector and lamps



- **Version:** The projector's firmware version

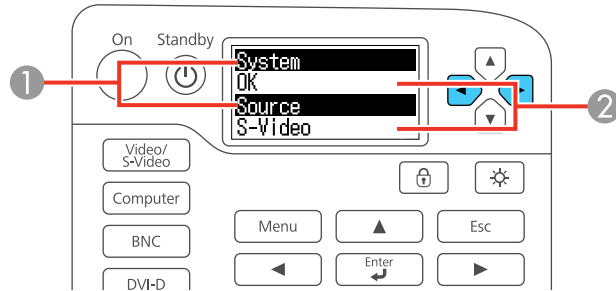

- 1 Status menu setting
- 2 Information about status setting

If a problem occurs, an error or warning message appears on the status screen. Press an arrow button to return the status screen to its normal state.

[Using the Projector Status Display](#)

[Adjusting the Projector Status Display](#)

[Projector Status Display Messages](#)

**Parent topic:** [Solving Problems](#)

#### **Related references**

[Projector Feature Settings - Settings Menu](#)

[Input Signal Settings - Signal Menu](#)

[Where to Get Help](#)

## **Using the Projector Status Display**

Follow these steps to use the projector status display.

1. Turn on the projector status display by pressing the light button on the control panel.

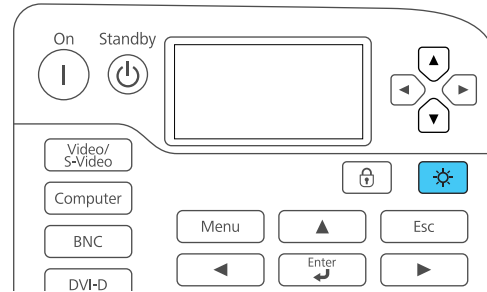

2. Press the left or right arrow button to view the display menus.
3. Press the up or down arrow to view the menu settings.

Parent topic: [Projector Status Display](#)

## Adjusting the Projector Status Display

You can adjust the contrast and the backlight duration on the status display screen.

1. Press the right or left arrow button to select the **Setting** menu.
2. Press the down arrow button to display the **Contrast**.
3. Press the left or right arrow button to adjust the contrast.
4. Press the down arrow button to display the **Lighting Time**.
5. Press the left or right arrow button to adjust the length of time the backlight stays on (default is 30 seconds).

Parent topic: [Projector Status Display](#)

## Projector Status Display Messages

Selections on the status display menus let you view information about the projector and its operation.

**Status Information** menu

Selection	Options	Description
<b>System</b>	—	See the System status information table at the end of this topic
<b>Source</b>	<b>Computer</b> <b>BNC</b> <b>Video</b> <b>S-Video</b> <b>HDMI</b> <b>DVI-D</b> <b>SDI</b> <b>LAN</b> <b>HDBaseT</b>	Displays the source currently being used
<b>On-Screen Display</b>	<b>On</b> <b>Off</b>	Displays the settings for the <b>On-Screen Display</b> . When set to <b>Off</b> , the menus or messages are not displayed on the projected images
<b>Shutter</b>	<b>Open</b> <b>Close</b>	Displays the projector's shutter function status
<b>Air Temp</b>	—	Displays the environmental temperature
<b>AC Voltage</b>	—	Displays the power voltage
<b>Lamp1 Type</b>	<b>Standard</b> <b>Portrait</b>	Display the lamp type for each lamp
<b>Lamp2 Type</b>	<b>Standard</b> <b>Portrait</b>	<b>Standard:</b> a standard lamp is installed <b>Portrait:</b> a portrait mode lamp is installed
<b>Lamp1 Status</b>	<b>On</b> <b>Off</b>	Displays the operating status of Lamp 1

Selection	Options	Description
Lamp2 Status	On Off	Displays the operating status of Lamp 2
Lamp Select	Dual Single Lamp1 Lamp2	Displays the lamp option currently selected <b>Dual</b> : both lamps are selected <b>Single</b> : a single lamp is selected <b>Lamp1</b> : only Lamp1 is selected <b>Lamp2</b> : only Lamp2 is selected

#### Source menu

Selection	Options	Description
Source	Computer BNC Video S-Video HDMI DVI-D SDI LAN HDBaseT	Displays the source currently being used
Resolution	—	Displays the resolution of the current input signal
Video Signal	—	Displays the current input video signal
Color Space	—	Displays the color space of the current input signal
H-Frequency	—	Displays the horizontal frequency of the current input signal

<b>Selection</b>	<b>Options</b>	<b>Description</b>
<b>V-Frequency</b>	—	Displays the vertical frequency of the current input signal
<b>Sync Polarity</b>	—	Displays the Sync polarity
<b>Sync Mode</b>	—	Displays the Sync type
<b>Detected Mode</b>	—	Displays the detected mode of the current input signal
<b>Video Level</b>	<b>Auto (Normal)</b> <b>Auto (Expanded)</b> <b>Normal</b> <b>Expanded</b>	Displays the video level of the projector

#### Signal Information menu

<b>Selection</b>	<b>Options</b>	<b>Description</b>
<b>5V Detect</b>	—	Displays the detection results of 5V signals
<b>TMDS Clock</b>	—	Displays the TMDS frequency of the current input signal
<b>TMDS H-Frequency</b>	—	Displays the horizontal frequency of the current input signal
<b>TMDS V-Frequency</b>	—	Displays the vertical frequency of the current input signal
<b>DetChg 5CFHMP123</b>	—	Displays the factors of signal changes
<b>Stable Time</b>	—	Displays the amount of operating time since the input source was determined
<b>HDCP Status</b>	<b>Non-HDCP</b> <b>Passed</b> <b>Failed</b>	Displays the HDCP status

Selection	Options	Description
HDCP Ri	—	Display information about each HDCP type
HDCP AKSV	—	
HDCP An	—	
AVI Info VIC	—	Displays the VIC information (AVI) of the current input signal
AVI InfoChecksum	OK NG	Displays the checksum result for AVI
Signal Mode	HDMI DVI	Displays the signal mode
Pixel Encoding	RGB YUV4:4:4 YUV4:2:2 YUV4:2:0	Displays the color space information (AVI) of the current input signal
HDBaseT Quality	—	Displays the image signal information from the HDBaseT port

#### Network Wired menu

Selection	Options	Description
Projector Name	—	Displays the name used to identify the projector when connected to a network
Connection Mode	HDBaseT LAN	Displays the connection path for the LAN
DHCP	—	Displays the DHCP display settings
IP Display	—	Displays the IP address display settings
IP Address	—	Displays the IP address

Selection	Options	Description
MAC Address	—	Displays the MAC address

#### Network Wireless menu

Selection	Options	Description
Projector Name	—	Displays the name used to identify the projector when connected to a network
Connection Mode	Quick Advanced	Displays the connection mode to use when connecting the projector and a computer over a wireless LAN
SSID Display	—	Displays the SSID display settings
IP Display	—	Displays the IP address display settings
SSID	—	Displays the SSID
IP Address	—	Displays the IP address
DHCP	—	Displays the DHCP settings
MAC Address	—	Displays the MAC address
Security	No WPA2-PSK WPA/WPA2-PSK	Displays the security settings
Antenna Level	Level 0-5	Displays the reception status for Wi-Fi

#### Maintenance menu

Selection	Description
Operation Time	Displays the projector's total operation time

Selection	Description
Lamp1 Op. Time	Displays the total operation time of standard Lamp 1
Lamp2 Op. Time	Displays the total operation time of standard Lamp 2
Lamp1 Op. Time PR	Displays the total operation time of portrait mode Lamp 1
Lamp2 Op. Time PR	Displays the total operation time of portrait mode Lamp 2

#### Version menu

Selection	Description
Serial No.	Displays the projector's serial number
Main	Displays the projector's firmware version information
Video	
Status Monitor	

#### Setting menu

Selection	Options	Description
Contrast	Level	Adjusts the contrast for the LCD screen
Lighting Time	Off 10 to 60 sec Approx. 30 min	Selects the duration of time for the status screen display

#### System status information

Status	Description
OK	The projector is in normal operating mode
Warm-up	The projector is warming up



Status	Description
Standby	The projector is in standby mode
Cool Down	The projector is cooling down
Temp Error	A high temperature error occurred
Fan Error	A fan error occurred
Sensor Error	A sensor error occurred
Lamp1 Error (S)	An error occurred in Lamp 1
Lamp1 Error (P)	<b>S:</b> indicates a standard lamp <b>P:</b> indicates a Portrait mode lamp
Lamp2 Error (S)	An error occurred in Lamp 2
Lamp2 Error (P)	<b>S:</b> indicates a standard lamp <b>P:</b> indicates a Portrait mode lamp
Lamp1 Failure (S)	A Lamp 1 failure occurred
Lamp1 Failure (P)	<b>S:</b> indicates a standard lamp <b>P:</b> indicates a Portrait mode lamp
Lamp2 Failure (S)	A Lamp 2 failure occurred
Lamp2 Failure (P)	<b>S:</b> indicates a standard lamp <b>P:</b> indicates a Portrait mode lamp
Power1 Error	A power error occurred
Power2 Error	
Internal Error	An internal error occurred
Cinema Filter Err	A cinema filter error occurred
Auto Iris Error	An auto iris error occurred
Airflow Error	A filter airflow error occurred
Shutter Error	A shutter error occurred
Pump Error	A system cooling error occurred
Temp Warning	A high temperature warning occurred

Status	Description
<b>Internal Warning</b>	A warning regarding the internal system occurred
<b>Airflow Decline</b>	A low airflow error occurred
<b>Lamp1 Warning (S)</b>	A lamp warning occurred in the indicated <b>Standard</b> or <b>Portrait</b> mode <b>Lamp 1</b> or <b>Lamp 2</b>
<b>Lamp1 Warning (P)</b>	
<b>Lamp2 Warning (S)</b>	
<b>Lamp2 Warning (P)</b>	
<b>Power1 Warning</b>	A power warning occurred
<b>Power2 Warning</b>	
<b>Shutter Warning</b>	A shutter warning occurred
<b>Direction Warning</b>	The usage angle is out of range. Check the lamp type and set it at the correct angle
<b>Lamp Mismatch</b>	A lamp type mismatch occurred; use the same type of lamp (Standard or Portrait mode) for both Lamp 1 and Lamp 2
<b>Clean Filter</b>	An air filter notice occurred; clean the air filter

**Parent topic:** [Projector Status Display](#)

**Related references**

[Projector Setup Settings - Extended Menu](#)

[Projector Feature Settings - Settings Menu](#)

[Input Signal Settings - Signal Menu](#)

[Optional Equipment and Replacement Parts](#)

[Projector Light Status](#)

## Using the Projector Help Displays

You can display information to help you solve common problems using the projector's Help system.

1. Turn on the projector.
2. Press the **Help** button on the remote control.

You see the Help menu.

3. Use the up and down arrow buttons to highlight the problem you want to solve.
4. Press **Enter** to view the solutions.
5. When you are finished, do one of the following:
  - To select another problem to solve, press **Esc**.
  - To exit the help system, press **Help**.

**Parent topic:** [Solving Problems](#)

## Solving Image Problems

Check the solutions in these sections if you have any problems with projected images.

[Solutions When No Image Appears](#)

[Solutions When "No Signal" Message Appears](#)

[Solutions When "Not Supported" Message Appears](#)

[Solutions When Only a Partial Image Appears](#)

[Solutions When the Image is Not Rectangular](#)

[Solutions When the Image Contains Noise or Static](#)

[Solutions When the Image is Fuzzy or Blurry](#)

[Solutions When the Image Brightness or Colors are Incorrect](#)

**Parent topic:** [Solving Problems](#)

### Solutions When No Image Appears

If no image appears, try the following solutions:

- Press the **Shutter** button on the remote control to see if the image was temporarily turned off.
- Make sure all necessary cables are securely connected and the power is on for the projector and connected video sources.
- Press the projector's power button to wake it from standby or sleep mode. Also see if your connected computer is in sleep mode or displaying a blank screen saver.
- Press the **Menu** button. If the projector menu is able to display, there may be a problem with the connected video source, cable connection, or port.
- Check the settings on the Signal menu to make sure they are correct for the current video source.
- Adjust the **Brightness** setting or select the **Normal** Power Consumption setting.
- Check the **Display** setting to make sure **Messages** is set to **On**.

- If the projector does not respond when you press the control panel buttons, the buttons may be locked. Unlock the buttons.
- If the projector does not respond when you press buttons on the remote control, make sure the remote receivers are turned on.
- For images projected with Windows Media Center, reduce the screen size from full screen mode.
- For images projected from applications using Windows DirectX, turn off DirectX functions.

**Parent topic:** [Solving Image Problems](#)

**Related concepts**

[Projector Connections](#)

**Related references**

[Projector Setup Settings - Extended Menu](#)

[Projector Feature Settings - Settings Menu](#)

[Input Signal Settings - Signal Menu](#)

[Image Quality Settings - Image Menu](#)

**Related tasks**

[Unlocking the Projector's Buttons](#)

## Solutions When "No Signal" Message Appears

If the "No Signal" message appears, try the following solutions:

- Press the **Search** button and wait a few seconds for an image to appear.
- Turn on the connected computer or video source, and press its play button to begin your presentation, if necessary.
- Check the connection from the projector to your video sources.
- If you are projecting from a laptop computer, make sure it is set up to display on an external monitor.
- If necessary, turn the projector and the connected computer or video source off and then on again.

[Displaying From a PC Laptop](#)

[Displaying From a Mac Laptop](#)

**Parent topic:** [Solving Image Problems](#)

**Related concepts**

[Projector Connections](#)

## Displaying From a PC Laptop

If you see the "No Signal" message when you display from a PC laptop, you need to set up the laptop to display on an external monitor.

1. Hold down the laptop's **Fn** key and press the key labelled with a monitor icon or **CRT/LCD**. (See your laptop manual for details.) Wait a few seconds for an image to appear.
2. To display on both the laptop's monitor and the projector, try pressing the same keys again.
3. If the same image is not displayed by the laptop and projector, check the Windows **Display** utility to make sure the external monitor port is enabled and extended desktop mode is disabled. (See your computer or Windows manual for instructions.)
4. If necessary, check your video card settings and set the multiple display option to **Mirror** or **Duplicate**.

**Parent topic:** [Solutions When "No Signal" Message Appears](#)

## Displaying From a Mac Laptop

If you see the "No Signal" message when you display from a Mac laptop, you need to set up the laptop for mirrored display. (See your laptop manual for details.)

1. Open the **System Preferences** utility and select **Displays**.
2. Click the **Arrangement** tab.
3. Select the **Mirror Displays** checkbox.

**Parent topic:** [Solutions When "No Signal" Message Appears](#)

## Solutions When "Not Supported" Message Appears

If the "Not Supported" message appears, try the following solutions:

- Make sure the correct input signal is selected on the Signal menu.
- Make sure the computer's display resolution does not exceed the projector's resolution and frequency limit. If necessary, select a different display resolution for your computer. (See your computer manual for details.)
- As a test, try setting the computer's display resolution to the lowest possible setting, and then gradually increase it as necessary.

**Parent topic:** [Solving Image Problems](#)

### Related references

[Input Signal Settings - Signal Menu](#)

[Supported Video Display Formats](#)

## Solutions When Only a Partial Image Appears

If only a partial computer image appears, try the following solutions:

- Press the **Auto** button on the remote control to optimize the image signal.
- Make sure you selected the correct **Screen Type** setting for the screen being used.
- Try adjusting the image position using the **Position** menu setting.
- Press the **Aspect** button on the remote control to select a different image aspect ratio.
- If you zoomed into or out of the image using the **E-Zoom** buttons, press the **Esc** button until the projector returns to a full display.
- Check your computer display settings to disable dual display and set the resolution within the projector's limits. (See your computer manual for details.)
- Check the resolution assigned to your presentation files to see if they are created for a different resolution than you are projecting in. (See your software help for details.)

**Parent topic:** [Solving Image Problems](#)

### Related references

[Input Signal Settings - Signal Menu](#)

[Projector Setup Settings - Extended Menu](#)

[Supported Video Display Formats](#)

### Related tasks

[Setting the Screen Type](#)

[Adjusting the Image Position Using Lens Shift](#)

## Solutions When the Image is Not Rectangular

If the projected image is not evenly rectangular, try the following solutions:

- Place the projector directly in front of the center of the screen, facing it squarely, if possible.
- Adjust the image shape using the **Geometric Correction** menu settings.

**Parent topic:** [Solving Image Problems](#)

### Related concepts

[Image Shape](#)

### Related references

[Projector Feature Settings - Settings Menu](#)

## Solutions When the Image Contains Noise or Static

If the projected image seems to contain electronic interference (noise) or static, try the following solutions:

- Check the cables connecting your computer or video source to the projector. They should be:
  - Separated from the power cord to prevent interference
  - Securely connected at both ends
  - Not connected to an extension cable
  - No longer than 10 feet (3 m) for VGA/computer cables or 24 feet (7.3 m) for HDMI cables
- Check the settings on the projector's Signal menu to make sure they match the video source. If available for your video source, adjust the **Progressive** and **Noise Reduction** settings.
- Select a computer video resolution and refresh rate that are compatible with the projector.
- If you are projecting from a computer, press the **Auto** button on the remote control to automatically adjust the tracking and sync. If the problem remains, display a uniformly patterned image on the screen and manually adjust the **Tracking** and **Sync** settings.
- If you adjusted the image shape using the projector controls, try decreasing the **Sharpness** setting to improve image quality.
- If you connected an extension power cable, try projecting without it to see if it caused interference in the signal.

**Parent topic:** [Solving Image Problems](#)

### Related references

[Input Signal Settings - Signal Menu](#)

[Supported Video Display Formats](#)

### Related tasks

[Displaying From a PC Laptop](#)

[Displaying From a Mac Laptop](#)

## Solutions When the Image is Fuzzy or Blurry

If the projected image is fuzzy or blurry, try the following solutions:

- Adjust the image focus.
- Clean the projector lens.

**Note:** To avoid condensation on the lens after bringing the projector in from a cold environment, let the projector warm up to room temperature before using it.

- Position the projector close enough to the screen, and directly in front of it.
- Position the projector so the keystone adjustment angle is not so wide that it distorts the image.
- Adjust the **Sharpness** setting to improve image quality.
- If you are projecting from a computer, press the **Auto** button on the remote control to automatically adjust the tracking and sync. If any bands or overall blurriness remain, display a uniformly patterned image on the screen and manually adjust the **Tracking** and **Sync** settings.
- Set the **Lens Type** setting to the correct lens in the Extended menu.
- If you are projecting from a computer, use a lower resolution.
- Turn off any keystone correction and disable the **Quick Corner** setting.

**Parent topic:** [Solving Image Problems](#)

#### **Related references**

[Input Signal Settings - Signal Menu](#)

[Image Quality Settings - Image Menu](#)

[Projection Distance](#)

#### **Related tasks**

[Focusing the Image Using the Focus Button](#)

[Cleaning the Lens](#)

## **Solutions When the Image Brightness or Colors are Incorrect**

If the projected image is too dark or light, or the colors are incorrect, try the following solutions:

- Press the **Color Mode** button on the remote control to try different color modes for the image and environment.
- Check your video source settings.
- Adjust the available settings on the Image menu for the current input source, such as **Brightness**, **Contrast**, **Tint**, **Advanced**, and **Color Saturation**.
- Make sure you selected the correct **Input Signal** or **Video Signal** setting on the Signal menu, if available for your image source.
- Make sure all the cables are securely connected to the projector and your video device. If you connected long cables, try connecting shorter cables.



- If you are using the **ECO** Power Consumption setting, try selecting **Normal** in the projector's menus.
- If only one lamp is in use, switch to **Dual** lamp mode.
- Position the projector close enough to the screen.
- If the image has been progressively darkening, you may need to replace a projector lamp soon.

**Parent topic:** [Solving Image Problems](#)

#### **Related concepts**

[Projector Lamp Maintenance](#)

#### **Related references**

[Input Signal Settings - Signal Menu](#)

[Image Quality Settings - Image Menu](#)

[Projector Feature Settings - Settings Menu](#)

## **Solving Projector or Remote Control Operation Problems**

Check the solutions in these sections if you have problems operating the projector or remote control.

[Solutions to Projector Power or Shut-Off Problems](#)

[Solutions to Problems with the Remote Control](#)

[Solutions to Password Problems](#)

**Parent topic:** [Solving Problems](#)

## **Solutions to Projector Power or Shut-Off Problems**

If the projector does not come on when you press the power button or it shuts off unexpectedly, try the following solutions:

- Make sure the power cord is securely connected to the projector and to a working electrical outlet.
- The projector's buttons may be locked for security. Unlock the buttons or use the remote control to turn on the projector.
- If the projector's lamps shut off unexpectedly, it may have entered standby mode after a period of inactivity. Press the power button to wake the projector and adjust the Sleep Mode Timer setting to change the sleep interval.
- If the projector's lamps shut off, the Status light is flashing blue, and the Temp light is orange, the projector has overheated and shut off. Check the solutions for this light status.
- Make sure the lamps and lamp cover are installed securely.

- If the power button on the remote control does not turn on the projector, check its batteries and make sure the **Remote Receiver** setting is turned on in the projector's menu, if available.
- Check to see if the projector is being controlled remotely through an RS-232 or LAN connection or a scheduled setting.
- Make sure the **ID** switch on the remote control is set to **Off**.
- The power cord may be defective. Disconnect the cord and contact Epson.

**Parent topic:** [Solving Projector or Remote Control Operation Problems](#)

#### **Related references**

[Projector Feature Settings - Settings Menu](#)

[Projector Light Status](#)

#### **Related tasks**

[Unlocking the Projector's Buttons](#)

## **Solutions to Problems with the Remote Control**

If the projector does not respond to remote control commands, try the following solutions:

- Check that the remote control batteries are installed correctly and have power. If necessary, replace the batteries.
- Make sure you are operating the remote control within the reception angle and range of the projector.
- Make sure the projector is not warming up or shutting down.
- Check to see if a button on the remote control is stuck down, causing it to enter sleep mode. Release the button to wake the remote control up.
- Strong fluorescent lighting, direct sunlight, or infrared device signals may be interfering with the projector's remote receivers. Dim the lights or move the projector away from the sun or interfering equipment.
- Make sure the optional remote control cable set is not attached to the projector's **Remote** port. If you leave the cable connected to the port, the remote control cannot control the projector.
- If available, turn off one of the remote receivers in the projector's menu system, or check if all the remote receivers were turned off.
- If you assigned an ID number to the remote control to operate multiple projectors, you may need to check or change the ID setting (feature not available with all projectors).
- Make sure the **Remote Control Type** setting in the Extended menu is set to **Normal** if you are using the remote control that came with the projector.

- Make sure the **Control Communications** setting in the Extended menu is set to **On** if you are not using the optional remote control cable set.
- If you lose the remote control, you can purchase another from an authorized Epson reseller.

**Parent topic:** [Solving Projector or Remote Control Operation Problems](#)

#### **Related references**

[Projector Feature Settings - Settings Menu](#)

[Optional Equipment and Replacement Parts](#)

[Remote Control Operation](#)

## **Solutions to Password Problems**

If you cannot enter or remember a password, try the following solutions:

- You may have turned on password protection without first setting a password. Try entering **0000** using the remote control.
- If you have entered an incorrect password too many times and see a message displaying a request code, write down the code and contact Epson. Do not attempt to enter the password again. Provide the request code and proof of ownership for assistance in unlocking the projector.
- If you set a Web Control password and forgot the user ID or password, try entering the following:
  - User ID: **EPSONWEB**
  - Default password: **admin**
- If you lose the remote control, you cannot enter a password. Order a new one from Epson.

**Parent topic:** [Solving Projector or Remote Control Operation Problems](#)

## **Solutions When Network Alert E-Mails are Not Received**

If you do not receive an e-mail alerting you to problems with a projector over the network, try the following solutions:

- Make sure the projector is turned on and connected to the network correctly. (If an error shut down the projector, it cannot send an e-mail.)
- Make sure you set up the projector e-mail alert settings correctly on the projector's network Mail menu or in the network software.
- Set the **Standby Mode** setting to **Communication On** so the network software can monitor the projector in standby mode.

**Parent topic:** [Solving Problems](#)

**Related concepts**

[Wired Network Projection](#)

[Wireless Network Projection](#)

**Related references**

[Projector Setup Settings - Extended Menu](#)

[Projector Network Settings - Network Menu](#)

## Where to Get Help

If you need to contact Epson for technical support services, use the following support options.

**Internet Support**

Visit Epson's support website at [epson.com/support](http://epson.com/support) (U.S.) or [epson.ca/support](http://epson.ca/support) (Canada) for solutions to common problems with your projector. You can download utilities and documentation, get FAQs and troubleshooting advice, or e-mail Epson with your questions.

**Speak to a Support Representative**

To use the Epson PrivateLine Support service, call (800) 637-7661. This service is available for the duration of your warranty period. You may also speak with a projector support specialist by dialing (562) 276-4394 (U.S.) or (905) 709-3839 (Canada).

Support hours are 6 AM to 8 PM, Pacific Time, Monday through Friday and 7 AM to 4 PM, Pacific Time, Saturday.

Days and hours of support are subject to change without notice. Toll or long distance charges may apply.

Before you call, have the following information ready:

- Product name
- Product serial number (located on the bottom or rear of the projector, or in the menu system)
- Proof of purchase (such as a store receipt) and date of purchase
- Computer or video configuration
- Description of the problem

**Purchase Supplies and Accessories**

You can purchase screens, other optional accessories, and replacement parts from an Epson authorized reseller. To find the nearest reseller, call 800-GO-EPSON (800-463-7766). Or you can purchase online at [epsonstore.com](http://epsonstore.com) (U.S. sales) or [epson.ca](http://epson.ca) (Canadian sales).

To purchase a replacement remote control, call (562) 276-4394 (U.S.) or (905) 709-3839 (for dealer referral in Canada).

**Parent topic:** [Solving Problems](#)

---

# Technical Specifications

These sections list the technical specifications of your projector.

[General Projector Specifications](#)

[Projector Lamp Specifications](#)

[Remote Control Specifications](#)

[Projector Dimension Specifications](#)

[Projector Electrical Specifications](#)

[Projector Environmental Specifications](#)

[Projector Safety and Approvals Specifications](#)

[Supported Video Display Formats](#)

## General Projector Specifications

<b>Type of display</b>	Poly-silicon TFT active matrix
<b>Resolution</b> (native)	1920 × 1200 pixels (WUXGA)
<b>Lens</b>	F=1.65 to 2.51 Focal length: 36 to 57.35 mm
<b>Color reproduction</b>	Full color, 1.07 billion colors

## Brightness

**Note:** Color brightness (color light output) and white brightness (white light output) will vary depending on usage conditions. Color light output measured in accordance with IDMS 15.4; white light output measured in accordance with ISO 21118.

### **PowerLite Pro Z9870NL:**

Normal Power Consumption mode:

White light output 8700 lumens (two lamps) or 4350 (one lamp) (ISO 21118 standard)

Color light output 8700 lumens (two lamps) or 4350 (one lamp)

ECO Power Consumption mode:

White light output 7300 lumens (two lamps) or 3650 (one lamp) (ISO 21118 standard)

Portrait lamps:

White light output 8500 lumens (two lamps) or 4250 (one lamp) (ISO 21118 standard)

Color light output 8500 lumens (two lamps) or 4250 (one lamp)

### **PowerLite Pro Z11005NL:**

Normal Power Consumption mode:

White light output 11000 lumens (two lamps) or 5500 (one lamp) (ISO 21118 standard)

Color light output 11000 lumens (two lamps) or 5500 (one lamp)

ECO Power Consumption mode:

White light output 7300 lumens (two lamps) or 3650 (one lamp) (ISO 21118 standard)

Portrait lamps:

White light output 8500 lumens (two lamps) or 4250 (one lamp) (ISO 21118 standard)

Color light output 8500 lumens (two lamps) or 4250 (one lamp)

**PowerLite Pro Z9800WNL:**

Normal Power Consumption mode:

White light output 8300 lumens (two lamps) or 4150 (one lamp) (ISO 21118 standard)

Color light output 8300 lumens (two lamps) or 4150 (one lamp)

ECO Power Consumption mode:

White light output 7100 lumens (two lamps) or 3550 (one lamp) (ISO 21118 standard)

Portrait lamps:

White light output 8100 lumens (two lamps) or 4050 (one lamp) (ISO 21118 standard)

Color light output 8100 lumens (two lamps) or 4050 (one lamp)

**PowerLite Pro Z9900WNL:**

Normal Power Consumption mode:

White light output 9200 lumens (two lamps) or 4600 (one lamp) (ISO 21118 standard)

Color light output 9200 lumens (two lamps) or 4600 (one lamp)

ECO Power Consumption mode:

White light output 7100 lumens (two lamps) or 3550 (one lamp) (ISO 21118 standard)

Portrait lamps:

White light output 8100 lumens (two lamps) or 4050 (one lamp) (ISO 21118 standard)

Color light output 8100 lumens (two lamps) or 4050 (one lamp)



**PowerLite Pro Z1100WNL:**

Normal Power Consumption mode:

White light output 11000 lumens (two lamps) or 5500 (one lamp) (ISO 21118 standard)

Color light output 11000 lumens (two lamps) or 5500 (one lamp)

ECO Power Consumption mode:

White light output 7100 lumens (two lamps) or 3550 (one lamp) (ISO 21118 standard)

Portrait lamps:

White light output 8100 lumens (two lamps) or 4050 (one lamp) (ISO 21118 standard)

Color light output 8100 lumens (two lamps) or 4050 (one lamp)

**PowerLite Pro Z9750UNL:**

Normal Power Consumption mode:

White light output 7500 lumens (two lamps) or 3750 (one lamp) (ISO 21118 standard)

Color light output 7500 lumens (two lamps) or 3750 (one lamp)

ECO Power Consumption mode:

White light output 6600 lumens (two lamps) or 3300 (one lamp) (ISO 21118 standard)

Portrait lamps:

White light output 7500 lumens (two lamps) or 3750 (one lamp) (ISO 21118 standard)

Color light output 7500 lumens (two lamps) or 3750 (one lamp)

**PowerLite Pro Z9870UNL:**

Normal Power Consumption mode:

White light output 8700 lumens (two lamps) or 4350 (one lamp) (ISO 21118 standard)

Color light output 8700 lumens (two lamps) or 4350 (one lamp)

ECO Power Consumption mode:

White light output 6600 lumens (two lamps) or 3300 (one lamp) (ISO 21118 standard)

Portrait lamps:

White light output 7500 lumens (two lamps) or 3750 (one lamp) (ISO 21118 standard)

Color light output 7500 lumens (two lamps) or 3750 (one lamp)

**PowerLite Pro Z10000UNL/Z10005UNL:**

Normal Power Consumption mode:

White light output 10000 lumens (two lamps) or 5000 (one lamp) (ISO 21118 standard)

Color light output 10000 lumens (two lamps) or 5000 (one lamp)

ECO Power Consumption mode:

White light output 6600 lumens (two lamps) or 3300 (one lamp) (ISO 21118 standard)

Portrait lamps:

White light output 7500 lumens (two lamps) or 3750 (one lamp) (ISO 21118 standard)

Color light output 7500 lumens (two lamps) or 3750 (one lamp)

Up to 15000:1 (with Auto Iris High Speed setting, Normal Power Consumption setting, standard lamps in dual-lamp mode, and lens shift settings at vertical  $\pm 60^\circ$  center and horizontal center)

**Contrast ratio**

**Image size**

(in native aspect ratio)

60 inches (1.52 m) to 500 inches (12.7 m)

<b>Projection distance</b> (in native aspect ratio)	78.3 inches (1.99 m) to 676 inches (17.17 m)
<b>Projection methods</b>	Front, rear, ceiling-mounted
<b>Optical aspect ratio</b> (width-to-height)	16:10
<b>Focus adjustment</b>	Powered, manual
<b>Zoom adjustment</b>	Powered, manual
<b>Zoom ratio</b> (Tele-to-Wide)	1 to 1.61 (standard lens)
<b>Noise level</b>	<p><b>PowerLite Pro Z9870NL/Z9800WNL/Z9750UNL:</b> 38 dB (Normal Power Consumption mode; standard lamps)</p> <p><b>PowerLite Pro Z9900WNL/Z9870UNL:</b> 39 dB (Normal Power Consumption mode; standard lamps)</p> <p><b>PowerLite Pro Z11005NL/Z11000WNL/Z10000UNL/Z10005UNL:</b> 40 dB (Normal Power Consumption mode; standard lamps) 35 dB all models (ECO Power Consumption mode; standard lamps)</p>
<b>Lens Shift Range</b>	<p>Vertical: <math>\pm 60^\circ</math> (horizontal center; powered)</p> <p>Horizontal: <math>\pm 18^\circ</math> (vertical center; powered)</p>

Parent topic: [Technical Specifications](#)

## Projector Lamp Specifications

<b>Type</b>	UHE (Ultra High Efficiency)
<b>Power consumption</b>	380 W per lamp (standard lamp) 304 W per lamp (portrait lamp)

<b>Lamp life</b> (standard lamps)	Normal Power Consumption mode: <b>PowerLite Pro Z9870NL/Z9800WNL/Z9750UNL:</b> Up to about 3000 hours (using two lamps) <b>PowerLite Pro Z9900WNL/Z9870UNL:</b> Up to about 2500 hours (using two lamps) <b>PowerLite Pro Z11005NL/Z11000WNL/Z10000UNL/Z10005UNL:</b> Up to about 2000 hours (using two lamps) ECO Power Consumption mode (all models): Up to about 4000 hours (using two lamps)
<b>Lamp life</b> (portrait lamps)	Up to about 1000 hours (using two lamps; all models)

**Note:** Turn off this product when not in use to prolong the life of the projector. Lamp life will vary depending upon mode selected, environmental conditions, and usage. Brightness decreases over time.

Parent topic: [Technical Specifications](#)

## Remote Control Specifications

<b>Reception range</b>	98.4 feet (30 m)
<b>Batteries</b>	Two alkaline or manganese AA

Parent topic: [Technical Specifications](#)

## Projector Dimension Specifications

<b>Height</b> (excluding feet, projection lens, and handles)	7.8 inches (197 mm)
<b>Width</b>	21 inches (534 mm)
<b>Depth</b>	29.2 inches (741 mm)

**Weight**

(including standard lens)

**PowerLite Pro Z9870NL/Z9800WNL/Z9750UNL:**

Approximately 56 lb (25 kg)

**PowerLite Pro Z11005NL/Z9900WNL/Z11000WNL/Z9870UNL/  
Z10000UNL/Z10005UNL:**

Approximately 58 lb (26 kg)

Parent topic: [Technical Specifications](#)

## Projector Electrical Specifications

**Rated frequency**

50/60 Hz

**Power supply**

100 to 240 VAC  $\pm$ 10%

**PowerLite Pro Z9870NL/Z9800WNL/Z9750UNL:**

8.5 to 3.8 A

**PowerLite Pro Z9900WNL/Z9870UNL:**

10.0 to 4.4 A

**PowerLite Pro Z11005NL/Z11000WNL/Z10000UNL/Z10005UNL:**

11.2 to 4.9 A

**Power consumption**

(100 to 120 V; using two standard lamps)

Operating:

**PowerLite Pro Z9870NL/Z9800WNL/Z9750UNL:**

Normal Power Consumption mode: 844 W

ECO Power Consumption mode: 748 W

**PowerLite Pro Z9900WNL/Z9870UNL:**

Normal Power Consumption mode: 995 W

ECO Power Consumption mode: 821 W

**PowerLite Pro Z11005NL/Z11000WNL/Z10000UNL/Z10005UNL:**

Normal Power Consumption mode: 1120 W

ECO Power Consumption mode: 821 W

Standby:

0.26 W (Communication Off), 2.7 W (Communication On)

**Power consumption**

(220 to 240 V; using two standard lamps)

Operating:

**PowerLite Pro Z9870NL/Z9800WNL/Z9750UNL:**

Normal Power Consumption mode: 809 W

ECO Power Consumption mode: 721 W

**PowerLite Pro Z9900WNL/Z9870UNL:**

Normal Power Consumption mode: 948 W

ECO Power Consumption mode: 788 W

**PowerLite Pro Z11005NL/Z11000WNL/Z10000UNL/Z10005UNL:**

Normal Power Consumption mode: 1060 W

ECO Power Consumption mode: 788 W

Standby:

0.37 W (Communication Off), 2.9 W (Communication On)

Parent topic: [Technical Specifications](#)

## Projector Environmental Specifications

<b>Temperature</b>	Operating: 32 to 122 °F (0 to 50 °C) up to 4921 feet (1500 m) altitude with Power Consumption set to <b>ECO</b> or <b>Temp Interlock</b> 32 to 113 °F (0 to 45 °C) up to 4921 feet (1500 m) altitude with Power Consumption set to <b>Normal</b> 32 to 113 °F (0 to 45 °C) from 4921 feet (1500 m) to 10000 feet (3048 m) altitude with Power Consumption set to <b>ECO</b> or <b>Temp Interlock</b> 32 to 104 °F (0 to 40 °C) from 4921 feet (1500 m) to 10000 feet (3048 m) altitude with Power Consumption set to <b>Normal</b> Storage: 14 to 140 °F (–10 to 60 °C)
<b>Humidity</b> (relative, non-condensing)	Operating: 20 to 80% Storage: 10 to 90%
<b>Operating altitude</b>	Up to 4921 feet (1500 m) Up to 10000 feet (3048 m) with High Altitude Mode enabled

Parent topic: [Technical Specifications](#)

## Projector Safety and Approvals Specifications

<b>United States</b>	FCC Part 15 Class B (DoC) UL60950-1 2nd edition (cTUVus Mark)
<b>Canada</b>	ICES-003 Class B CSA C22.2 No. 60950-1

Parent topic: [Technical Specifications](#)

## Supported Video Display Formats

For best results, your computer's monitor port or video card resolution should be set to display in the projector's native resolution. However, your projector includes Epson's SizeWise chip that supports other computer display resolutions, so your image will be resized to fit automatically.

Your computer's monitor port or video card refresh rate (vertical frequency) must be compatible with the projector. (See your computer or video card manual for details.)

The table here lists the compatible refresh rate and resolution for each compatible video display format.

Display format	Refresh rate (in Hz)	Resolution (in pixels)
<b>Computer signals (analog RGB)</b>		
VGA	60/72/75/85	640 × 480
SVGA	56/60/72/75/85	800 × 600
XGA	60/70/75/85	1024 × 768
WXGA	60	1280 × 768
	60	1366 × 768
	60/75/85	1280 × 800
WXGA+	60/75/85	1440 × 900
WXGA++	60	1600 × 900
SXGA	70/75/85	1152 × 864
	60/75/85	1280 × 960
	60/75/85	1280 × 1024
SXGA+	60/75	1400 × 1050
WSXGA <sup>+1</sup>	60	1680 × 1050
UXGA	60	1600 × 1200
WUXGA <sup>2</sup>	60	1920 × 1200
MAC13"	67	640 × 480
MAC16"	75	832 × 624
MAC19"	75	1024 × 768
	59	1024 × 768
MAC21"	75	1152 × 870
<b>Composite video</b>		
TV (NTSC)	60	720 × 480



Display format	Refresh rate (in Hz)	Resolution (in pixels)
TV (PAL)	50/60	720 × 576
TV (SECAM)	50	720 × 576
<b>Component video</b>		
SDTV (480i)	60	720 × 480
SDTV (576i)	50	720 × 576
SDTV (480p)	60	720 × 480
SDTV (576p)	50	720 × 576
HDTV (720p)	50/60	1280 × 720
HDTV (1080i)	50/60	1920 × 1080
HDTV (1080p) <sup>3</sup>	50/60	1920 × 1080
<b>DVI-D, HDMI, and HDBaseT (using optional HDBaseT Transmitter) input signals</b>		
VGA	60	640 × 480
SVGA	60	800 × 600
XGA	60	1024 × 768
WXGA	60	1280 × 800
	60	1280 × 768 <sup>4</sup>
	60	1366 × 768 <sup>5</sup>
WXGA+	60	1440 × 900
WXGA++	60	1600 × 900
WSXGA+ <sup>1</sup>	60	1680 × 1050
SXGA	60	1280 × 960
	60	1280 × 1024
SXGA+	60	1400 × 1050
UXGA	60	1600 × 1200
SDTV (480i/480p)	60	720 × 480
SDTV (576i/576p)	50	720 × 576

Display format	Refresh rate (in Hz)	Resolution (in pixels)
HDTV (720p)	50/60	1280 × 720
HDTV (1080i)	50/60	1920 × 1080
HDTV (1080p)	24/30/50/60	1920 × 1080
<b>SDI input signals<sup>5</sup></b>		
SDTV (480i)	60	720 × 480
SDTV (576i)	50	720 × 576
HDTV (720p)	50/60	1280 × 720
HDTV (1080i)	50i/60i	1920 × 1080
HDTV (1080p)	24p/25p/30p	1920 × 1080
3G-SDI (1080p)	50p/60p	1920 × 1080

<sup>1</sup> **Wide** resolution only (not available for PowerLite Pro Z9870NL and Z11005NL)

<sup>2</sup> Compatible only with VESA CVT-RB (Reduced Blanking) input signal (PowerLite Pro Z9750UNL/Z10000UNL/Z10005UNL only)

<sup>3</sup> Computer input port signals only

<sup>4</sup> PowerLite Pro Z9750UNL/Z10000UNL/Z10005UNL only

<sup>5</sup> PowerLite Pro Z9870UNL/Z10000UNL/Z10005UNL only

**Parent topic:** [Technical Specifications](#)

---

## Notices

Check these sections for important notices about your projector.

[Recycling](#)

[Important Safety Information](#)

[Important Safety Instructions](#)

[FCC Compliance Statement](#)

[Trademarks](#)

[Open Source Software License](#)

[Copyright Notice](#)

## Recycling

Epson offers a recycling program for end of life products. Please go to [this site](#) for information on how to return your products for proper disposal.

**Parent topic:** [Notices](#)

## Important Safety Information

**Caution:** Never look into the projector lens when the lamp is turned on; the bright light can damage your eyes. Never let children look into the lens when it is on. Never open any cover on the projector, except the lens, interface, and lamp and filter covers. Dangerous electrical voltages inside the projector can severely injure you. Except as specifically explained in this *User's Guide*, do not attempt to service this product yourself. Refer all servicing to qualified service personnel.

**Warning:** The projector and its accessories come packaged in plastic bags. Keep plastic bags away from small children to avoid any risk of suffocation.

**Caution:** When you replace the lamp, never touch the new lamp with your bare hands; the invisible residue left by the oil on your hands may shorten the lamp life. Use a cloth or glove to handle the new lamp.

**Parent topic:** [Notices](#)

## Important Safety Instructions

Follow these safety instructions when setting up and using the projector:

- Do not look into the lens when the projector is on. The bright light can damage your eyes. Avoid standing in front of the projector so the bright light does not shine into your eyes.
- Do not place the projector on an unstable cart, stand, or table.
- Do not operate the projector on its side, or while tilted to one side (unless using the optional portrait frame and lamps). Do not tilt the projector more than 100° forward or back.
- If the projector is mounted on a ceiling or wall, it should be installed by qualified technicians using mounting hardware designed for use with this projector.
- When installing or adjusting a ceiling or wall mount, do not use adhesives to prevent the screws from loosening and do not use oils or lubricants. This may cause the projector case to crack and the projector to fall from its ceiling mount. This could cause serious injury to anyone under the mount and could damage the projector.
- Do not use the projector near water, sources of heat, high-voltage electrical wires, or sources of magnetic fields.
- Use the type of power source indicated on the projector. Use of a different power source may result in fire or electric shock. If you are not sure of the power available, consult your dealer or power company.
- Place the projector near a wall outlet where the plug can be easily unplugged.
- Take the following precautions when handling the plug: Do not hold the plug with wet hands. Do not insert the plug into a dusty outlet. Insert the plug firmly into the outlet. Do not pull the power cord when disconnecting the plug; always be sure to hold the plug when disconnecting it. Do not overload wall outlets, extension cords, or power strips. Failure to comply with these precautions could result in fire or electric shock.
- Do not place the projector where the cord can be walked on. This may result in fraying or damage to the plug.
- Unplug the projector from the wall outlet and allow to cool before cleaning. Use a dry cloth (or, for stubborn dirt or stains, a moist cloth that has been wrung dry) for cleaning. Do not use liquid or aerosol cleaners, any sprays containing flammable gas, or solvents such as alcohol, paint thinner, or benzene.
- Do not block the slots and openings in the projector case. They provide ventilation and prevent the projector from overheating. Do not operate the projector on a sofa, rug, or other soft surface, or set it on top of loose papers. Do not cover the projector with a blanket, curtain, or tablecloth. If you are setting up the projector near a wall, leave at least 7.9 inches (20 cm) of space between the wall and the projector.
- Do not operate the projector in a closed-in cabinet unless proper ventilation is provided.

- Never allow objects of any kind to enter any openings in the projector. Do not leave objects, especially flammable objects, near the projector. Never spill liquid of any kind into the projector.
- If you are using two or more projectors side-by-side, leave at least 20 inches (50 cm) of space between the projectors to allow for proper ventilation.
- You may need to clean the air filter and vent. A clogged air filter or vent can block ventilation needed to cool the projector. Do not use canned air, or the gases may leave a residue.
- Do not store the projector outdoors for an extended length of time.
- Except as specifically explained in this manual, do not attempt to service this product yourself. Refer all servicing to qualified personnel. Opening or removing covers may expose you to dangerous voltages and other hazards.
- Never open any covers on the projector except as specifically explained in this manual. Never attempt to disassemble or modify the projector. Refer all repairs to qualified service personnel.
- Unplug the projector from the wall outlet and refer servicing to qualified service personnel under the following conditions: if it does not operate normally when you follow the operating instructions, or exhibits a distinct change in performance; if smoke, strange odors, or strange noises come from the projector; if the power cord or plug is damaged or frayed; if liquid or foreign objects get inside the projector, or if it has been exposed to rain or water; if it has been dropped or the housing has been damaged.
- Do not touch the plug during an electrical storm. Otherwise, you may receive an electric shock.
- Unplug the projector when it will not be used for extended periods.
- Do not use the projector where it may be exposed to rain, water, or excessive humidity.
- Do not use or store the projector where it may be exposed to smoke, steam, corrosive gases, excessive dust, vibration, or shock.
- Do not use the projector where flammable or explosive gases may be present.
- Do not use or store the projector or remote control in a hot location, such as near a heater, in direct sunlight, or in a closed vehicle.
- If you use the projector in a country other than where you purchased it, use the correct power cord for that country.
- Do not stand on the projector or place heavy objects on it.
- Do not use the projector outside of the required temperature range of 32 to 113 °F (0 to 45 °C) at an altitude of 4921 feet (1500 m) or less, or 32 to 104 °F (0 to 40 °C) at a higher altitude. Doing so may cause an unstable display and could lead to projector damage. Do not use or store the projector where it may be exposed to sudden changes in temperature.

- Do not store the projector outside of the required temperature range of 14 to 140 °F (–10 to 60 °C) or in direct sunlight for long periods of time. Doing so may cause damage to the case.
- Do not place anything that can become warped or damaged by heat near the exhaust vents. Do not bring your hands or face close to the vents while projection is in progress. Do not bring your face close to the projector while it is in use.
- Before you move the projector, make sure its power is turned off, the plug is disconnected from the outlet, and all cables are disconnected.
- Never try to remove the lamp immediately after use because it will be extremely hot. Before removing the lamp, turn off the power and wait at least an hour to allow the lamp to cool completely.
- Do not disassemble the lamp or subject it to impacts.
- Do not place the source of an open flame, such as a lit candle, on or near the projector.
- Do not block the lens during projection using a book or any other object. This could damage the projector or cause a fire.
- Do not modify the power cord. Do not place heavy objects on top of the power cord or bend, twist, or pull it excessively. Keep the power cord away from hot electrical appliances.
- If the lamp breaks, ventilate the room to prevent gases contained in the lamp from being inhaled or coming in contact with your eyes or mouth. If you do inhale gases or gases come in contact with your eyes or mouth, seek medical advice immediately.
- If the projector is mounted overhead and the lamp breaks, be careful to prevent pieces of glass from falling into your eyes or mouth when you open the lamp cover. If pieces of glass do get into your eyes or mouth, seek medical advice immediately.
- Always attach the lens unit cap to the lens when not using the projector to prevent the lens from becoming dirty or damaged.

**Note:**  The lamp(s) in this product contain mercury. Please consult your state and local regulations regarding disposal or recycling. Do not put in the trash.

**WARNING:** The cords included with this product contain chemicals, including lead, known to the State of California to cause birth defects or other reproductive harm. ***Wash hands after handling.*** (This notice is provided in accordance with Proposition 65 in Cal. Health & Safety Code § 25249.5 and following.)

[Restriction of Use](#)

**Parent topic:** [Notices](#)

## Restriction of Use

When this product is used for applications requiring high reliability/safety such as transportation devices related to aviation, rail, marine, automotive; disaster prevention devices; various safety devices; or functional/precision devices, you should use this product only after giving consideration to including fail-safes and redundancies into your design to maintain safety and total system reliability.

Because this product was not intended for use in applications requiring extremely high reliability/safety such as aerospace equipment, main communication equipment, nuclear power control equipment, or medical equipment related to direct medical care, please make your own judgment on this product's suitability after a full evaluation.

**Parent topic:** [Important Safety Instructions](#)

## FCC Compliance Statement

### For United States Users

This equipment has been tested and found to comply with the limits for a Class B digital device, pursuant to Part 15 of the FCC Rules. These limits are designed to provide reasonable protection against harmful interference in a residential installation. This equipment generates, uses, and can radiate radio frequency energy and, if not installed and used in accordance with the instructions, may cause harmful interference to radio communications. However, there is no guarantee that interference will not occur in a particular installation. If this equipment does cause interference to radio and television reception, which can be determined by turning the equipment off and on, the user is encouraged to try to correct the interference by one or more of the following measures:

- Reorient or relocate the receiving antenna.
- Increase the separation between the equipment and receiver.
- Connect the equipment into an outlet on a circuit different from that to which the receiver is connected.
- Consult the dealer or an experienced radio/TV technician for help.

### WARNING

The connection of a non-shielded equipment interface cable to this equipment will invalidate the FCC Certification or Declaration of this device and may cause interference levels which exceed the limits established by the FCC for this equipment. It is the responsibility of the user to obtain and use a shielded equipment interface cable with this device. If this equipment has more than one interface connector, do not leave cables connected to unused interfaces. Changes or modifications not expressly approved by the manufacturer could void the user's authority to operate the equipment.

## For Canadian Users

CAN ICES-3(B)/NMB-3(B)

Parent topic: [Notices](#)

## Trademarks

EPSON®, EasyMP®, Instant Off®, PowerLite®, and Quick Corner® are registered trademarks, and EPSON Exceed Your Vision is a registered logomark of Seiko Epson Corporation.

Accolade® and PrivateLine® are registered trademarks; Duet™ and SizeWise™ are trademarks; and Epson Store<sup>SM</sup> and Extra Care<sup>SM</sup> are service marks of Epson America, Inc.

Mac and OS X are trademarks of Apple Inc., registered in the U.S. and other countries.

HDMI and High-Definition Multimedia Interface are the trademarks or registered trademarks of HDMI Licensing LLC.  HIGH DEFINITION MULTIMEDIA INTERFACE

HDBaseT™ and the HDBaseT Alliance logo are trademarks of the HDBaseT Alliance.

Crestron® and Crestron RoomView® are registered trademarks of Crestron Electronics, Inc.

General Notice: Other product names used herein are for identification purposes only and may be trademarks of their respective owners. Epson disclaims any and all rights in those marks.



Parent topic: [Notices](#)

## Open Source Software License

GNU GPL

This projector product includes the open source software programs which apply the GNU General Public License Version 2 or later version ("GPL Programs").

We provide the source code of the GPL Programs until five (5) years after the discontinuation of same model of this projector product.

If you desire to receive the source code of the GPL Programs, contact Epson as described in the *User's Guide*.



These GPL Programs are WITHOUT ANY WARRANTY; without even the implied warranty of MERCHANTABILITY AND FITNESS FOR A PARTICULAR PURPOSE. See the GNU General Public License for more details.

The list of GPL Programs is as follows and the names of author are described in the source code of the GPL Programs

The list of GPL Programs

busybox-1.13.4

iptables-1.4.4

libgcc1(gcc-4.3.3)

libstdc++-6.0.10

linux-2.6.27

patches

udhcp 0.9.8

uvc rev.219

wireless\_tools 29

EPSON original drivers

The GNU General Public License Version 2 is as follows. You also can see the GNU General Public License Version 2 at <http://www.gnu.org/licenses/>.

GNU GENERAL PUBLIC LICENSE

Version 2, June 1991

Copyright ©) 1989, 1991 Free Software Foundation, Inc., 51 Franklin Street, Fifth Floor, Boston, MA 02110-1301 USA Everyone is permitted to copy and distribute verbatim copies of this license document, but changing it is not allowed.

Preamble

The licenses for most software are designed to take away your freedom to share and change it. By contrast, the GNU General Public License is intended to guarantee your freedom to share and change free software--to make sure the software is free for all its users. This General Public License applies to most of the Free Software Foundation's software and to any other program whose authors commit to using it. (Some other Free Software Foundation software is covered by the GNU Lesser General Public License instead.) You can apply it to your programs, too.

When we speak of free software, we are referring to freedom, not price. Our General Public Licenses are designed to make sure that you have the freedom to distribute copies of free software (and charge for

this service if you wish), that you receive source code or can get it if you want it, that you can change the software or use pieces of it in new free programs; and that you know you can do these things.

To protect your rights, we need to make restrictions that forbid anyone to deny you these rights or to ask you to surrender the rights. These restrictions translate to certain responsibilities for you if you distribute copies of the software, or if you modify it.

For example, if you distribute copies of such a program, whether gratis or for a fee, you must give the recipients all the rights that you have. You must make sure that they, too, receive or can get the source code. And you must show them these terms so they know their rights.

We protect your rights with two steps: (1) copyright the software, and (2) offer you this license which gives you legal permission to copy, distribute and/or modify the software.

Also, for each author's protection and ours, we want to make certain that everyone understands that there is no warranty for this free software. If the software is modified by someone else and passed on, we want its recipients to know that what they have is not the original, so that any problems introduced by others will not reflect on the original authors' reputations.

Finally, any free program is threatened constantly by software patents. We wish to avoid the danger that redistributors of a free program will individually obtain patent licenses, in effect making the program proprietary. To prevent this, we have made it clear that any patent must be licensed for everyone's free use or not licensed at all.

The precise terms and conditions for copying, distribution and modification follow.

## GNU GENERAL PUBLIC LICENSE TERMS AND CONDITIONS FOR COPYING, DISTRIBUTION AND MODIFICATION

0. This License applies to any program or other work which contains a notice placed by the copyright holder saying it may be distributed under the terms of this General Public License. The "Program", below, refers to any such program or work, and a "work based on the Program" means either the Program or any derivative work under copyright law: that is to say, a work containing the Program or a portion of it, either verbatim or with modifications and/or translated into another language. (Hereinafter, translation is included without limitation in the term "modification".) Each licensee is addressed as "you".

Activities other than copying, distribution and modification are not covered by this License; they are outside its scope. The act of running the Program is not restricted, and the output from the Program is covered only if its contents constitute a work based on the Program (independent of having been made by running the Program). Whether that is true depends on what the Program does.

1. You may copy and distribute verbatim copies of the Program's source code as you receive it, in any medium, provided that you conspicuously and appropriately publish on each copy an appropriate copyright notice and disclaimer of warranty; keep intact all the notices that refer to this License and to the absence of any warranty; and give any other recipients of the Program a copy of this License along with the Program.

You may charge a fee for the physical act of transferring a copy, and you may at your option offer warranty protection in exchange for a fee.

2. You may modify your copy or copies of the Program or any portion of it, thus forming a work based on the Program, and copy and distribute such modifications or work under the terms of Section 1 above, provided that you also meet all of these conditions:

- a) You must cause the modified files to carry prominent notices stating that you changed the files and the date of any change.
- b) You must cause any work that you distribute or publish, that in whole or in part contains or is derived from the Program or any part thereof, to be licensed as a whole at no charge to all third parties under the terms of this License.
- c) If the modified program normally reads commands interactively when run, you must cause it, when started running for such interactive use in the most ordinary way, to print or display an announcement including an appropriate copyright notice and a notice that there is no warranty (or else, saying that you provide a warranty) and that users may redistribute the program under these conditions, and telling the user how to view a copy of this License. (Exception: if the Program itself is interactive but does not normally print such an announcement, your work based on the Program is not required to print an announcement.)

These requirements apply to the modified work as a whole. If identifiable sections of that work are not derived from the Program, and can be reasonably considered independent and separate works in themselves, then this License, and its terms, do not apply to those sections when you distribute them as separate works. But when you distribute the same sections as part of a whole which is a work based on the Program, the distribution of the whole must be on the terms of this License, whose permissions for other licensees extend to the entire whole, and thus to each and every part regardless of who wrote it.

Thus, it is not the intent of this section to claim rights or contest your rights to work written entirely by you; rather, the intent is to exercise the right to control the distribution of derivative or collective works based on the Program.

In addition, mere aggregation of another work not based on the Program with the Program (or with a work based on the Program) on a volume of a storage or distribution medium does not bring the other work under the scope of this License.

3. You may copy and distribute the Program (or a work based on it, under Section 2) in object code or executable form under the terms of Sections 1 and 2 above provided that you also do one of the following:

- a) Accompany it with the complete corresponding machine-readable source code, which must be distributed under the terms of Sections 1 and 2 above on a medium customarily used for software interchange; or,

b) Accompany it with a written offer, valid for at least three years, to give any third party, for a charge no more than your cost of physically performing source distribution, a complete machine-readable copy of the corresponding source code, to be distributed under the terms of Sections 1 and 2 above on a medium customarily used for software interchange; or,

c) Accompany it with the information you received as to the offer to distribute corresponding source code. (This alternative is allowed only for noncommercial distribution and only if you received the program in object code or executable form with such an offer, in accord with Subsection b above.)

The source code for a work means the preferred form of the work for making modifications to it. For an executable work, complete source code means all the source code for all modules it contains, plus any associated interface definition files, plus the scripts used to control compilation and installation of the executable. However, as a special exception, the source code distributed need not include anything that is normally distributed (in either source or binary form) with the major components (compiler, kernel, and so on) of the operating system on which the executable runs, unless that component itself accompanies the executable.

If distribution of executable or object code is made by offering access to copy from a designated place, then offering equivalent access to copy the source code from the same place counts as distribution of the source code, even though third parties are not compelled to copy the source along with the object code.

4. You may not copy, modify, sublicense, or distribute the Program except as expressly provided under this License. Any attempt otherwise to copy, modify, sublicense or distribute the Program is void, and will automatically terminate your rights under this License. However, parties who have received copies, or rights, from you under this License will not have their licenses terminated so long as such parties remain in full compliance.

5. You are not required to accept this License, since you have not signed it. However, nothing else grants you permission to modify or distribute the Program or its derivative works. These actions are prohibited by law if you do not accept this License. Therefore, by modifying or distributing the Program (or any work based on the Program), you indicate your acceptance of this License to do so, and all its terms and conditions for copying, distributing or modifying the Program or works based on it.

6. Each time you redistribute the Program (or any work based on the Program), the recipient automatically receives a license from the original licensor to copy, distribute or modify the Program subject to these terms and conditions. You may not impose any further restrictions on the recipients' exercise of the rights granted herein. You are not responsible for enforcing compliance by third parties to this License.

7. If, as a consequence of a court judgment or allegation of patent infringement or for any other reason (not limited to patent issues), conditions are imposed on you (whether by court order, agreement or otherwise) that contradict the conditions of this License, they do not excuse you from the conditions of this License. If you cannot distribute so as to satisfy simultaneously your obligations under this License and any other pertinent obligations, then as a consequence you may not distribute the Program at all.

For example, if a patent license would not permit royalty-free redistribution of the Program by all those who receive copies directly or indirectly through you, then the only way you could satisfy both it and this License would be to refrain entirely from distribution of the Program.

If any portion of this section is held invalid or unenforceable under any particular circumstance, the balance of the section is intended to apply and the section as a whole is intended to apply in other circumstances.

It is not the purpose of this section to induce you to infringe any patents or other property right claims or to contest validity of any such claims; this section has the sole purpose of protecting the integrity of the free software distribution system, which is implemented by public license practices. Many people have made generous contributions to the wide range of software distributed through that system in reliance on consistent application of that system; it is up to the author/donor to decide if he or she is willing to distribute software through any other system and a licensee cannot impose that choice.

This section is intended to make thoroughly clear what is believed to be a consequence of the rest of this License.

8. If the distribution and/or use of the Program is restricted in certain countries either by patents or by copyrighted interfaces, the original copyright holder who places the Program under this License may add an explicit geographical distribution limitation excluding those countries, so that distribution is permitted only in or among countries not thus excluded. In such case, this License incorporates the limitation as if written in the body of this License.

9. The Free Software Foundation may publish revised and/or new versions of the General Public License from time to time. Such new versions will be similar in spirit to the present version, but may differ in detail to address new problems or concerns.

Each version is given a distinguishing version number. If the Program specifies a version number of this License which applies to it and "any later version", you have the option of following the terms and conditions either of that version or of any later version published by the Free Software Foundation. If the Program does not specify a version number of this License, you may choose any version ever published by the Free Software Foundation.

10. If you wish to incorporate parts of the Program into other free programs whose distribution conditions are different, write to the author to ask for permission. For software which is copyrighted by the Free Software Foundation, write to the Free Software Foundation; we sometimes make exceptions for this. Our decision will be guided by the two goals of preserving the free status of all derivatives of our free software and of promoting the sharing and reuse of software generally.

#### NO WARRANTY

11. BECAUSE THE PROGRAM IS LICENSED FREE OF CHARGE, THERE IS NO WARRANTY FOR THE PROGRAM, TO THE EXTENT PERMITTED BY APPLICABLE LAW. EXCEPT WHEN OTHERWISE STATED IN WRITING THE COPYRIGHT HOLDERS AND/OR OTHER PARTIES PROVIDE THE PROGRAM "AS IS" WITHOUT WARRANTY OF ANY KIND, EITHER EXPRESSED OR

IMPLIED, INCLUDING, BUT NOT LIMITED TO, THE IMPLIED WARRANTIES OF MERCHANTABILITY AND FITNESS FOR A PARTICULAR PURPOSE. THE ENTIRE RISK AS TO THE QUALITY AND PERFORMANCE OF THE PROGRAM IS WITH YOU. SHOULD THE PROGRAM PROVE DEFECTIVE, YOU ASSUME THE COST OF ALL NECESSARY SERVICING, REPAIR OR CORRECTION.

12. IN NO EVENT UNLESS REQUIRED BY APPLICABLE LAW OR AGREED TO IN WRITING WILL ANY COPYRIGHT HOLDER, OR ANY OTHER PARTY WHO MAY MODIFY AND/OR REDISTRIBUTE THE PROGRAM AS PERMITTED ABOVE, BE LIABLE TO YOU FOR DAMAGES, INCLUDING ANY GENERAL, SPECIAL, INCIDENTAL OR CONSEQUENTIAL DAMAGES ARISING OUT OF THE USE OR INABILITY TO USE THE PROGRAM (INCLUDING BUT NOT LIMITED TO LOSS OF DATA OR DATA BEING RENDERED INACCURATE OR LOSSES SUSTAINED BY YOU OR THIRD PARTIES OR A FAILURE OF THE PROGRAM TO OPERATE WITH ANY OTHER PROGRAMS), EVEN IF SUCH HOLDER OR OTHER PARTY HAS BEEN ADVISED OF THE POSSIBILITY OF SUCH DAMAGES.

END OF TERMS AND CONDITIONS

How to Apply These Terms to Your New Programs

If you develop a new program, and you want it to be of the greatest possible use to the public, the best way to achieve this is to make it free software which everyone can redistribute and change under these terms.

To do so, attach the following notices to the program. It is safest to attach them to the start of each source file to most effectively convey the exclusion of warranty; and each file should have at least the "copyright" line and a pointer to where the full notice is found.

<one line to give the program's name and a brief idea of what it does.>

Copyright (c) <year> <name of author>

This program is free software; you can redistribute it and/or modify it under the terms of the GNU General Public License as published by the Free Software Foundation; either version 2 of the License, or (at your option) any later version.

This program is distributed in the hope that it will be useful, but WITHOUT ANY WARRANTY; without even the implied warranty of MERCHANTABILITY or FITNESS FOR A PARTICULAR PURPOSE. See the GNU General Public License for more details.

You should have received a copy of the GNU General Public License along with this program; if not, write to the Free Software Foundation, Inc., 51 Franklin Street, Fifth Floor, Boston, MA 02110-1301 USA.

Also add information on how to contact you by electronic and paper mail.

If the program is interactive, make it output a short notice like this when it starts in an interactive mode:

Gnomovision version 69, Copyright (c) year name of author Gnomovision comes with ABSOLUTELY NO WARRANTY; for details type 'show w'. This is free software, and you are welcome to redistribute it under certain conditions; type 'show c' for details.

The hypothetical commands 'show w' and 'show c' should show the appropriate parts of the General Public License. Of course, the commands you use may be called something other than 'show w' and 'show c'; they could even be mouse-clicks or menu items--whatever suits your program.

You should also get your employer (if you work as a programmer) or your school, if any, to sign a "copyright disclaimer" for the program, if necessary. Here is a sample; alter the names:

Yoyodyne, Inc., hereby disclaims all copyright interest in the program 'Gnomovision' (which makes passes at compilers) written by James Hacker.

<signature of Ty Coon>, 1 April 1989

Ty Coon, President of Vice

This General Public License does not permit incorporating your program into proprietary programs. If your program is a subroutine library, you may consider it more useful to permit linking proprietary applications with the library. If this is what you want to do, use the GNU Lesser General Public License instead of this License.

#### GNU LGPL

This projector product includes the open source software programs which apply the GNU Lesser General Public License Version 2 or later version ("LGPL Programs").

We provide the source code of the LGPL Programs until five (5) years after the discontinuation of same model of this projector product.

If you desire to receive the source code of the LGPL Programs, contact Epson as described in the *User's Guide*.

These LGPL Programs are WITHOUT ANY WARRANTY; without even the implied warranty of MERCHANTABILITY AND FITNESS FOR A PARTICULAR PURPOSE. See the GNU General Public License for more details.

The list of LGPL Programs is as follows and the names of author are described in the source code of the LGPL Programs.

#### LGPL Programs

glibc-2.8

SDL-1.2.13

SDL-Image

The GNU Lesser General Public License Version 2 is as follows. You also can see the GNU Lesser General Public License Version 2 at <http://www.gnu.org/licenses/>.

## GNU LESSER GENERAL PUBLIC LICENSE

Version 2.1, February 1999

Copyright © 1991, 1999 Free Software Foundation, Inc. 51 Franklin Street, Fifth Floor, Boston, MA 02110-1301 USA Everyone is permitted to copy and distribute verbatim copies of this license document, but changing it is not allowed.

[This is the first released version of the Lesser GPL. It also counts as the successor of the GNU Library Public License, version 2, hence the version number 2.1.]

### Preamble

The licenses for most software are designed to take away your freedom to share and change it. By contrast, the GNU General Public Licenses are intended to guarantee your freedom to share and change free software--to make sure the software is free for all its users.

This license, the Lesser General Public License, applies to some specially designated software packages--typically libraries--of the Free Software Foundation and other authors who decide to use it. You can use it too, but we suggest you first think carefully about whether this license or the ordinary General Public License is the better strategy to use in any particular case, based on the explanations below.

When we speak of free software, we are referring to freedom of use, not price. Our General Public Licenses are designed to make sure that you have the freedom to distribute copies of free software (and charge for this service if you wish); that you receive source code or can get it if you want it; that you can change the software and use pieces of it in new free programs; and that you are informed that you can do these things.

To protect your rights, we need to make restrictions that forbid distributors to deny you these rights or to ask you to surrender these rights. These restrictions translate to certain responsibilities for you if you distribute copies of the library or if you modify it.

For example, if you distribute copies of the library, whether gratis or for a fee, you must give the recipients all the rights that we gave you. You must make sure that they, too, receive or can get the source code. If you link other code with the library, you must provide complete object files to the recipients, so that they can relink them with the library after making changes to the library and recompiling it. And you must show them these terms so they know their rights.

We protect your rights with a two-step method: (1) we copyright the library, and (2) we offer you this license, which gives you legal permission to copy, distribute and/or modify the library.

To protect each distributor, we want to make it very clear that there is no warranty for the free library. Also, if the library is modified by someone else and passed on, the recipients should know that what they



have is not the original version, so that the original author's reputation will not be affected by problems that might be introduced by others.

Finally, software patents pose a constant threat to the existence of any free program. We wish to make sure that a company cannot effectively restrict the users of a free program by obtaining a restrictive license from a patent holder. Therefore, we insist that any patent license obtained for a version of the library must be consistent with the full freedom of use specified in this license.

Most GNU software, including some libraries, is covered by the ordinary GNU General Public License. This license, the GNU Lesser General Public License, applies to certain designated libraries, and is quite different from the ordinary General Public License. We use this license for certain libraries in order to permit linking those libraries into non-free programs.

When a program is linked with a library, whether statically or using a shared library, the combination of the two is legally speaking a combined work, a derivative of the original library. The ordinary General Public License therefore permits such linking only if the entire combination fits its criteria of freedom. The Lesser General Public License permits more lax criteria for linking other code with the library.

We call this license the "Lesser" General Public License because it does Less to protect the user's freedom than the ordinary General Public License. It also provides other free software developers Less of an advantage over competing non-free programs. These disadvantages are the reason we use the ordinary General Public License for many libraries. However, the Lesser license provides advantages in certain special circumstances.

For example, on rare occasions, there may be a special need to encourage the widest possible use of a certain library, so that it becomes a de-facto standard. To achieve this, non-free programs must be allowed to use the library. A more frequent case is that a free library does the same job as widely used non-free libraries. In this case, there is little to gain by limiting the free library to free software only, so we use the Lesser General Public License.

In other cases, permission to use a particular library in non-free programs enables a greater number of people to use a large body of free software. For example, permission to use the GNU C Library in non-free programs enables many more people to use the whole GNU operating system, as well as its variant, the GNU/Linux operating system.

Although the Lesser General Public License is Less protective of the users' freedom, it does ensure that the user of a program that is linked with the Library has the freedom and the wherewithal to run that program using a modified version of the Library.

The precise terms and conditions for copying, distribution and modification follow. Pay close attention to the difference between a "work based on the library" and a "work that uses the library". The former contains code derived from the library, whereas the latter must be combined with the library in order to run.

GNU LESSER GENERAL PUBLIC LICENSE TERMS AND CONDITIONS FOR COPYING,  
DISTRIBUTION AND MODIFICATION

0. This License Agreement applies to any software library or other program which contains a notice placed by the copyright holder or other authorized party saying it may be distributed under the terms of this Lesser General Public License (also called "this License"). Each licensee is addressed as "you".

A "library" means a collection of software functions and/or data prepared so as to be conveniently linked with application programs (which use some of those functions and data) to form executables.

The "Library", below, refers to any such software library or work which has been distributed under these terms. A "work based on the Library" means either the Library or any derivative work under copyright law: that is to say, a work containing the Library or a portion of it, either verbatim or with modifications and/or translated straightforwardly into another language. (Hereinafter, translation is included without limitation in the term "modification".)

"Source code" for a work means the preferred form of the work for making modifications to it. For a library, complete source code means all the source code for all modules it contains, plus any associated interface definition files, plus the scripts used to control compilation and installation of the library.

Activities other than copying, distribution and modification are not covered by this License; they are outside its scope. The act of running a program using the Library is not restricted, and output from such a program is covered only if its contents constitute a work based on the Library (independent of the use of the Library in a tool for writing it). Whether that is true depends on what the Library does and what the program that uses the Library does.

1. You may copy and distribute verbatim copies of the Library's complete source code as you receive it, in any medium, provided that you conspicuously and appropriately publish on each copy an appropriate copyright notice and disclaimer of warranty; keep intact all the notices that refer to this License and to the absence of any warranty; and distribute a copy of this License along with the Library.

You may charge a fee for the physical act of transferring a copy, and you may at your option offer warranty protection in exchange for a fee.

2. You may modify your copy or copies of the Library or any portion of it, thus forming a work based on the Library, and copy and distribute such modifications or work under the terms of Section 1 above, provided that you also meet all of these conditions:

a) The modified work must itself be a software library.

b) You must cause the files modified to carry prominent notices stating that you changed the files and the date of any change.

c) You must cause the whole of the work to be licensed at no charge to all third parties under the terms of this License.

d) If a facility in the modified Library refers to a function or a table of data to be supplied by an application program that uses the facility, other than as an argument passed when the facility is invoked, then you must make a good faith effort to ensure that, in the event an application does not supply such function or table, the facility still operates, and performs whatever part of its purpose remains meaningful.

(For example, a function in a library to compute square roots has a purpose that is entirely well-defined independent of the application. Therefore, Subsection 2d requires that any application-supplied function or table used by this function must be optional: if the application does not supply it, the square root function must still compute square roots.)

These requirements apply to the modified work as a whole. If identifiable sections of that work are not derived from the Library, and can be reasonably considered independent and separate works in themselves, then this License, and its terms, do not apply to those sections when you distribute them as separate works. But when you distribute the same sections as part of a whole which is a work based on the Library, the distribution of the whole must be on the terms of this License, whose permissions for other licensees extend to the entire whole, and thus to each and every part regardless of who wrote it.

Thus, it is not the intent of this section to claim rights or contest your rights to work written entirely by you; rather, the intent is to exercise the right to control the distribution of derivative or collective works based on the Library.

In addition, mere aggregation of another work not based on the Library with the Library (or with a work based on the Library) on a volume of a storage or distribution medium does not bring the other work under the scope of this License.

3. You may opt to apply the terms of the ordinary GNU General Public License instead of this License to a given copy of the Library. To do this, you must alter all the notices that refer to this License, so that they refer to the ordinary GNU General Public License, version 2, instead of to this License. (If a newer version than version 2 of the ordinary GNU General Public License has appeared, then you can specify that version instead if you wish.) Do not make any other change in these notices.

Once this change is made in a given copy, it is irreversible for that copy, so the ordinary GNU General Public License applies to all subsequent copies and derivative works made from that copy.

This option is useful when you wish to copy part of the code of the Library into a program that is not a library.

4. You may copy and distribute the Library (or a portion or derivative of it, under Section 2) in object code or executable form under the terms of Sections 1 and 2 above provided that you accompany it with the complete corresponding machine-readable source code, which must be distributed under the terms of Sections 1 and 2 above on a medium customarily used for software interchange.

If distribution of object code is made by offering access to copy from a designated place, then offering equivalent access to copy the source code from the same place satisfies the requirement to distribute the source code, even though third parties are not compelled to copy the source along with the object code.

5. A program that contains no derivative of any portion of the Library, but is designed to work with the Library by being compiled or linked with it, is called a "work that uses the Library". Such a work, in isolation, is not a derivative work of the Library, and therefore falls outside the scope of this License.

However, linking a "work that uses the Library" with the Library creates an executable that is a derivative of the Library (because it contains portions of the Library), rather than a "work that uses the library". The executable is therefore covered by this License. Section 6 states terms for distribution of such executables.

When a "work that uses the Library" uses material from a header file that is part of the Library, the object code for the work may be a derivative work of the Library even though the source code is not. Whether this is true is especially significant if the work can be linked without the Library, or if the work is itself a library. The threshold for this to be true is not precisely defined by law.

If such an object file uses only numerical parameters, data structure layouts and accessors, and small macros and small inline functions (ten lines or less in length), then the use of the object file is unrestricted, regardless of whether it is legally a derivative work. (Executables containing this object code plus portions of the Library will still fall under Section 6.)

Otherwise, if the work is a derivative of the Library, you may distribute the object code for the work under the terms of Section 6. Any executables containing that work also fall under Section 6, whether or not they are linked directly with the Library itself.

6. As an exception to the Sections above, you may also combine or link a "work that uses the Library" with the Library to produce a work containing portions of the Library, and distribute that work under terms of your choice, provided that the terms permit modification of the work for the customer's own use and reverse engineering for debugging such modifications.

You must give prominent notice with each copy of the work that the Library is used in it and that the Library and its use are covered by this License. You must supply a copy of this License. If the work during execution displays copyright notices, you must include the copyright notice for the Library among them, as well as a reference directing the user to the copy of this License. Also, you must do one of these things:

a) Accompany the work with the complete corresponding machine-readable source code for the Library including whatever changes were used in the work (which must be distributed under Sections 1 and 2 above); and, if the work is an executable linked with the Library, with the complete machine-readable "work that uses the Library", as object code and/or source code, so that the user can modify the Library and then relink to produce a modified executable containing the modified Library. (It is understood that the user who changes the contents of definitions files in the Library will not necessarily be able to recompile the application to use the modified definitions.)

b) Use a suitable shared library mechanism for linking with the Library. A suitable mechanism is one that (1) uses at run time a copy of the library already present on the user's computer system, rather than copying library functions into the executable, and (2) will operate properly with a modified version of the library, if the user installs one, as long as the modified version is interface-compatible with the version that the work was made with.

- c) Accompany the work with a written offer, valid for at least three years, to give the same user the materials specified in Subsection 6a, above, for a charge no more than the cost of performing this distribution.
- d) If distribution of the work is made by offering access to copy from a designated place, offer equivalent access to copy the above specified materials from the same place.
- e) Verify that the user has already received a copy of these materials or that you have already sent this user a copy.

For an executable, the required form of the "work that uses the Library" must include any data and utility programs needed for reproducing the executable from it. However, as a special exception, the materials to be distributed need not include anything that is normally distributed (in either source or binary form) with the major components (compiler, kernel, and so on) of the operating system on which the executable runs, unless that component itself accompanies the executable.

It may happen that this requirement contradicts the license restrictions of other proprietary libraries that do not normally accompany the operating system. Such a contradiction means you cannot use both them and the Library together in an executable that you distribute.

7. You may place library facilities that are a work based on the Library side-by-side in a single library together with other library facilities not covered by this License, and distribute such a combined library, provided that the separate distribution of the work based on the Library and of the other library facilities is otherwise permitted, and provided that you do these two things:

- a) Accompany the combined library with a copy of the same work based on the Library, uncombined with any other library facilities. This must be distributed under the terms of the Sections above.
- b) Give prominent notice with the combined library of the fact that part of it is a work based on the Library, and explaining where to find the accompanying uncombined form of the same work.

8. You may not copy, modify, sublicense, link with, or distribute the Library except as expressly provided under this License. Any attempt otherwise to copy, modify, sublicense, link with, or distribute the Library is void, and will automatically terminate your rights under this License. However, parties who have received copies, or rights, from you under this License will not have their licenses terminated so long as such parties remain in full compliance.

9. You are not required to accept this License, since you have not signed it. However, nothing else grants you permission to modify or distribute the Library or its derivative works. These actions are prohibited by law if you do not accept this License. Therefore, by modifying or distributing the Library (or any work based on the Library), you indicate your acceptance of this License to do so, and all its terms and conditions for copying, distributing or modifying the Library or works based on it.

10. Each time you redistribute the Library (or any work based on the Library), the recipient automatically receives a license from the original licensor to copy, distribute, link with or modify the Library subject to these terms and conditions. You may not impose any further restrictions on the recipients' exercise of

the rights granted herein. You are not responsible for enforcing compliance by third parties with this License.

11. If, as a consequence of a court judgment or allegation of patent infringement or for any other reason (not limited to patent issues), conditions are imposed on you (whether by court order, agreement or otherwise) that contradict the conditions of this License, they do not excuse you from the conditions of this License. If you cannot distribute so as to satisfy simultaneously your obligations under this License and any other pertinent obligations, then as a consequence you may not distribute the Library at all. For example, if a patent license would not permit royalty-free redistribution of the Library by all those who receive copies directly or indirectly through you, then the only way you could satisfy both it and this License would be to refrain entirely from distribution of the Library.

If any portion of this section is held invalid or unenforceable under any particular circumstance, the balance of the section is intended to apply, and the section as a whole is intended to apply in other circumstances.

It is not the purpose of this section to induce you to infringe any patents or other property right claims or to contest validity of any such claims; this section has the sole purpose of protecting the integrity of the free software distribution system which is implemented by public license practices. Many people have made generous contributions to the wide range of software distributed through that system in reliance on consistent application of that system; it is up to the author/donor to decide if he or she is willing to distribute software through any other system and a licensee cannot impose that choice.

This section is intended to make thoroughly clear what is believed to be a consequence of the rest of this License.

12. If the distribution and/or use of the Library is restricted in certain countries either by patents or by copyrighted interfaces, the original copyright holder who places the Library under this License may add an explicit geographical distribution limitation excluding those countries, so that distribution is permitted only in or among countries not thus excluded. In such case, this License incorporates the limitation as if written in the body of this License.

13. The Free Software Foundation may publish revised and/or new versions of the Lesser General Public License from time to time. Such new versions will be similar in spirit to the present version, but may differ in detail to address new problems or concerns.

Each version is given a distinguishing version number. If the Library specifies a version number of this License which applies to it and "any later version", you have the option of following the terms and conditions either of that version or of any later version published by the Free Software Foundation. If the Library does not specify a license version number, you may choose any version ever published by the Free Software Foundation.

14. If you wish to incorporate parts of the Library into other free programs whose distribution conditions are incompatible with these, write to the author to ask for permission. For software which is copyrighted by the Free Software Foundation, write to the Free Software Foundation; we sometimes make

exceptions for this. Our decision will be guided by the two goals of preserving the free status of all derivatives of our free software and of promoting the sharing and reuse of software generally.

#### NO WARRANTY

15. BECAUSE THE LIBRARY IS LICENSED FREE OF CHARGE, THERE IS NO WARRANTY FOR THE LIBRARY, TO THE EXTENT PERMITTED BY APPLICABLE LAW. EXCEPT WHEN OTHERWISE STATED IN WRITING THE COPYRIGHT HOLDERS AND/OR OTHER PARTIES PROVIDE THE LIBRARY "AS IS" WITHOUT WARRANTY OF ANY KIND, EITHER EXPRESSED OR IMPLIED, INCLUDING, BUT NOT LIMITED TO, THE IMPLIED WARRANTIES OF MERCHANTABILITY AND FITNESS FOR A PARTICULAR PURPOSE. THE ENTIRE RISK AS TO THE QUALITY AND PERFORMANCE OF THE LIBRARY IS WITH YOU. SHOULD THE LIBRARY PROVE DEFECTIVE, YOU ASSUME THE COST OF ALL NECESSARY SERVICING, REPAIR OR CORRECTION.

16. IN NO EVENT UNLESS REQUIRED BY APPLICABLE LAW OR AGREED TO IN WRITING WILL ANY COPYRIGHT HOLDER, OR ANY OTHER PARTY WHO MAY MODIFY AND/OR REDISTRIBUTE THE LIBRARY AS PERMITTED ABOVE, BE LIABLE TO YOU FOR DAMAGES, INCLUDING ANY GENERAL, SPECIAL, INCIDENTAL OR CONSEQUENTIAL DAMAGES ARISING OUT OF THE USE OR INABILITY TO USE THE LIBRARY (INCLUDING BUT NOT LIMITED TO LOSS OF DATA OR DATA BEING RENDERED INACCURATE OR LOSSES SUSTAINED BY YOU OR THIRD PARTIES OR A FAILURE OF THE LIBRARY TO OPERATE WITH ANY OTHER SOFTWARE), EVEN IF SUCH HOLDER OR OTHER PARTY HAS BEEN ADVISED OF THE POSSIBILITY OF SUCH DAMAGES.

#### END OF TERMS AND CONDITIONS

#### How to Apply These Terms to Your New Libraries

If you develop a new library, and you want it to be of the greatest possible use to the public, we recommend making it free software that everyone can redistribute and change. You can do so by permitting redistribution under these terms (or, alternatively, under the terms of the ordinary General Public License).

To apply these terms, attach the following notices to the library. It is safest to attach them to the start of each source file to most effectively convey the exclusion of warranty; and each file should have at least the "copyright" line and a pointer to where the full notice is found.

<one line to give the library's name and a brief idea of what it does.>

Copyright (c) <year> <name of author>

This library is free software; you can redistribute it and/or modify it under the terms of the GNU Lesser General Public License as published by the Free Software Foundation; either version 2.1 of the License, or (at your option) any later version.

This library is distributed in the hope that it will be useful, but WITHOUT ANY WARRANTY; without even the implied warranty of MERCHANTABILITY or FITNESS FOR A PARTICULAR PURPOSE. See the GNU Lesser General Public License for more details.

You should have received a copy of the GNU Lesser General Public License along with this library; if not, write to the Free Software Foundation, Inc., 51 Franklin Street, Fifth Floor, Boston, MA 02110-1301 USA

Also add information on how to contact you by electronic and paper mail.

You should also get your employer (if you work as a programmer) or your school, if any, to sign a "copyright disclaimer" for the library, if necessary. Here is a sample; alter the names:

Yoyodyne, Inc., hereby disclaims all copyright interest in the library 'Frob' (a library for tweaking knobs) written by James Random Hacker.

<signature of Ty Coon>, 1 April 1990

Ty Coon, President of Vice

That's all there is to it!

BSD License (Berkeley Software Distribution License)

This projector product includes the open source software program "University of California, Berkeley License (Berkeley Software Distribution License)" which applies the terms and conditions provided by owner of the copyright to the "BSD License".

The "BSD License" are WITHOUT ANY WARRANTY; without even the implied warranty of MERCHANTABILITY AND FITNESS FOR A PARTICULAR PURPOSE.

List of BSD License programs

busybox-1.13.4

License terms of conditions of each program which are provided by owner of the copyright to the "BSD License" are as follows.

Copyright (c) The Regents of the University of California. All rights reserved.

This code is derived from software contributed to Berkeley by Kenneth Almquist.

Redistribution and use in source and binary forms, with or without modification, are permitted provided that the following conditions are met:

1. Redistributions of source code must retain the above copyright notice, this list of conditions and the following disclaimer.
2. Redistributions in binary form must reproduce the above copyright notice, this list of conditions and the following disclaimer in the documentation and/or other materials provided with the distribution.
3. Neither the name of the University nor the names of its contributors may be used to endorse or promote products derived from this software without specific prior written permission.



THIS SOFTWARE IS PROVIDED BY THE REGENTS AND CONTRIBUTORS "AS IS" AND ANY EXPRESS OR IMPLIED WARRANTIES, INCLUDING, BUT NOT LIMITED TO, THE IMPLIED WARRANTIES OF MERCHANTABILITY AND FITNESS FOR A PARTICULAR PURPOSE ARE DISCLAIMED. IN NO EVENT SHALL THE REGENTS OR CONTRIBUTORS BE LIABLE FOR ANY DIRECT, INDIRECT, INCIDENTAL, SPECIAL, EXEMPLARY, OR CONSEQUENTIAL DAMAGES (INCLUDING, BUT NOT LIMITED TO, PROCUREMENT OF SUBSTITUTE GOODS OR SERVICES; LOSS OF USE, DATA, OR PROFITS; OR BUSINESS INTERRUPTION) HOWEVER CAUSED AND ON ANY THEORY OF LIABILITY, WHETHER IN CONTRACT, STRICT LIABILITY, OR TORT (INCLUDING NEGLIGENCE OR OTHERWISE) ARISING IN ANY WAY OUT OF THE USE OF THIS SOFTWARE, EVEN IF ADVISED OF THE POSSIBILITY OF SUCH DAMAGE.

libjpeg

This projector product includes the open source software program "libjpeg" which applies the terms and conditions provided by owner of the copyright to the "libjpeg".

The "libjpeg" are WITHOUT ANY WARRANTY; without even the implied warranty of MERCHANTABILITY AND FITNESS FOR A PARTICULAR PURPOSE.

List of libjpeg programs

libjpeg-6b

License terms of conditions of each program which are provided by owner of the copyright to the "libjpeg" are as follows.

Copyright (c) 1994-1997, Thomas G. Lane. This file is part of the Independent JPEG Group's software. For conditions of distribution and use, see the accompanying README file.

This distribution contains the sixth public release of the Independent JPEG Group's free JPEG software. You are welcome to redistribute this software and to use it for any purpose, subject to the conditions under LEGAL ISSUES, below.

LEGAL ISSUES

=====

In plain English:

1. We don't promise that this software works. (But if you find any bugs, please let us know!)
2. You can use this software for whatever you want. You don't have to pay us.
3. You may not pretend that you wrote this software. If you use it in a program, you must acknowledge somewhere in your documentation that you've used the IJG code.

In legalese:

The authors make NO WARRANTY or representation, either express or implied, with respect to this software, its quality, accuracy, merchantability, or fitness for a particular purpose. This software is provided "AS IS", and you, its user, assume the entire risk as to its quality and accuracy.

This software is copyright (c) 1991-1998, Thomas G. Lane. All Rights Reserved except as specified below.

Permission is hereby granted to use, copy, modify, and distribute this software (or portions thereof) for any purpose, without fee, subject to these conditions:

(1) If any part of the source code for this software is distributed, then this README file must be included, with this copyright and no-warranty notice unaltered; and any additions, deletions, or changes to the original files must be clearly indicated in accompanying documentation.

(2) If only executable code is distributed, then the accompanying documentation must state that "this software is based in part on the work of the Independent JPEG Group".

(3) Permission for use of this software is granted only if the user accepts full responsibility for any undesirable consequences; the authors accept NO LIABILITY for damages of any kind.

These conditions apply to any software derived from or based on the IJG code, not just to the unmodified library. If you use our work, you ought to acknowledge us.

Permission is NOT granted for the use of any IJG author's name or company name in advertising or publicity relating to this software or products derived from it. This software may be referred to only as "the Independent JPEG Group's software".

We specifically permit and encourage the use of this software as the basis of commercial products, provided that all warranty or liability claims are assumed by the product vendor.

ansi2knr.c is included in this distribution by permission of L. Peter Deutsch, sole proprietor of its copyright holder, Aladdin Enterprises of Menlo Park, CA. ansi2knr.c is NOT covered by the above copyright and conditions, but instead by the usual distribution terms of the Free Software Foundation; principally, that you must include source code if you redistribute it. (See the file ansi2knr.c for full details.) However, since ansi2knr.c is not needed as part of any program generated from the IJG code, this does not limit you more than the foregoing paragraphs do.

The Unix configuration script "configure" was produced with GNU Autoconf. It is copyright by the Free Software Foundation but is freely distributable. The same holds for its supporting scripts (config.guess, config.sub, ltconfig, ltmain.sh). Another support script, install-sh, is copyright by M.I.T. but is also freely distributable.

It appears that the arithmetic coding option of the JPEG spec is covered by patents owned by IBM, AT&T, and Mitsubishi. Hence arithmetic coding cannot legally be used without obtaining one or more licenses. For this reason, support for arithmetic coding has been removed from the free JPEG software. (Since arithmetic coding provides only a marginal gain over the unpatented Huffman mode, it is unlikely

that very many implementations will support it.) So far as we are aware, there are no patent restrictions on the remaining code.

The IJG distribution formerly included code to read and write GIF files. To avoid entanglement with the Unisys LZW patent, GIF reading support has been removed altogether, and the GIF writer has been simplified to produce "uncompressed GIFs". This technique does not use the LZW algorithm; the resulting GIF files are larger than usual, but are readable by all standard GIF decoders.

We are required to state that

"The Graphics Interchange Format (c) is the Copyright property of CompuServe Incorporated. GIF(sm) is a Service Mark property of CompuServe Incorporated."

libpng

This projector product includes the open source software program "libpng" which applies the terms and conditions provided by owner of the copyright to the "libpng".

The "libpng" are WITHOUT ANY WARRANTY; without even the implied warranty of MERCHANTABILITY AND FITNESS FOR A PARTICULAR PURPOSE.

List of libpng programs

libpng-1.2.49

License terms of conditions of each program which are provided by owner of the copyright to the "libpng" are as follows.

For conditions of distribution and use, see copyright notice in png.h Copyright (c) 1998-2012 Glenn Randers-Pehrson (Version 0.96 Copyright (c) 1996, 1997 Andreas Dilger) (Version 0.88 Copyright © 1995, 1996 Guy Eric Schalnat, Group 42, Inc.)

This copy of the libpng notices is provided for your convenience. In case of any discrepancy between this copy and the notices in the file png.h that is included in the libpng distribution, the latter shall prevail.

COPYRIGHT NOTICE, DISCLAIMER, and LICENSE:

If you modify libpng you may insert additional notices immediately following this sentence.

This code is released under the libpng license.

libpng version 1.2.6, August 15, 2004, through 1.2.49, March 29, 2012, are Copyright (c) 2004, 2006-2009 Glenn Randers-Pehrson, and are distributed according to the same disclaimer and license as libpng-1.2.5 with the following individual added to the list of Contributing Authors

Cosmin Truta

libpng versions 1.0.7, July 1, 2000, through 1.2.5 - October 3, 2002, are Copyright (c) 2000-2002 Glenn Randers-Pehrson, and are distributed according to the same disclaimer and license as libpng-1.0.6 with the following individuals added to the list of Contributing Authors

Simon-Pierre Cadieux

Eric S. Raymond

Gilles Vollant

and with the following additions to the disclaimer:

There is no warranty against interference with your enjoyment of the library or against infringement. There is no warranty that our efforts or the library will fulfill any of your particular purposes or needs. This library is provided with all faults, and the entire risk of satisfactory quality, performance, accuracy, and effort is with the user.

libpng versions 0.97, January 1998, through 1.0.6, March 20, 2000, are Copyright © 1998, 1999 Glenn Randers-Pehrson, and are distributed according to the same disclaimer and license as libpng-0.96, with the following individuals added to the list of Contributing Authors:

Tom Lane

Glenn Randers-Pehrson

Willem van Schaik

libpng versions 0.89, June 1996, through 0.96, May 1997, are Copyright (c) 1996, 1997 Andreas Dilger Distributed according to the same disclaimer and license as libpng-0.88, with the following individuals added to the list of Contributing Authors:

John Bowler

Kevin Bracey

Sam Bushell

Magnus Holmgren

Greg Roelofs

Tom Tanner

libpng versions 0.5, May 1995, through 0.88, January 1996, are Copyright (c) 1995, 1996 Guy Eric Schalnat, Group 42, Inc.

For the purposes of this copyright and license, "Contributing Authors" is defined as the following set of individuals:

Andreas Dilger

Dave Martindale

Guy Eric Schalnat

Paul Schmidt

Tim Wegner

The PNG Reference Library is supplied "AS IS". The Contributing Authors and Group 42, Inc. disclaim all warranties, expressed or implied, including, without limitation, the warranties of merchantability and of fitness for any purpose. The Contributing Authors and Group 42, Inc. assume no liability for direct, indirect, incidental, special, exemplary, or consequential damages, which may result from the use of the PNG Reference Library, even if advised of the possibility of such damage.

Permission is hereby granted to use, copy, modify, and distribute this source code, or portions hereof, for any purpose, without fee, subject to the following restrictions:

1. The origin of this source code must not be misrepresented.
2. Altered versions must be plainly marked as such and must not be misrepresented as being the original source.
3. This Copyright notice may not be removed or altered from any source or altered source distribution.

The Contributing Authors and Group 42, Inc. specifically permit, without fee, and encourage the use of this source code as a component to supporting the PNG file format in commercial products. If you use this source code in a product, acknowledgment is not required but would be appreciated.

A "png\_get\_copyright" function is available, for convenient use in "about" boxes and the like:

```
printf("%s",png_get_copyright(NULL));
```

Also, the PNG logo (in PNG format, of course) is supplied in the files "pngbar.png" and "pngbar.jpg" (88x31) and "pngnow.png" (98x31).

Libpng is OSI Certified Open Source Software. OSI Certified Open Source is a certification mark of the Open Source Initiative.

Glenn Randers-Pehrson

glennrp@users.sourceforge.net

March 29, 2012

zlib

This projector product includes the open source software program "zlib" which applies the terms and conditions provided by owner of the copyright to the "zlib".

The "zlib" are WITHOUT ANY WARRANTY; without even the implied warranty of MERCHANTABILITY AND FITNESS FOR A PARTICULAR PURPOSE.

List of zlib programs

zlib-1.1.4

License terms of conditions of each program which are provided by owner of the copyright to the "zlib" are as follows.

Copyright notice:

(c) 1995-1998 Jean-loup Gailly and Mark Adler

This software is provided 'as-is', without any express or implied warranty. In no event will the authors be held liable for any damages arising from the use of this software.

Permission is granted to anyone to use this software for any purpose, including commercial applications, and to alter it and redistribute it freely, subject to the following restrictions:

1. The origin of this software must not be misrepresented; you must not claim that you wrote the original software. If you use this software in a product, an acknowledgment in the product documentation would be appreciated but is not required.
2. Altered source versions must be plainly marked as such, and must not be misrepresented as being the original software.
3. This notice may not be removed or altered from any source distribution.

Jean-loup Gailly

jloup@gzip.org

Mark Adler

madler@alumni.caltech.edu

If you use the zlib library in a product, we would appreciate \*not\* receiving lengthy legal documents to sign. The sources are provided for free but without warranty of any kind. The library has been entirely written by Jean-loup Gailly and Mark Adler; it does not include third-party code.

If you redistribute modified sources, we would appreciate that you include in the file ChangeLog history information documenting your changes.

Apache-2.0

This projector product includes the open source software program which applies the following license terms "Apache License Version 2.0, January 2004".

mDNSResponder-107.6 (only mDNSResponderPosix is used)

DroidSansFallback.ttf

License terms "Apache License Version 2.0, January 2004" are as follows.

Apache License

Version 2.0, January 2004

<http://www.apache.org/licenses/>

## TERMS AND CONDITIONS FOR USE, REPRODUCTION, AND DISTRIBUTION

### 1. Definitions.

"License" shall mean the terms and conditions for use, reproduction, and distribution as defined by Sections 1 through 9 of this document.

"Licensor" shall mean the copyright owner or entity authorized by the copyright owner that is granting the License.

"Legal Entity" shall mean the union of the acting entity and all other entities that control, are controlled by, or are under common control with that entity. For the purposes of this definition, "control" means (i) the power, direct or indirect, to cause the direction or management of such entity, whether by contract or otherwise, or (ii) ownership of fifty percent (50%) or more of the outstanding shares, or (iii) beneficial ownership of such entity.

"You" (or "Your") shall mean an individual or Legal Entity exercising permissions granted by this License.

"Source" form shall mean the preferred form for making modifications, including but not limited to software source code, documentation source, and configuration files.

"Object" form shall mean any form resulting from mechanical transformation or translation of a Source form, including but not limited to compiled object code, generated documentation, and conversions to other media types.

"Work" shall mean the work of authorship, whether in Source or Object form, made available under the License, as indicated by a copyright notice that is included in or attached to the work (an example is provided in the Appendix below).

"Derivative Works" shall mean any work, whether in Source or Object form, that is based on (or derived from) the Work and for which the editorial revisions, annotations, elaborations, or other modifications represent, as a whole, an original work of authorship. For the purposes of this License, Derivative Works shall not include works that remain separable from, or merely link (or bind by name) to the interfaces of, the Work and Derivative Works thereof.

"Contribution" shall mean any work of authorship, including the original version of the Work and any modifications or additions to that Work or Derivative Works thereof, that is intentionally submitted to Licensor for inclusion in the Work by the copyright owner or by an individual or Legal Entity authorized to submit on behalf of the copyright owner. For the purposes of this definition, "submitted" means any form of electronic, verbal, or written communication sent to the Licensor or its representatives, including but not limited to communication on electronic mailing lists, source code control systems, and issue tracking systems that are managed by, or on behalf of, the Licensor for the purpose of discussing and improving the Work, but excluding communication that is conspicuously marked or otherwise designated in writing by the copyright owner as "Not a Contribution."

"Contributor" shall mean Licensor and any individual or Legal Entity on behalf of whom a Contribution has been received by Licensor and subsequently incorporated within the Work.

2. Grant of Copyright License. Subject to the terms and conditions of this License, each Contributor hereby grants to You a perpetual, worldwide, non-exclusive, no-charge, royalty-free, irrevocable copyright license to reproduce, prepare Derivative Works of, publicly display, publicly perform, sublicense, and distribute the Work and such Derivative Works in Source or Object form.

3. Grant of Patent License. Subject to the terms and conditions of this License, each Contributor hereby grants to You a perpetual, worldwide, non-exclusive, no-charge, royalty-free, irrevocable (except as stated in this section) patent license to make, have made, use, offer to sell, sell, import, and otherwise transfer the Work, where such license applies only to those patent claims licensable by such Contributor that are necessarily infringed by their Contribution(s) alone or by combination of their Contribution(s) with the Work to which such Contribution(s) was submitted. If You institute patent litigation against any entity (including a cross-claim or counterclaim in a lawsuit) alleging that the Work or a Contribution incorporated within the Work constitutes direct or contributory patent infringement, then any patent licenses granted to You under this License for that Work shall terminate as of the date such litigation is filed.

4. Redistribution. You may reproduce and distribute copies of the Work or Derivative Works thereof in any medium, with or without modifications, and in Source or Object form, provided that You meet the following conditions:

(a) You must give any other recipients of the Work or Derivative Works a copy of this License; and

(b) You must cause any modified files to carry prominent notices stating that You changed the files; and

(c) You must retain, in the Source form of any Derivative Works that You distribute, all copyright, patent, trademark, and attribution notices from the Source form of the Work, excluding those notices that do not pertain to any part of the Derivative Works; and

(d) If the Work includes a "NOTICE" text file as part of its distribution, then any Derivative Works that You distribute must include a readable copy of the attribution notices contained within such NOTICE file, excluding those notices that do not pertain to any part of the Derivative Works, in at least one of the following places: within a NOTICE text file distributed as part of the Derivative Works; within the Source form or documentation, if provided along with the Derivative Works; or, within a display generated by the Derivative Works, if and wherever such third-party notices normally appear. The contents of the NOTICE file are for informational purposes only and do not modify the License. You may add Your own attribution notices within Derivative Works that You distribute, alongside or as an addendum to the NOTICE text from the Work, provided that such additional attribution notices cannot be construed as modifying the License.

You may add Your own copyright statement to Your modifications and may provide additional or different license terms and conditions for use, reproduction, or distribution of Your modifications, or for any such



Derivative Works as a whole, provided Your use, reproduction, and distribution of the Work otherwise complies with the conditions stated in this License.

5. Submission of Contributions. Unless You explicitly state otherwise, any Contribution intentionally submitted for inclusion in the Work by You to the Licensor shall be under the terms and conditions of this License, without any additional terms or conditions.

Notwithstanding the above, nothing herein shall supersede or modify the terms of any separate license agreement you may have executed with Licensor regarding such Contributions.

6. Trademarks. This License does not grant permission to use the trade names, trademarks, service marks, or product names of the Licensor, except as required for reasonable and customary use in describing the origin of the Work and reproducing the content of the NOTICE file.

7. Disclaimer of Warranty. Unless required by applicable law or agreed to in writing, Licensor provides the Work (and each Contributor provides its Contributions) on an "AS IS" BASIS, WITHOUT WARRANTIES OR CONDITIONS OF ANY KIND, either express or implied, including, without limitation, any warranties or conditions of TITLE, NON-INFRINGEMENT, MERCHANTABILITY, or FITNESS FOR A PARTICULAR PURPOSE. You are solely responsible for determining the appropriateness of using or redistributing the Work and assume any risks associated with Your exercise of permissions under this License.

8. Limitation of Liability. In no event and under no legal theory, whether in tort (including negligence), contract, or otherwise, unless required by applicable law (such as deliberate and grossly negligent acts) or agreed to in writing, shall any Contributor be liable to You for damages, including any direct, indirect, special, incidental, or consequential damages of any character arising as a result of this License or out of the use or inability to use the Work (including but not limited to damages for loss of goodwill, work stoppage, computer failure or malfunction, or any and all other commercial damages or losses), even if such Contributor has been advised of the possibility of such damages.

9. Accepting Warranty or Additional Liability. While redistributing the Work or Derivative Works thereof, You may choose to offer, and charge a fee for, acceptance of support, warranty, indemnity, or other liability obligations and/or rights consistent with this License. However, in accepting such obligations, You may act only on Your own behalf and on Your sole responsibility, not on behalf of any other Contributor, and only if You agree to indemnify, defend, and hold each Contributor harmless for any liability incurred by, or claims asserted against, such Contributor by reason of your accepting any such warranty or additional liability.

END OF TERMS AND CONDITIONS

APPENDIX: How to apply the Apache License to your work.

To apply the Apache License to your work, attach the following boilerplate notice, with the fields enclosed by brackets "[]" replaced with your own identifying information. (Don't include the brackets!) The text should be enclosed in the appropriate comment syntax for the file format. We also recommend

that a file or class name and description of purpose be included on the same "printed page" as the copyright notice for easier identification within third-party archives.

Copyright [yyyy] [name of copyright owner]

Licensed under the Apache License, Version 2.0 (the "License");

you may not use this file except in compliance with the License.

You may obtain a copy of the License at

<http://www.apache.org/licenses/LICENSE-2.0>

Unless required by applicable law or agreed to in writing, software distributed under the License is distributed on an "AS IS" BASIS, WITHOUT WARRANTIES OR CONDITIONS OF ANY KIND, either express or implied.

See the License for the specific language governing permissions and limitations under the License.

aes-src-29-04-09

This projector product includes the open source software program "aes-src-29-04-09" which applies the terms and conditions provided by owner of the copyright to the "aes-src-29-04-09".

The "aes-src-29-04-09" are WITHOUT ANY WARRANTY; without even the implied warranty of MERCHANTABILITY AND FITNESS FOR A PARTICULAR PURPOSE.

List of aes-src-29-04-09 programs

aes-src-29-04-09

License terms of conditions of each program which are provided by owner of the copyright to the "aes-src-29-04-09" are as follows.

Copyright (c) 1998-2008, Brian Gladman, Worcester, UK. All rights reserved.

#### LICENSE TERMS

The redistribution and use of this software (with or without changes) is allowed without the payment of fees or royalties provided that:

1. source code distributions include the above copyright notice, this list of conditions and the following disclaimer;
2. binary distributions include the above copyright notice, this list of conditions and the following disclaimer in their documentation;
3. the name of the copyright holder is not used to endorse products built using this software without specific written permission.

#### DISCLAIMER

This software is provided 'as is' with no explicit or implied warranties in respect of its properties, including, but not limited to, correctness and/or fitness for purpose.

newlib

This projector product includes the open source software program "newlib" which applies the terms and conditions provided by owner of the copyright to the "newlib".

The "newlib" are WITHOUT ANY WARRANTY; without even the implied warranty of MERCHANTABILITY AND FITNESS FOR A PARTICULAR PURPOSE.

List of newlib programs

newlib 1.17.0

License terms of conditions of each program which are provided by owner of the copyright to the "newlib" are as follows.

The newlib subdirectory is a collection of software from several sources.

Each file may have its own copyright/license that is embedded in the source file. Unless otherwise noted in the body of the source file(s), the following copyright notices will apply to the contents of the newlib subdirectory:

(1) Red Hat Incorporated

Copyright (c) 1994-2007 Red Hat, Inc. All rights reserved.

This copyrighted material is made available to anyone wishing to use, modify, copy, or redistribute it subject to the terms and conditions of the BSD License. This program is distributed in the hope that it will be useful, but WITHOUT ANY WARRANTY expressed or implied, including the implied warranties of MERCHANTABILITY or FITNESS FOR A PARTICULAR PURPOSE. A copy of this license is available at <http://www.opensource.org/licenses>. Any Red Hat trademarks that are incorporated in the source code or documentation are not subject to the BSD License and may only be used or replicated with the express permission of Red Hat, Inc.

(2) University of California, Berkeley

Copyright (c) 1981-2000 The Regents of the University of California.

All rights reserved.

Redistribution and use in source and binary forms, with or without modification, are permitted provided that the following conditions are met:

\* Redistributions of source code must retain the above copyright notice, this list of conditions and the following disclaimer.

\* Redistributions in binary form must reproduce the above copyright notice, this list of conditions and the following disclaimer in the documentation and/or other materials provided with the distribution.

\* Neither the name of the University nor the names of its contributors may be used to endorse or promote products derived from this software without specific prior written permission.

THIS SOFTWARE IS PROVIDED BY THE COPYRIGHT HOLDERS AND CONTRIBUTORS "AS IS" AND ANY EXPRESS OR IMPLIED WARRANTIES, INCLUDING, BUT NOT LIMITED TO, THE IMPLIED WARRANTIES OF MERCHANTABILITY AND FITNESS FOR A PARTICULAR PURPOSE ARE DISCLAIMED. IN NO EVENT SHALL THE COPYRIGHT OWNER OR CONTRIBUTORS BE LIABLE FOR ANY DIRECT, INDIRECT, INCIDENTAL, SPECIAL, EXEMPLARY, OR CONSEQUENTIAL DAMAGES (INCLUDING, BUT NOT LIMITED TO, PROCUREMENT OF SUBSTITUTE GOODS OR SERVICES; LOSS OF USE, DATA, OR PROFITS; OR BUSINESS INTERRUPTION) HOWEVER CAUSED AND ON ANY THEORY OF LIABILITY, WHETHER IN CONTRACT, STRICT LIABILITY, OR TORT (INCLUDING NEGLIGENCE OR OTHERWISE) ARISING IN ANY WAY OUT OF THE USE OF THIS SOFTWARE, EVEN IF ADVISED OF THE POSSIBILITY OF SUCH DAMAGE.

(3) David M. Gay (AT&T 1991, Lucent 1998)

The author of this software is David M. Gay.

Copyright ©) 1991 by AT&T.

Permission to use, copy, modify, and distribute this software for any purpose without fee is hereby granted, provided that this entire notice is included in all copies of any software which is or includes a copy or modification of this software and in all copies of the supporting documentation for such software.

THIS SOFTWARE IS BEING PROVIDED "AS IS", WITHOUT ANY EXPRESS OR IMPLIED WARRANTY. IN PARTICULAR, NEITHER THE AUTHOR NOR AT&T MAKES ANY REPRESENTATION OR WARRANTY OF ANY KIND CONCERNING THE MERCHANTABILITY OF THIS SOFTWARE OR ITS FITNESS FOR ANY PARTICULAR PURPOSE.

-----

The author of this software is David M. Gay.

Copyright (c) 1998-2001 by Lucent Technologies

All Rights Reserved

Permission to use, copy, modify, and distribute this software and its documentation for any purpose and without fee is hereby granted, provided that the above copyright notice appear in all copies and that both that the copyright notice and this permission notice and warranty disclaimer appear in supporting documentation, and that the name of Lucent or any of its entities not be used in advertising or publicity pertaining to distribution of the software without specific, written prior permission.

LUCENT DISCLAIMS ALL WARRANTIES WITH REGARD TO THIS SOFTWARE, INCLUDING ALL IMPLIED WARRANTIES OF MERCHANTABILITY AND FITNESS. IN NO EVENT SHALL LUCENT OR ANY OF ITS ENTITIES BE LIABLE FOR ANY SPECIAL, INDIRECT OR CONSEQUENTIAL DAMAGES OR ANY DAMAGES WHATSOEVER RESULTING FROM LOSS OF USE, DATA OR PROFITS,

WHETHER IN AN ACTION OF CONTRACT, NEGLIGENCE OR OTHER TORTIOUS ACTION,  
ARISING OUT OF OR IN CONNECTION WITH THE USE OR PERFORMANCE OF THIS SOFTWARE.

(4) Advanced Micro Devices

Copyright 1989, 1990 Advanced Micro Devices, Inc.

This software is the property of Advanced Micro Devices, Inc (AMD) which specifically grants the user the right to modify, use and distribute this software provided this notice is not removed or altered. All other rights are reserved by AMD.

AMD MAKES NO WARRANTY OF ANY KIND, EXPRESS OR IMPLIED, WITH REGARD TO THIS SOFTWARE. IN NO EVENT SHALL AMD BE LIABLE FOR INCIDENTAL OR CONSEQUENTIAL DAMAGES IN CONNECTION WITH OR ARISING FROM THE FURNISHING, PERFORMANCE, OR USE OF THIS SOFTWARE.

So that all may benefit from your experience, please report any problems or suggestions about this software to the 29K Technical Support Center at 800-29-29-AMD (800-292-9263) in the USA, or 0800-89-1131 in the UK, or 0031-11-1129 in Japan, toll free. The direct dial number is 512-462-4118.

Advanced Micro Devices, Inc.

29K Support Products

Mail Stop 573

5900 E. Ben White Blvd.

Austin, TX 78741

800-292-9263

(5) C.W. Sandmann

Copyright (C) 1993 C.W. Sandmann

This file may be freely distributed as long as the author's name remains.

(6) Eric Backus

(C) Copyright 1992 Eric Backus

This software may be used freely so long as this copyright notice is left intact. There is no warrantee on this software.

(7) Sun Microsystems

Copyright (C) 1993 by Sun Microsystems, Inc. All rights reserved.

Developed at SunPro, a Sun Microsystems, Inc. business. Permission to use, copy, modify, and distribute this software is freely granted, provided that this notice is preserved.

(8) Hewlett Packard

(c) Copyright 1986 HEWLETT-PACKARD COMPANY

To anyone who acknowledges that this file is provided "AS IS" without any express or implied warranty: permission to use, copy, modify, and distribute this file for any purpose is hereby granted without fee, provided that the above copyright notice and this notice appears in all copies, and that the name of Hewlett-Packard Company not be used in advertising or publicity pertaining to distribution of the software without specific, written prior permission. Hewlett-Packard Company makes no representations about the suitability of this software for any purpose.

(9) Hans-Peter Nilsson

Copyright (C) 2001 Hans-Peter Nilsson

Permission to use, copy, modify, and distribute this software is freely granted, provided that the above copyright notice, this notice and the following disclaimer are preserved with no changes.

THIS SOFTWARE IS PROVIDED "AS IS" AND WITHOUT ANY EXPRESS OR IMPLIED WARRANTIES, INCLUDING, WITHOUT LIMITATION, THE IMPLIED WARRANTIES OF MERCHANTABILITY AND FITNESS FOR A PARTICULAR PURPOSE.

(11) Christopher G. Demetriou

Copyright (c) 2001 Christopher G. Demetriou

All rights reserved.

Redistribution and use in source and binary forms, with or without modification, are permitted provided that the following conditions are met:

1. Redistributions of source code must retain the above copyright notice, this list of conditions and the following disclaimer.
2. Redistributions in binary form must reproduce the above copyright notice, this list of conditions and the following disclaimer in the documentation and/or other materials provided with the distribution.
3. The name of the author may not be used to endorse or promote products derived from this software without specific prior written permission.

THIS SOFTWARE IS PROVIDED BY THE AUTHOR "AS IS" AND ANY EXPRESS OR IMPLIED WARRANTIES, INCLUDING, BUT NOT LIMITED TO, THE IMPLIED WARRANTIES OF MERCHANTABILITY AND FITNESS FOR A PARTICULAR PURPOSE ARE DISCLAIMED. IN NO EVENT SHALL THE AUTHOR BE LIABLE FOR ANY DIRECT, INDIRECT, INCIDENTAL, SPECIAL, EXEMPLARY, OR CONSEQUENTIAL DAMAGES (INCLUDING, BUT NOT LIMITED TO, PROCUREMENT OF SUBSTITUTE GOODS OR SERVICES; LOSS OF USE, DATA, OR PROFITS; OR BUSINESS INTERRUPTION) HOWEVER CAUSED AND ON ANY THEORY OF LIABILITY, WHETHER IN CONTRACT, STRICT LIABILITY, OR TORT (INCLUDING NEGLIGENCE OR

OTHERWISE) ARISING IN ANY WAY OUT OF THE USE OF THIS SOFTWARE, EVEN IF ADVISED OF THE POSSIBILITY OF SUCH DAMAGE.

(12) SuperH, Inc.

Copyright 2002 SuperH, Inc. All rights reserved

This software is the property of SuperH, Inc (SuperH) which specifically grants the user the right to modify, use and distribute this software provided this notice is not removed or altered. All other rights are reserved by SuperH.

SUPERH MAKES NO WARRANTY OF ANY KIND, EXPRESS OR IMPLIED, WITH REGARD TO THIS SOFTWARE. IN NO EVENT SHALL SUPERH BE LIABLE FOR INDIRECT, SPECIAL, INCIDENTAL OR CONSEQUENTIAL DAMAGES IN CONNECTION WITH OR ARISING FROM THE FURNISHING, PERFORMANCE, OR USE OF THIS SOFTWARE.

So that all may benefit from your experience, please report any problems or suggestions about this software to the SuperH Support Center via e-mail at [softwaresupport@superh.com](mailto:softwaresupport@superh.com) .

SuperH, Inc.

405 River Oaks Parkway

San Jose

CA 95134

USA

(13) Royal Institute of Technology

Copyright (c) 1999 Kungliga Tekniska Hökolan (Royal Institute of Technology, Stockholm, Sweden).

All rights reserved.

Redistribution and use in source and binary forms, with or without modification, are permitted provided that the following conditions are met:

1. Redistributions of source code must retain the above copyright notice, this list of conditions and the following disclaimer.
2. Redistributions in binary form must reproduce the above copyright notice, this list of conditions and the following disclaimer in the documentation and/or other materials provided with the distribution.
3. Neither the name of KTH nor the names of its contributors may be used to endorse or promote products derived from this software without specific prior written permission.

THIS SOFTWARE IS PROVIDED BY KTH AND ITS CONTRIBUTORS "AS IS" AND ANY EXPRESS OR IMPLIED WARRANTIES, INCLUDING, BUT NOT LIMITED TO, THE IMPLIED WARRANTIES OF

MERCHANTABILITY AND FITNESS FOR A PARTICULAR PURPOSE ARE DISCLAIMED. IN NO EVENT SHALL KTH OR ITS CONTRIBUTORS BE LIABLE FOR ANY DIRECT, INDIRECT, INCIDENTAL, SPECIAL, EXEMPLARY, OR CONSEQUENTIAL DAMAGES (INCLUDING, BUT NOT LIMITED TO, PROCUREMENT OF SUBSTITUTE GOODS OR SERVICES; LOSS OF USE, DATA, OR PROFITS; OR BUSINESS INTERRUPTION) HOWEVER CAUSED AND ON ANY THEORY OF LIABILITY, WHETHER IN CONTRACT, STRICT LIABILITY, OR TORT (INCLUDING NEGLIGENCE OR OTHERWISE) ARISING IN ANY WAY OUT OF THE USE OF THIS SOFTWARE, EVEN IF ADVISED OF THE POSSIBILITY OF SUCH DAMAGE.

(14) Alexey Zelkin

Copyright (c) 2000, 2001 Alexey Zelkin <phantom@FreeBSD.org>

All rights reserved.

Redistribution and use in source and binary forms, with or without modification, are permitted provided that the following conditions are met:

1. Redistributions of source code must retain the above copyright notice, this list of conditions and the following disclaimer.
2. Redistributions in binary form must reproduce the above copyright notice, this list of conditions and the following disclaimer in the documentation and/or other materials provided with the distribution.

THIS SOFTWARE IS PROVIDED BY THE AUTHOR AND CONTRIBUTORS "AS IS" AND ANY EXPRESS OR IMPLIED WARRANTIES, INCLUDING, BUT NOT LIMITED TO, THE IMPLIED WARRANTIES OF MERCHANTABILITY AND FITNESS FOR A PARTICULAR PURPOSE ARE DISCLAIMED. IN NO EVENT SHALL THE AUTHOR OR CONTRIBUTORS BE LIABLE FOR ANY DIRECT, INDIRECT, INCIDENTAL, SPECIAL, EXEMPLARY, OR CONSEQUENTIAL DAMAGES (INCLUDING, BUT NOT LIMITED TO, PROCUREMENT OF SUBSTITUTE GOODS OR SERVICES; LOSS OF USE, DATA, OR PROFITS; OR BUSINESS INTERRUPTION) HOWEVER CAUSED AND ON ANY THEORY OF LIABILITY, WHETHER IN CONTRACT, STRICT LIABILITY, OR TORT (INCLUDING NEGLIGENCE OR OTHERWISE) ARISING IN ANY WAY OUT OF THE USE OF THIS SOFTWARE, EVEN IF ADVISED OF THE POSSIBILITY OF SUCH DAMAGE.

(15) Andrey A. Chernov

Copyright (C) 1997 by Andrey A. Chernov, Moscow, Russia.

All rights reserved.

Redistribution and use in source and binary forms, with or without modification, are permitted provided that the following conditions are met:

1. Redistributions of source code must retain the above copyright notice, this list of conditions and the following disclaimer.



2. Redistributions in binary form must reproduce the above copyright notice, this list of conditions and the following disclaimer in the documentation and/or other materials provided with the distribution.

THIS SOFTWARE IS PROVIDED BY THE AUTHOR "AS IS" AND ANY EXPRESS OR IMPLIED WARRANTIES, INCLUDING, BUT NOT LIMITED TO, THE IMPLIED WARRANTIES OF MERCHANTABILITY AND FITNESS FOR A PARTICULAR PURPOSE ARE DISCLAIMED. IN NO EVENT SHALL THE REGENTS OR CONTRIBUTORS BE LIABLE FOR ANY DIRECT, INDIRECT, INCIDENTAL, SPECIAL, EXEMPLARY, OR CONSEQUENTIAL DAMAGES (INCLUDING, BUT NOT LIMITED TO, PROCUREMENT OF SUBSTITUTE GOODS OR SERVICES; LOSS OF USE, DATA, OR PROFITS; OR BUSINESS INTERRUPTION) HOWEVER CAUSED AND ON ANY THEORY OF LIABILITY, WHETHER IN CONTRACT, STRICT LIABILITY, OR TORT (INCLUDING NEGLIGENCE OR OTHERWISE) ARISING IN ANY WAY OUT OF THE USE OF THIS SOFTWARE, EVEN IF ADVISED OF THE POSSIBILITY OF SUCH DAMAGE.

(16) FreeBSD

Copyright (c) 1997-2002 FreeBSD Project.

All rights reserved.

Redistribution and use in source and binary forms, with or without modification, are permitted provided that the following conditions are met:

1. Redistributions of source code must retain the above copyright notice, this list of conditions and the following disclaimer.

2. Redistributions in binary form must reproduce the above copyright notice, this list of conditions and the following disclaimer in the documentation and/or other materials provided with the distribution.

THIS SOFTWARE IS PROVIDED BY THE AUTHOR AND CONTRIBUTORS "AS IS" AND ANY EXPRESS OR IMPLIED WARRANTIES, INCLUDING, BUT NOT LIMITED TO, THE IMPLIED WARRANTIES OF MERCHANTABILITY AND FITNESS FOR A PARTICULAR PURPOSE ARE DISCLAIMED. IN NO EVENT SHALL THE AUTHOR OR CONTRIBUTORS BE LIABLE FOR ANY DIRECT, INDIRECT, INCIDENTAL, SPECIAL, EXEMPLARY, OR CONSEQUENTIAL DAMAGES (INCLUDING, BUT NOT LIMITED TO, PROCUREMENT OF SUBSTITUTE GOODS OR SERVICES; LOSS OF USE, DATA, OR PROFITS; OR BUSINESS INTERRUPTION) HOWEVER CAUSED AND ON ANY THEORY OF LIABILITY, WHETHER IN CONTRACT, STRICT LIABILITY, OR TORT (INCLUDING NEGLIGENCE OR OTHERWISE) ARISING IN ANY WAY OUT OF THE USE OF THIS SOFTWARE, EVEN IF ADVISED OF THE POSSIBILITY OF SUCH DAMAGE.

(17) S. L. Moshier

Author: S. L. Moshier.

Copyright (c) 1984,2000 S.L. Moshier

Permission to use, copy, modify, and distribute this software for any purpose without fee is hereby granted, provided that this entire notice is included in all copies of any software which is or includes a copy or modification of this software and in all copies of the supporting documentation for such software.

THIS SOFTWARE IS BEING PROVIDED "AS IS", WITHOUT ANY EXPRESS OR IMPLIED WARRANTY. IN PARTICULAR, THE AUTHOR MAKES NO REPRESENTATION OR WARRANTY OF ANY KIND CONCERNING THE MERCHANTABILITY OF THIS SOFTWARE OR ITS FITNESS FOR ANY PARTICULAR PURPOSE.

(18) Citrus Project

Copyright (c)1999 Citrus Project,

All rights reserved.

Redistribution and use in source and binary forms, with or without modification, are permitted provided that the following conditions are met:

1. Redistributions of source code must retain the above copyright notice, this list of conditions and the following disclaimer.
2. Redistributions in binary form must reproduce the above copyright notice, this list of conditions and the following disclaimer in the documentation and/or other materials provided with the distribution.

THIS SOFTWARE IS PROVIDED BY THE AUTHOR AND CONTRIBUTORS "AS IS" AND ANY EXPRESS OR IMPLIED WARRANTIES, INCLUDING, BUT NOT LIMITED TO, THE IMPLIED WARRANTIES OF MERCHANTABILITY AND FITNESS FOR A PARTICULAR PURPOSE ARE DISCLAIMED. IN NO EVENT SHALL THE AUTHOR OR CONTRIBUTORS BE LIABLE FOR ANY DIRECT, INDIRECT, INCIDENTAL, SPECIAL, EXEMPLARY, OR CONSEQUENTIAL DAMAGES (INCLUDING, BUT NOT LIMITED TO, PROCUREMENT OF SUBSTITUTE GOODS OR SERVICES; LOSS OF USE, DATA, OR PROFITS; OR BUSINESS INTERRUPTION) HOWEVER CAUSED AND ON ANY THEORY OF LIABILITY, WHETHER IN CONTRACT, STRICT LIABILITY, OR TORT (INCLUDING NEGLIGENCE OR OTHERWISE) ARISING IN ANY WAY OUT OF THE USE OF THIS SOFTWARE, EVEN IF ADVISED OF THE POSSIBILITY OF SUCH DAMAGE.

(19) Todd C. Miller

Copyright (c) 1998 Todd C. Miller <Todd.Miller@courtesan.com>

All rights reserved.

Redistribution and use in source and binary forms, with or without modification, are permitted provided that the following conditions are met:

1. Redistributions of source code must retain the above copyright notice, this list of conditions and the following disclaimer.

2. Redistributions in binary form must reproduce the above copyright notice, this list of conditions and the following disclaimer in the documentation and/or other materials provided with the distribution.

3. The name of the author may not be used to endorse or promote products derived from this software without specific prior written permission.

THIS SOFTWARE IS PROVIDED "AS IS" AND ANY EXPRESS OR IMPLIED WARRANTIES, INCLUDING, BUT NOT LIMITED TO, THE IMPLIED WARRANTIES OF MERCHANTABILITY AND FITNESS FOR A PARTICULAR PURPOSE ARE DISCLAIMED. IN NO EVENT SHALL THE AUTHOR BE LIABLE FOR ANY DIRECT, INDIRECT, INCIDENTAL, SPECIAL, EXEMPLARY, OR CONSEQUENTIAL DAMAGES (INCLUDING, BUT NOT LIMITED TO, PROCUREMENT OF SUBSTITUTE GOODS OR SERVICES; LOSS OF USE, DATA, OR PROFITS; OR BUSINESS INTERRUPTION) HOWEVER CAUSED AND ON ANY THEORY OF LIABILITY, WHETHER IN CONTRACT, STRICT LIABILITY, OR TORT (INCLUDING NEGLIGENCE OR OTHERWISE) ARISING IN ANY WAY OUT OF THE USE OF THIS SOFTWARE, EVEN IF ADVISED OF THE POSSIBILITY OF SUCH DAMAGE.

(20) DJ Delorie (i386)

Copyright (C) 1991 DJ Delorie

All rights reserved.

Redistribution and use in source and binary forms is permitted provided that the above copyright notice and following paragraph are duplicated in all such forms.

This file is distributed WITHOUT ANY WARRANTY; without even the implied warranty of MERCHANTABILITY or FITNESS FOR A PARTICULAR PURPOSE.

(23) Intel (i960)

Copyright (c) 1993 Intel Corporation

Intel hereby grants you permission to copy, modify, and distribute this software and its documentation. Intel grants this permission provided that the above copyright notice appears in all copies and that both the copyright notice and this permission notice appear in supporting documentation. In addition, Intel grants this permission provided that you prominently mark as "not part of the original" any modifications made to this software or documentation, and that the name of Intel Corporation not be used in advertising or publicity pertaining to distribution of the software or the documentation without specific, written prior permission.

Intel Corporation provides this AS IS, WITHOUT ANY WARRANTY, EXPRESS OR IMPLIED, INCLUDING, WITHOUT LIMITATION, ANY WARRANTY OF MERCHANTABILITY OR FITNESS FOR A PARTICULAR PURPOSE. Intel makes no guarantee or representations regarding the use of, or the results of the use of, the software and documentation in terms of correctness, accuracy, reliability, currentness, or otherwise; and you rely on the software, documentation and results solely at your own risk.

IN NO EVENT SHALL INTEL BE LIABLE FOR ANY LOSS OF USE, LOSS OF BUSINESS, LOSS OF PROFITS, INDIRECT, INCIDENTAL, SPECIAL OR CONSEQUENTIAL DAMAGES OF ANY KIND. IN NO EVENT SHALL INTEL'S TOTAL LIABILITY EXCEED THE SUM PAID TO INTEL FOR THE PRODUCT LICENSED HEREUNDER.

(26) Mike Barcroft

Copyright (c) 2001 Mike Barcroft <mike@FreeBSD.org>

All rights reserved.

Redistribution and use in source and binary forms, with or without modification, are permitted provided that the following conditions are met:

1. Redistributions of source code must retain the above copyright notice, this list of conditions and the following disclaimer.
2. Redistributions in binary form must reproduce the above copyright notice, this list of conditions and the following disclaimer in the documentation and/or other materials provided with the distribution.

THIS SOFTWARE IS PROVIDED BY THE AUTHOR AND CONTRIBUTORS "AS IS" AND ANY EXPRESS OR IMPLIED WARRANTIES, INCLUDING, BUT NOT LIMITED TO, THE IMPLIED WARRANTIES OF MERCHANTABILITY AND FITNESS FOR A PARTICULAR PURPOSE ARE DISCLAIMED. IN NO EVENT SHALL THE AUTHOR OR CONTRIBUTORS BE LIABLE FOR ANY DIRECT, INDIRECT, INCIDENTAL, SPECIAL, EXEMPLARY, OR CONSEQUENTIAL DAMAGES (INCLUDING, BUT NOT LIMITED TO, PROCUREMENT OF SUBSTITUTE GOODS OR SERVICES; LOSS OF USE, DATA, OR PROFITS; OR BUSINESS INTERRUPTION) HOWEVER CAUSED AND ON ANY THEORY OF LIABILITY, WHETHER IN CONTRACT, STRICT LIABILITY, OR TORT (INCLUDING NEGLIGENCE OR OTHERWISE) ARISING IN ANY WAY OUT OF THE USE OF THIS SOFTWARE, EVEN IF ADVISED OF THE POSSIBILITY OF SUCH DAMAGE.

(27) Konstantin Chuguev (--enable-newlib-iconv)

Copyright (c) 1999, 2000

Konstantin Chuguev. All rights reserved.

Redistribution and use in source and binary forms, with or without modification, are permitted provided that the following conditions are met:

1. Redistributions of source code must retain the above copyright notice, this list of conditions and the following disclaimer.
2. Redistributions in binary form must reproduce the above copyright notice, this list of conditions and the following disclaimer in the documentation and/or other materials provided with the distribution.

THIS SOFTWARE IS PROVIDED BY THE AUTHOR AND CONTRIBUTORS "AS IS" AND ANY EXPRESS OR IMPLIED WARRANTIES, INCLUDING, BUT NOT LIMITED TO, THE IMPLIED

WARRANTIES OF MERCHANTABILITY AND FITNESS FOR A PARTICULAR PURPOSE ARE DISCLAIMED. IN NO EVENT SHALL THE AUTHOR OR CONTRIBUTORS BE LIABLE FOR ANY DIRECT, INDIRECT, INCIDENTAL, SPECIAL, EXEMPLARY, OR CONSEQUENTIAL DAMAGES (INCLUDING, BUT NOT LIMITED TO, PROCUREMENT OF SUBSTITUTE GOODS OR SERVICES; LOSS OF USE, DATA, OR PROFITS; OR BUSINESS INTERRUPTION) HOWEVER CAUSED AND ON ANY THEORY OF LIABILITY, WHETHER IN CONTRACT, STRICT LIABILITY, OR TORT (INCLUDING NEGLIGENCE OR OTHERWISE) ARISING IN ANY WAY OUT OF THE USE OF THIS SOFTWARE, EVEN IF ADVISED OF THE POSSIBILITY OF SUCH DAMAGE.

iconv (Charset Conversion Library) v2.0

(28) Artem Bityuckiy (--enable-newlib-iconv)

Copyright (c) 2003, Artem B. Bityuckiy, SoftMine Corporation. Rights transferred to Franklin Electronic Publishers.

Redistribution and use in source and binary forms, with or without modification, are permitted provided that the following conditions are met:

1. Redistributions of source code must retain the above copyright notice, this list of conditions and the following disclaimer.
2. Redistributions in binary form must reproduce the above copyright notice, this list of conditions and the following disclaimer in the documentation and/or other materials provided with the distribution.

THIS SOFTWARE IS PROVIDED BY THE AUTHOR AND CONTRIBUTORS "AS IS" AND ANY EXPRESS OR IMPLIED WARRANTIES, INCLUDING, BUT NOT LIMITED TO, THE IMPLIED WARRANTIES OF MERCHANTABILITY AND FITNESS FOR A PARTICULAR PURPOSE ARE DISCLAIMED. IN NO EVENT SHALL THE AUTHOR OR CONTRIBUTORS BE LIABLE FOR ANY DIRECT, INDIRECT, INCIDENTAL, SPECIAL, EXEMPLARY, OR CONSEQUENTIAL DAMAGES (INCLUDING, BUT NOT LIMITED TO, PROCUREMENT OF SUBSTITUTE GOODS OR SERVICES; LOSS OF USE, DATA, OR PROFITS; OR BUSINESS INTERRUPTION) HOWEVER CAUSED AND ON ANY THEORY OF LIABILITY, WHETHER IN CONTRACT, STRICT LIABILITY, OR TORT (INCLUDING NEGLIGENCE OR OTHERWISE) ARISING IN ANY WAY OUT OF THE USE OF THIS SOFTWARE, EVEN IF ADVISED OF THE POSSIBILITY OF SUCH DAMAGE.

(30) - Alex Tatmanjants (targets using libc/posix)

Copyright (c) 1995 Alex Tatmanjants <alex@elvisti.kiev.ua>

at Electronni Visti IA, Kiev, Ukraine.

All rights reserved.

Redistribution and use in source and binary forms, with or without modification, are permitted provided that the following conditions are met:

1. Redistributions of source code must retain the above copyright notice, this list of conditions and the following disclaimer.

2. Redistributions in binary form must reproduce the above copyright notice, this list of conditions and the following disclaimer in the documentation and/or other materials provided with the distribution.

THIS SOFTWARE IS PROVIDED BY THE AUTHOR "AS IS" AND ANY EXPRESS OR IMPLIED WARRANTIES, INCLUDING, BUT NOT LIMITED TO, THE IMPLIED WARRANTIES OF MERCHANTABILITY AND FITNESS FOR A PARTICULAR PURPOSE ARE DISCLAIMED. IN NO EVENT SHALL THE AUTHOR BE LIABLE FOR ANY DIRECT, INDIRECT, INCIDENTAL, SPECIAL, EXEMPLARY, OR CONSEQUENTIAL DAMAGES (INCLUDING, BUT NOT LIMITED TO, PROCUREMENT OF SUBSTITUTE GOODS OR SERVICES; LOSS OF USE, DATA, OR PROFITS; OR BUSINESS INTERRUPTION) HOWEVER CAUSED AND ON ANY THEORY OF LIABILITY, WHETHER IN CONTRACT, STRICT LIABILITY, OR TORT (INCLUDING NEGLIGENCE OR OTHERWISE) ARISING IN ANY WAY OUT OF THE USE OF THIS SOFTWARE, EVEN IF ADVISED OF THE POSSIBILITY OF SUCH DAMAGE.

(31) - M. Warner Losh (targets using libc/posix)

Copyright (c) 1998, M. Warner Losh <imp@freebsd.org>

All rights reserved.

Redistribution and use in source and binary forms, with or without modification, are permitted provided that the following conditions are met:

1. Redistributions of source code must retain the above copyright notice, this list of conditions and the following disclaimer.

2. Redistributions in binary form must reproduce the above copyright notice, this list of conditions and the following disclaimer in the documentation and/or other materials provided with the distribution.

THIS SOFTWARE IS PROVIDED BY THE AUTHOR AND CONTRIBUTORS "AS IS" AND ANY EXPRESS OR IMPLIED WARRANTIES, INCLUDING, BUT NOT LIMITED TO, THE IMPLIED WARRANTIES OF MERCHANTABILITY AND FITNESS FOR A PARTICULAR PURPOSE ARE DISCLAIMED. IN NO EVENT SHALL THE AUTHOR OR CONTRIBUTORS BE LIABLE FOR ANY DIRECT, INDIRECT, INCIDENTAL, SPECIAL, EXEMPLARY, OR CONSEQUENTIAL DAMAGES (INCLUDING, BUT NOT LIMITED TO, PROCUREMENT OF SUBSTITUTE GOODS OR SERVICES; LOSS OF USE, DATA, OR PROFITS; OR BUSINESS INTERRUPTION) HOWEVER CAUSED AND ON ANY THEORY OF LIABILITY, WHETHER IN CONTRACT, STRICT LIABILITY, OR TORT (INCLUDING NEGLIGENCE OR OTHERWISE) ARISING IN ANY WAY OUT OF THE USE OF THIS SOFTWARE, EVEN IF ADVISED OF THE POSSIBILITY OF SUCH DAMAGE.

(32) - Andrey A. Chernov (targets using libc/posix)

Copyright (C) 1996 by Andrey A. Chernov, Moscow, Russia.

All rights reserved.

Redistribution and use in source and binary forms, with or without modification, are permitted provided that the following conditions are met:

1. Redistributions of source code must retain the above copyright notice, this list of conditions and the following disclaimer.
2. Redistributions in binary form must reproduce the above copyright notice, this list of conditions and the following disclaimer in the documentation and/or other materials provided with the distribution.

THIS SOFTWARE IS PROVIDED BY THE AUTHOR "AS IS" AND ANY EXPRESS OR IMPLIED WARRANTIES, INCLUDING, BUT NOT LIMITED TO, THE IMPLIED WARRANTIES OF MERCHANTABILITY AND FITNESS FOR A PARTICULAR PURPOSE ARE DISCLAIMED. IN NO EVENT SHALL THE REGENTS OR CONTRIBUTORS BE LIABLE FOR ANY DIRECT, INDIRECT, INCIDENTAL, SPECIAL, EXEMPLARY, OR CONSEQUENTIAL DAMAGES (INCLUDING, BUT NOT LIMITED TO, PROCUREMENT OF SUBSTITUTE GOODS OR SERVICES; LOSS OF USE, DATA, OR PROFITS; OR BUSINESS INTERRUPTION) HOWEVER CAUSED AND ON ANY THEORY OF LIABILITY, WHETHER IN CONTRACT, STRICT LIABILITY, OR TORT (INCLUDING NEGLIGENCE OR OTHERWISE) ARISING IN ANY WAY OUT OF THE USE OF THIS SOFTWARE, EVEN IF ADVISED OF THE POSSIBILITY OF SUCH DAMAGE.

(33) - Daniel Eischen (targets using libc/posix)

Copyright (c) 2001 Daniel Eischen <deischen@FreeBSD.org>.

All rights reserved.

Redistribution and use in source and binary forms, with or without modification, are permitted provided that the following conditions are met:

1. Redistributions of source code must retain the above copyright notice, this list of conditions and the following disclaimer.
2. Redistributions in binary form must reproduce the above copyright notice, this list of conditions and the following disclaimer in the documentation and/or other materials provided with the distribution.

THIS SOFTWARE IS PROVIDED BY THE AUTHOR AND CONTRIBUTORS "AS IS" AND ANY EXPRESS OR IMPLIED WARRANTIES, INCLUDING, BUT NOT LIMITED TO, THE IMPLIED WARRANTIES OF MERCHANTABILITY AND FITNESS FOR A PARTICULAR PURPOSE ARE DISCLAIMED. IN NO EVENT SHALL THE REGENTS OR CONTRIBUTORS BE LIABLE FOR ANY DIRECT, INDIRECT, INCIDENTAL, SPECIAL, EXEMPLARY, OR CONSEQUENTIAL DAMAGES (INCLUDING, BUT NOT LIMITED TO, PROCUREMENT OF SUBSTITUTE GOODS OR SERVICES; LOSS OF USE, DATA, OR PROFITS; OR BUSINESS INTERRUPTION) HOWEVER CAUSED AND ON ANY THEORY OF LIABILITY, WHETHER IN CONTRACT, STRICT LIABILITY, OR TORT (INCLUDING NEGLIGENCE OR OTHERWISE) ARISING IN ANY WAY OUT OF THE USE OF THIS SOFTWARE, EVEN IF ADVISED OF THE POSSIBILITY OF SUCH DAMAGE.

(35) - ARM Ltd (arm and thumb variant targets only)

Copyright (c) 2009 ARM Ltd

All rights reserved.

Redistribution and use in source and binary forms, with or without modification, are permitted provided that the following conditions are met:

1. Redistributions of source code must retain the above copyright notice, this list of conditions and the following disclaimer.
2. Redistributions in binary form must reproduce the above copyright notice, this list of conditions and the following disclaimer in the documentation and/or other materials provided with the distribution.
3. The name of the company may not be used to endorse or promote products derived from this software without specific prior written permission.

THIS SOFTWARE IS PROVIDED BY ARM LTD "AS IS" AND ANY EXPRESS OR IMPLIED WARRANTIES, INCLUDING, BUT NOT LIMITED TO, THE IMPLIED WARRANTIES OF MERCHANTABILITY AND FITNESS FOR A PARTICULAR PURPOSE ARE DISCLAIMED. IN NO EVENT SHALL ARM LTD BE LIABLE FOR ANY DIRECT, INDIRECT, INCIDENTAL, SPECIAL, EXEMPLARY, OR CONSEQUENTIAL DAMAGES (INCLUDING, BUT NOT LIMITED TO, PROCUREMENT OF SUBSTITUTE GOODS OR SERVICES; LOSS OF USE, DATA, OR PROFITS; OR BUSINESS INTERRUPTION) HOWEVER CAUSED AND ON ANY THEORY OF LIABILITY, WHETHER IN CONTRACT, STRICT LIABILITY, OR TORT (INCLUDING NEGLIGENCE OR OTHERWISE) ARISING IN ANY WAY OUT OF THE USE OF THIS SOFTWARE, EVEN IF ADVISED OF THE POSSIBILITY OF SUCH DAMAGE.

(36) - CodeSourcery, Inc.

Copyright (c) 2009 CodeSourcery, Inc.

All rights reserved.

Redistribution and use in source and binary forms, with or without modification, are permitted provided that the following conditions are met:

- \* Redistributions of source code must retain the above copyright notice, this list of conditions and the following disclaimer.
- \* Redistributions in binary form must reproduce the above copyright notice, this list of conditions and the following disclaimer in the documentation and/or other materials provided with the distribution.
- \* Neither the name of CodeSourcery nor the names of its contributors may be used to endorse or promote products derived from this software without specific prior written permission.

THIS SOFTWARE IS PROVIDED BY CODESOURCERY, INC. "AS IS" AND ANY EXPRESS OR IMPLIED WARRANTIES, INCLUDING, BUT NOT LIMITED TO, THE IMPLIED WARRANTIES OF



MERCHANTABILITY AND FITNESS FOR A PARTICULAR PURPOSE ARE DISCLAIMED. IN NO EVENT SHALL CODESOURCERY BE LIABLE FOR ANY DIRECT, INDIRECT, INCIDENTAL, SPECIAL, EXEMPLARY, OR CONSEQUENTIAL DAMAGES (INCLUDING, BUT NOT LIMITED TO, PROCUREMENT OF SUBSTITUTE GOODS OR SERVICES; LOSS OF USE, DATA, OR PROFITS; OR BUSINESS INTERRUPTION) HOWEVER CAUSED AND ON ANY THEORY OF LIABILITY, WHETHER IN CONTRACT, STRICT LIABILITY, OR TORT (INCLUDING NEGLIGENCE OR OTHERWISE) ARISING IN ANY WAY OUT OF THE USE OF THIS SOFTWARE, EVEN IF ADVISED OF THE POSSIBILITY OF SUCH DAMAGE.

(37) MIPS Technologies, Inc

/\*

\* Copyright (c) 2009 MIPS Technologies, Inc.

\*

\* All rights reserved.

\*

\* Redistribution and use in source and binary forms, with or without modification, are permitted provided that the following conditions are met:

\*

\* \* Redistributions of source code must retain the above copyright notice, this list of conditions and the following disclaimer.

\* \* Redistributions in binary form must reproduce the above copyright notice, this list of conditions and the following disclaimer in the documentation and/or other materials provided with the distribution.

\* \* Neither the name of MIPS Technologies Inc. nor the names of its contributors may be used to endorse or promote products derived from this software without specific prior written permission.

\* THIS SOFTWARE IS PROVIDED BY THE COPYRIGHT HOLDERS AND CONTRIBUTORS "AS IS" AND ANY EXPRESS OR IMPLIED WARRANTIES, INCLUDING, BUT NOT LIMITED TO, THE IMPLIED WARRANTIES OF MERCHANTABILITY AND FITNESS FOR A PARTICULAR PURPOSE ARE DISCLAIMED. IN NO EVENT SHALL THE COPYRIGHT OWNER OR CONTRIBUTORS BE LIABLE FOR ANY DIRECT, INDIRECT, INCIDENTAL, SPECIAL, EXEMPLARY, OR CONSEQUENTIAL DAMAGES (INCLUDING, BUT NOT LIMITED TO, PROCUREMENT OF SUBSTITUTE GOODS OR SERVICES; LOSS OF USE, DATA, OR PROFITS; OR BUSINESS INTERRUPTION) HOWEVER CAUSED AND ON ANY THEORY OF LIABILITY, WHETHER IN CONTRACT, STRICT LIABILITY, OR TORT (INCLUDING NEGLIGENCE OR OTHERWISE) ARISING IN ANY WAY OUT OF THE USE OF THIS SOFTWARE, EVEN IF ADVISED OF THE POSSIBILITY OF SUCH DAMAGE.

/\*

## MIT License

This projector product includes the open source software program which applies the terms and conditions provided by owner of the copyright to the "MIT License". The "MIT License" are WITHOUT ANY WARRANTY; without even the implied warranty of MERCHANTABILITY AND FITNESS FOR A PARTICULAR PURPOSE.

### List of MIT License programs

jquery-1.7.2.min.js

jquery-ui-1.8.20.custom.zip

jquery.ui.touch-punch.js

jquery.upload-1.0.2.min.js

License terms of conditions of each program which are provided by owner of the copyright to the "MIT License" are as follows.

Permission is hereby granted, free of charge, to any person obtaining a copy of this software and associated documentation files (the "Software"), to deal in the Software without restriction, including without limitation the rights to use, copy, modify, merge, publish, distribute, sublicense, and/or sell copies of the Software, and to permit persons to whom the Software is furnished to do so, subject to the following conditions:

The above copyright notice and this permission notice shall be included in all copies or substantial portions of the Software.

THE SOFTWARE IS PROVIDED "AS IS", WITHOUT WARRANTY OF ANY KIND, EXPRESS OR IMPLIED, INCLUDING BUT NOT LIMITED TO THE WARRANTIES OF MERCHANTABILITY, FITNESS FOR A PARTICULAR PURPOSE AND NONINFRINGEMENT. IN NO EVENT SHALL THE AUTHORS OR COPYRIGHT HOLDERS BE LIABLE FOR ANY CLAIM, DAMAGES OR OTHER LIABILITY, WHETHER IN AN ACTION OF CONTRACT, TORT OR OTHERWISE, ARISING FROM, OUT OF OR IN CONNECTION WITH THE SOFTWARE OR THE USE OR OTHER DEALINGS IN THE SOFTWARE.

### TOPPERS/JSP

This projector product includes the open source software program "TOPPERS/JSP" which applies the terms and conditions provided by owner of the copyright to the "TOPPERS/JSP". The "TOPPERS/JSP" are WITHOUT ANY WARRANTY; without even the implied warranty of MERCHANTABILITY AND FITNESS FOR A PARTICULAR PURPOSE.

### List of TOPPERS/JSP programs

jsp-1.4.3

License terms of conditions of each program which are provided by owner of the copyright to the "TOPPERS/JSP" are as follows.

TOPPERS/JSP Kernel

Toyohashi Open Platform for Embedded Real-Time Systems/Just Standard Profile Kernel

Copyright (C) 2000-2003 by Embedded and Real-Time Systems Laboratory Toyohashi Univ. of Technology, JAPAN

Copyright (C) 2004 by Embedded and Real-Time Systems Laboratory

Graduate School of Information Science, Nagoya Univ., JAPAN.

The above copyright holder, limited to cases in which one satisfies conditions (1) ~ (4) below, or the conditions described in Version 2 of the GNU Public License officially announced by the Free Software Foundation, consents to the use, reproduction, alteration, and redistribution (hereafter called utilization) of this software (this software includes alterations, likewise below) without compensation.

(1) When this software is utilized in the form of source code, the above copyright declaration, these conditions of utilization, and the following stipulation of no guarantee shall be included in unchanged form inside the source code.

(2) When this software is redistributed in a form in which it can be used in the development of other software, library form, etc., the above copyright display, these terms of utilization, and the following stipulation of no guarantee shall be inserted in documentation accompanying redistribution (user's manual, etc.).

(3) When this software is redistributed in a form in which it cannot be used in the development of other software, embedded in devices, etc., one of the following conditions shall be satisfied.

(a) The above copyright display, these terms of utilization, and the following stipulation of no guarantee shall be inserted in documentation accompanying redistribution (user's manual, etc.).

(b) The TOPPERS Project shall be notified owing to a method in which the form of distribution is decided otherwise.

(4) The above copyright holder and the TOPPERS Project shall be exempt from responsibility for whatever damages occur either directly or indirectly through the utilization of this software.

This software is something that is provided with no guarantee. The above copyright holder and the TOPPERS Project make no guarantee whatsoever in regard to this software, including the possibility of its application. In addition, the above copyright holder and the TOPPERS Project shall also not bear responsibility for whatever damages occur either directly or indirectly through the utilization of this software.

Note: The TOPPERS License has been revised several times; what is shown above is the latest version that is to be applied to software made public hereafter.

TINET

This projector product includes the open source software program "TINET" which applies the terms and conditions provided by owner of the copyright to the "TINET". The "TINET" are WITHOUT ANY WARRANTY; without even the implied warranty of MERCHANTABILITY AND FITNESS FOR A PARTICULAR PURPOSE.

List of TINET programs

tinnet-1.4.4

License terms of conditions of each program which are provided by owner of the copyright to the "TINET" are as follows.

(1) FreeBSD

Copyright (c) 1980, 1986, 1993

The Regents of the University of California. All rights reserved.

Redistribution and use in source and binary forms, with or without modification, are permitted provided that the following conditions are met:

1. Redistributions of source code must retain the above copyright notice, this list of conditions and the following disclaimer.
2. Redistributions in binary form must reproduce the above copyright notice, this list of conditions and the following disclaimer in the documentation and/or other materials provided with the distribution.
3. All advertising materials mentioning features or use of this software must display the following acknowledgement:

This product includes software developed by the University of California, Berkeley and its contributors.

4. Neither the name of the University nor the names of its contributors may be used to endorse or promote products derived from this software without specific prior written permission.

THIS SOFTWARE IS PROVIDED BY THE REGENTS AND CONTRIBUTORS "AS IS" AND ANY EXPRESS OR IMPLIED WARRANTIES, INCLUDING, BUT NOT LIMITED TO, THE IMPLIED WARRANTIES OF MERCHANTABILITY AND FITNESS FOR A PARTICULAR PURPOSE ARE DISCLAIMED. IN NO EVENT SHALL THE REGENTS OR CONTRIBUTORS BE LIABLE FOR ANY DIRECT, INDIRECT, INCIDENTAL, SPECIAL, EXEMPLARY, OR CONSEQUENTIAL DAMAGES (INCLUDING, BUT NOT LIMITED TO, PROCUREMENT OF SUBSTITUTE GOODS OR SERVICES; LOSS OF USE, DATA, OR PROFITS; OR BUSINESS INTERRUPTION) HOWEVER CAUSED AND ON ANY THEORY OF LIABILITY, WHETHER IN CONTRACT, STRICT LIABILITY, OR TORT (INCLUDING NEGLIGENCE OR OTHERWISE) ARISING IN ANY WAY OUT OF THE USE OF THIS SOFTWARE, EVEN IF ADVISED OF THE POSSIBILITY OF SUCH DAMAGE.

(6) TINET and TOPPERS

TINET (TCP/IP Protocol Stack)

Copyright (C) 2001-2006 by Dep. of Computer Science and Engineering Tomakomai National College of Technology, JAPAN

TINET (TCP/IP Protocol Stack)

Copyright (C) 2001-2006 by Dep. of Computer Science and Engineering Tomakomai National College of Technology, JAPAN

The above copyright holder, limited to cases in which one satisfies conditions (1) ~ (4) below, or the conditions described in Version 2 of the GNU Public License officially announced by the Free Software Foundation, consents to the use, reproduction, alteration, and redistribution (hereafter called utilization) of this software (this software includes alterations, likewise below) without compensation.

(1) When this software is utilized in the form of source code, the above copyright declaration, these conditions of utilization, and the following stipulation of no guarantee shall be included in unchanged form inside the source code.

(2) When this software is redistributed in a form in which it can be used in the development of other software, library form, etc., the above copyright display, these terms of utilization, and the following stipulation of no guarantee shall be inserted in documentation accompanying redistribution (user's manual, etc.).

(3) When this software is redistributed in a form in which it cannot be used in the development of other software, embedded in devices, etc., following conditions shall be satisfied.

(a) The above copyright display, these terms of utilization, and the following stipulation of no guarantee shall be inserted in documentation accompanying redistribution (user's manual, etc.).

(4) The above copyright holder and the TOPPERS Project shall be exempt from responsibility for whatever damages occur either directly or indirectly through the utilization of this software.

This software is something that is provided with no guarantee. The above copyright holder and the TOPPERS Project make no guarantee whatsoever in regard to this software, including the possibility of its application. In addition, the above copyright holder and the TOPPERS Project shall also not bear responsibility for whatever damages occur either directly or indirectly through the utilization of this software.

**Parent topic:** [Notices](#)

## Copyright Notice

All rights reserved. No part of this publication may be reproduced, stored in a retrieval system, or transmitted in any form or by any means, electronic, mechanical, photocopying, recording, or otherwise, without the prior written permission of Seiko Epson Corporation. The information contained herein is designed only for use with this Epson product. Epson is not responsible for any use of this information as applied to other products.

Neither Seiko Epson Corporation nor its affiliates shall be liable to the purchaser of this product or third parties for damages, losses, costs, or expenses incurred by purchaser or third parties as a result of: accident, misuse, or abuse of this product or unauthorized modifications, repairs, or alterations to this product, or (excluding the U.S.) failure to strictly comply with Seiko Epson Corporation's operating and maintenance instructions.

Seiko Epson Corporation shall not be liable for any damages or problems arising from the use of any options or any consumable products other than those designated as Original Epson Products or Epson Approved Products by Seiko Epson Corporation.

This information is subject to change without notice.

[A Note Concerning Responsible Use of Copyrighted Materials](#)  
[Copyright Attribution](#)

**Parent topic:** [Notices](#)

## **A Note Concerning Responsible Use of Copyrighted Materials**

Epson encourages each user to be responsible and respectful of the copyright laws when using any Epson product. While some countries' laws permit limited copying or reuse of copyrighted material in certain circumstances, those circumstances may not be as broad as some people assume. Contact your legal advisor for any questions regarding copyright law.

**Parent topic:** [Copyright Notice](#)

## **Copyright Attribution**

© 2015 Epson America, Inc.

11/15

CPD-40856R2

**Parent topic:** [Copyright Notice](#)