

Ottocanali I204

Ottococanali I204 DSP+ETH

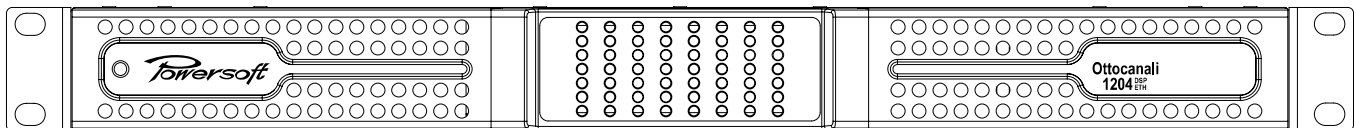

User Guide v 2.5

June 2013

1	Warnings	5
1.1	Important Safety Instructions	5
1.2	Warning Notices	5
1.2.1	Location.....	5
1.2.2	Precautions Regarding Installation.....	5
1.3	Safety Rules	6
1.4	Speaker Damage	6
1.5	Speaker Output Shock Hazard	6
2	Front and Rear Panel Reference Figures	7
3	Welcome	9
3.1	Introduction	9
3.2	The Ottocanali Series	9
3.3	More Sound and Less Weight	9
4	Installation	9
4.1	Unpacking	9
4.2	Mounting	9
4.3	Cooling	10
4.4	Operating Precautions	10
4.5	Grounding	10
4.6	AC Mains Connection	10
4.7	BatFormer®	10
5	Connections and Operation	13
5.1	Introduction	13
5.2	Front Panel Controls Access	13
5.3	Front Panel Adjustments	13
5.3.1	Output Level Adjustments.....	13
5.3.2	Energy Save.....	13
5.4	Front Panel Monitoring	14
5.5	Connecting Audio Inputs	15
5.6	Connecting Audio Outputs	15
5.7	Lo-Z and 70V/100V Operations	16
5.8	Bridge Mode Connection	16
5.9	Parallel Mode Connection	16
5.10	GPIO Operations	16
5.10.1	Alarms	16
5.10.2	Remote ON/OFF.....	16
5.10.3	Ethernet Port and Remote ID Selection*.....	16
5.10.4	V ext*.....	16
5.11	DSP features and operations*	18
5.11.1	What Are DSP Operations? What Are They For?*	18
5.11.2	DSP Features*.....	18
5.11.3	Internal Processing Layout*.....	18
5.11.4	Locking*.....	19
5.11.5	On/Off*.....	19
5.11.6	Preset Mangement*.....	19
6	Remote Control*	19
6.1	What is Armonía?*	19
6.2	Connecting The Device*	19
6.2.1	Network*.....	19
6.2.1.1	DHCP*.....	20
6.2.1.2	AUTOIP*.....	20
6.2.1.3	STATIC IP*.....	20
6.2.1.4	Revert From Static IP*.....	20
6.2.2	Discovery Device*.....	21
6.3	Setup Device*	21
6.3.1	Virtual Device*.....	21
6.3.2	Real Device*.....	21
6.4	File Operations*	22
6.4.1	Binary Preset File .preset*.....	22
6.4.2	Input/Output Curves .icp, .ocp.....	22
6.4.3	Channel Preset .chp*.....	22
6.4.4	Device Preset File .pam*.....	22
6.4.5	System File .paw*.....	23
6.5	DSP Remote Operations*	23
6.5.1	Routing*.....	23
6.5.2	Input Eq.*.....	23
6.5.3	Output Eq.*.....	24
6.5.4	Limiters*.....	24
6.5.4.1	RMS Limiter*.....	24
6.5.4.2	Peak Limiter*.....	24
6.5.5	Locking*.....	25
6.5.6	On Board Preset Operations*.....	25
6.5.7	Copy & Paste Operations*.....	25
6.5.7.1	Input/Output Eq Curves*.....	26
6.5.7.2	Channels*.....	26

6.5.7.3 Workspace*	.26
7 Protection	.26
7.1 Turn On/Turn Off Muting	.26
7.2 Short Circuit Protection	.26
7.3 Thermal Protection	.26
7.3.1 Thermal Warning	.26
7.3.2 Thermal Shutdown	.26
7.4 DC Fault Protection	.26
7.5 Input/Output Protection	.27
7.6 Check Line Integrity and Impedance Measurement*	.27
7.6.1 Programing Interface and Alarm Blocks Overview*	.27
7.6.2 Input Pilot Tone Detection*	.27
7.6.3 Output Pilot Tone Detection*	.28
7.6.4 Inner Pilot Tone Generator*	.28
7.6.5 Output Load Monitor*	.28
8 User Maintenance	.29
8.1 Cleaning	.29
8.2 Service	.29
8.3 Dust Removal	.29
9 Warranty	.29
10 Assistance	.30
11 Technical Specifications	.31
11.1 Ottocanali I204 DSP+ETH	.31
11.2 Ottocanali I204	.32
12 Appendix	.33
12.1 Setting An IP Policy On ADAU Based Devices With An External Lantronix Tool*	.33
12.1.1 Set IP configuration*	.33
12.1.2 Static IP*	.33
12.1.3 Revert From Static IP*	.34
12.2 Appendix: Output Configurations	.36
13 Troubleshooting	.40

I Warnings

I.1 Important Safety Instructions



CAUTION: TO REDUCE THE RISK OF ELECTRIC SHOCK, DO NOT ATTEMPT TO OPEN ANY PART OF THE UNIT. NO USER-SERVICEABLE PARTS INSIDE. REFER SERVICING TO QUALIFIED SERVICE PERSONNEL.

“WARNING: TO REDUCE THE RISK OF FIRE OR ELECTRIC SHOCK, DO NOT EXPOSE THIS APPARATUS TO RAIN OR MOISTURE. OBJECTS FILLED WITH LIQUIDS, SUCH AS VASES, SHOULD NOT BE PLACED ON THIS APPARATUS”

“TO COMPLETELY DISCONNECT THIS APPARATUS FROM THE AC MAINS, DISCONNECT THE POWER SUPPLY CORD PLUG FROM THE AC RECEPTACLE”

“THE MAINS PLUG OF THE POWER SUPPLY CORD MUST REMAIN READILY ACCESSIBLE”

SAFEGUARDS: Electrical energy can perform many useful functions. This unit has been engineered and manufactured to assure your personal safety. Improper use can result in potential electrical shock or fire hazards. In order not to defeat the safeguards, observe the following instructions for its installation, use and servicing.

- ▶ Read these instructions.
- ▶ Keep these instructions.
- ▶ Heed all warnings.
- ▶ Follow all instructions.
- ▶ Do not use this amplifier near water.
- ▶ Clean only with a dry cloth.
- ▶ Do not block any ventilation openings.
- ▶ Install in accordance with the manufacturer's instructions.
- ▶ Do not install near any heat sources such as radiators, heat registers, stoves, or other apparatus (including amplifiers) that produce heat.
- ▶ Do not defeat the safety purpose of the polarized or grounding-type plug. A polarized plug has two blades with one wider than the other. A grounding type plug has two blades and a third grounding prong. The wide blade or the third prong are provided for your safety. If the provided plug does not fit into your outlet, consult an electrician for replacement of the obsolete outlet.
- ▶ Protect the power cord from being walked on or pinched particularly at plugs, convenience receptacles, and the point where they exit from the apparatus.
- ▶ Only use attachments/accessories specified by the manufacturer.

- ▶ Unplug this amplifier during lightning storms or when unused for long periods of time. Refer all servicing to qualified service personnel. Servicing is required when the amplifier has been damaged in any way. For example if the power-supply cord or plug have been damaged, if liquid has been spilled or objects have fallen into the amplifier, if the amplifier has been exposed to rain or moisture, if it has been dropped or if it does not operate normally.

EXPLANATIONS OF GRAPHICAL SYMBOLS:



“The Lightning Flash with arrowhead symbol within an equilateral triangle is intended to alert the user to the presence of uninsulated “dangerous voltage” within the product enclosure that may be of sufficient magnitude to constitute a risk of shock to persons”.



“The exclamation point within an equilateral triangle is intended to alert the user to the presence of important operating and maintenance (servicing) instructions in the literature accompanying the product”.

I.2 Warning Notices



I.2.1 Location

Install the amplifier in a well-ventilated location where it will not be exposed to high temperature or humidity.

Do not install the amplifier in a location that is exposed to direct sun rays, or near hot appliances or radiators. Excessive heat can adversely affect the cabinet and internal components. Installation of the amplifier in a damp or dusty environment may result in malfunction or accident.

I.2.2 Precautions Regarding Installation

Placing and using the amplifier for long periods of time on heat generating sources will affect its performance. Avoid placing the amplifier on heat generating sources. Install this amplifier as far as possible from tuners and TV sets. An amplifier installed in close proximity of such equipment may experience noise or generic performance degradation.

WARNING. To prevent fire or electric shock:

- ▶ The ventilation openings must not be impeded by any item such as newspapers, tablecloths, curtains etc; keep a distance of at least 50cm from the front and rear ventilation openings of the amplifier.
- ▶ Do not expose this amplifier to rain or moisture.
- ▶ This equipment must not be exposed to dripping or splashing liquids: objects filled with liquids, such as vases, must not be placed on the amplifier.

I.3 Safety Rules



- ▶ This device must be powered exclusively by earth connected mains sockets in electrical networks compliant to the IEC 364 or similar rules.
- ▶ It is absolutely necessary to verify this fundamental requirement of safety and, in case of doubt, require an accurate check by qualified personnel.
- ▶ The manufacturer cannot be held responsible for damages caused to persons, things or data due to an improper or missing ground connection.
- ▶ Before powering this amplifier, verify that the correct voltage rating is being used.
- ▶ Verify that your mains connection is capable of satisfying the power ratings of the device.
- ▶ Do not spill water or other liquids into or on the amplifier.
- ▶ Do not use this amplifier if the electrical power cord is frayed or broken.
- ▶ Do not remove the cover. Failing to do so will expose you to potentially dangerous voltage.
- ▶ No naked flame sources such as lighted candles should be placed on the amplifier.
- ▶ Provide a sectioning breaker between the mains connections and the amplifier. The suggested device is a 10A/250V AC (230V AC mains voltage) or 16A/250V AC (110Vac mains voltage), C or D curve, 10KA.
- ▶ Contact the authorized service center for ordinary and extraordinary maintenance.

I.4 Speaker Damage



Powersoft Class D amplifiers are among the most powerful professional amplifiers available and are capable of producing much more power than many loudspeakers can handle. It is the user's responsibility to use speakers suitable to the amplifier and to use them in a sensible way that will not cause damage.

Powersoft will not be held responsible for damaged speakers. Consult the speaker manufacturer for power handling recommendations.

Even if you reduce the gain using the amplifier's front panel attenuation controls, it is still possible to reach full output power if the input signal level is high enough.

A single high-power tone can damage high frequency drivers almost instantaneously, while low frequency drivers can usually withstand very high, continuous power levels for a few seconds before they fail. Reduce power immediately if you hear any speaker "bottoming out" - harsh pops or cracking distortion that indicate that the speaker voice coil or diaphragm is striking the magnet assembly.

Powersoft recommends that you use amplifiers of this power range for more headroom (cleaner sound) rather than for increased volume.

I.5 Speaker Output Shock Hazard



A Class D amplifier is capable of producing hazardous output voltages. To avoid electrical shock, do not touch any exposed speaker wiring while the amplifier is operating.

This manual contains important information on operating your Powersoft amplifier correctly and safely. Please read it carefully before operating your amplifier. If you have any questions, contact your Powersoft dealer.

2 Front and Rear Panel Reference Figures

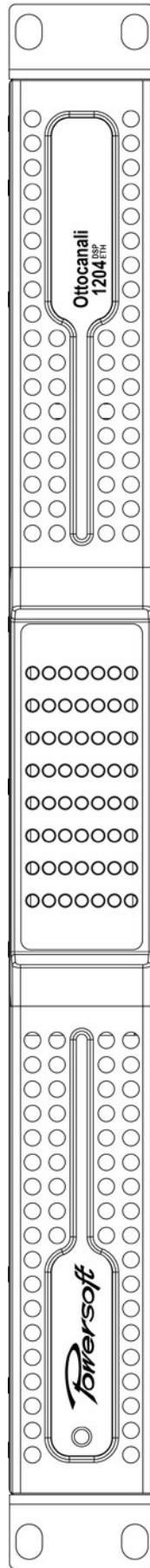

REF. FIGURE 1: Front panel view with closed side panels

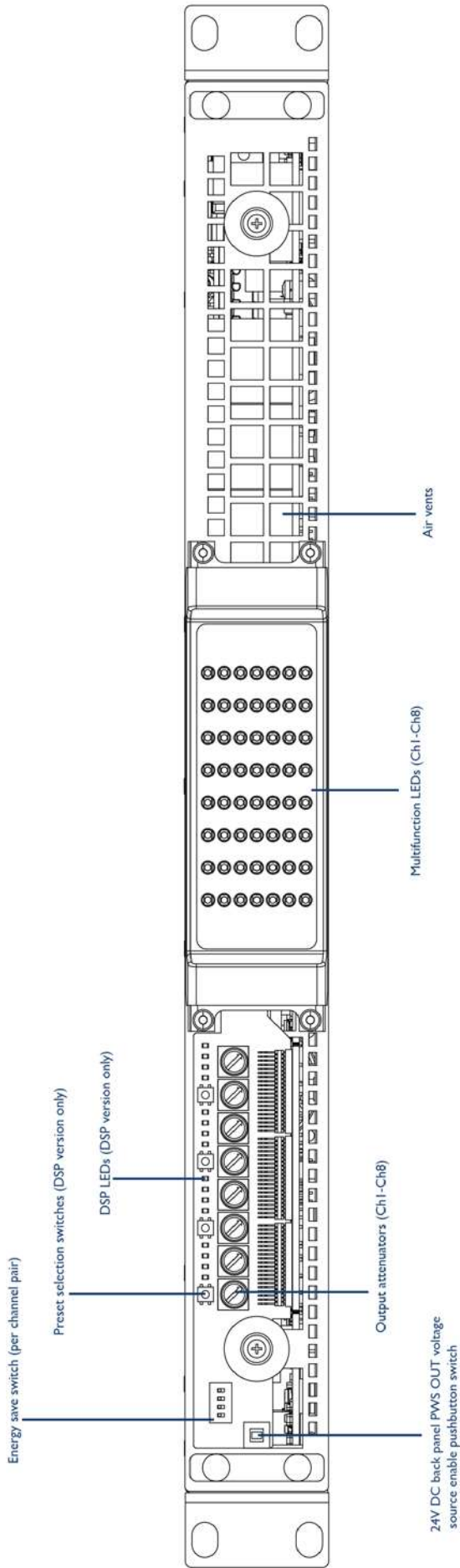

REF. FIGURE 2: Front panel view with opened side panels

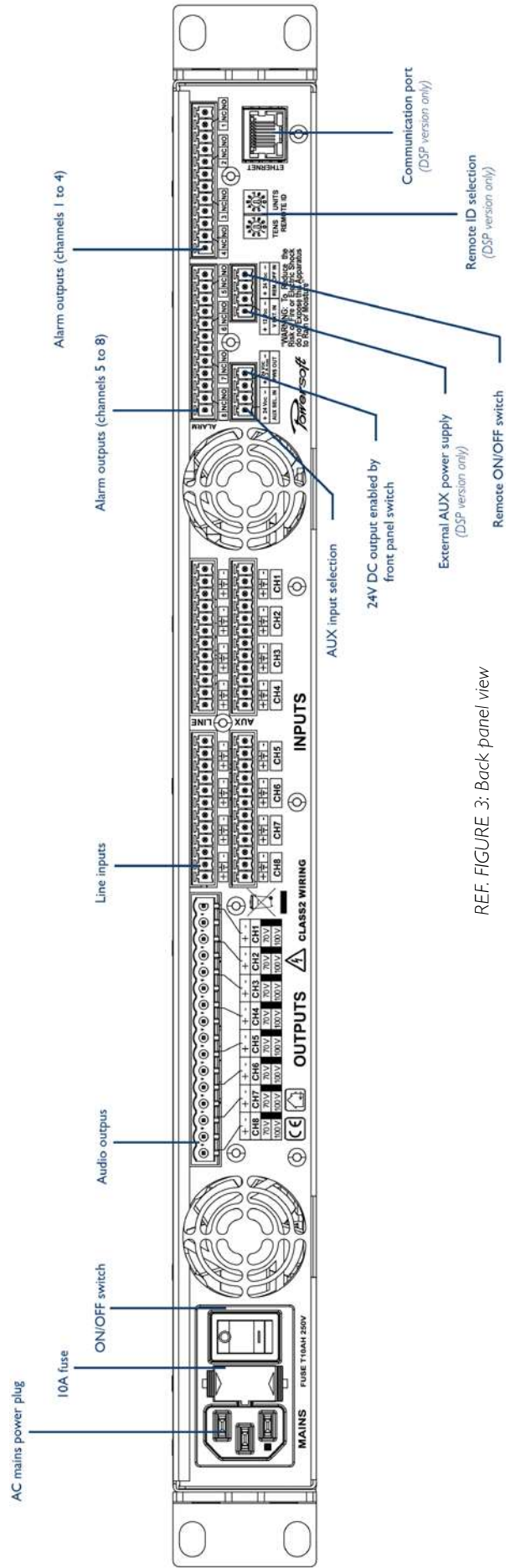

REF. FIGURE 3: Back panel view

3 Welcome

3.1 Introduction

Congratulations on buying a Powersoft Ottocanali amplifier! Powersoft is a leading company in the field of high efficiency audio power management. The Powersoft Class D technology has changed the way the world looks at professional audio amplification: no other amplifier's performance comes close for applications demanding high power and long term reliability. Thanks to amazing reductions in heat output and weight, without sacrificing output powers, Powersoft amplifiers can be used in an unlimited range of PA applications such as opera houses, theaters, churches, cinema, and theme parks.

3.2 The Ottocanali Series

The Ottocanali series of amplifiers are specifically designed for installation applications. The amplifiers in this series offer smaller dimensions, lighter weight and the traditionally amazing sound quality and reliability of all Powersoft products. The PFC (Power Factor Correction) feature allows flawless worldwide operation with any AC mains voltage, including 110V and 220V.

3.3 More Sound and Less Weight

Class D technology based amplifiers are highly efficient, delivering greater power to speakers with reduced heat dissipation: typical running efficiency of output stages is 95%, with only 5% of input energy dissipated as heat. This allows for smaller dimensions, weight and power consumptions.

Contrary to conventional amplifiers which achieve highest efficiency only at full rated power output, Class D efficiency is almost independent of output level. Music has an average power density of 40% of its peak value; this means that other (non-class D) amplifiers can easily generate 10 times more heat than Powersoft products for the same sound pressure level. This unit is designed to work with l_0-Z (from 4 Ω) and with 70V/100V distributed lines. It can deliver up to 150 W per channel (at 4 Ω) or 300 W in bridge mode on 8 Ω . The DSP + ETH version allows single channel processing and remote control of the amplifier.

Powersoft amplifiers deliver crystal-clear highs, and a tight, well-defined low end: the most accurate reproduction of an audio signal. Solid time proven design features ensure extremely high performance in terms of super low total harmonic distortion, optimal frequency response, high power bandwidth and damping factor across a vast number of application scenarios. Powersoft's multi patented application of Pulse Width Modulation (PWM) high frequency sampling techniques is just one of the many factors contributing to the Ottocanali's high performance ratings across the audio bandwidth.

The Show Always Goes On

The Ottocanali series offers complete protection against any possible operation error. Every amplifier in this series is designed to work under a large range of possible conditions, delivering maximum power with maximum safety and an outstanding long

term reliability. Anticipating potential problems at the design stage means your show always goes on!

4 Installation

4.1 Unpacking

Carefully open the shipping carton and check for any noticeable damage; the figure below (FIGURE 1) shows the packing view. Every Powersoft amplifier is completely tested and inspected before leaving the factory and should arrive in pristine condition. In the unlikely event that you should encounter any damage, please notify the shipping company immediately. Be sure to save all packing materials for the carrier's inspection.

The Ottocanali box contains the following:

- ▶ 1 Ottocanali amplifier
- ▶ 1 x AC Mains cord with 3-pin plug 15A for US, IEC 'Schuko' 16A for every other nation.
- ▶ 6 x 12 pin Phoenix MC 1.5/12-ST-3.81 1803675 connectors
- ▶ 2 x 4 pin Phoenix MC 1.5/4-ST-3.81 1803594 connectors
- ▶ 1 x 16 pin Phoenix MSTB 2.5/16-ST-5.08 1757158 connectors

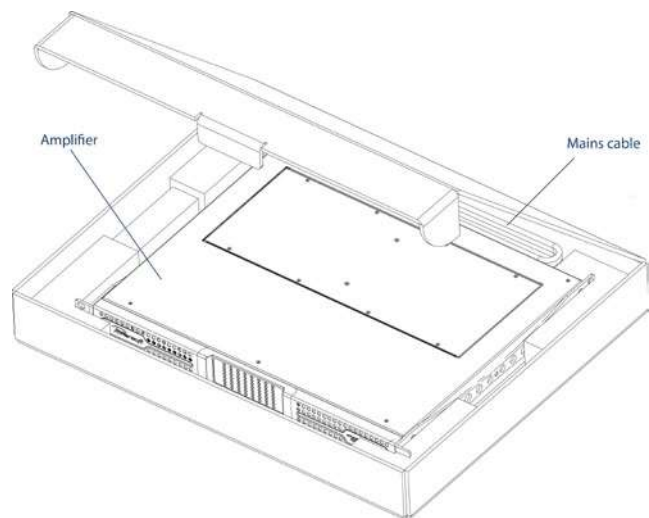

FIGURE 1: Ottocanali box

4.2 Mounting

All Powersoft amplifiers are designed for standard 19" rack mounting; there are four front panel holes and two rear-lateral holes. In order to limit the risk of mechanical damages, amplifiers must be fixed to the rack using both frontal as well as rear mounting holes (FIGURE 2).

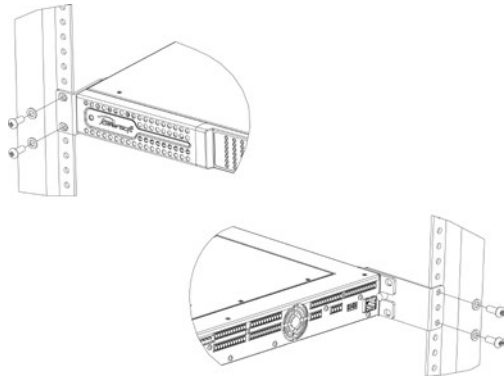

FIGURE 2: Amplifier rack mounting holes, front and back

4.3 Cooling

All Powersoft amplifiers implement a forced-air cooling system to maintain low and constant operating temperatures. Drawn by an internal fan, air enters through the slots in the front panel and is forced over all components, exiting at the back of the amplifier.

The amplifier's cooling system features an "intelligent" variable-speed DC fan which is controlled by heat sink temperature sensing circuits: the fan speed will increase only when the temperature recorded by the sensors rises over carefully predetermined values. This ensures that fan noise and internal dust accumulation are kept to a strict minimum. Should however the amplifier be subject to an extreme thermal load, the fan will force a very large volume of air through the heat sink. In the extremely rare event that the amplifier should dangerously overheat, sensing circuits shut down all channels until the amplifier cools down to a safe operating temperature. Normal operation is resumed automatically without the need for user intervention.

When mounting Ottocanali amplifiers, the exhaust heat should be taken into consideration.. Exhaust cooling air is forced out through the rear of the chassis (FIGURE 3); make sure there is enough space around the back of the amplifier for this air to escape. Ottocanali amplifiers can be stacked one on top of the other due to the efficient cooling system they are equipped with. There is however a safety limit to be observed: in case a rack with closed back panels is used, leave one rack unit empty every four Ottocanali amplifiers installed to guarantee adequate air flow.

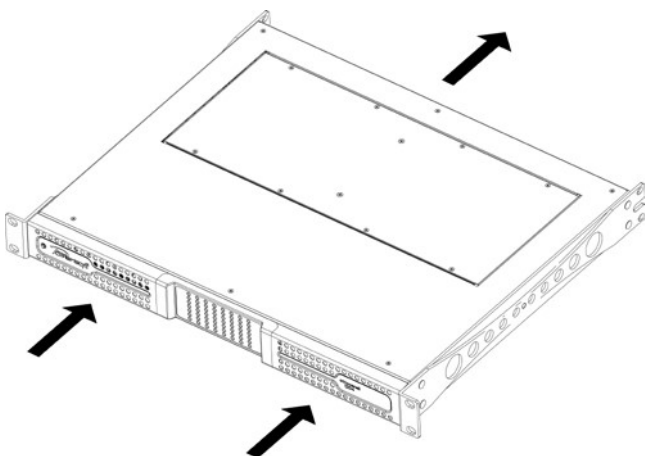

FIGURE 3: Forced air cooling: front to back airflow

4.4 Operating Precautions

Make sure the power switch is off before attempting to make any input or output connections.

Make sure the AC mains voltage used is within the acceptable operating voltage range specified in the Ottocanali documentation (100V-240V \pm 10%). Damage caused by connecting the amplifier to an improper AC mains voltage is not covered by the warranty.

By using good quality input and speaker cables, the likelihood of erratic signal behavior is reduced to a minimum. Whether you make them or buy them, look for good quality wires, connectors and soldering techniques.

4.5 Grounding

There is no ground switch or terminal on the Ottocanali Series amplifiers. All shield terminals of input connections are directly connected to the chassis. This means that the unit's signal grounding system is automatic. In order to limit hum and/or interference entering the signal path, use balanced input connections.

In the interests of safety, the unit MUST always operate with electrical safety earth connected to the chassis via the dedicated wire in the 3-wire cable. Never disconnect the ground pin on the AC mains power cord.

4.6 AC Mains Connection

The AC Mains connection is made via the IEC type connector on the back of the amplifier. The PFC feature allows the Ottocanali to work within a range of different AC mains voltages without the need to adjust any settings; however, make sure your AC mains power source operates within the voltage limits indicated on this manual (100V-240V \pm 10%). The 10A mains fuse and spare fuse are located between the on/off switch and the IEC type mains connector. Please see REF. FIGURE 3.

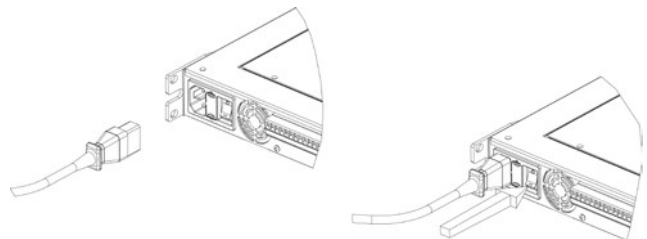

FIGURE 4: Mains connector and on/off switch

SAFETY WARNING! Ground wires must be connected! Do not use adapters that disable grounding.

4.7 BatFormer®

It is possible to connect any Ottocanali channel directly to a 70V/100V distributed line using an optional BatFormer. BatFormers are specifically designed to be easily installed by an authorized service center.

How to install a BatFormer

1. Remove the amplifier top panel by removing the (10) screws.

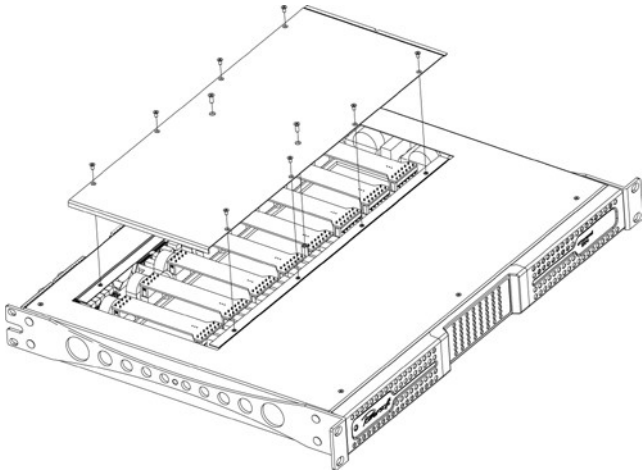

FIGURE 5: Top panel removal

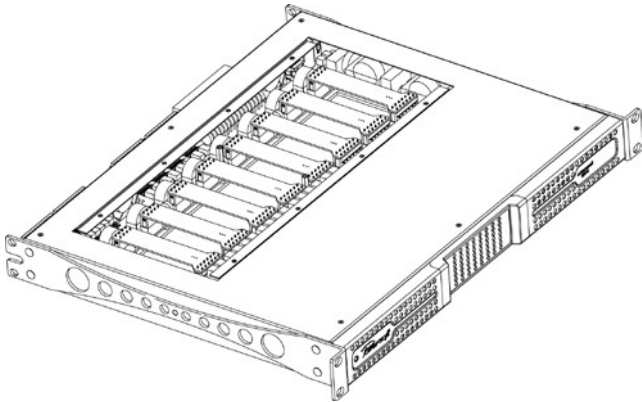

FIGURE 6: Exposed jumper boards

2. Remove the lo-Z connection jumper board by carefully pulling upward.

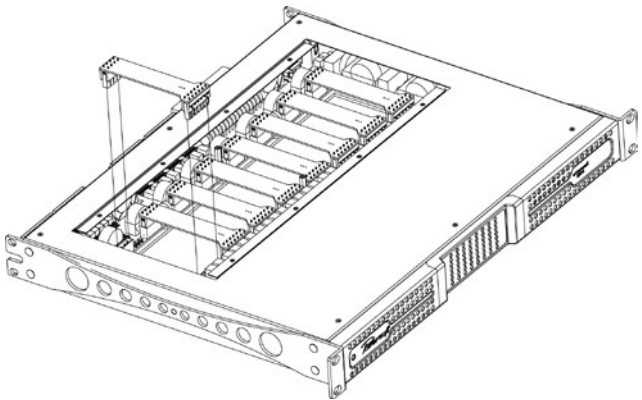

FIGURE 7: Jumper board removal

3. Align the BatFormer so that the 6-pin connector faces the front panel (see figure below).

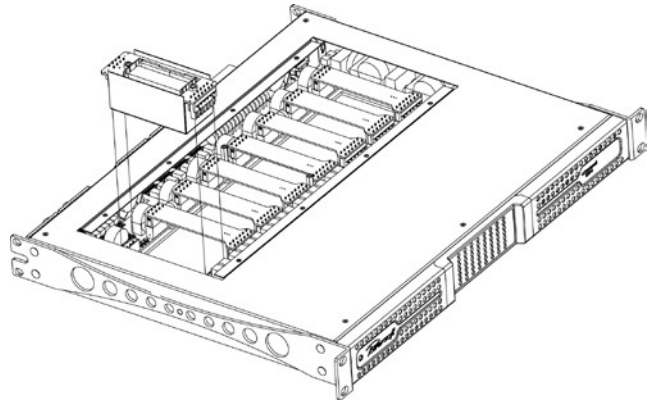

FIGURE 8: BatFormer insertion

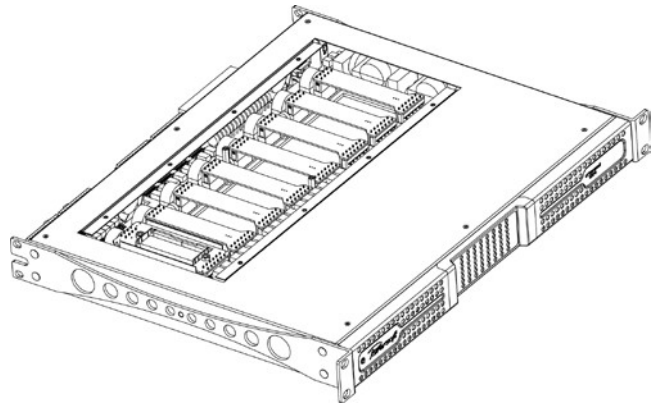

FIGURE 9: BatFormer inserted, top panel removed

4. Carefully insert the BatFormer by gently pressing down on both sides.

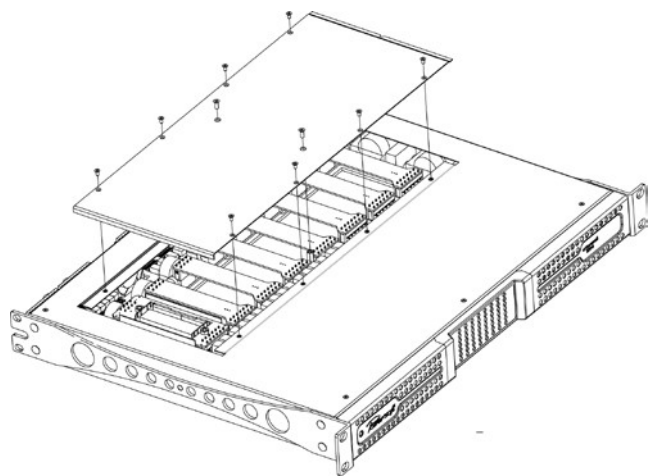

FIGURE 10: Top panel repositioning

5. Reposition amplifier top panel and secure with screws.

There are silkscreened labels underneath the output connectors on the back panel that are meant for authorized service centers to indicate which channels have BatFormers installed and are therefore capable of driving a 70V or 100V distributed line (see REF. FIGURE 5).

Connection type	Output CH1 +	Output CH1 -	Output CH2 +	Output CH2 -	Output CH3 +	Output CH3 -	Output CH4 +	Output CH4 -	Output CH5 +	Output CH5 -	Output CH6 +	Output CH6 -	Output CH7 +	Output CH7 -	Output CH8 +	Output CH8 -
Single end Lo-Z 70V/100V	Spk1_+	Spk1_-	Spk2_+	Spk2_-	Spk3_+	Spk3_-	Spk4_+	Spk4_-	Spk5_+	Spk5_-	Spk6_+	Spk6_-	Spk7_+	Spk7_-	Spk8_+	Spk8_-
Bridge Lo-Z	Spk1_+	NC	NC	Spk1_-	Spk2_+	NC	Spk2_-	NC	Spk3_+	NC	NC	Spk3_-	Spk4_+	NC	NC	Spk4_-

REF. FIGURE 4: Output connection mode chart

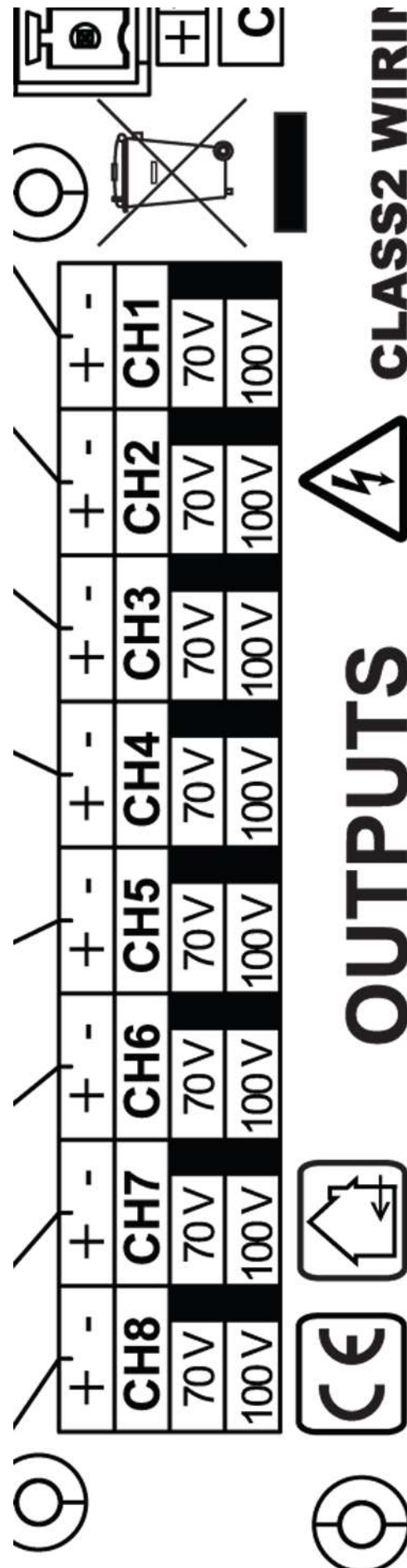

REF. FIGURE 5: Back panel silkscreened labels

5 Connections and Operation

5.1 Introduction

This section provides information on amplifier connection and operation. For optimal amplifier performance, it is important to understand the meaning of the information that the Ottocanali amplifier can provide regarding its status and configuration. This information is available to the user both via front panel indicators as well as through specific alarm signals broadcasted from dedicated connectors on the back of the unit. This chapter will break down all the front panel operations and monitoring functions the Ottocanali is capable of. The remaining part of the chapter will explain how to correctly connect the amplifier's inputs and outputs.

5.2 Front Panel Controls Access

A number of important controls can be accessed by removing the front left hand side protective panel bearing the Powersoft logo. Both silver colored metal panels are attached to the chassis magnetically and can therefore be removed quickly without the aid of any specific tool.

The following procedure can be used to remove both the left as well as the right hand front panels. Removing the right hand panel, however, does not grant access to any controls and is useful only for air filter access (see Section 8.3).

To remove the left hand side front panel bearing the Powersoft logo:

1. Firmly grip the outermost left hand side of the silver colored panel and pull outwards at an angle, as if opening a door hinged on the right hand side
2. Carefully slide the metal panel away from the chassis. When the front panel is removed, the air filter (looking like a shiny black plastic sponge) will be exposed.

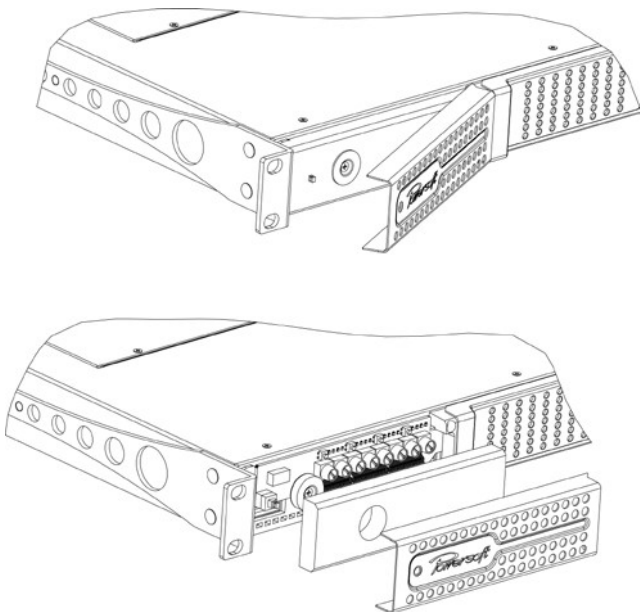

FIGURE 11: Magnetic side panel removal

To reposition the left hand side silver panel:

1. Secure the air filter to the amplifier chassis by placing it in its designated area and press lightly, so that the filter's central cut hole can brace the magnetic snap mechanism
2. Align the silver panel's right hand side to the chassis at the same angle used to remove it
3. When correctly positioned, the magnetic snap mechanism will automatically secure the metal panel in place.

The controls positioned behind the left hand side silver colored Powersoft logo panel allow access to a series of important features:

- ▶ Output channel attenuation adjustment (see Section 5.3.1)
- ▶ Preset selection, one per channel pair (DSP version only)
- ▶ AUX Input/Line Input toggle (see Section 5.5)
- ▶ GPIO operations (see Section 5.10)
- ▶ Channel pair energy save mode selection (see Section 5.3.2)

5.3 Front Panel Adjustments

There are two types of adjustments that are possible from the Ottocanali front panel: output level attenuation and energy save mode.

5.3.1 Output Level Adjustments

Removing the left hand side metallic panel exposes one attenuator knob for each channel, numbered one through eight starting from the left hand side. Each channel's output attenuation level can be set to any value from 0 to ∞ . Attenuation level decreases by rotating the blue knob clockwise.

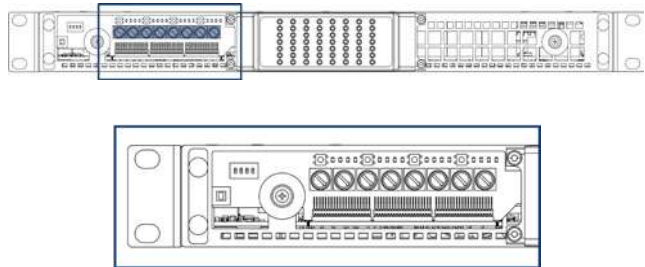

FIGURE 12: Front panel left hand side output attenuators

5.3.2 Energy Save

Energy save capabilities can be activated for each channel pair. When the energy save mode is activated on a channel pair, the Ottocanali enters a low power consumption idle state when no signal activity is detected for more than 4 seconds. Normal operation is resumed in a matter of milliseconds when an incoming signal is detected on the channel pair.

Idle Power Consumption Energy Save Mode OFF				
AC Mains Voltage (V)	Current (A)	Real Power (W)	Apparent Power (VA)	Power Factor
115	0.27	14.7	31.05	0.47
230	0.33	15.6	75.9	0.21
Idle Power Consumption Energy Save Mode ON				
AC Mains Voltage (V)	Current (A)	Real Power (W)	Apparent Power (VA)	Power Factor
115	0.21	8.7	23.5	0.37
230	0.3	9.3	67.2	0.14

FIGURE 13: Energy save mode on/off: idle power consumption chart for the Ottocanali without optional DSP

Idle Power Consumption Energy Save Mode OFF				
AC Mains Voltage (V)	Current (A)	Real Power (W)	Apparent Power (VA)	Power Factor
115	0.33	20	38	0.52
230	0.36	21.2	84.2	0.25
Idle Power Consumption Energy Save Mode ON				
AC Mains Voltage (V)	Current (A)	Real Power (W)	Apparent Power (VA)	Power Factor
115	0.26	13.9	30.6	0.45
230	0.34	14.6	79	0.18

FIGURE 14: Energy save mode on/off: idle power consumption chart for the Ottocanali with optional DSP

In order to enable energy saving mode for a channel pair, the DIP switch on the left hand side of the front panel must be set to OFF (down).

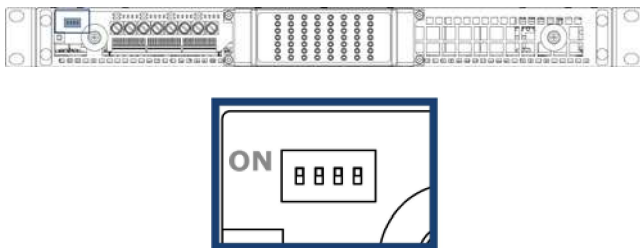

FIGURE 15: DIP switch for energy save mode

5.4 Front Panel Monitoring

The Ottocanali front panel provides important information on the state of the amplifier. It is important to know and understand the meaning of every front panel indicator in order to have crucial information on the operational state of the amplifier.

There are two sets of LEDs on the Ottocanali front panel. On the upper portion of the left hand side of the front panel are 16 LEDs, 4 for each channel pair, available for DSP functions.

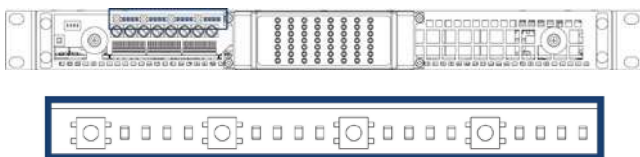

FIGURE 16: Front panel left hand side DSP LEDs

For models including a DSP: the lighted LED indicates which preset is active for that specific channel pair. The first leftmost set of 4 LEDs refers to channels 1 and 2, the second set of 4 LEDs refers to channels 3 and 4 and so on. Preset parameters are defined, set and modified by connecting the Ottocanali amplifier to a computer using the Armonía Pro Audio Suite software. The pushbutton on the left of each set of 4 LEDs allows to manually select the preset for that particular channel pair. Pushing the button will cycle between all 4 available presets.

On the central portion of the front panel of the Ottocanali are 8 columns of 7 LEDs, one column for each channel.

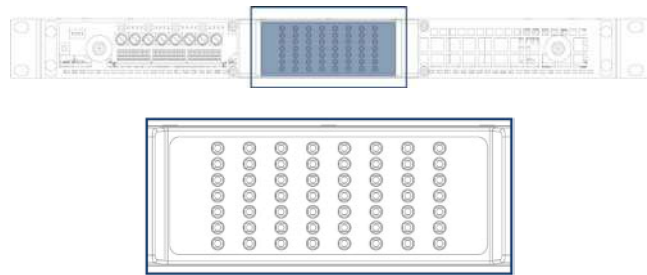

FIGURE 17: Front panel LEDs

Some of these LEDs have multiple signaling modes, e.g. metering or alarm modes. Their function is summarized in the following chart:

LED	Color	Solid ON	Blinking
	Red	Channel output level has reached clipping limits OR Channel has been muted due to heat sink temperature rising above 80°C ¹⁾	
	Yellow	Channel output level is above -6dB of max output level OR Thermal warning: heat sink temperature is above 70°C ²⁾	
	Green	Channel output level is above -12dB of max output level	
	Green	Channel output level is above -24dB of max output level	
	Green	Input signal is above -60dBV	
	Green	Channel is ready	
	Green	--	AUX inputs are selected

FIGURE 18: Front panel LEDs chart

¹⁾ Even if only one channel causes thermal overload, all channels are muted and all red LEDs are on.

2) Even if only one channel causes thermal warning, all yellow LEDs are on.

5.5 Connecting Audio Inputs

Audio input connections are made via two 12-pin Phoenix MC 1.5/12-ST-3.81 terminal block connectors:

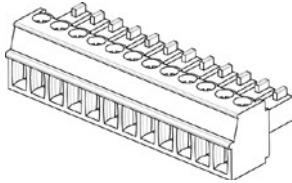

FIGURE 19: Audio input terminal block connector

Input connectors are placed on the back of the Ottocanali and grouped in two rows:

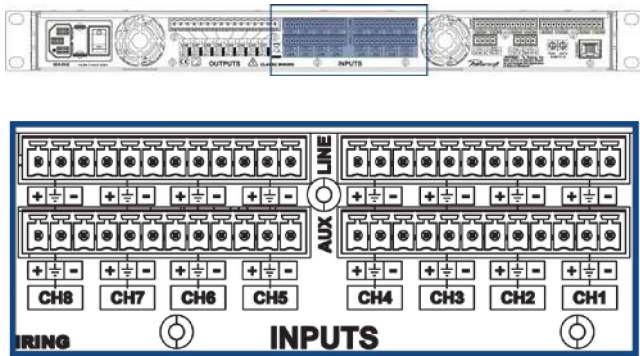

FIGURE 20: Rows of input connectors

- ▶ The topmost line of connectors is for line input
- ▶ The second row of connectors is for auxiliary input

Line Input/Aux Input toggle:

The amplifier switches from line inputs to auxiliary inputs when a constant voltage in the 12V to 30V range is applied to the "AUX SEL" connector. When this voltage is removed from the "AUX SEL" connector, the unit switches back from auxiliary inputs to line inputs.

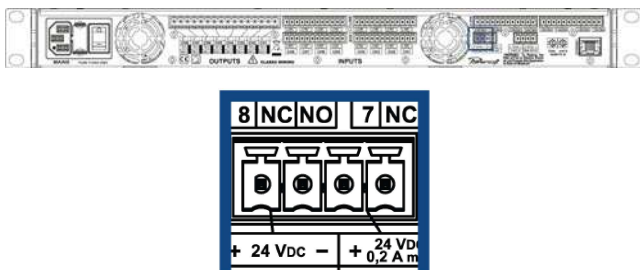

FIGURE 21: AUX SEL connector

The Ottocanali amplifier provides an additional procedure to switch from line inputs to auxiliary inputs. The "PWS OUT" connector can provide a 24V DC (0.2 A max, symmetrical with respect to ground) when enabled by the left hand front panel toggle switch.

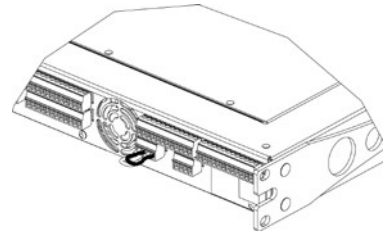

FIGURE 22: AUX SEL and PWS OUT connection

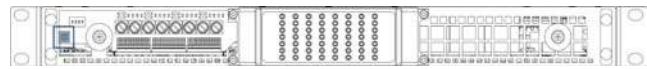

FIGURE 23: PWS OUT port on the back of the Ottocanali amp

By connecting the "PWS OUT" connector to the "AUX SEL" (see FIGURE 22) the front panel switch will toggle between line inputs and auxiliary inputs. The following diagram explains the relationship between the front panel toggle switch and the PWS OUT port.

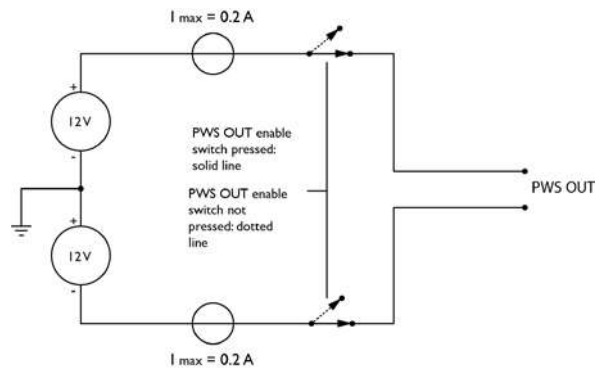

FIGURE 24: PWS OUT port vs front panel switch diagram

5.6 Connecting Audio Outputs

Warning! Lethal voltage levels may be present at the loudspeaker connectors when the amp is turned on!

A 16-pin Phoenix MSTB 2.5/16-ST-5.08 terminal block connector is provided for the amplifier's output connections. The + pin of the connector corresponds to the positive output of the channel. Ensure that the speakers are connected to the Ottocanali output with the correct polarity.

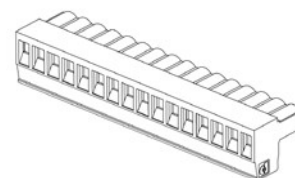

FIGURE 25: Audio output terminal block connector

Both bridge as well as single end output connection modes are possible and can be mixed: for example, channels 1 and 2 can

be connected in bridge mode, while channels 3 and 4 can be connected single end.

REF. FIGURE 4 summarizes common connection modes with corresponding connection polarities. Speaker cables are labeled as spkX₊ and spkX₋, where X represents the speaker number.

5.7 Lo-Z and 70V/100V Operations

Any channel of the Ottocanali amplifier can drive either a lo-Z or a 70V/100V (hi-Z) line. In order to connect any channel's output to a 70V/100V line, the factory supplied connection jumper must be replaced with a BatFormer (optional). Please refer to 4.7 for instructions on how to correctly install a BatFormer. BatFormer installation must be carried out by authorized service centers.

5.8 Bridge Mode Connection

Bridge mode connection of outputs is possible only in lo-Z operational mode. Bridging of adjacent channels is allowed for the following pairs: channels 1 with 2, 3 with 4, 5 with 6, 7 with 8. Bridging is NOT possible for other pairs, for example channels 4 and 5. In order to obtain a bridge connection of the outputs, inputs must be connected in parallel and outputs in series on a minimum load of 8 Ω. Please refer to REF. FIGURE 6 for a connection diagram example.

5.9 Parallel Mode Connection

Parallel connection of output channels is allowed only for hi-Z operational modes; this means that in order to connect output channels in parallel, these MUST be equipped with optional BatFormers. Only the following channel pairs can be connected in parallel: 1 with 2, 3 with 4, 5 with 6, 7 with 8. Parallel connection of channels 4 with 5, for example, is not allowed. In order to obtain this kind of connection, both the input channel pair as well as the output channel pair must be connected in parallel. Please refer to REF. FIGURE 7 for a connection diagram example.

5.10 GPIO Operations

General Purpose Input/Output Operation (GPIO) refers to a generic two pin contact (balanced or unbalanced) that can control or can be controlled by another system. The Ottocanali's GPIO system implements digital trigger signals to broadcast alarms or allow remote unit on/off switching.

5.10.1 Alarms

To ensure problem-free and efficient interaction with external devices, the Ottocanali provides two 12-pin Phoenix MC 1.5/12-ST-3.81 connectors on the back panel.

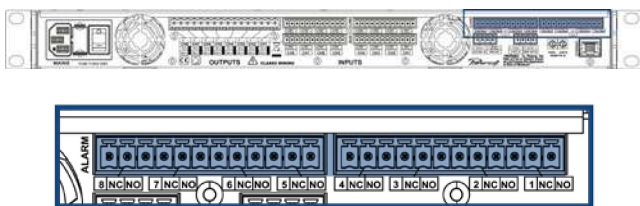

FIGURE 26: Back panel alarm output connectors

These contacts are used to report potentially dangerous faults or generally unsafe operation conditions by toggling alarm switches relative to events such as:

- ▶ DC presence at the output: when a dangerous DC component is present in the output power signal
- ▶ Thermal stress: when heat dissipation is not sufficient and heat sink temperature rises.

For a detailed account of protective measures relative to these alarms, please see Chapter 7.

5.10.2 Remote ON/OFF

By applying 24V DC (range from 15V to 30V DC) to the “REM OFF” connector located at the back of the Ottocanali, the amplifier can be remotely switched on and off. When a 24V DC voltage is applied to the REM OFF 2-pin Phoenix MC 1.5/4-ST-3.81 connector, the amplifier switches off immediately. When the 24V DC voltage is removed, the amplifier switches back on as per normal boot up operation.

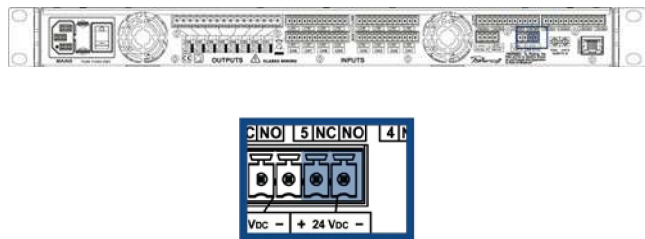

FIGURE 27: REM OFF connector

5.10.3 Ethernet Port and Remote ID Selection*

The rear panel of the Ottocanali has one RJ45 port, 100Mbit autosense Ethernet port for networking purposes. Below these ports are two numeric encoders that enable remote ID selection, needed to identify the amp when it is connected remotely. The left hand side dial sets the tens while the right hand side sets the units. Valid ID numbers go from 01 to 99.

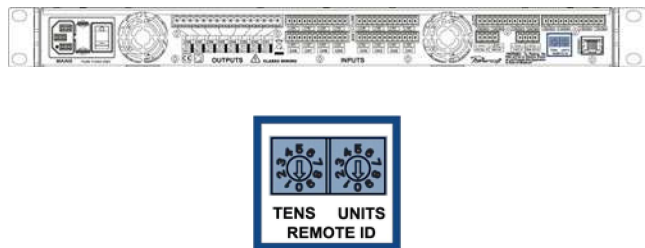
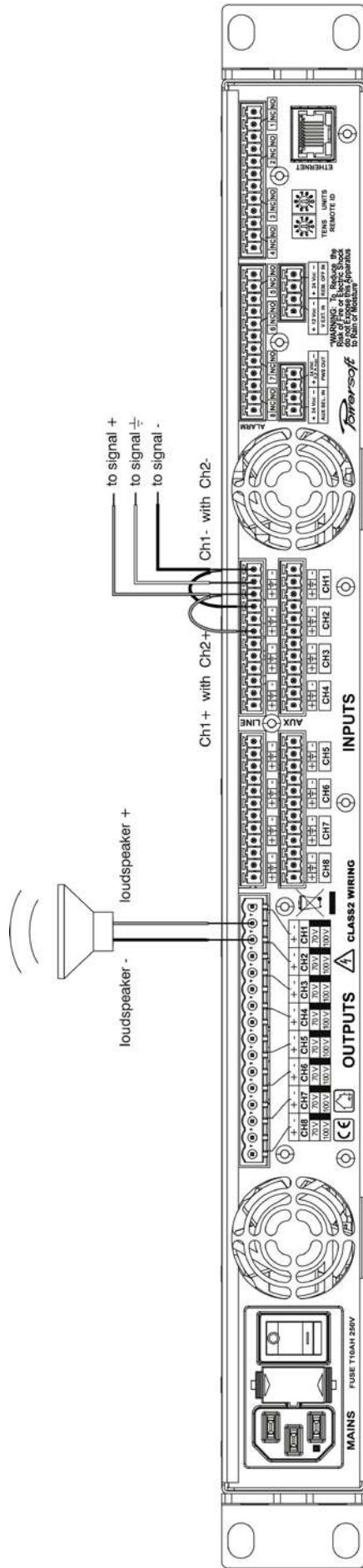

FIGURE 28: REM OFF connector

5.10.4 V ext*

The “V ext” terminal, located on the rear panel of the Ottocanali, is used to supply the amplifier’s internal Ethernet controller with the minimum required power for remote on/off switching operations. When the V ext port is powered by an external 9 V- 12 V DC (1 A) power supply, the Ethernet controller is enabled to listen for incoming connections such as device power-on commands.



REF. FIGURE 6: Bridge mode output connection of channel 1 and channel 2, lo-Z only

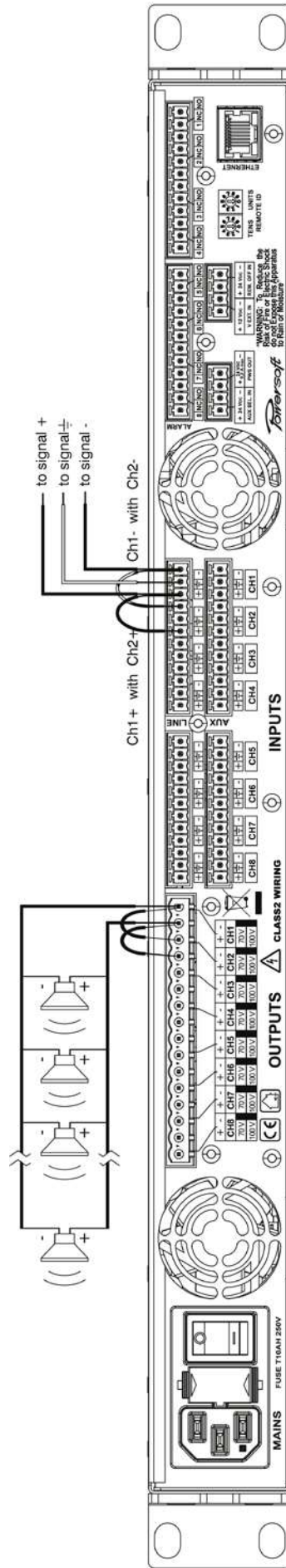

REF. FIGURE 7: Parallel output connection of channels 1 and 2, Hi-Z only (both channels must be equipped with optional BatFormers)

5.11 DSP features and operations*

5.11.1 What Are DSP Operations? What Are They For?*

The main purpose of Digital Signal Processing (DSP) operations is to allow the end user to program signal handling and processing in order to:

1. Select and handle the source signal
2. Process the signal for system operation
3. Process the signal to improve multi way speaker sound quality and protect speaker drivers

Furthermore, the DSP allows access to real-time information on the internal device operation, which allows better and faster amplifier response in terms of control as well as providing the end user with reliable information on what's happening inside the device.

5.11.2 DSP Features*

The Ottocanali amplifier DSP is based on the DSP-C, a multiplatform board used in many Powersoft products. Based on Analog Devices' ADAU 1701, the DSP-C board's flexible design caters a wide range of users: from the speaker manufacturer to the end user of rack amplifiers. The DSP-C provides both a completely programmable DSP to the experienced user as well as a complete tool with remote control for the end user. The ADAU 1701 device is a fixed point DSP with 26-bit resolution for the internal path and 56-bit for internal processing. The board also provides full remote control through Armonía Pro Audio Suite. The Ottocanali DSP is modular for any channel pair, meaning, for example, one module is available for channels 1 and 2 and another for channels 3 and 4 and so on. Keep in mind that the modules are physically separated, therefore input or output from different modules can't be mixed together.

Input routing selection and internal signal route. Keep in mind that due to the internal structure it is impossible to mix signals between non adjacent channels, for example channels 1 and 4 cannot be mixed together but only channels 1-2, channels 3-4, channels 5-6 and channels 7-8 can. The following configurations are possible for any channel pair:

- ▶ Mono input from IN1
- ▶ Mono input from IN2
- ▶ 2 inputs – 2 outputs
- ▶ Mono mix IN1&IN2

Input section, allows system operation to improve sound for a specific zone, group of speakers, room, etc. The input section provides an input eq for any input channel with the following features.

- ▶ 5 biquad filters, any filter can become PEQ, shelving hi-lo pass, all pass
- ▶ Delay of 16 ms
- ▶ Gain between -40 dB and 6 dB
- ▶ Mute
- ▶ Reverse polarity

Output section, allows multiway cabinet equalization and protection. The output section comprises an output eq and a limiter (peak and RMS) for each channel.

EQ feature:

- ▶ 8 biquad filters, any filter can become PEQ, shelving hi-lo pass, all pass. The crossover functions are obtained using one to four biquad filters for each crossover.
- ▶ Gain between -40 dB and 6 dB
- ▶ Mute
- ▶ Reverse polarity

Peak limiter feature:

- ▶ Threshold, 10 – 45 V. With 0.5 V steps
- ▶ Hold time, 0 – 2 sec. With 1 ms steps
- ▶ Release time, 0 – 2 sec. With 1 ms steps

Rms limiter feature:

- ▶ Threshold, 13 – 312 W @ 8 Ω. With step of 1 W
- ▶ Attack time, 2 – 4500 ms. With step of 1 ms
- ▶ Hold time, 0 – 1 sec. With step of 1 ms
- ▶ Release time, 4 – 4500 ms. With step of 1 ms

5.11.3 Internal Processing Layout*

The following figure summarizes the internal DSP processing signal path.

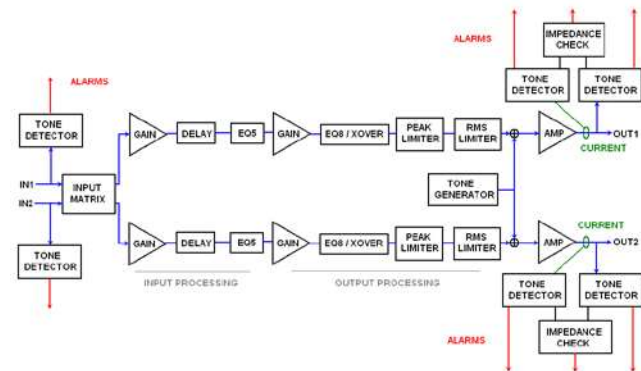

FIGURE 29: DSP processing blocks

NOTE: The following information is valid for any single DSP module (2 channels). The Ottocanali is formed by 4 completely independent modules.

Input routing, the following configurations are available:

- ▶ 1 input-2 outputs, the input is routed from channel 1 to both channels
- ▶ 1 input-2 outputs, the input is routed from channel 2 to both channels
- ▶ 2 inputs-2 outputs, the inputs are routed on the respective output channels
- ▶ 2 inputs-2 outputs, the input is routed from channel 1 and channel 2 and mix together; the mono mix function sums the two sources and halves their summed level

Output section. Every module provides each channel a set of 8 biquad filters and a complete set of limiters for protection purposes.

- ▶ Output eq: 8 biquad filters can be chosen for shaping (PEQ, shelving, etc) but these are shared between the crossovers. Each crossover can consume 1 to 4 biquad filters, depending on the crossover slope. The chart below illustrates a number of crossover configurations. Mixed crossover configurations are possible (e.g. HP 12 dB/oct, LP 24 dB/oct)

1 cover	Slope 6/12 (db/oct)	Slope 18/24 (db/oct)	Slope 30/36 (db/oct)	Slope 40/48 (db/oct)
Free biquad filters remaining	7	6	5	4

2 cover	Slope 6/12 (db/oct)	Slope 18/24 (db/oct)	Slope 30/36 (db/oct)	Slope 40/48 (db/oct)
Free biquad filters remaining	6	4	2	0

- ▶ Peak limiter for every output
- ▶ RMS limiter for every output

5.11.4 Locking*

The locking mechanism allows to lock macro property values based on the functional sub section and on the channel base of the device; the lockable sub sections are:

- ▶ Input routing:
 - ▶ Routing selection
 - ▶ Input Section
 - ▶ Equalizer
- ▶ Output Section
 - ▶ Equalizer
 - ▶ RMS limiter
 - ▶ Peak Limiter

Every channel subsection is independently lockable.

5.11.5 On/Off*

The on/off function is available when an external voltage is supplied. Please refer to Section 5.10.4 for further information.

5.11.6 Preset Management*

The DSP allows to manage up to 4 presets per module and its associated channel pair. Each preset contains information on the following:

- ▶ Input routing
- ▶ Input Section
- ▶ Output Section
- ▶ Properties locking

The preset is handled by the client as a file with the .preset

extension, see Section 6.4.1 for further information.

These presets can be selected via a preset selection button on the front panel of the amp. There is one button for each DSP module (see Section 5.4). The manual preset selection function is disabled if the amplifier is remotely controlled by any client.

WARNING: selecting a preset with a rear button or via remote control will interrupt the audio stream for some seconds.

WARNING: store the modified preset before turning the unit off or all changes will be lost. (Please refer to Section 6.5.6 on how to access this feature).

NOTE: selecting presets with the rear button is enabled only if remote control is NOT active.

6 Remote Control*

The Ottocanali DSP allows full amplifier remote control with Powersoft's software client Armonía. Other third party clients are also available.

6.1 What is Armonía?*

Armonía is a software environment entirely developed in-house by Powersoft. Its two main features are full end user remote control of the amp and its signal processing capabilities. The intuitive interface provides reliable information and real time control of all DSP functions. Refer to the Armonía manual for installation and configuration of the client software.

6.2 Connecting The Device*

This chapter illustrates how to setup the remote control of one or more amplifiers.

6.2.1 Network*

Ottocanali amplifiers come with one rear RJ45 port for remote device communication, using the IP layer and the UDP protocol. Factory default settings are DHCP/AutoIP, but a fixed IP policy can also be adopted.

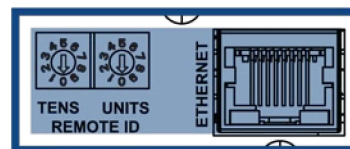
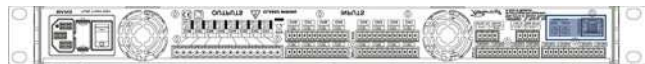

FIGURE 30: Rear Ethernet port and ID selection

6.2.1.1 DHCP*

When the data cable is connected the amplifier begins DHCP handshaking. If a DHCP server is present on the network, the unit is ready to be remotely controlled.

6.2.1.2 AUTOIP*

Every device tries to set up network communication when the data cable is plugged in and connected to another device (PC, switch, etc.). If a DHCP server is not active in the device network the units initiates a stateless address auto-configuration. It self assigns a link-local address of the type 169.254.x.y with a subnet mask 255.255.0.0. Please make sure that your PC is in the same subnet of the unit. Modern operating systems provide Zeroconf features for network auto-configuration.

6.2.1.3 STATIC IP*

Ottocanali Series devices can be set up with a static IP (or any other IP policy) with the Armonia control software. In order to set up the IP address please follow the following steps:

- ▶ Connect the device in a network with or without DHCP (see the the previous paragraph).
- ▶ Discover the device and import it in the workspace (refer to the Armonia user guide).
- ▶ Go to the device scheme tab and select the Network Settings button.



FIGURE 31: Enter the network settings

- ▶ Select the Static addressing mode from the combo box

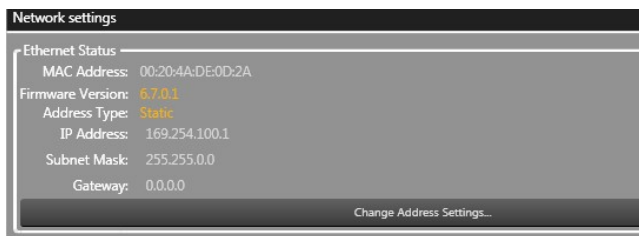

FIGURE 32: Select the static IP policy

- ▶ Insert the desired IP Address and network mask, specifying the gateway necessary only in complex LANs.

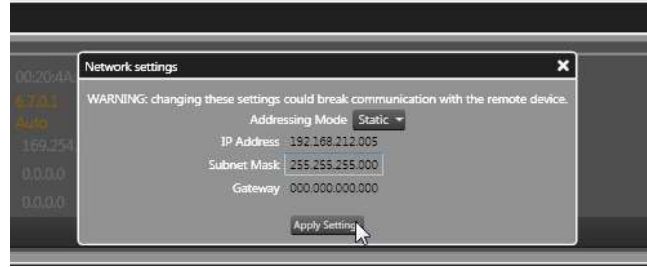

FIGURE 33: Insert IP, subnet and net mask in the form

- ▶ Click apply settings button.

WARNING: the device is reachable only from PCs in the same subnet mask, if this information is lost, you need to re-init the network device with a third-party software. Refer to Section 12.1.

- ▶ When done, the device network will restart automatically. About 15 seconds are necessary for the device to reconnect.

6.2.1.4 Revert From Static IP*

If for any reason re-programming the IP address or the IP policy of your unit should be necessary, follow the instructions in the previous chapter and make a different selection when assigning the IP. For example, should you need to revert the device to the automatic (DHCP, Zerocon) IP settings, please follow these steps:

- ▶ Connect the device in a network with or without DHCP (see the the previous paragraph).
- ▶ Discover the device and import in the workspace (refer to the Armonia user guide). Device and PC must use the same subnet. If you are not able to reconnect the device please follow the guide on Section 12.1.
- ▶ Go to the device scheme tab and select the Network settings button.



FIGURE 34: Enter the network settings

- ▶ Select the Static addressing mode from the combo box

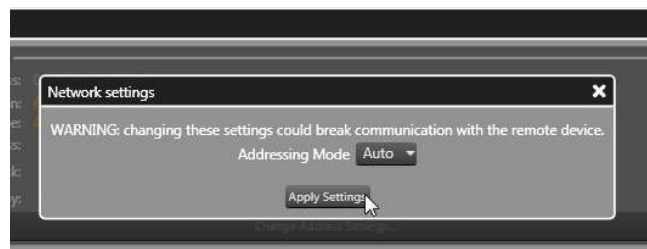

- ▶ Click apply settings button.

- ▶ When done, the device network will restart automatically. About 15 seconds are necessary for the device to reconnect.

6.2.2 Discovery Device*

In order to start remote operation on the device connected to your network, it must be discovered and imported into the Armonía workspace.

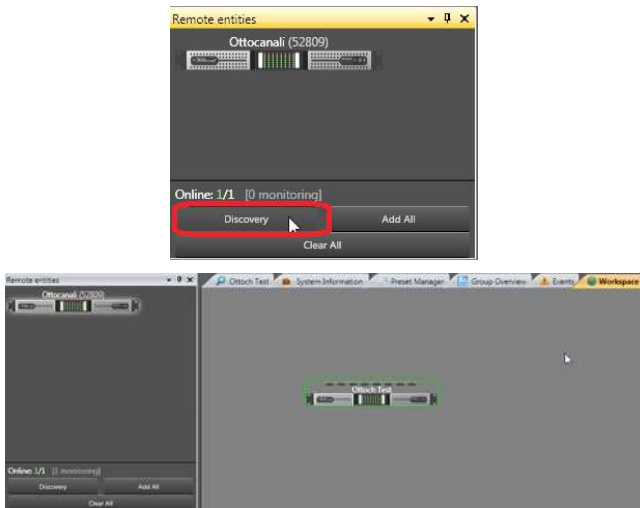

FIGURE 35: A real device controlled by Armonía

To setup the device follow the instructions in the next chapter, referring to the Armonía user manual for basic operations.

6.3 Setup Device*

There are two ways to configure the device, based on your needs and on the availability of the real device. The main difference is that you can either work with virtual devices before going online and send the setup to the units remotely or you can operate on the physical unit directly.

6.3.1 Virtual Device*

If for some reason the devices are not available, configuration must be carried out via virtual devices or a system of virtual devices.

- ▶ Select the device from the models window

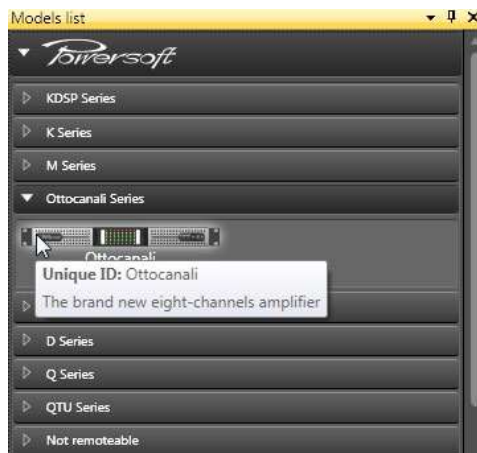

FIGURE 36: Select with left click the virtual unit

- ▶ Drag and drop in the Workspace

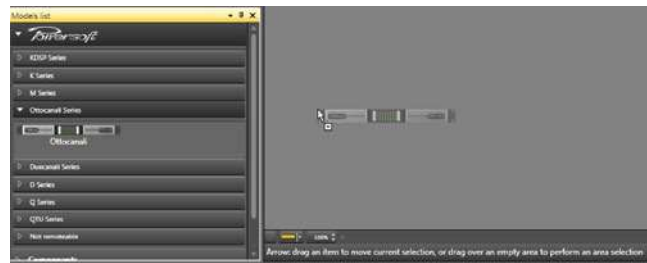

FIGURE 37: Drag&Drop the selected unit in the workspace

- ▶ If you already have a device preset (.pam) you can import it by right clicking

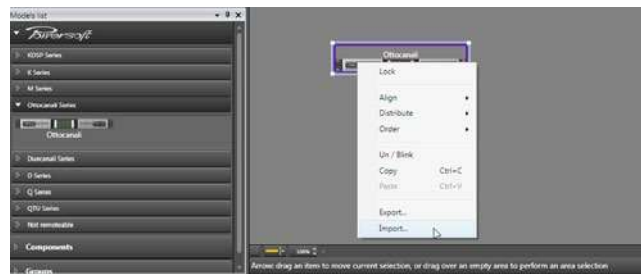

FIGURE 38: Left click to select (the blue rectangle appears) and right click for import

- ▶ You can modify any DSP value following the instructions in Section 6.5

At this point you can save and load the system file (.paw) at a later time. Please refer to the Armonía documentation. If the devices are ready for remote control you can associate the virtual device to the real device. To do so, please follow the instructions in the next section 6.3.2.

6.3.2 Real Device*

Working on the real device remotely is also possible. In this case all changes made to a device are immediately audible.

In order to work on a real device:

- ▶ Connect the device and discover the connected units. (see Section 6.2.2)
- ▶ Drag the remote device into the workspace onto the virtual device

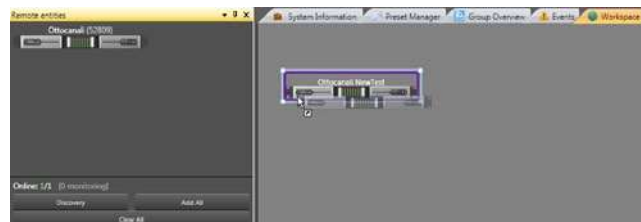

FIGURE 39: Drop the discovered device on the virtual device; when the arrow appears, release the left mouse button.

- ▶ If the internal device setup is different you'll be prompted to select the realignment direction

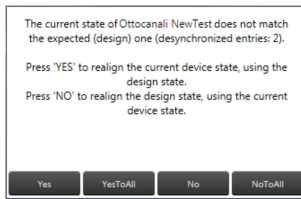

FIGURE 40: Realign window, asking for synchronization

By selecting **YES** the device setup is transmitted from the virtual device to the real device. By selecting **NO** the device setup is transmitted from the real device to the virtual one.

WARNING: by answering "yes" to the realignment question, the Ottocanali device loses data on the selected preset slot.

- ▶ It is now possible to operate on the device. Refer to Section 6.5) for all possible operations.

WARNING: remember that turning off or disconnecting the power plug without saving changes on any internal memory slot leads to data loss. Before turning off, save the data on any internal slot or export to a .pam file.

6.4 File Operations*

There are several import/export possibilities from/to files on an Ottocanali unit. This section contains an explanation of all possible cases.

WARNING: due to the internal structure of the device, some of these file operations can cause a temporary interruption of audio.

6.4.1 Binary Preset File .preset*

Handling of the internal binary preset of an Ottocanali DSP module is possible in the preset tab of the device.



FIGURE 41: Ottocanali, has four DSP modules, recognizable by the left number 1/2/3/4 that represents the slot of every modules.

- ▶ EXPORT, export the actual preset slot to a .preset file.

WARNING: if the actual playing preset wasn't saved before export, the exported binary will be the last stored binary and not the current playing preset.

- ▶ IMPORT, save a .preset file on the selected slot and recall that slot.

WARNING: this leads to a couple of seconds interruption of the audio stream.

WARNING: the data contained in a .preset file irreversibly modifies a preset slot and its internal layout.

6.4.2 Input/Output Curves .icp, .ocp

From the input or output tab of an Ottocanali device, import/export of the current equalization curve is a straightforward procedure.

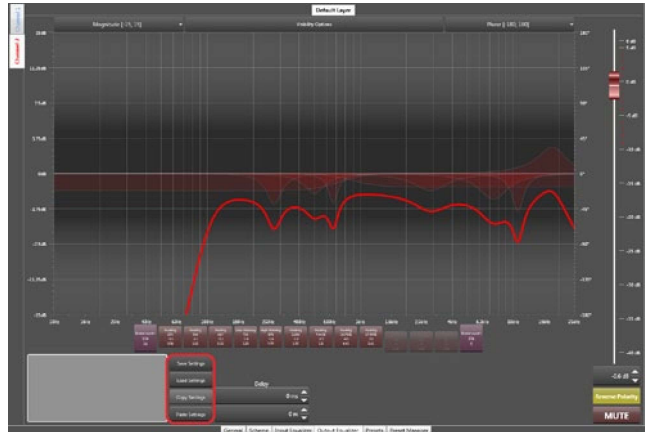

FIGURE 42: The output eq: there are 4 possible choices to handle the curve.

WARNING: all changes will be lost if the preset is NOT stored on board before unplugging the unit from the mains.

6.4.3 Channel Preset .chp*

Import/export of the current playing processing from/to a file is possible by starting from the device's layout.



FIGURE 43: All possible channel operations are available by right clicking on the respective channel.

Imported and/or exported data is:

- ▶ Input eq
- ▶ Output eq
- ▶ Limiters

WARNING: all changes will be lost if the preset is NOT stored on board before unplugging the unit from the mains.

NOTE: importing channel preset files doesn't modify the internal structure of a device and therefore doesn't lead to an audio interruption

6.4.4 Device Preset File .pam*

The preset file allows to import/export entire dumps of the device. An exported .pam file allows to completely replicate the DSP process on another device. In order to import/export a .pam file:

- ▶ Select the device (a blue rectangle will appear)
- ▶ Right click on the selected device
- ▶ Click on import/export

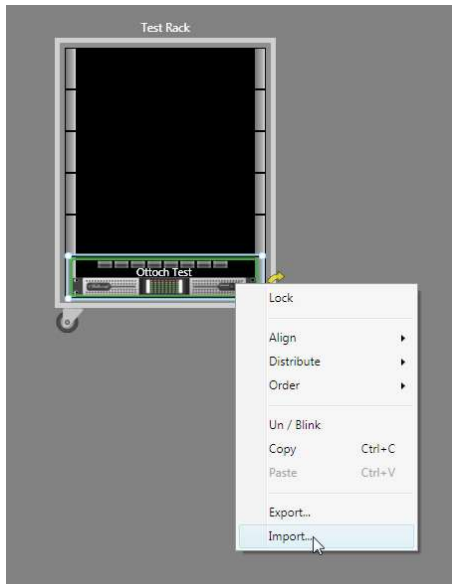

FIGURE 44: The .pam import/export operation from the workspace. Note the blue rectangle on the selected device.

When importing a .pam file you'll be prompted for a decision on the realignment policy to adopt.

By selecting **yes**, the device setup is transmitted from the virtual device to the real device. By selecting **no**, the device setup is transmitted from the real device to the virtual device.

WARNING: importing a .pam file leads to a short interruption of the audio stream.

WARNING: importing a .pam file overwrites the current preset slot on the device. Any previous data on the slot will be erased.

6.4.5 System File .paw*

Saving or opening a systems file permits the storage of the entire processing of the current device imported in the workspace. For more information on system configuration, please refer to the Armonía manual.

The save operation may be seen as a large .pam export of the entire device; on the other hand, opening a .paw file is equivalent to performing a large .pam import on multiple devices. The user will be prompted for multiple realignment decision on any desynchronized devices.

If the question is answered with:

- ▶ **YES**, the device specified in the window will be aligned to the data in the .paw file.
- ▶ **YES TO ALL**, all the devices will be aligned to the data in the .paw file.
- ▶ **NO**, the device specified in the window will **NOT** be aligned to the data in the .paw file but the data will be reloaded from the device.
- ▶ **NO TO ALL**, all the devices will **NOT** be aligned to the data in the .paw file but the data will be reloaded from the devices.

WARNING: during import or preset manager operations the save .paw function is disabled.

6.5 DSP Remote Operations*

WARNING: due to the internal structure of the system some of the following file operations can lead to a short audio interruption.

WARNING: all changes will be lost if the preset is NOT stored on board before unplugging the unit from the mains.

6.5.1 Routing*

It's possible to select an independent routing for any channel pair. In order to change the routing it is necessary to follow the steps below:

- ▶ Enter the device UI and select the scheme tab.
- ▶ Click on one of the 4 input routing button. (One for any modules).



FIGURE 45: The routing section.

- ▶ Select the routing between the 4 possible choices.

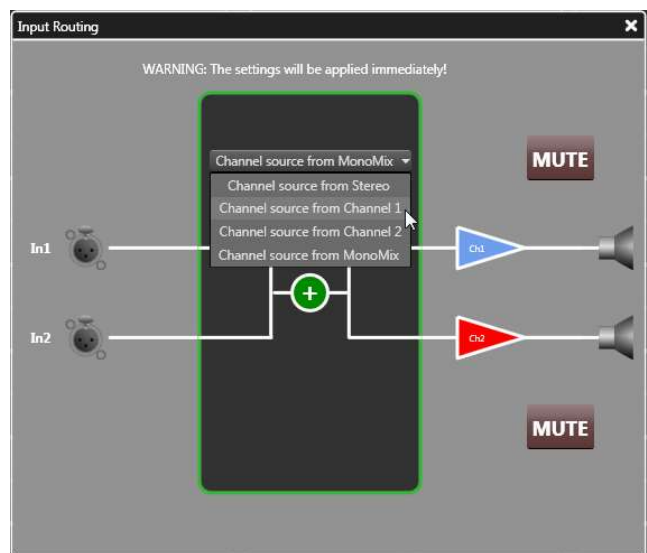

FIGURE 46: Four possible selections.

6.5.2 Input Eq.*

The Input Eq. is intended for system operations. The input eq provides a range of biquad filters that can act as any generic IIR filter. Refer to Section 5.11.3 for more information. From the input eq page, the frequency response of each channel can be adjusted

in several ways. Discrete time delays can also be inserted. The presence of every input eq used in the device layout is reported on the tabbed channel on the bottom left hand side of the screen. The frequency response curves, together with other View items, are color coded: light blue for channel 1, red for channel 2, light green for channel 3, yellow for channel 4, dark blue for channel 5, purple for channel 6, dark green for channel 7 and orange for channel 8. Every channel allows regulation of filters, mute, gain, delay and polarity. The frequency response (and/or phase response) curve displayed is always obtained as the combined response of all currently active filters.

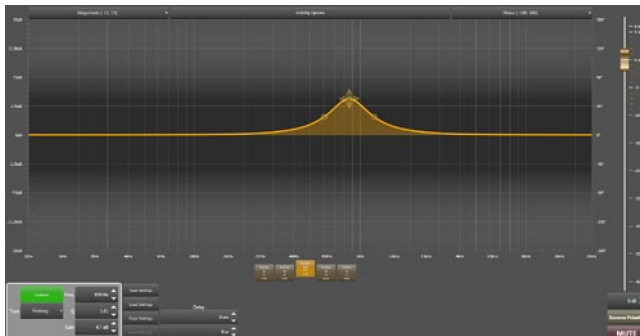

FIGURE 47: The input eq layer.

6.5.3 Output Eq.*

This page's general appearance is similar to that of the Input Equalizer page, but presents several important differences. The Output Eq. curve the amplifier employs is meant to be created from the speaker manufacturer's data for the particular loudspeaker cabinets or arrays the amplifier will be driving. It provides a range biquad filter that can act as crossover or generic IIR filter. Refer to Section 5.11.3 for more information. From this page, the frequency response of each channel can be adjusted in several ways. Discrete time delays can also be inserted. The presence of every output eq. present in the device layout is reported on the tabbed channel on the bottom left hand side of the screen. The frequency response curves, together with other View items, are color coded: light blue for channel 1, red for channel 2, light green for channel 3, yellow for channel 4, dark blue for channel 5, purple for channel 6, dark green for channel 7 and orange for channel 8. Every channel allows regulation of filters, mute, gain, delay and polarity. The displayed frequency response (and/or phase response) curve is always obtained as the combined response of all currently active filters.

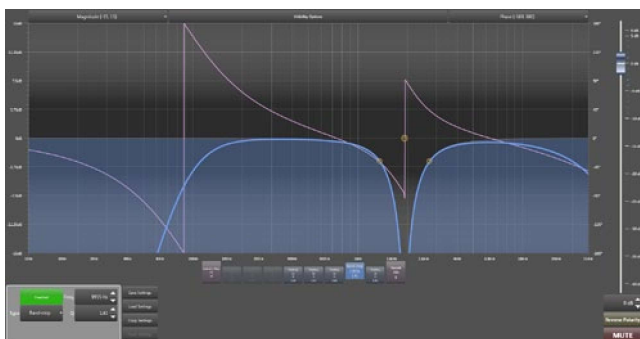

FIGURE 48: The output eq layer.

6.5.4 Limiters*

The function of the limiters is to protect voice coils from burning out due to excess power being delivered over an extended period of time or from excessively large signal peaks by limiting the maximum output voltage of the amplifier. The limiter window is accessible by clicking on the limiter block in the device layout view. Every channel limiter is color coded: light blue for channel 1, red for channel 2, light green for channel 3, yellow for channel 4, dark blue for channel 5, purple for channel 6, dark green for channel 7 and orange for channel 8.

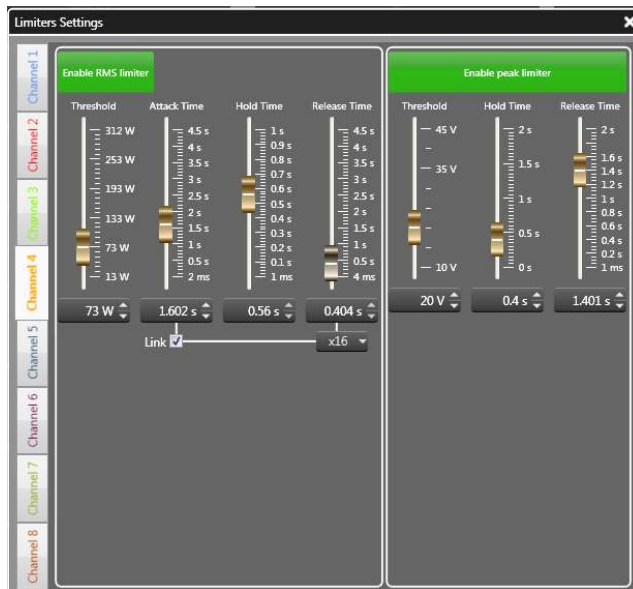

FIGURE 49: The limiters window.

6.5.4.1 RMS Limiter*

Electromechanical transducers are highly inefficient; as such they transform a significant amount of input power into heat. The function of the RMS limiter is to protect the voice coils of speaker drivers from burning out due to excess power being delivered over an extended period of time. The RMS limiter is set by selecting a desired maximum power value but acts by limiting output voltage; by applying Ohm's law with a fixed reference 8 Ohm load, the output voltage level corresponding to the desired maximum output power value is calculated as the square root of power times the load resistance (8 Ohm). It is possible to set the values of:

- ▶ Threshold in Watts, with respect to an 8 Ohm load.
- ▶ Attack time is the time between the moment the output voltage exceeds the threshold and the moment of the onset of the limiting action.
- ▶ Hold time is the length of time during which the limiting action is maintained before the gain returns to normal levels because the output voltage drops below the threshold level.
- ▶ Release time is the length of time over which the limiting action is reduced and the gain is returned to normal following the drop of the output voltage below the threshold level.

6.5.4.2 Peak Limiter*

The function of the peak limiter is to protect voice coils from excessively large signal peaks by limiting the maximum output

voltage of the amplifier. It's possible set the values of:

- ▶ Threshold in Volts: the amplifier max output voltage level corresponding to the maximum displacement of the speaker diaphragm.
- ▶ Hold time: the time over which the limiting action is maintained before the gain level is returned to normal after the output voltage drops below the threshold.
- ▶ Release time: the length of time over which the limiting action is reduced and the gain is returned to normal following the drop of the output voltage below the threshold level.

6.5.5 Locking*

The locking mechanism allows the user to prevent changes to a whole preset or a part of a preset. The locking interface is divided in DSP module(s) and macro processing section (Refer to Section 5.11.4 for further information on the logical data section). Every module needs to be locked separately; the lock status is preserved with the import/export from/to file and copy/paste operations. In order to lock/unlock an entire module or parts of a module:

- ▶ Access the locking interface



FIGURE 50: Click on the preset locking button in the layout tab of the device.

- ▶ If the module you want to modify is already locked, you need to insert the unlocking password for that module.

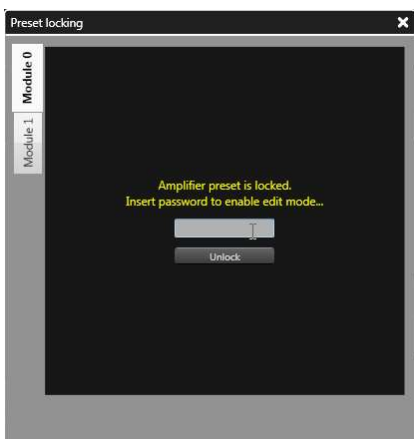
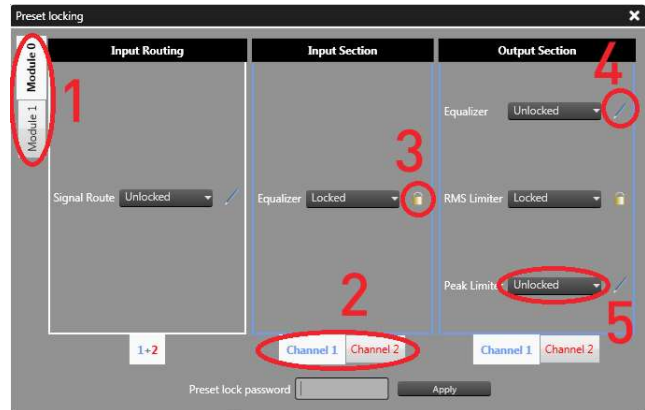

FIGURE 51: Insert the unlock password.

- ▶ A number of operations are allowed here. Please refer to the figure below for an explanation of the various functions and symbols.



1. Select Module
2. Select channel for the macro property.
3. A padlock indicates a locked property
4. A pencil indicates a writable property
5. The combo box allows to change the single macro property.

- ▶ In order to lock the module with the selected layout, insert the locking password and press the button Apply.

6.5.6 On Board Preset Operations*

The preset tab of all Ottocanali devices allows to handle the internal binary preset of an Ottocanali DSP module.

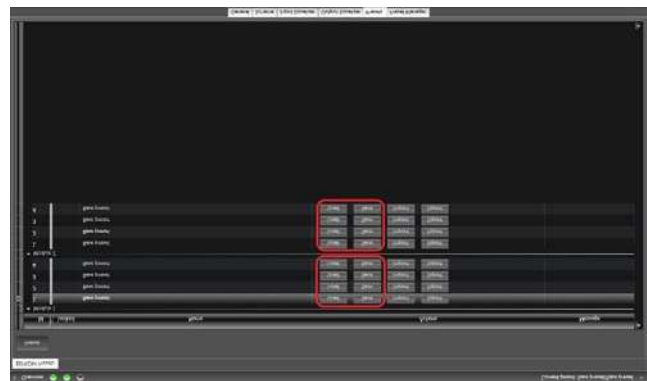

FIGURE 52: The Ottocanali has 4 DSP modules; all 4 slots must be recalled in 4 separate operations.

- ▶ **SAVE**, allows saving of the current DSP processing on the selected preset slot.
- ▶ **LOAD**, recalls the selected preset slot.

WARNING: (re)loading a preset causes a couple of seconds of interruption of the audio stream.

6.5.7 Copy & Paste Operations*

Any paste operation does not affect the DSP binary and its corresponding structure; therefore, applying data with the paste command does not lead to audio interruption.

WARNING: any data pasted into a device needs to be saved in a preset slot, otherwise any turn off/on cycle leads to data loss.

6.5.7.1 Input/Output Eq Curves*

In order to copy/paste an eq curve, copy the source curve with the dedicated copy function and paste to the destination eq, with the dedicated paste function.



FIGURE 53: The output eq. There are 4 possible alternatives to handle the curve.

WARNING: all changes will be lost if the preset is NOT stored on board before unplugging the unit from the mains.

6.5.7.2 Channels*

Copy and paste of the current playing processing setup from/to the clipboard is possible from the device layout.



FIGURE 54: All possible channel operations are available by right clicking on the corresponding channel.

Data that can be copied and pasted:

- ▶ Input eq
- ▶ Output eq
- ▶ Limiters

WARNING: all changes will be lost if the preset is NOT stored on board before unplugging the unit from the mains.

6.5.7.3 Workspace*

The copy/paste function from an Ottocanali device to another Ottocanali device is limited to the same family device (e.g. source Ottocanali, target Duecanali).

WARNING: all changes will be lost if the preset is NOT stored on board before unplugging the unit from the mains.

7 Protection

In order to protect your device and your speakers from accidental damage, the Ottocanali amplifier includes an extensive automatic protection system. In the following sections, potentially dangerous scenarios and the amplifier's corresponding protective response are explained in detail.

7.1 Turn On/Turn Off Muting

Class D amplifier may cause severe speaker damage at power up due to the high voltage levels at the output stage. In order to avoid this, the outputs are muted for less than 2 seconds after turn on. Similarly, turning off the amplifier can cause the same problem: outputs are muted immediately at turn off.

7.2 Short Circuit Protection

Short circuits or very low impedance loads may destroy the output stage of any amplifier. In order to protect the amplifier from the dangerously high current surges arising from accidental output short circuits or low impedance loads, the Ottocanali blocks channel activity when the current drawn from the load rises above a set value.

7.3 Thermal Protection

All Powersoft amplifiers have variable speed fans to assist cooling. If for some reason the cooling system can't dissipate the produced heat correctly, a thermal protection system is automatically activated to avoid permanent damages. Every channel pair of the Ottocanali has a temperature sensor on the output stage heat sink. Two different protection strategies are implemented depending on the severity of the overheating. In order to protect internal components, the amplifier may automatically reduce output power until the internal temperature returns to safe levels.

7.3.1 Thermal Warning

If the heat sink temperature reaches 70°C the front panel yellow LEDs turn on to warn the user of a potentially dangerous thermal event.

7.3.2 Thermal Shutdown

If the heat sink temperature rises above 80°C, the thermal sensing circuitry will mute each power section of each channel. All the red front panel LEDs light on to indicate thermal halt and a thermal event switch toggles all the alarm outputs at the back of the amplifier. Only after the heat sink has cooled down to below 70°C the channels will automatically unmute, the LEDs turn off and the rear switch toggles again.

7.4 DC Fault Protection

In order to protect your speakers from mechanical damage caused by a DC signal coming from the amplifier's output, a DC detection circuit is placed between the Ottocanali's output stage and power supply. If a DC signal or excessive subsonic energy appears at a

channel output an instantaneous protection circuit will mute the compromised channel pair.

7.5 Input/Output Protection

Interference protection is implemented in the Ottocanali to limit out of band noise carried by the input lines. Disturbing frequencies can interact with the output stage, causing unpredictable amplifier behavior. A filtering system is used to stop infrasonic and VHF signals from entering the signal path.

7.6 Check Line Integrity and Impedance Measurement*

The integrity monitor tools allow the end user to program and test the integrity of the input and/or output line. The input test is based on the detection of a pure tone (generated by an external tone generator) on any input lines. The output test is based on the measurement of the impedance at a well defined frequency. The amplifier can generate a pure tone and measure the voltage and the current at the generated tone frequency. It is therefore possible to recalculate the impedance at that specific frequency. When an alarm is detected the user can be informed of the event via software or directly from the amplifier. Bear in mind that there is one generator for each channel pair.

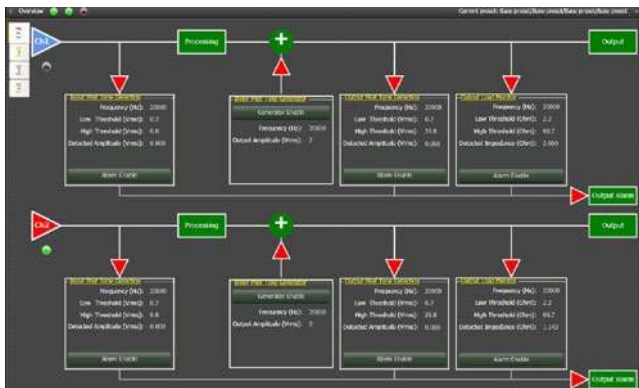

FIGURE 55: GPO tab

This page can be found inside the Amplifier view, tab GPO. Slightly below each triangle containing the channel number is a green LED that is lighted when a BatFormer is plugged in that specific channel. When the LED is off, no BatFormer has been installed on that channel. In the figure above, for example, channel 2 has a BatFormer installed, while channel 1 does not. BatFormer presence can also be verified in the general Armonía overview window. A lit green LED underneath the single channel will confirm that a BatFormer is installed. In the following figure no BatFormers have been installed.



FIGURE 56: General overview window

7.6.1 Programing Interface and Alarm Blocks Overview*

The input and the output section can be programmed separately; however, they are logically divided by the processing section. This means that the input tone can be filtered out, avoiding feeding it to the output section. When an alarm triggers, this is reported in Armonía in the following way: - One Armonía event (if selected) will be activated - In the GPO page the blocks with an active alarm become red.

On the amplifier side an alarm will be reported as a blinking red LED in the front panel and an alarm switches at the back of the amplifier.

7.6.2 Input Pilot Tone Detection*

The input tone detection can measure the integrity of any input line feeding signal into the amplifier. This detector can measure a tone applied by an external generator. In the GPO overview the input pilot tone block appears as seen in the figure below.

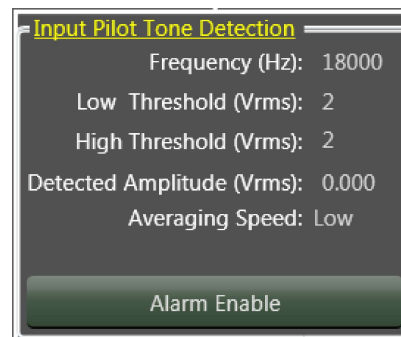

FIGURE 57: This control shows the threshold, the frequency and the measured amplitude of the tone.

NOTE: suggested frequency values for the tone generator are between 20 kHz and 22 kHz with the paying close attention to cutting-off the tone before the output section.

Clicking the yellow label will open the following window:

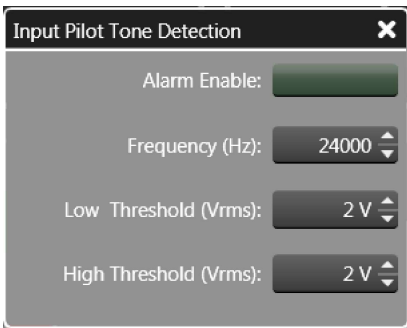

FIGURE 58: This window allows programming of the alarm parameters:

- ▶ The frequency of the tone that has to be detected (range 20 Hz - 22 kHz, step of 10 Hz)
- ▶ The minimum threshold value that has been detected (range 0 Vrms - 1 Vrms, step of 10 mVrms)
- ▶ The maximum threshold value that has been detected (range 0 Vrms - 1 Vrms, step of 10 mVrms)
- ▶ The alarm enable button

7.6.3 Output Pilot Tone Detection*

The output tone detection can measure the presence of the tone generated by an external generator or an internal one. In the GPO overview the output pilot tone block appears as in the figure below

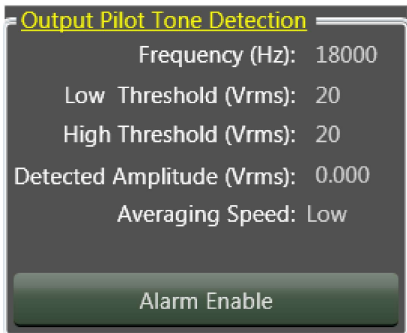

FIGURE 59: This control shows the threshold, the frequency and the measured amplitude of the tone.

Clicking the yellow label will open the following window

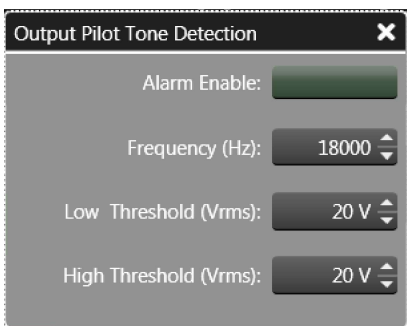

FIGURE 60: This window allows programming of the alarm parameters:

- ▶ The frequency of the tone that has to be detected (range 20 Hz - 22 kHz, step of 10 Hz)
- ▶ The minimum threshold value that has been detected (range 0 Vrms - 30 Vrms, step of 0.1 Vrms)
- ▶ The maximum threshold value that has been detected (range

0 Vrms - 30 Vrms, step of 0.1 Vrms)

- ▶ The alarm enable button

7.6.4 Inner Pilot Tone Generator*

The inner tone generator allows the user to generate a tone that can be used to check the integrity of the output line. This tone must lie outside the speaker's range limits to avoid hearing it in the output.

NOTE: Typically a good value is between 20/40 Hz (20/22kHz if BatFormer is used) with an amplitude between 2 and 4 V.

The tone generator block appears as in the figure below.



FIGURE 61: Clicking the yellow label will open the following window

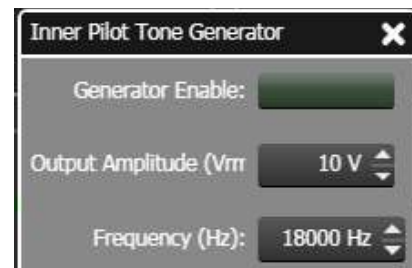

FIGURE 62: This window allows programming of the generator parameters:

- ▶ The frequency of the tone that has to be generated (range 20 Hz - 22 kHz, step of 10 Hz)
- ▶ The minimum threshold value that has been detected (range 0 Vrms - 20 Vrms, step of 1 Vrms)
- ▶ The alarm enable button

7.6.5 Output Load Monitor*

The output Load Monitor allows to detect the impedance load at a certain frequency. The high resolution algorithm allows accurate measurements.

The control block appears as in the following figure

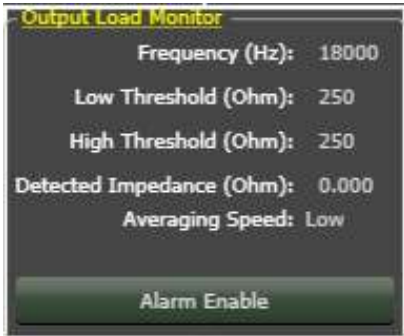

FIGURE 63: This control shows the current values of the block.

Clicking the yellow label will open the following window

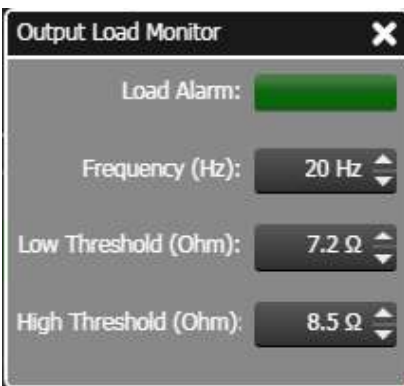

FIGURE 64: This window allows programming of the alarm parameters:

- ▶ The frequency of the tone that has to be detected (range 20 Hz - 24 kHz, step of 10 Hz)
- ▶ The minimum impedance threshold value allowed (range 0 Ω - 1000 Ω, step of 0.1 Ω)
- ▶ The maximum impedance threshold value allowed (range 0 Ω - 1000 Ω, step of 0.1 Ω)
- ▶ The alarm enable button

8 User Maintenance

8.1 Cleaning

Before attempting to clean any part of the amplifier, first disconnect the AC main source. Use a soft cloth and mild non-abrasive solution to clean the faceplate and chassis.

WARNING! Never let any liquid reach the internal parts of the amplifier.

8.2 Service

There are **no user-serviceable** parts in your amplifier. Refer servicing to qualified technical personnel.

In addition to having an in-house service department, Powersoft supports a network of authorized service centers. If your amplifier needs repair contact your Powersoft dealer (or distributor). You can also contact the Powersoft Technical Service department to obtain the location of the nearest authorized service center.

8.3 Dust Removal

In dusty environments, the front side air filters clog with dust after prolonged use. The dust gathered in the filters will interfere with cooling. You may use compressed air to remove the dust from filters. To remove air filters please refer to the front panel removal procedure (5.2). Air filter cleaning should be scheduled according to the dust levels in the amplifier's operating environment.

9 Warranty

Product Warranty:

POWERSOFT guarantees its manufactured products to be free from defective components and factory workmanship for a period of 48 (forty eight) months, starting from the date of purchase printed on Powersoft's (or any of its Authorized Dealer's) invoice to the end customer. All warranty repairs and retrofits must be performed at POWERSOFT facilities or at an Authorized Service Center at no cost for the purchaser. Warranty exclusion: POWERSOFT's warranty does not cover product malfunctioning or failure caused by: misuse, abuse, repair work or alterations performed by non-authorized personnel, incorrect connections, exposure to harsh weather conditions, mechanical damages (including shipping accidents), and normal wear and tear. POWERSOFT will perform warranty services provided that the product is not damaged during transportation.

Return of Goods:

Goods can be returned to POWERSOFT only after they have been granted a Return Merchandise Authorization (RMA) number to be attached to the external packaging. POWERSOFT (or its Authorized Service Center) has the right to refuse any returned good without a RMA number.

Repair or replacement:

POWERSOFT reserves the right to repair or replace any defective goods covered by product warranty at its sole discretion and as it deems best.

Cost and responsibility of transport:

The purchaser (or end user/customer) is solely responsible for all transportation costs and risks associated with sending warranty covered goods to POWERSOFT or its Authorized Service Center. POWERSOFT will assume full responsibility and cover all costs incurred to send the goods back to the purchaser (or end user/customer).

10 Assistance

Even though most product malfunctioning can be solved at your premises through Powersoft Customer Care or your direct knowledge, occasionally, due the nature of the failure, it might be necessary to return defective products to Powersoft for repair. In the latter case, before shipping, you are kindly asked to follow step by step the procedure described below: Obtain the "Defect Report Form" by contacting our Customer Care Department via email: service@powersoft.it or download the "Defect Report Form".

Fill out one "Defect Report form" for each returned item (the form is an editable tab guided document) and save as your name, amp model and serial Number (for example: `distributorek10sn17345.doc`) providing all required information except the RMA code/s and send it to service@powersoft.it for Powersoft approval.

In case of defect reports approved by the Powersoft Customer Service Representative you will receive an RMA authorization code (one RMA code for each returning device). Upon receiving the RMA code you must package the unit and attach the RMA code outside the pack, protected in a waterproof transparent envelope so it is clearly visible.

All returning items must be shipped to the following address:

Powersoft srl
Via Enrico Conti, 13-15
50018 Scandicci (FI) Italy

In case of shipment from countries NOT belonging to the European Community make sure you have also followed the instructions described in the document available for download at the following link:

http://www.powersoft-audio.com/en/component/docman/doc_download/298-temporary-export-import-procedure.html?Itemid=111

TEMPORARY EXPORTATION / IMPORTATION PROCEDURE

Thank you for your understanding and cooperation and continued support as we work to improve our partnership.

II Technical Specifications

II.1 Ottocanali I204 DSP+ETH

General						
Number of channels	8					
	Mono-bridgeable per channel pair. Optional BatFormers® (transformers) per channel for 70 V or 100 V constant voltage operation; serial operation of channel pairs equipped with BatFormers for higher voltage possible.					
Output power	8-channel mode			mono-bridged mode		
EIAJ Test Standard, 1 kHz, 1% THD	4 Ω / Ch	8 Ω / Ch	70 V ¹⁾	100 V ¹⁾	8 Ω / Ch pair	16 Ω / Ch pair
	150 W	80 W	125 W	130 W	300 W	150 W
Max output voltage	37 V _{peak}		77 V _{peak}	151 V _{peak}	76 V _{peak}	
Max output current	15 A _{peak}		4.8 A _{peak}	3.4 A _{peak}	15 A _{peak}	
AC Mains Power						
Power supply	Universal, regulated switch mode with PFC (Power Factor Correction)					
Operating voltage / Inrush current	100 V - 240 V ± 10%, 50/60 Hz / < 5 A _{RMS}					
Power factor cos (φ)	> 0.8 when > 500 W					
Consumption / current draw	@ 230 V			@ 115 V		
Energy Save on	14.6 W		0.34 A		13.9 W	0.26 A
Energy Save off	21.2 W		0.36 A		20 W	0.33 A
1/8 of max power @ 4 Ω	223 W		1.24 A		224 W	1.99 A
1/4 of max power @ 4 Ω	417 W		2.00 A		423 W	3.70 A
Thermal						
Environmental operating temperature	0° - 45° C / 32° - 113° F					
Thermal dissipation	Fan, continuously variable speed, temperature controlled front to rear airflow					
	230 V			115 V		
Energy Save on	31.71 BTU/h		8.00 kcal/h		29.66 BTU/h	7.48 kcal/h
Energy Save off	53.20 BTU/h		13.42 kcal/h		50.12 BTU/h	12.64 kcal/h
1/8 of max output power @ 4 Ω	248.93 BTU/h		62.78 kcal/h		252.34 BTU/h	63.64 kcal/h
1/4 of max output power @ 4 Ω	398.97 BTU/h		100.62 kcal/h		419.41 BTU/h	105.78 kcal/h
Audio						
Gain	lo-Z		hi-Z @ 70 V		hi-Z @ 100 V	
	32 dB		41 dB		44 dB	
Frequency response	20 Hz - 19.5 kHz		57 Hz - 16 kHz		57 Hz - 15.5 kHz	
S/N ratio (amplifier section)	> 92 dBA		> 92 dBA		> 92 dBA	
Crosstalk separation	> 61 dB		> 61 dB		> 61 dB	
Input sensitivity @ 8 Ω	20 Hz - 20 kHz (1 W @ 8 Ω, ± 0.5 dB, or 32/65 W @ 70/100 V, ± 2.5 dB)					
Max input level	0.63 V / -1.79 dBu					
Input impedance	10 kΩ balanced					
THD+N / SMPTE IMD / DIM100 IMD	typ. < 0.05% ²⁾					
Slew rate	12 V/μs @ 8 Ω, input filter bypassed					
Damping factor	> 500 @ 20-200 Hz (lo-Z)					
DSP						
AD/DA converters	AD: 24bit/48kHz 100dB SNR, THD < 0.02% (20 Hz - 20 kHz); DA: 24bit/48kHz 102dB SNR, THD < 0.02% (20 Hz - 20 kHz)					
Delay for time alignment	Up to 16 ms per output					
Crossover filters	Butterworth, Linkwitz-Riley, Bessel, 6-48 dB/oct					
Input/Output equalizer	5 (input) / 8 (output) filters max (filter types: parametric, hi/lo shelving, hi/lo pass, band pass, band stop, all pass)					
Limiters	Peak, RMS					
Pilot Tone Detection and Output Load Monitor						
Input voltage and frequency	0 V _{RMS} - 1 V _{RMS} in steps of 10 mV _{RMS} ; 20 Hz - 22 kHz in steps of 10 Hz					
Output voltage and frequency	0 V _{RMS} - 30 V _{RMS} in steps of 10 mV _{RMS} ; 20 Hz - 22 kHz in steps of 10 Hz					
Output load impedance	0 Ω - 1000 Ω in steps of 0.1 Ω					
Front Panel						
Indicators	7 multifunction LEDs per channel: 4 x green, 2 x yellow, 1 x red					
Controls	Pushbutton enables 24 V DC at back PWS OUT connector (can also toggle LINE/AUX inputs), 8 output attenuators, energy save mode activation (per channel pair) DIP switch, DSP preset selection					
Maintenance	Dust filter foam behind frontal silver colored panels					
Rear Panel						
Audio signal input connectors	2 x 12 pin Phoenix MC 1.5/12-ST-3.81 1803675					
Loudspeaker output connectors	16 pin Phoenix MSTB 2.5/16-ST-5.08 1757158					
Fault alarm connectors	12 pin Phoenix MC 1.5/12-ST-3.81 1803675					
Aux command (triggering aux inputs) and aux voltage for remote on/off switching	4 pin Phoenix MC 1.5/4-ST-3.81 1803594					
Aux front switch enabling and external 24 V DC (0.2 A) auxiliary supply	4 pin Phoenix MC 1.5/4-ST-3.81 1803594					
Network data port Ethernet	1 x RJ45 with activity LED with 2 rotary address switches					
AC mains	IEC C13 16 A connector, AC mains cord with 3-pin plug 15 A for US, IEC Schuko 16 A for every other nation					
Construction						
Dimensions	W 483 mm / 19", H 44.45 mm / 1.75" / 1 RU, D 360 mm / 14.2"					
Chassis	Steel safety/dust covers; 1 mm steel front panel, side reinforcement, rear support; 1 mm steel top & bottom lid, rear panel					
Weight	5-11 kg / 11-24.3 lb, depending on number of BatFormers installed					

1) With BatFormer® inserted per channel.

2) Guaranteed by design.

Data is subject to change without notice.

© 2012 Powersoft • All rights reserved.

11.2 Ottocanali I204

General						
Number of channels	8					
	Mono-bridgeable per channel pair. Optional BatFormers® (transformers) per channel for 70 or 100 V constant voltage operation; serial operation of channel pairs equipped with BatFormers for higher voltage possible.					
Output power	8-channel mode			mono-bridged mode		
EIAJ Test Standard, 1 kHz, 1% THD	4 Ω / Ch 150 W	8 Ω / Ch 80 W	70 V ¹⁾ 125 W	100 V ¹⁾ 130 W	8 Ω / Ch pair 300 W	16 Ω / Ch pair 150 W
Max output voltage	38 V _{peak}		115 V _{peak}	165 V _{peak}	76 V _{peak}	
Max output current	15 A _{peak}		8 A _{peak}	4.5 A _{peak}	15 A _{peak}	
AC Mains Power						
Power supply	Universal, regulated switch mode with PFC (Power Factor Correction)					
Operating voltage / Inrush current	100 V - 240 V ± 10%, 50/60 Hz / < 5 A _{RMS}					
Power factor cos (φ)	> 0.9 when > 500 W					
Consumption / current draw	@ 230 V			@ 115 V		
Energy save	9.3 W	0.30 A	8.7 W	0.21 A		
Idle	15.6 W	0.33 A	14.7 W	0.27 A		
1/8 of max power @ 4 Ω	223 W	1.24 A	224 W	1.99 A		
1/4 of max power @ 4 Ω	417 W	2.00 A	423 W	3.70 A		
Thermal						
Environmental operating temperature	0-45° C / 32-113° F					
Thermal dissipation	Fan, continuously variable speed, temperature controlled front to rear airflow					
	230 V			115 V		
Energy save	31.71 BTU/h	8.00 kcal/h	29.66 BTU/h	7.48 kcal/h		
Idle	53.20 BTU/h	13.42 kcal/h	50.12 BTU/h	12.64 kcal/h		
1/8 of max output power @ 4 Ω	248.93 BTU/h	62.78 kcal/h	252.34 BTU/h	63.64 kcal/h		
1/4 of max output power @ 4 Ω	398.97 BTU/h	100.62 kcal/h	419.41 BTU/h	105.78 kcal/h		
Audio						
Gain	lo-Z 32 dB		hi-Z @ 70 V 41 dB		hi-Z @ 100 V 44 dB	
Frequency response	20 Hz - 20 kHz		55 Hz - 10.25 kHz		55 Hz - 16.25 kHz	
S/N ratio (amplifier section)	> 105 dB		> 110 dB		> 105 dB	
Crosstalk separation	> 60 dB		> 55 dB		> 55 dB	
Input sensitivity @ 8 Ω	20 Hz - 20 kHz (1 W @ 8 Ω, +/-0.5 dB, or 32/65 W @ 70/100 V, +/-2.5 dB)					
Max input level	0.63 V / -1.79 dBu					
Input impedance	10 KΩ balanced					
THD+N / SMPTE IMD / DIM100 IMD	typ. < 0.05% ²⁾					
Slew rate	50 V/μs @ 8 Ω, input filter bypassed					
Damping factor	> 500 @ 20-200 Hz (Lo-Z)					
Front Panel						
Indicators	7 multifunction LEDs per channel: 4 x green, 2 x yellow, 1 x red					
Controls	Pushbutton enables 24V DC at back PWS OUT connector (can also toggle LINE/AUX inputs), 8 output attenuators, energy save mode activation (per channel pair) DIP switch					
Maintenance	Dust filter foam behind frontal silver colored panels					
Rear Panel						
Audio signal input connectors	2 x 12 pin Phoenix MC 1.5/12-ST-3.81 1803675					
Loudspeaker output connectors	16 pin Phoenix MSTB 2.5/16-ST-5.08 1757158					
Fault alarm connectors	12 pin Phoenix MC 1.5/12-ST-3.81 1803675					
Aux command (triggering aux inputs) and aux voltage for remote on/off switching	4 pin Phoenix MC 1.5/4-ST-3.81 1803594					
Aux front switch enabling and external 12V auxiliary supply	4 pin Phoenix MC 1.5/4-ST-3.81 1803594					
AC mains	IEC C13 I6A connector; AC mains cord with 3-pin plug I5A for US, IEC 'Schuko' I6A for every other nation					
Construction						
Dimensions	W 483 mm / 19", H 44.45 mm / 1.75" / 1 RU, D 360 mm / 14.2"					
Weight	5-11 kg / 11-24.3 lbs, depending on number of BatFormers					
Chassis	Steel safety/dust covers; 3 mm steel front panel, side reinforcement, rear support; 1 mm steel top & bottom lid, rear panel					

1) With BatFormer® inserted per channel.

2) Guaranteed by design.

Data is subject to change without notice.

© 2012 Powersoft • All rights reserved.

12 Appendix

Through Armonía Pro Audio Suite you can easily set the IP configuration of your Ottocanali DSP+ETH as long as it is in DHCP or is configured with a static IP on the same Armonía subnet. It may happen that a static IP in a different subnet with respect to Armonía has been assigned to your Ottocanali DSP+ETH amplifier (i.e. 10.0.x.y versus 169.254.x.y); if this is the case Armonía does not recognize the amplifier. You have to reset the IP configuration of your amplifier.

In order to reset the IP configuration of your Ottocanali DSP+ETH amplifier outside the Armonía environment, follow next instruction.

12.1 Setting An IP Policy On ADAU Based Devices With An External Lantronix Tool*

Ottocanali DSP+ETH amplifiers come with one rear RJ45 port for remote device communication, using the IP layer and the UDP protocol. Factory default settings are DHCP/AutoIP, but a fixed IP policy can also be adopted.

12.1.1 Set IP configuration*

Adau based devices can be set up with a static IP (or any other IP policy) with an external software programmer provided by Lantronix™. In order to set up the IP address please follow the following steps:

1. Download and install the DeviceInstaller™ software from the Lantronix Web Site on your PC. Please refer to Lantronix documentation.
2. Connect the device to your PC
3. Shutdown any M Series client (Armonía or third-party client).
4. Launch the program: it should automatically scan your network. If not, manually initiate the scan by clicking the Search button.

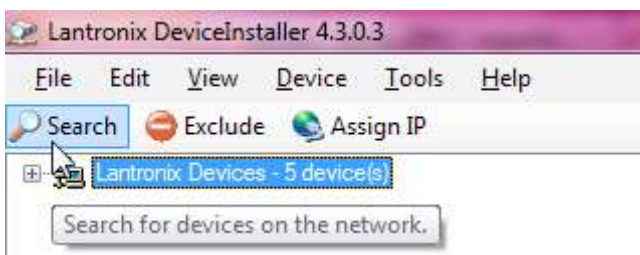

NOTE: Due to the fact that the Lantronix configurator uses the Ethernet layer no IP set up is necessary.

All the available Lantronix-based devices should appear (see FIGURE 71). Please note that devices that are not compatible with the IP network mask of your network interface should appear too due to the fact that the Lantronix Configurator uses the Ethernet stack.

WARNING: Make sure that the only connected Lantronix-based devices are Ottocanali units. Any third-party device (e.g. printers) that are equipped with a Lantronix unit are visible with this software.

Powersoft will be not responsible for any damage suffered by third-party products equipped with Lantronix hardware.

12.1.2 Static IP*

1. Select the device whose IP address policy you want to set and press the button Assign IP (see FIGURE 72)
2. Follow the Device Installer wizard. Any kind of IP policy can be set.

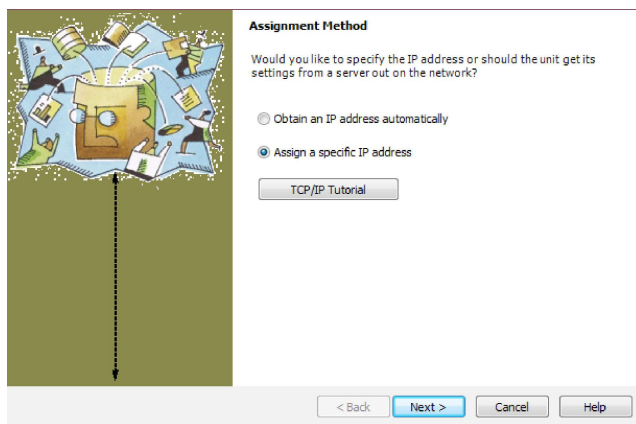

FIGURE 65: Select assign specific IP and click next.

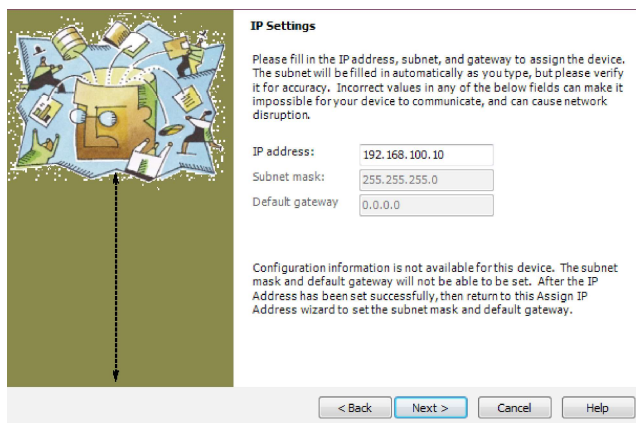

FIGURE 66: Select IP address and subnet mask compatible with your PC. Specifying the gateway address is not mandatory. Click next.

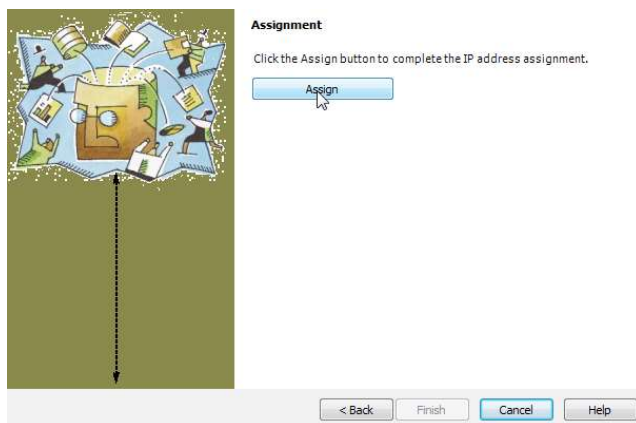

FIGURE 67: When done press the Assign button.

12.1.3 Revert From Static IP*

If for any reason re-programming the IP address or the IP policy of your unit should be necessary, follow the instructions in the previous chapter and make a different selection when assigning the IP. For example, should you need to revert the device to the IP factory settings, please follow these steps:

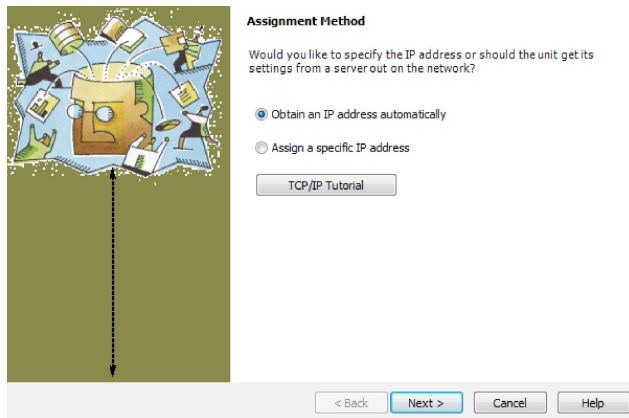

FIGURE 68: Select obtain an IP address automatically and click next.

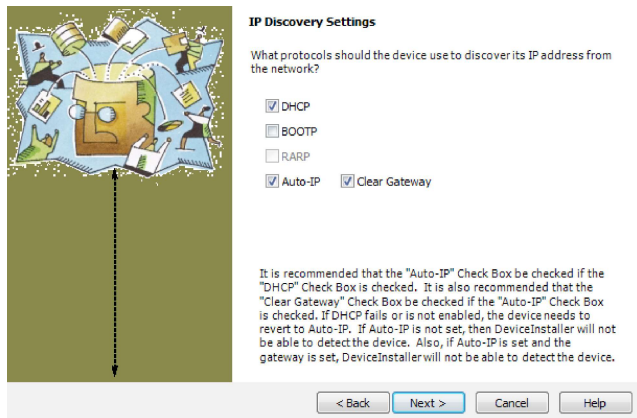

FIGURE 69: Select IP address and subnet mask compatible with your PC. Click next.

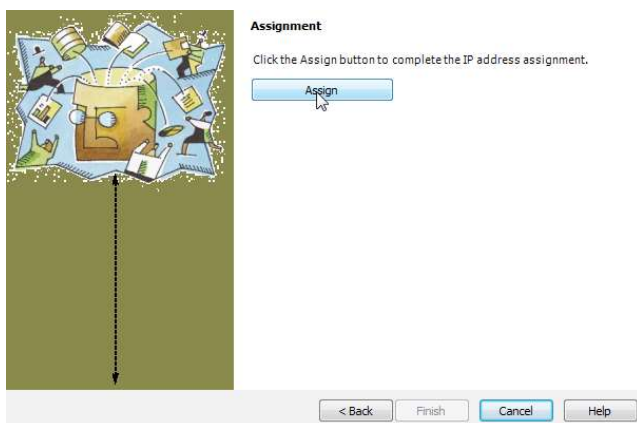

FIGURE 70: When done press the Assign button.

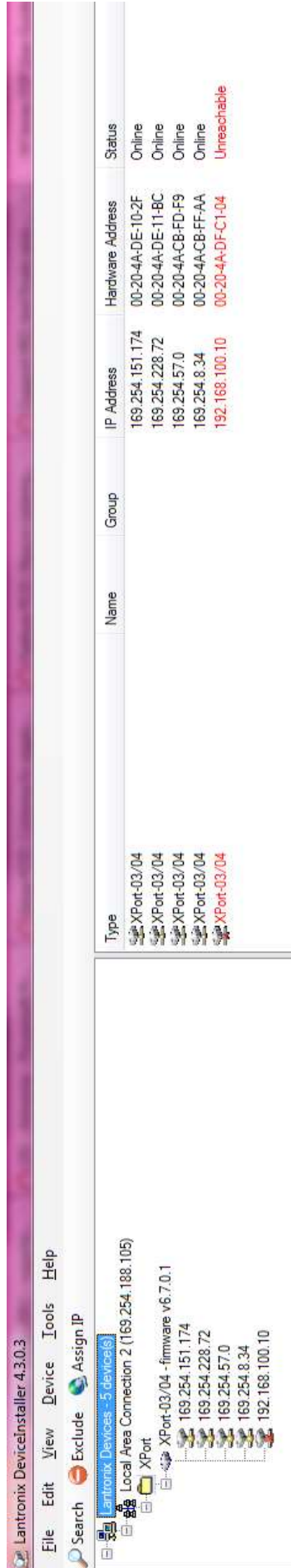

FIGURE 71: All Lantronix devices on the network. A pre existing static IP unit appears.

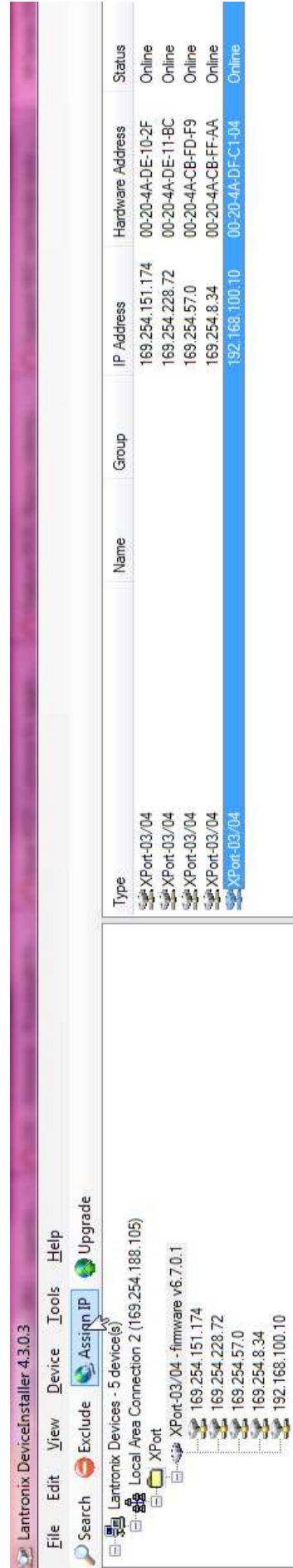

FIGURE 72: The selected device.

12.2 Appendix: Output Configurations

Lo-Z

	CH1	CH2	CH3	CH4	CH5	CH6	CH7	CH8
8x150W @ 4Ω	Lo-Z	Lo-Z	Lo-Z	Lo-Z	Lo-Z	Lo-Z	Lo-Z	Lo-Z
1x300W @ 8Ω + 6x150W @ 4Ω	Bridged		Lo-Z	Lo-Z	Lo-Z	Lo-Z	Lo-Z	Lo-Z
2x300W @ 8Ω + 4x150W @ 4Ω	Bridged		Bridged		Lo-Z	Lo-Z	Lo-Z	Lo-Z
3x300W @ 8Ω + 2x150W @ 4Ω	Bridged		Bridged		Bridged		Lo-Z	Lo-Z
4x300W @ 8Ω	Bridged		Bridged		Bridged		Bridged	

Hi-Z (70 or 100 V)

	CH1	CH2	CH3	CH4	CH5	CH6	CH7	CH8
8x125W (70V/100V)	Hi-Z*	Hi-Z*	Hi-Z*	Hi-Z*	Hi-Z*	Hi-Z*	Hi-Z*	Hi-Z*
1x250W + 6x125W	Parallel**		Hi-Z*	Hi-Z*	Hi-Z*	Hi-Z*	Hi-Z*	Hi-Z*
2x250W + 4x125W	Parallel**		Parallel**		Hi-Z*	Hi-Z*	Hi-Z*	Hi-Z*
3x250W + 2x125W	Parallel**		Parallel**		Parallel**		Hi-Z*	Hi-Z*
4x300W @ 8Ω	Parallel**		Parallel**		Parallel**		Parallel**	

* Channel with BatFormer 70V or 100V ** both channels with BatFormers

Mixed configurations

8 Channels								
	CH1	CH2	CH3	CH4	CH5	CH6	CH7	CH8
1x125W (70V/100V) + 7x150W @ 4Ω	Hi-Z*	Lo-Z	Lo-Z	Lo-Z	Lo-Z	Lo-Z	Lo-Z	Lo-Z
2x125W (70V/100V) + 6x150W @ 4Ω	Hi-Z*	Hi-Z*	Lo-Z	Lo-Z	Lo-Z	Lo-Z	Lo-Z	Lo-Z
3x125W (70V/100V) + 5x150W @ 4Ω	Hi-Z*	Hi-Z*	Hi-Z*	Lo-Z	Lo-Z	Lo-Z	Lo-Z	Lo-Z
4x125W (70V/100V) + 4x150W @ 4Ω	Hi-Z*	Hi-Z*	Hi-Z*	Hi-Z*	Lo-Z	Lo-Z	Lo-Z	Lo-Z
5x125W (70V/100V) + 3x150W @ 4Ω	Hi-Z*	Hi-Z*	Hi-Z*	Hi-Z*	Hi-Z*	Lo-Z	Lo-Z	Lo-Z
6x125W (70V/100V) + 2x150W @ 4Ω	Hi-Z*	Hi-Z*	Hi-Z*	Hi-Z*	Hi-Z*	Hi-Z*	Lo-Z	Lo-Z
7x125W (70V/100V) + 1x150W @ 4Ω	Hi-Z*	Hi-Z*	Hi-Z*	Hi-Z*	Hi-Z*	Hi-Z*	Hi-Z*	Lo-Z

* Channel with BatFormer 70V or 100V

Mixed configurations

7 Channels								
	CH1	CH2	CH3	CH4	CH5	CH6	CH7	CH8
1 x 250W (70/100V) + 6x150W @ 4Ω	Parallel**		Lo-Z	Lo-Z	Lo-Z	Lo-Z	Lo-Z	Lo-Z
1x250W (70/100V) + 1x125W (70/100V) + 5x150W @ 4Ω	Parallel**		Hi-Z*	Lo-Z	Lo-Z	Lo-Z	Lo-Z	Lo-Z
1x250W (70/100V) + 2x125W (70/100V) + 4x150W @ 4Ω	Parallel**		Hi-Z*	Hi-Z*	Lo-Z	Lo-Z	Lo-Z	Lo-Z
1x250W (70/100V) + 3x125W (70/100V) + 3x150W @ 4Ω	Parallel**		Hi-Z*	Hi-Z*	Hi-Z*	Lo-Z	Lo-Z	Lo-Z
1x250W (70/100V) + 4x125W (70/100V) + 2x150W @ 4Ω	Parallel**		Hi-Z*	Hi-Z*	Hi-Z*	Hi-Z*	Lo-Z	Lo-Z
1x250W (70/100V) + 5x125W (70/100V) + 1x150W @ 4Ω	Parallel**		Hi-Z*	Hi-Z*	Hi-Z*	Hi-Z*	Hi-Z*	Lo-Z
1 x 300W @ 8Ω + 6 x 125W (70/100V)	Bridged		Hi-Z*	Hi-Z*	Hi-Z*	Hi-Z*	Hi-Z*	Hi-Z*
1 x 300W @ 8Ω + 1 x 150W @ 4Ω + 5 x 125W (70/100V)	Bridged		Lo-Z	Hi-Z*	Hi-Z*	Hi-Z*	Hi-Z*	Hi-Z*
1 x 300W @ 8Ω + 2 x 150W @ 4Ω + 4 x 125W (70/100V)	Bridged		Lo-Z	Lo-Z	Hi-Z*	Hi-Z*	Hi-Z*	Hi-Z*
1 x 300W @ 8Ω + 3 x 150W @ 4Ω + 3 x 125W (70/100V)	Bridged		Lo-Z	Lo-Z	Lo-Z	Hi-Z*	Hi-Z*	Hi-Z*
1 x 300W @ 8Ω + 4 x 150W @ 4Ω + 2 x 125W (70/100V)	Bridged		Lo-Z	Lo-Z	Lo-Z	Lo-Z	Hi-Z*	Hi-Z*
1 x 300W @ 8Ω + 5 x 150W @ 4Ω + 1 x 125W (70/100V)	Bridged		Lo-Z	Lo-Z	Lo-Z	Lo-Z	Lo-Z	Hi-Z*

* Channel with BatFormer 70V or 100V ** both channels with BatFormers

Mixed configurations

6 Channels								
	CH1	CH2	CH3	CH4	CH5	CH6	CH7	CH8
2x250W (70/100V) + 4x150W @ 4Ω	Parallel**		Parallel**		Lo-Z	Lo-Z	Lo-Z	Lo-Z
2x250W (70/100V) + 1x125W (70/100V) + 3x150W @ 4Ω	Parallel**		Parallel**		Hi-Z*	Lo-Z	Lo-Z	Lo-Z
2x250W (70/100V) + 2x125W (70/100V) + 2x150W @ 4Ω	Parallel**		Parallel**		Hi-Z*	Hi-Z*	Lo-Z	Lo-Z
2x250W (70/100V) + 3x125W (70/100V) + 1x150W @ 4Ω	Parallel**		Parallel**		Hi-Z*	Hi-Z*	Hi-Z*	Lo-Z
2x300W @ 8Ω + 4x125W (70/100V)	Bridged		Bridged		Hi-Z*	Hi-Z*	Hi-Z*	Hi-Z*
2x300W @ 8Ω + 1x150W @ 4Ω + 3x125W (70/100V)	Bridged		Bridged		Lo-Z	Hi-Z*	Hi-Z*	Hi-Z*
2x300W @ 8Ω + 2x150W @ 4Ω + 2x125W (70/100V)	Bridged		Bridged		Lo-Z	Lo-Z	Hi-Z*	Hi-Z*
2x300W @ 8Ω + 3x150W @ 4Ω + 1x125W (70/100V)	Bridged		Bridged		Lo-Z	Lo-Z	Lo-Z	Hi-Z*
1x250W (70/100V) + 1x300W @ 8Ω + 4x150W @ 4Ω	Parallel**		Bridged		Lo-Z	Lo-Z	Lo-Z	Lo-Z
1x250W (70/100V) + 1x300W @ 8Ω + 1x125W (70/100V) + 3x150W @ 4Ω	Parallel**		Bridged		Hi-Z*	Lo-Z	Lo-Z	Lo-Z
1x250W (70/100V) + 1x300W @ 8Ω + 2x125W (70/100V) + 2x150W @ 4Ω	Parallel**		Bridged		Hi-Z*	Hi-Z*	Lo-Z	Lo-Z
1x250W (70/100V) + 1x300W @ 8Ω + 3x125W (70/100V) + 1x150W @ 4Ω	Parallel**		Bridged		Hi-Z*	Hi-Z*	Hi-Z*	Lo-Z
1x250W (70/100V) + 1x300W @ 8Ω + 4x125W (70/100V)	Parallel**		Bridged		Hi-Z*	Hi-Z*	Hi-Z*	Hi-Z*

* Channel with BatFormer 70V or 100V ** both channels with BatFormers

Mixed configurations

5 Channels								
	CH1	CH2	CH3	CH4	CH5	CH6	CH7	CH8
3x250W (70/100V) + 2x150W @ 4Ω	Parallel**		Parallel**		Parallel**		Lo-Z	Lo-Z
3x250W (70/100V) + 1x125W (70/100V) + 1x150W @ 4Ω	Parallel**		Parallel**		Parallel**		Hi-Z*	Lo-Z
3x300W @ 8Ω + 2x125W (70/100V)	Bridged		Bridged		Bridged		Hi-Z*	Lo-Z
3x300W @ 8Ω + 1x150W @ 4Ω + 1x125W(70/100V)	Bridged		Bridged		Bridged		Lo-Z	Lo-Z
2x250W (70/100V) + 1x300W @ 8Ω + 2x150W @ 4Ω	Parallel**		Parallel**		Bridged		Lo-Z	Lo-Z
2x250W (70/100V) + 1x300W @ 8Ω + 1x125W(70/100V) + 1x150W @ 4Ω	Parallel**		Parallel**		Bridged		Hi-Z*	Lo-Z
2x250W (70/100V) + 1x300W @ 8Ω + 2x125W (70/100V)	Bridged		Parallel**		Bridged		Hi-Z*	Hi-Z*
1x250W (70/100V) + 2x300W @ 8Ω + 2x150W @ 4Ω	Bridged		Bridged		Bridged		Lo-Z	Hi-Z*
1x250W (70/100V) + 2x300W @ 8Ω + 1x125W (70/100V) + 1x150W @ 4Ω	Bridged		Bridged		Bridged		Hi-Z*	Hi-Z*
1x250W (70/100V) + 2x300W @ 8Ω + 2x125W (70/100V)	Bridged		Bridged		Bridged		Hi-Z*	Hi-Z*

* Channel with BatFormer 70V or 100V ** both channels with BatFormers

4 Channels								
	CH1	CH2	CH3	CH4	CH5	CH6	CH7	CH8
1 x 250W (70/100V) + 3 x 300W @ 8Ω	Parallel**		Bridged		Bridged		Bridged	
2 x 250W (70/100V) + 2 x 300W @ 8Ω	Parallel**		Parallel**		Bridged		Bridged	
3 x 250W (70/100V) + 1 x 300W @ 8Ω	Parallel**		Parallel**		Parallel**		Bridged	

* Channel with BatFormer 70V or 100V ** both channels with BatFormers

13 Troubleshooting

Problem	Check that...
No power	<ul style="list-style-type: none"> ▶ AC mains voltage is within the correct range 110V-240V \pm10% ▶ AC mains cord is correctly inserted and connected to mains outlet ▶ Rear panel switch (which is not accessible from the front of the amplifier) is on the ON position ▶ Mains fuse (accessible from the rear panel) is not blown
No sound	<ul style="list-style-type: none"> ▶ Audio inputs/outputs are correctly connected: the input channel number corresponds to the correct output channel number connected to the speakers ▶ The signal presence LED on the front panel is on. If this is so, check that the front panel attenuators (which are under the left hand side removable silver colored panel bearing the Powersoft logo) are correctly set ▶ If line inputs are selected, then line inputs (and not auxiliary inputs) are connected. If auxiliary inputs are selected all bottom green LEDs on the central portion of the front panel will blink ▶ Loudspeakers are working as expected ▶ Signal cables are not interrupted or short circuited ▶ Input and output cables are correctly inserted in their respective Phoenix connectors ▶ Input and output signal connectors are correctly inserted in the amp's Phoenix connectors
No sound after BatFormer installation or removal	<ul style="list-style-type: none"> ▶ BatFormers are correctly and fully inserted when lo-Z jumper boards are removed ▶ Lo-Z jumper boards are correctly re-installed when BatFormers are removed
Low audio power on channels equipped with BatFormers	<ul style="list-style-type: none"> ▶ Correct BatFormer type (70V or 100V) has been installed
Low power and bad audio quality on channels equipped with BatFormers	<ul style="list-style-type: none"> ▶ Channel is connected to a hi-Z loudspeaker
Low power and bad audio quality	<ul style="list-style-type: none"> ▶ The amp's output is connected to lo-Z loudspeakers
Front panel yellow LEDs steadily on-thermal warning	<ul style="list-style-type: none"> ▶ All connections and environmental conditions allow for correct amplifier performance
Front panel "ready" green LED (second from the bottom) is off, both yellow and red LEDs are steadily on	<ul style="list-style-type: none"> ▶ Environmental conditions allow adequate cooling. The amplifier is in thermal halt and must be turned off
During functioning any front panel "ready" green LEDs turns off	<ul style="list-style-type: none"> ▶ You have the unit's user manual and/or a phone or internet connection handy: the unit must be switched off and you need to contact an Authorized Powersoft Service Center

