

V 45

FULL RANGE PASSIVE TWO-WAY SPEAKER

DESCRIPTION

The V45 is two-way full range loudspeaker system that incorporate 2 x 15" LF transducers and a 4" voice coil, titanium, compression driver. The system is very compact and provides very high output and accurate voice and sound reproduction. The system is equipped with the latest generation of RCF precision transducers. The LF drivers are equipped with a 4" voice coil and a state of the art ferrite motor, are mounted in a vented enclosure with optimised front loading. The 4.0" HF titanium compression driver is a state of the art in compression drivers designs and is loaded on a constant directivity horn with a perfect coverage of 90° x 40°.



FEATURES

- High power, two-way bass reflex full range system
- 2 x 15" high power, 4" voice coil hypervented woofers
- 1 x 4" high power titanium neo compression driver
- 137 dB max SPL
- 1800 Watt AES
- Very high output, response down to 40 Hz
- Birch plywood cabinet
- Weather resistant, textured, polyurea finish
- Epoxy powder coated front grille

TECHNICAL SPECIFICATIONS

Acoustical specifications	Frequency Response (-10dB):	30 Hz ÷ 20000 Hz
	Max SPL @ 1m:	137 dB
	Horizontal coverage angle:	90°
	Vertical coverage angle:	40°
	Directivity index Q:	10
	System Sensitivity:	99 dB
Power section	Nominal Impedance (ohm):	4 ohm
	Power Handling:	1800 W RMS
	Peak Power Handling:	7200 W PEAK
	Recommended Amplifier:	3600 W
	Crossover Frequencies:	1200 Hz
Transducers	Compression Driver:	1.4" neo, 4.0" v.c
	Nominal Impedance (ohm):	8 ohm
	Input Power Rating:	140 W AES, 280 W PEAK
	Sensitivity:	110 dB, 1W @ 1m
	Woofers:	2 x 15", 4.0" v.c
	Nominal Impedance (ohm):	8 ohm
	Input Power Rating:	900 W AES, 1800 W PEAK
Sensitivity:	97 dB, 1W @ 1m	
Input/Output section	Input connectors:	Speakon® NL4
	Output connectors:	Speakon® NL4
Standard compliance	CE marking:	Yes
Physical specifications	Cabinet/Case Material:	Baltic birch plywood
	Hardware:	12 x M10 inserts
	Handles:	1 side
	Grille:	Steel
	Color:	Black
Size	Height:	1109 mm / 43.66 inches
	Width:	554 mm / 21.81 inches
	Depth:	579 mm / 22.8 inches
	Weight:	63 kg / 138.89 lbs
Shipping informations	Package Height:	1170 mm / 46.06 inches
	Package Width:	640 mm / 25.2 inches
	Package Depth:	610 mm / 24.02 inches
	Package Weight:	63 kg / 138.89 lbs



PART NUMBER

- **13000413**

V 45

EAN 8024530010973

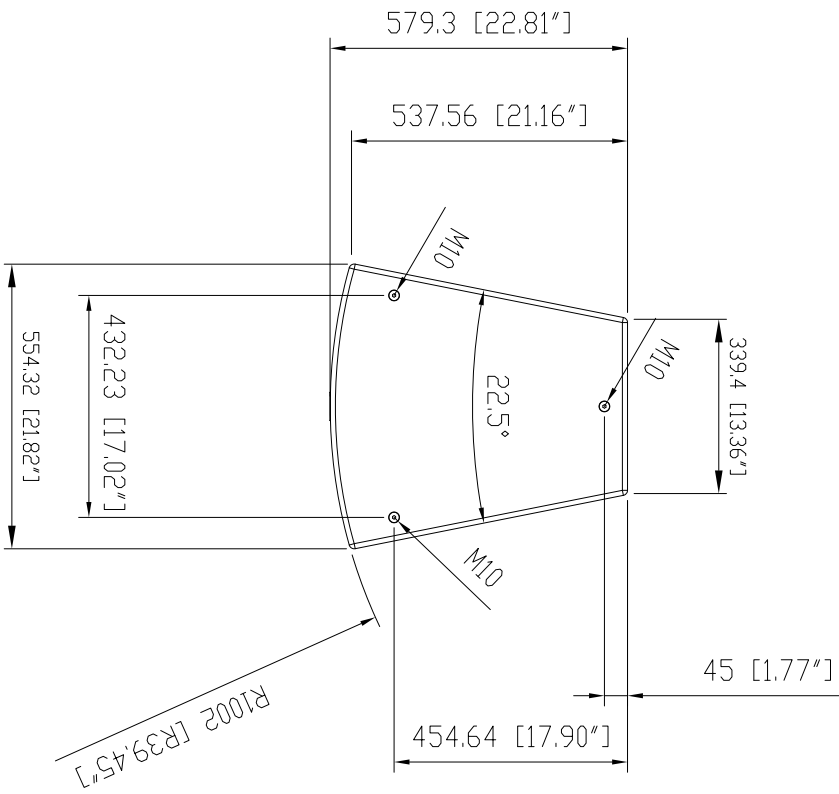
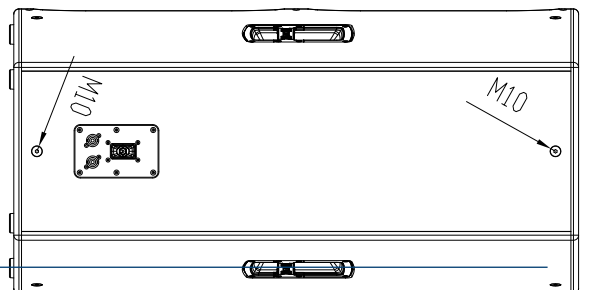
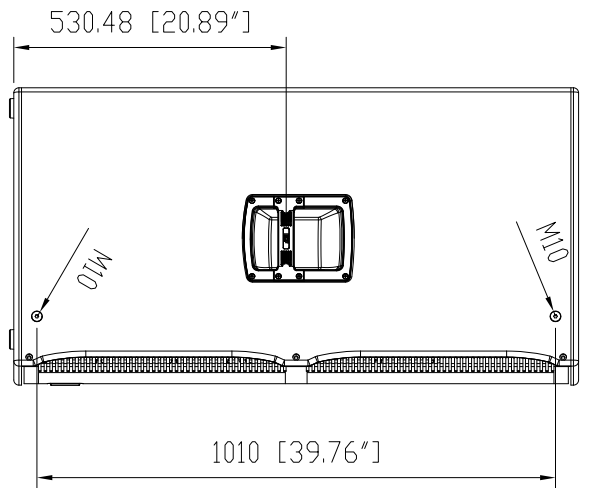
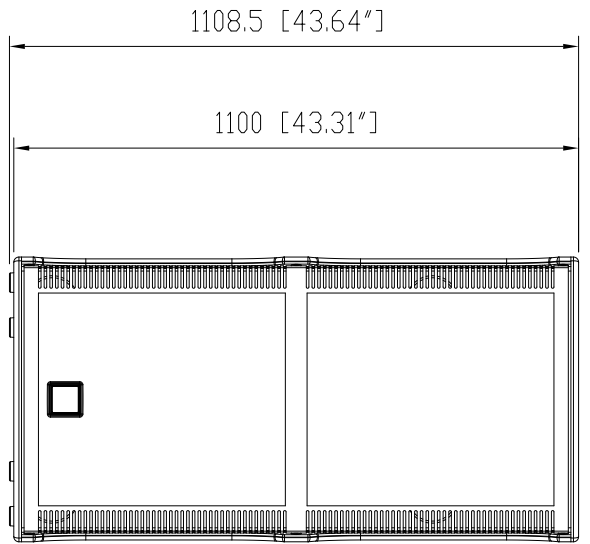
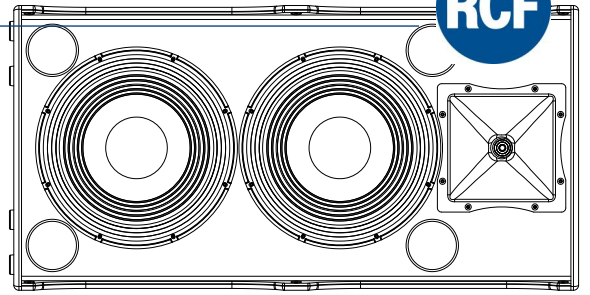

V 45

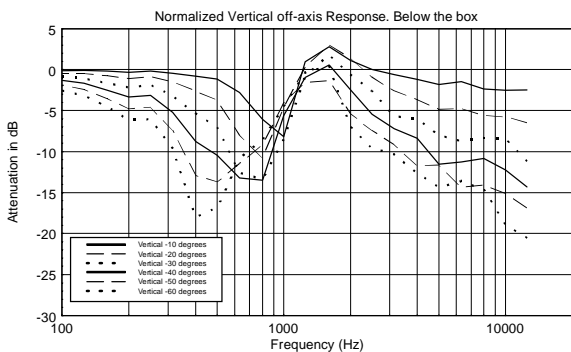
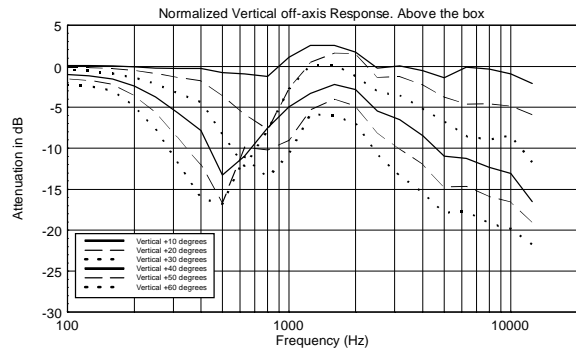
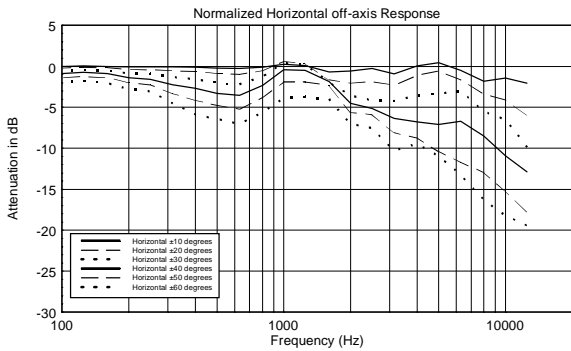
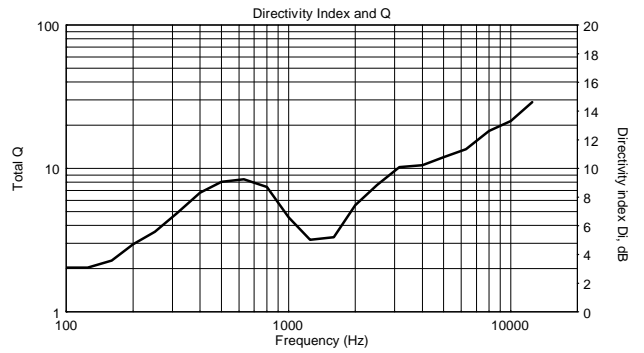
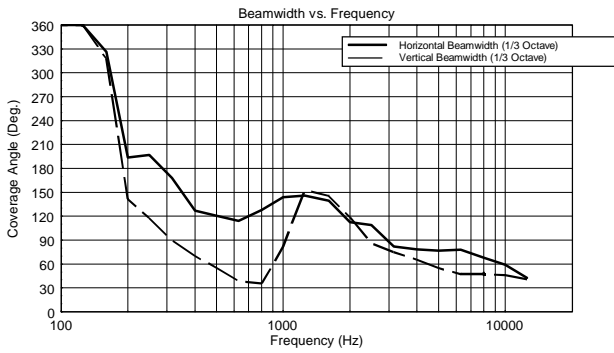
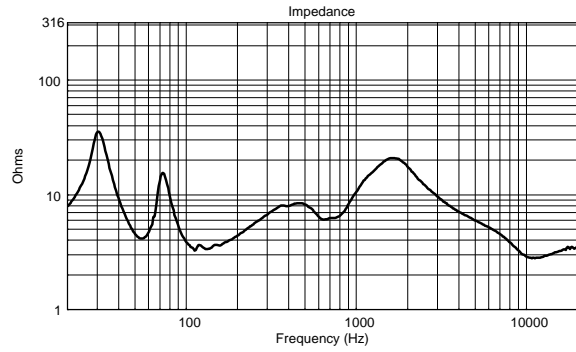
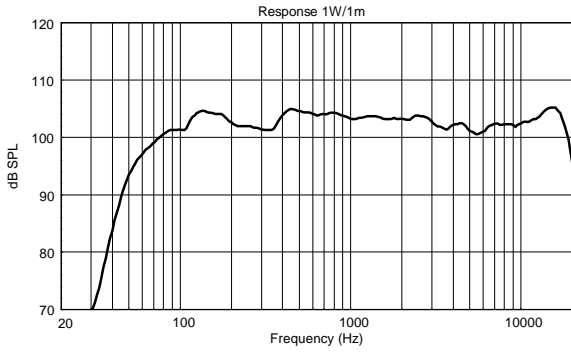

Horizontal 1/3 Octave Polars

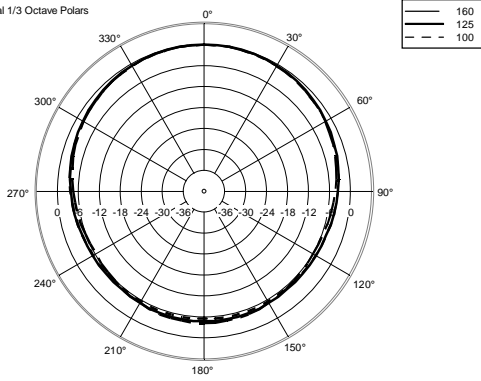

Horizontal 1/3 Octave Polars

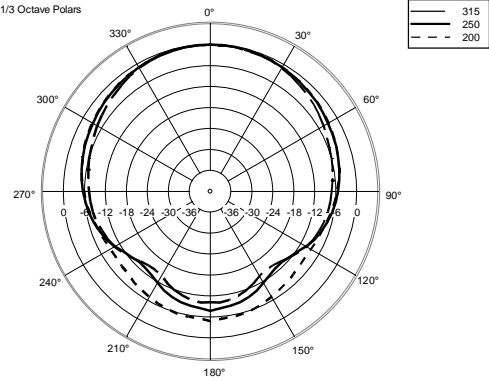

Horizontal 1/3 Octave Polars

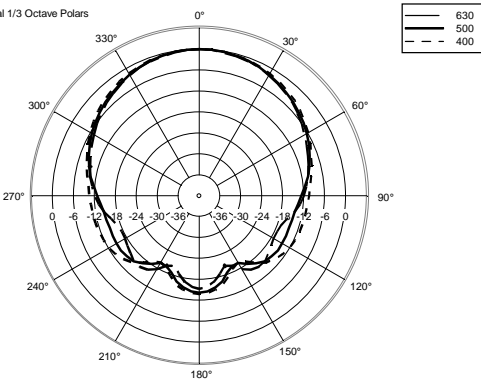

Horizontal 1/3 Octave Polars

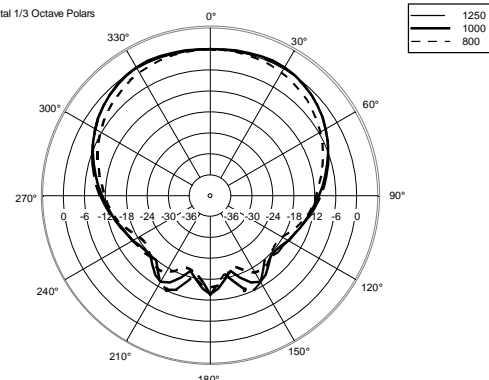

Horizontal 1/3 Octave Polars

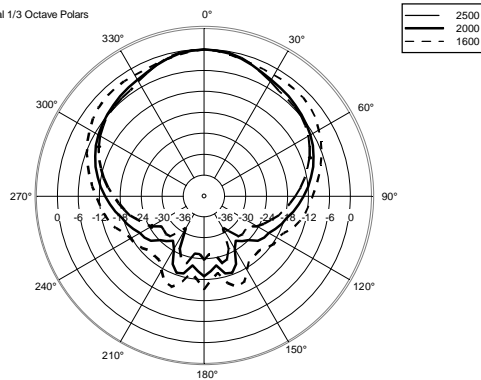

Horizontal 1/3 Octave Polars

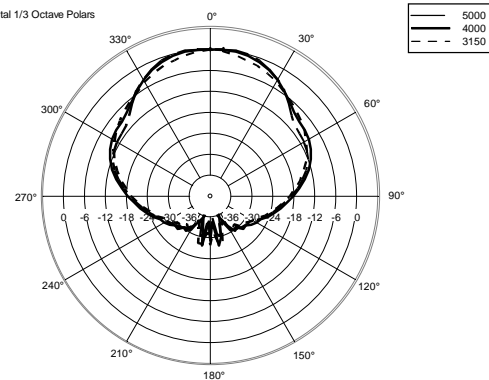

Horizontal 1/3 Octave Polars

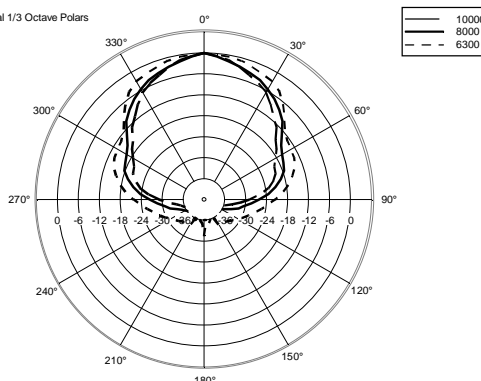

Horizontal One Octave Polars

