

NXL 44-A

ACTIVE TWO-WAY ARRAY

DESCRIPTION

NXL 44-A is a line array column speaker featuring a two-channel 1,400 Watt amplifier powering three 10" neodymium woofers and a 1.4" driver with 3" voice coil on an asymmetrical waveguide. The horn's design delivers accurate sound to the coverage area without tilting the enclosure. The speaker delivers an extended frequency range down to 45 Hz, used alone or coupled with subwoofers for medium-sized concerts and DJ sets. Precision controlled by an on-board DSP, the NXL 44-A is ideal for professional live sound reinforcement with sleek design, incredible power, and sound detail. A complete set of rigging accessories allows for simple flying and stacking.



FEATURES

- Digital bi-amped amplifier with 1400 Watt peak power
- 90° x 30° constant directivity waveguide, tilted (+5°, -25°)
- 3 x 10" neodymium woofer
- 1.4" compression neodymium driver, 3.0" voice coil
- DSP Processing with optimized phase response
- Easy-to-fly and install with built-in rigging points

TECHNICAL SPECIFICATIONS

Acoustical specifications	Frequency Response:	45 Hz ÷ 20000 Hz
	Max SPL @ 1m:	134 dB
	Horizontal coverage angle:	90°
	Vertical coverage angle:	30°
Transducers	Compression Driver:	1 x 1.4" neo, 3.0" v.c
	Woofers:	3 x 10" neo, 2.5" v.c
Input/Output section	Input signal:	bal/unbal
	Input connectors:	XLR, Jack
	Output connectors:	XLR
	Input sensitivity:	-2 dBu/+4 dBu
Processor section	Crossover Frequencies:	800 Hz
	Protections:	Thermal, RMS
	Limiter:	Soft Limiter
	Controls:	Volume, EQ Shape, Mic/Line
Power section	Total Power:	1400 W Peak, 700 W RMS
	High frequencies:	400 W Peak, 200 W RMS
	Low frequencies:	1000 W Peak, 500 W RMS
	Cooling:	Convection
	Connections:	Powercon IN/OUT
Standard compliance	CE marking:	Yes
Physical specifications	Cabinet/Case Material:	Baltic birch plywood
	Hardware:	4 x M8, 4 x quick lock, 2 x pole mount
	Handles:	4 side
	Pole mount/Cap:	Yes
	Grille:	Steel
	Color:	Black
Size	Height:	1198 mm / 47.17 inches
	Width:	303 mm / 11.93 inches
	Depth:	402 mm / 15.83 inches
	Weight:	34.5 kg / 76.06 lbs
Shipping informations	Package Height:	437 mm / 17.2 inches
	Package Width:	1224 mm / 48.19 inches
	Package Depth:	330 mm / 12.99 inches
	Package Weight:	36.5 kg / 80.47 lbs



PART NUMBER

• **13000480**

NXL 44-A

115V

EAN 8024530013660

• **13000479**

NXL 44-A

220-240V

EAN 8024530013523

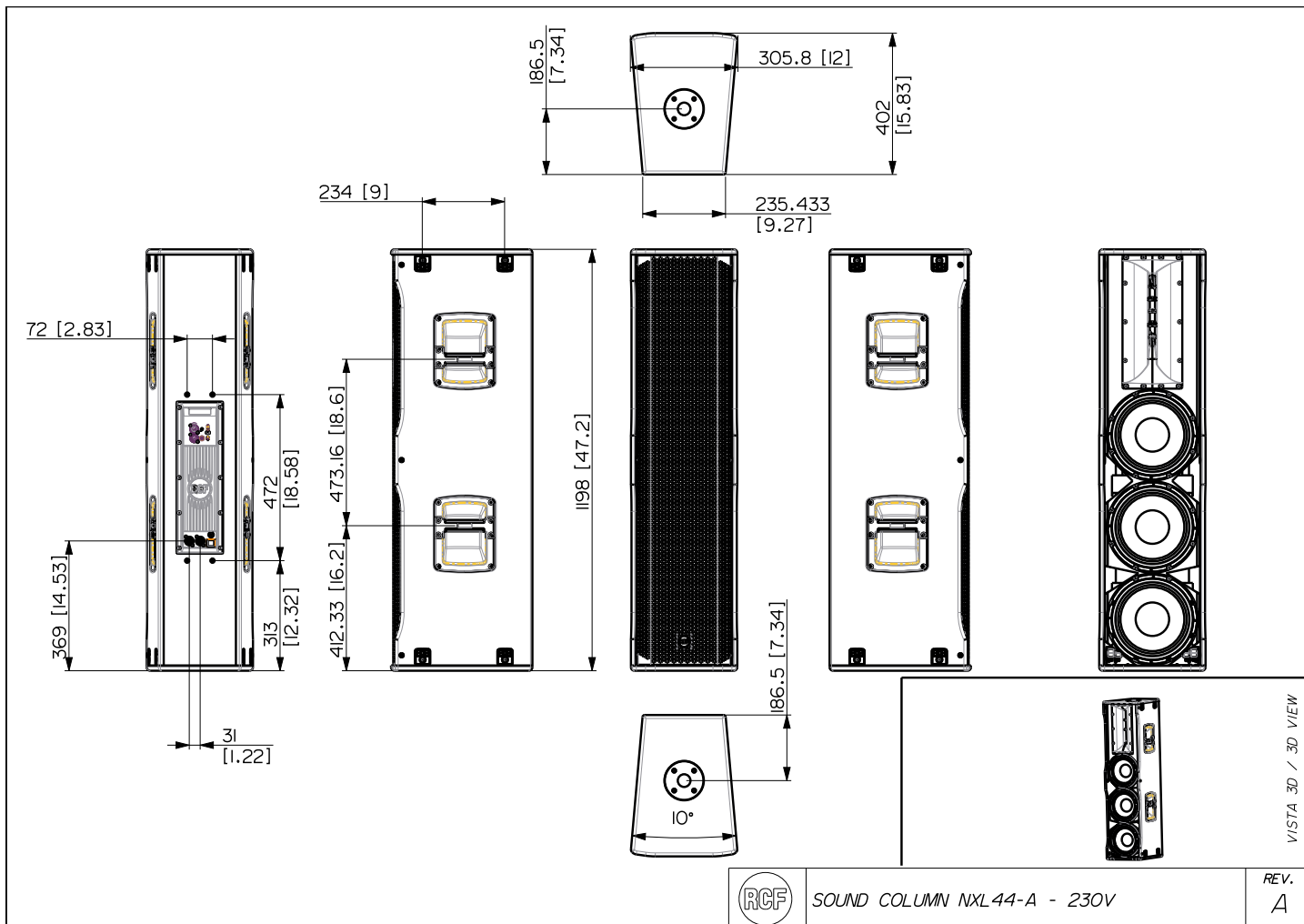

SOUND COLUMN NXL44-A - 230V

REV.
A



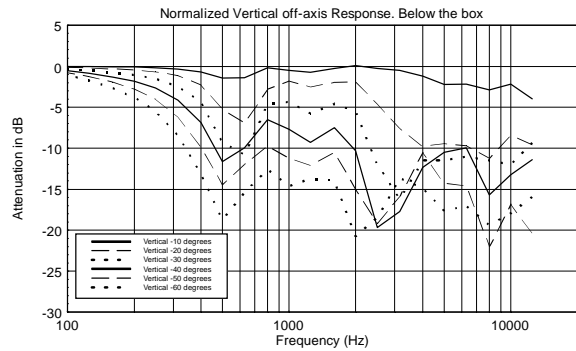
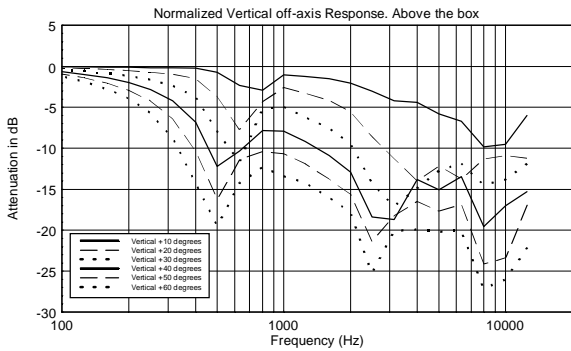
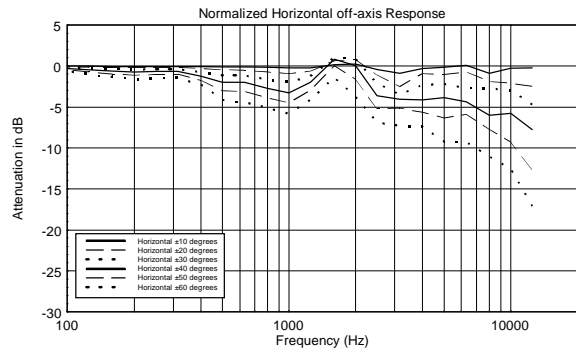
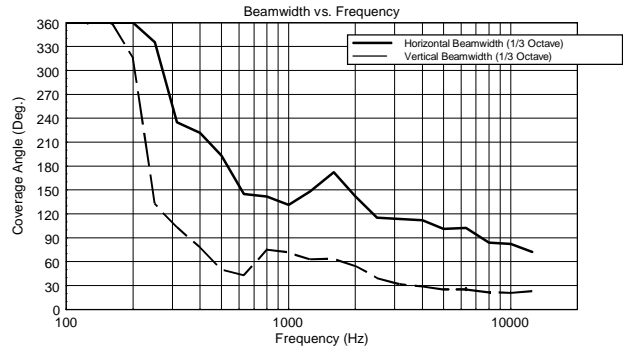
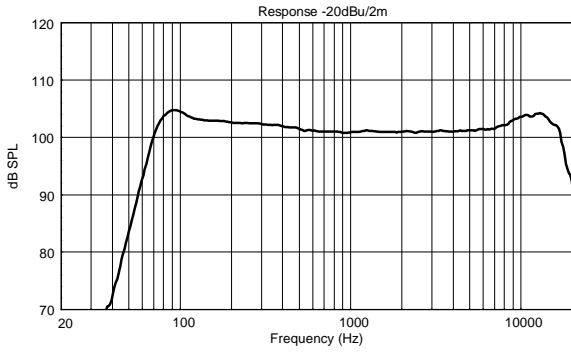

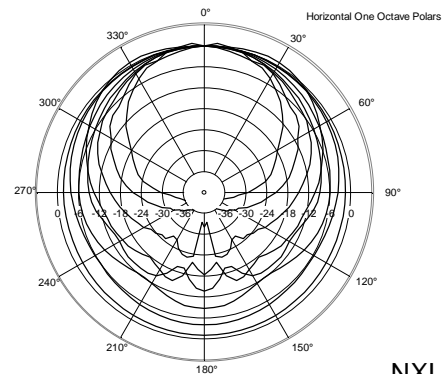
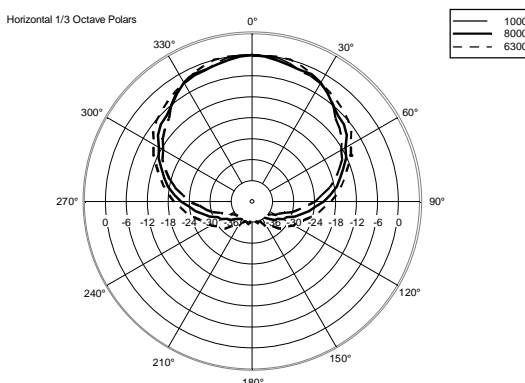
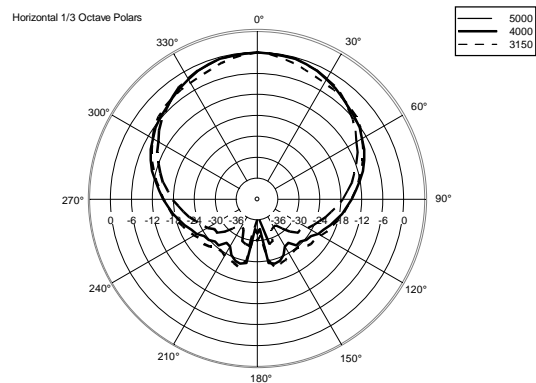
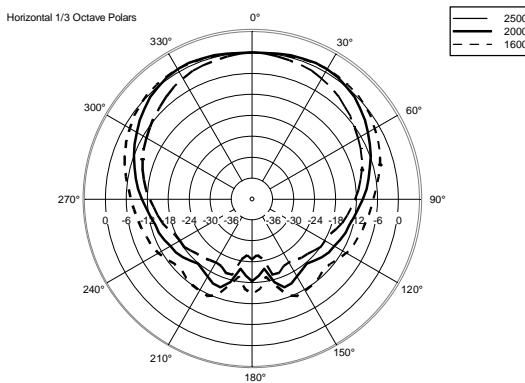
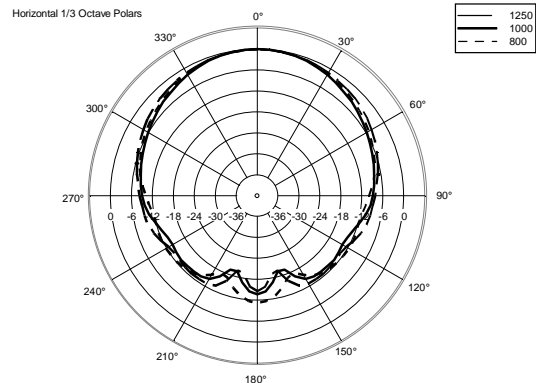
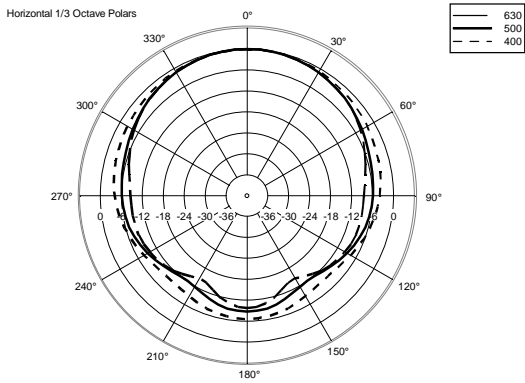
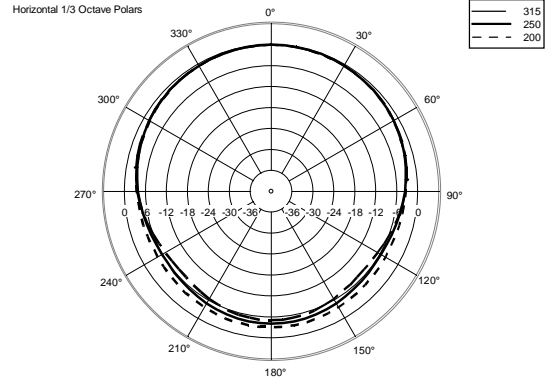
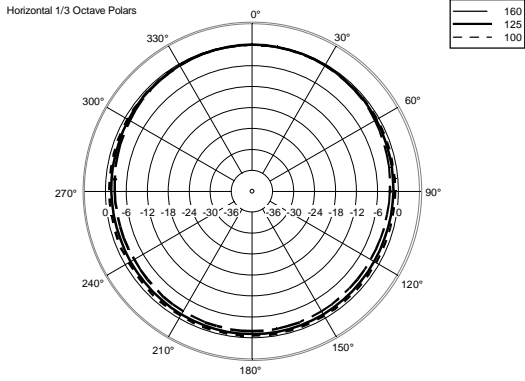

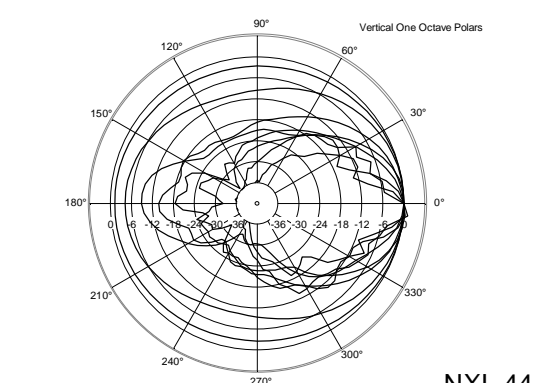
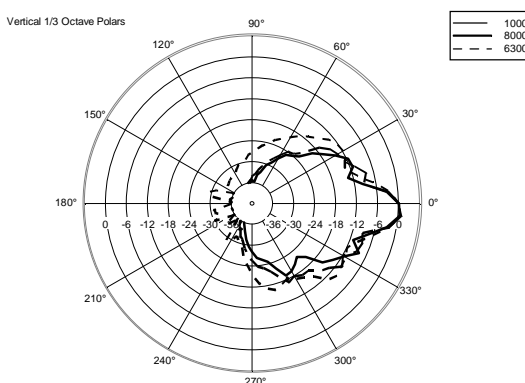
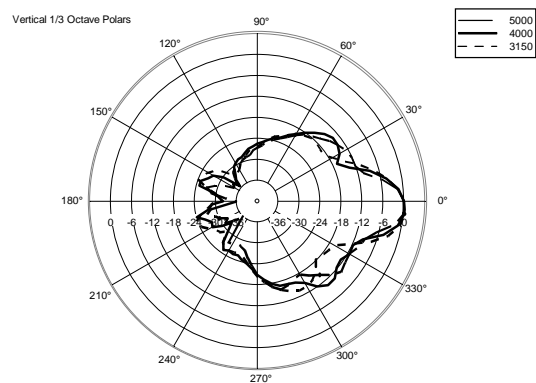
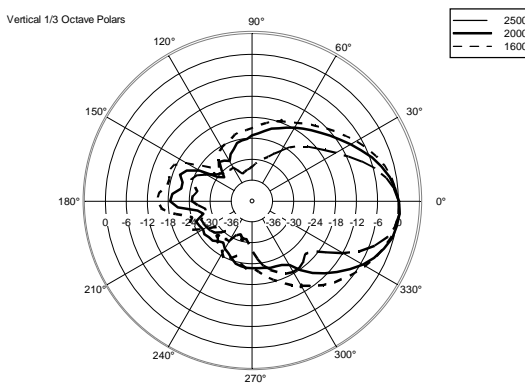
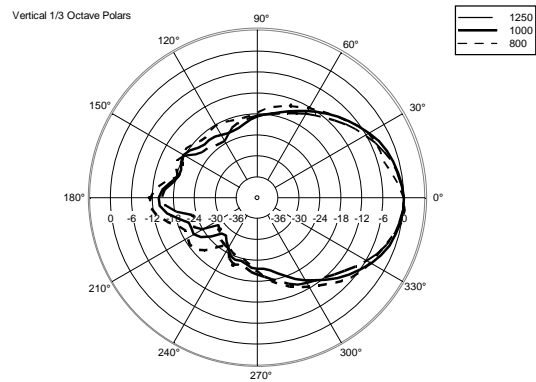
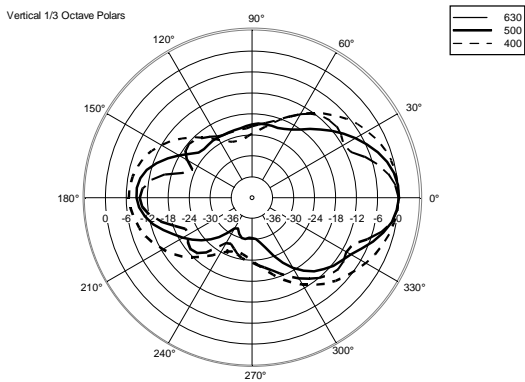
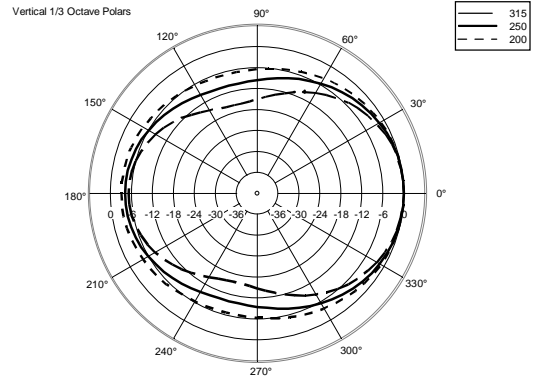
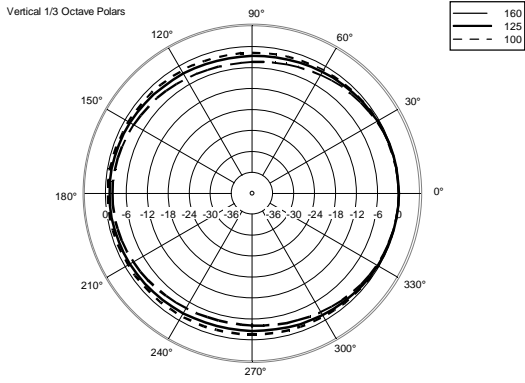

VISTA 3D / 3D VIEW







ACCESSORIES

	AC PMA - POLE MOUNT	PART NUMBER EAN:	13360034 8024530007713
	AC PM-M20	PART NUMBER EAN:	13360067 8024530014599
	AC PMX POLE MOUNT M20	PART NUMBER EAN:	13360232 8024530010058
	AC PRO-FS PROFESS. LOCKING FLOOR STAND	PART NUMBER EAN:	13360109 8024530006471
	AC PRO-PM PROFESS. LOCKING POLE MOUNT	PART NUMBER EAN:	13360110 8024530006488
	FLY BAR FL-B NXL 44	PART NUMBER EAN:	13360345 8024530013653
	LINK BAR FL-B LINK NXL 44	PART NUMBER EAN:	13360346 8024530013639
	STACKING KIT 2X NXL44-A	PART NUMBER EAN:	13360347 8024530013646