

# MQ 80P

## TWO-WAY INDOOR OUTDOOR SPEAKER

### DESCRIPTION

High intelligibility, high efficiency and compact design make the RCF MQ80P 2-way horn-loaded sound projector speaker system the ideal solution to get clear voice and music reproduction in mid-size environment.

Suitable for PA systems and background/foreground music systems. Thanks to its 90° X 60° constant directivity and to simple accessories it can be combined in clusters of 2 or more pieces to get wide and smooth coverage and to reduce the installation points. It is suitable for both indoor and outdoor installations (IP 55). The woofer is a high-excursion, PP coated paper cone – rubber surround design mounted in a tuned enclosure (port can be sealed for full outdoor installation).

The tweeter is a horn-loaded compression driver with phase plug, the only way to get real and crispy intelligible voice reproduction even in wide and noisy environments.

Installation of the MQ80P is quick thanks to the unique bracket with several fixing points and aiming facilities. Connections are made by a multi-pole cable. Wattage taps and voltage adjustments together with 8-ohm operation are selectable by means of a Rotary switch,



### FEATURES

- 5" woofer with 1" compression driver
- Power selectable (100 V): 30 W – 10 W – 10 W – 5 W
- 94 dB sensitivity
- Colour white RAL 9016 and black RAL 7021
- Plastic body, steel grille
- Protection grade IP 55

## TECHNICAL SPECIFICATIONS

<b>Acoustical specifications</b>	Frequency Response (-10dB):	100 Hz ÷ 20000 Hz
	Max SPL @ 1m:	114 dB
	Horizontal coverage angle:	90°
	Vertical coverage angle:	60°
	System Sensitivity:	94 dB
<b>Power section</b>	Nominal Impedance (ohm):	8 ohm
	Power Handling:	60 W RMS
	Peak Power Handling:	240 W PEAK
	Recommended Amplifier:	120 W
	Crossover Frequencies:	3000 Hz
<b>Transducers</b>	Compression Driver:	1 x 1.0"
	Woofers:	5.0"
<b>Input/Output section</b>	Input connectors:	Cable
	Output connectors:	Cable
	Constant Voltage Transformer:	100 V
	Power selection 1 (100 V):	30 W - 333 ohm
	Power selection 2 (100 V):	20 W - 500 ohm
	Power selection 3 (100 V):	10 W - 1000 ohm
	Power selection 4 (100 V):	5 W - 2000 ohm
<b>Standard compliance</b>	IP protection grade:	IP 55
	CE marking:	Yes
<b>Physical specifications</b>	Cabinet/Case Material:	Plastic
	Hardware:	Wall mount bracket
	Grille:	Steel
	Color:	White - RAL 9016
<b>Size</b>	Height:	223 mm / 8.78 inches
	Width:	191 mm / 7.52 inches
	Depth:	236 mm / 9.29 inches
	Weight:	3.65 kg / 8.05 lbs
<b>Shipping informations</b>	Package Height:	285 mm / 11.22 inches
	Package Width:	305 mm / 12.01 inches
	Package Depth:	250 mm / 9.84 inches
	Package Weight:	4.36 kg / 9.61 lbs



**PART NUMBER**

• **13000096**

MQ 80P W

White - RAL 9016

EAN 8024530005795

• **13000094**

MQ 80P B

Black - RAL 7021

EAN 8024530005771

**DRAWINGS**

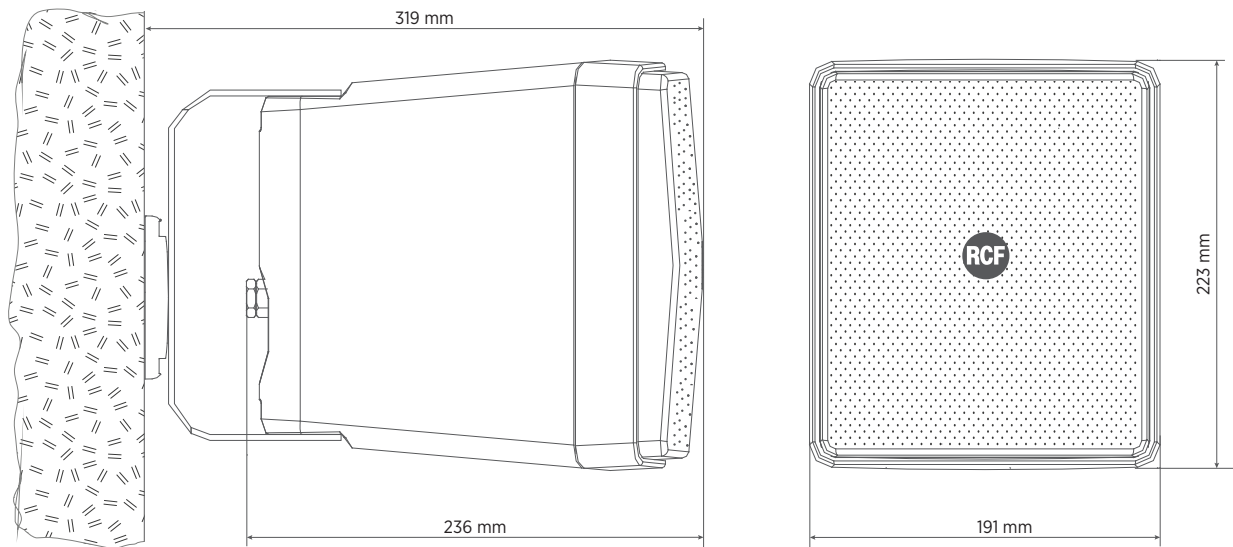

**INSTALLATION**

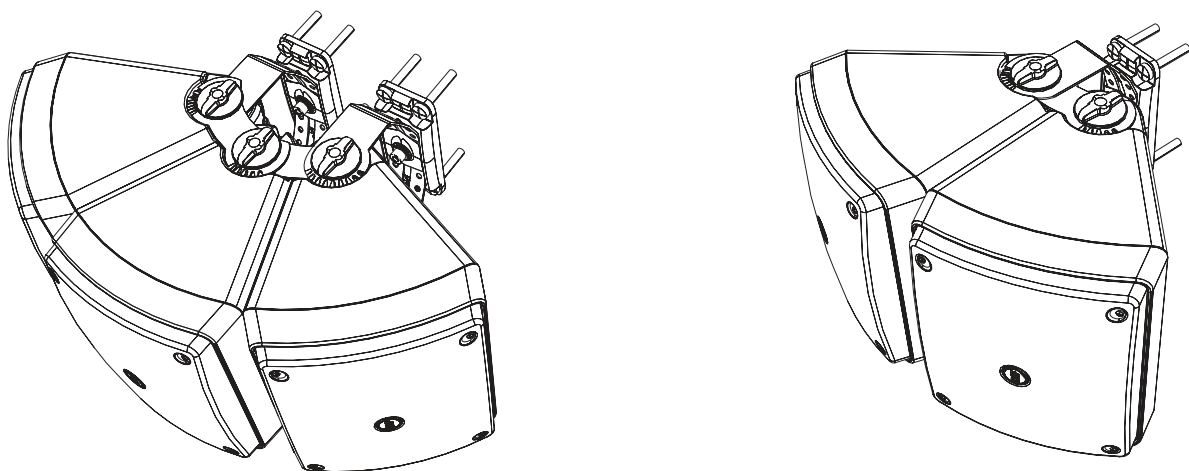

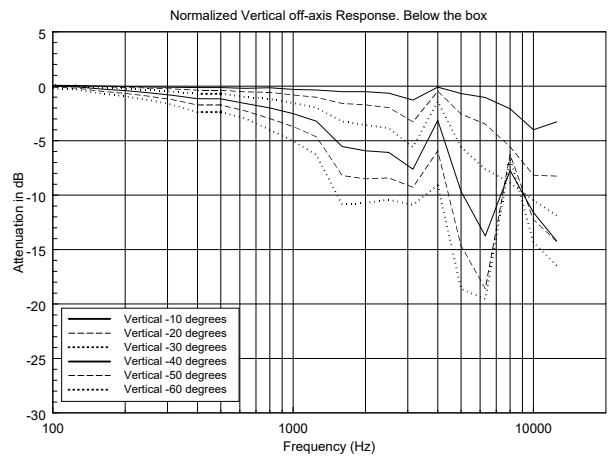
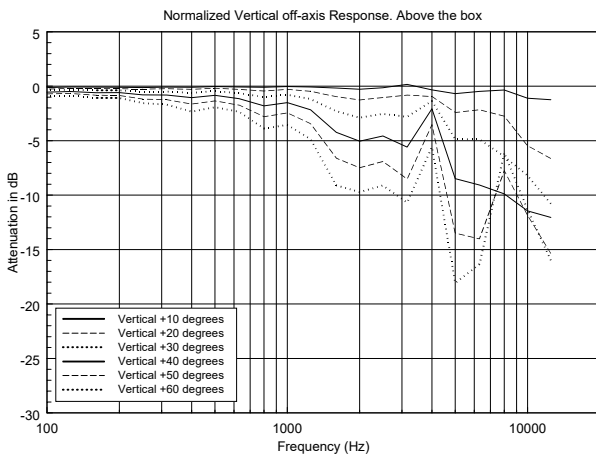
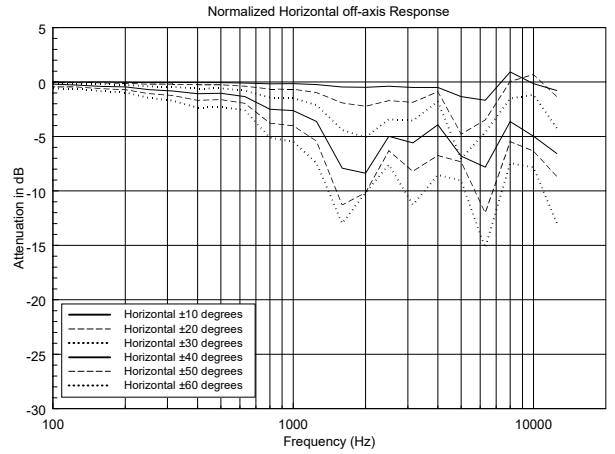
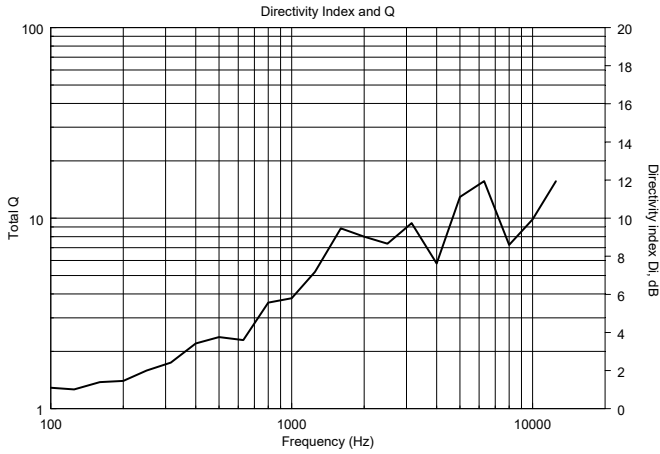
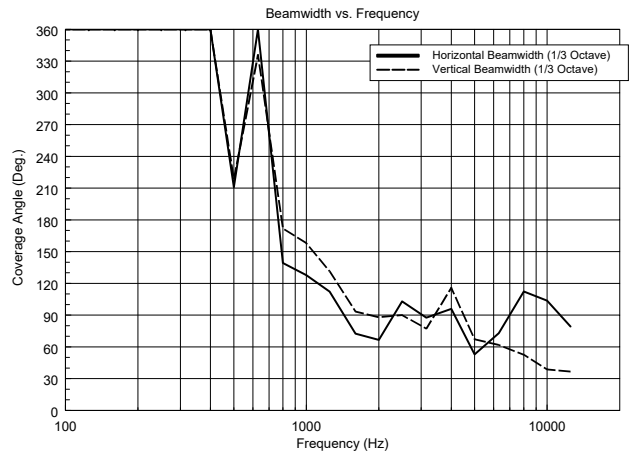
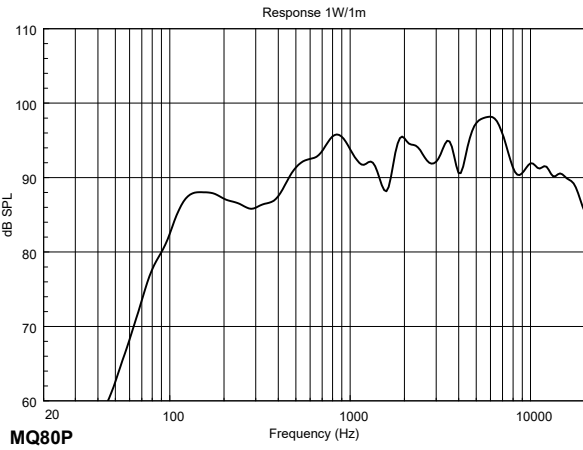

HORIZONTAL 1/3 POLAR PLOT

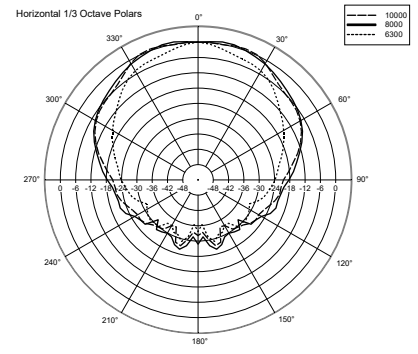
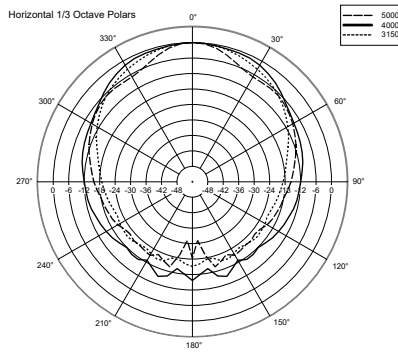
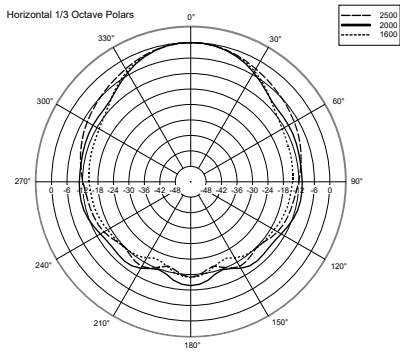
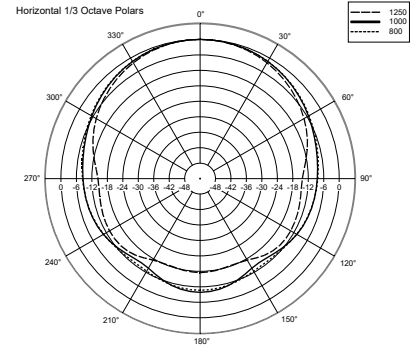
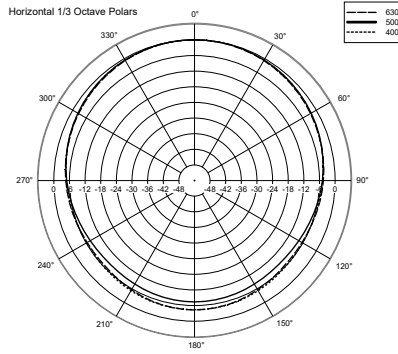
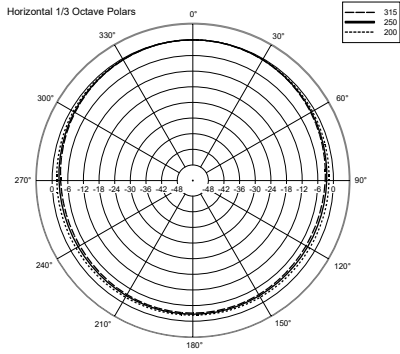

VERTICAL 1/3 POLAR PLOT

