

M 502

TWO-WAY PASSIVE SPEAKER

DESCRIPTION

M 502 is a multipurpose two-way twin-woofer full-range speaker system, suitable in a wide range of installations. The compactness, together with the elegant and neutral design with accurate finishing make M 502 suitable for almost any environment and architectural constraint. Available mounting accessories allow you to use the M 502 wall or ceiling mounted, with reference to the several possible applications.

The M 502 has a controlled coverage through its twin 5" and the precise constant directivity horn. The SPL and the level of undistorted sound the M 502 can reach is far above any expectation from such a compact solution. The M 502 features high sensitivity thanks to the use of oversized magnets and a comfortable sound quality with smooth and wide frequency response performed thanks to the Kapton diaphragm compression driver loaded with a constant directivity horn. The LICC crossover design includes an electronic protection on high frequency device.



FEATURES

- High Quality 2-way passive loudspeaker
- 2 x 5.5" woofer, vented
- 1 x 1" in driver, on 90°x90° CD horn
- High Power Handling 'Low Impedance Compensated Crossover', with electronic protection for the driver
- 100W AES power handling
- Steel Front Grille with robust double mesh polyester clothing
- Rotatable RCF front logo
- Installation points are available on the rear panel, top and bottom
- All models have a 4-pin EUROBLOCK connector (audio input and parallel link output)

TECHNICAL SPECIFICATIONS

Acoustical specifications	Frequency Response (-10dB):	80 Hz ÷ 20000 Hz
	Max SPL @ 1m:	116 dB
	Horizontal coverage angle:	90°
	Vertical coverage angle:	90°
	Directivity index Q:	9
	System Sensitivity:	92 dB
Power section	Nominal Impedance (ohm):	8 ohm
	Power Handling:	100 W RMS
	Peak Power Handling:	400 W PEAK
	Recommended Amplifier:	200 W
	Protections:	Dynamic active mosfet
	Crossover Frequencies:	2300 Hz
Transducers	Compression Driver:	1.0", 1.5" v.c
	Nominal Impedance (ohm):	8 ohm
	Input Power Rating:	25 W AES, 50 W PEAK
	Sensitivity:	106 dB, 1W @ 1m
	Woofers:	2 x 5.5", 1.2" v.c
	Nominal Impedance (ohm):	16 ohm
	Input Power Rating:	80 W AES, 160 W PEAK
Sensitivity:	88 dB, 1W @ 1m	
Input/Output section	Input connectors:	Euroblock
	Output connectors:	Euroblock
Standard compliance	CE marking:	Yes
Physical specifications	Cabinet/Case Material:	MDF
	Hardware:	6 x M6, 2 x M10
	Grille:	Steel with robust double mesh polyester clothing
	Color:	Black
Size	Height:	470 mm / 18.5 inches
	Width:	175 mm / 6.89 inches
	Depth:	185 mm / 7.28 inches
	Weight:	8 kg / 17.64 lbs
Shipping informations	Package Height:	539 mm / 21.22 inches
	Package Width:	257 mm / 10.12 inches
	Package Depth:	247 mm / 9.72 inches
	Package Weight:	8.8 kg / 19.4 lbs



PART NUMBER

- **13041011**

M 502

EAN 8024530007539

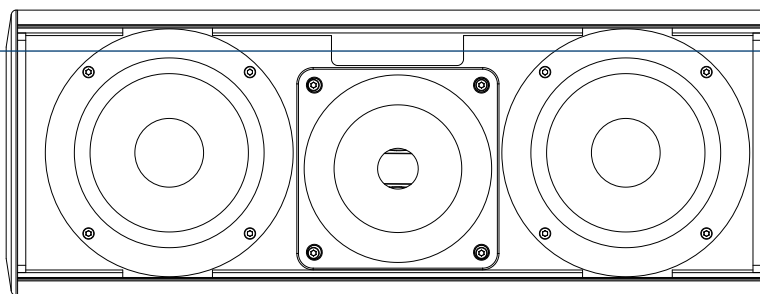

M502

470 [18.50"]

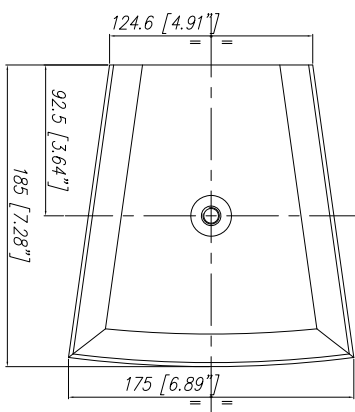
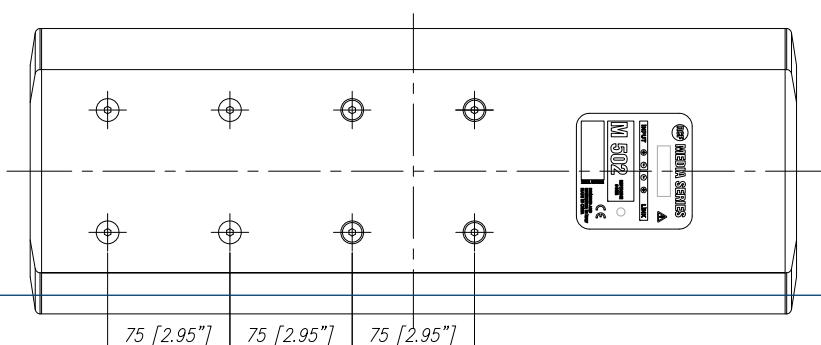
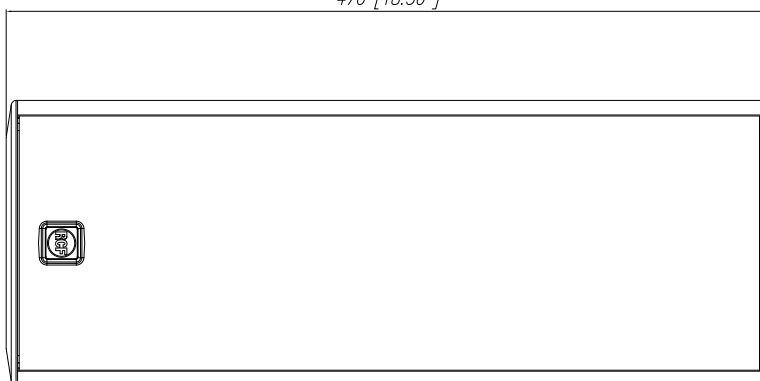

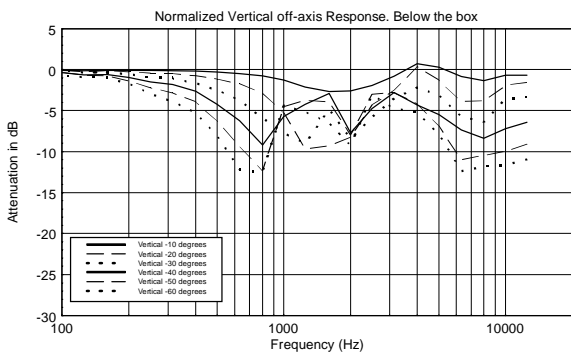
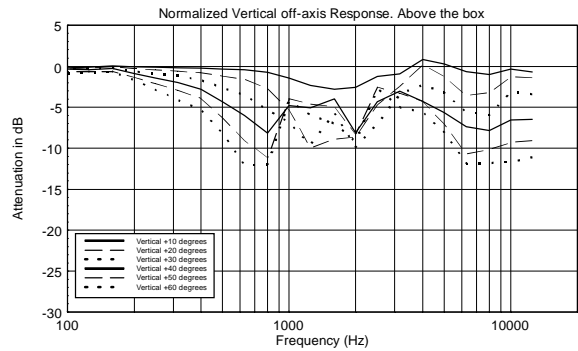
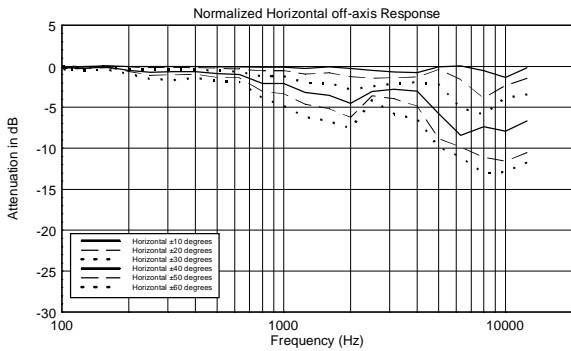
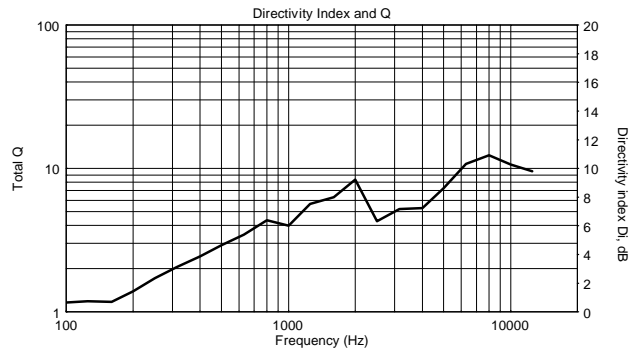
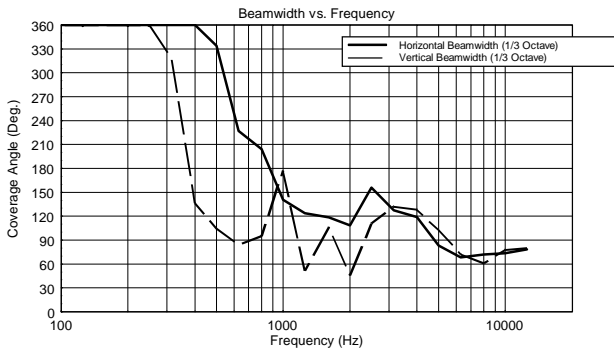
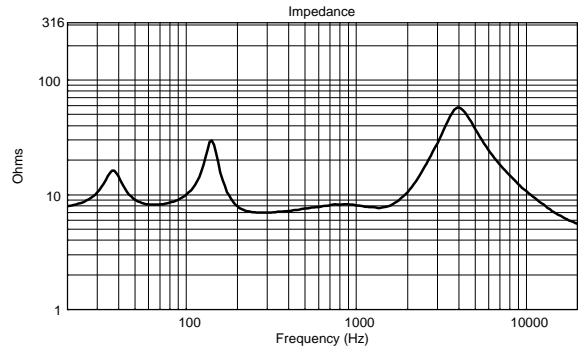
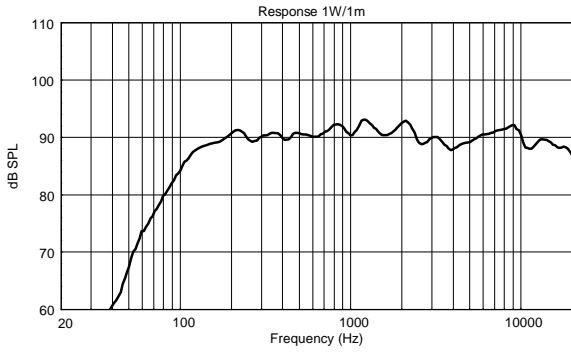

Horizontal 1/3 Octave Polars

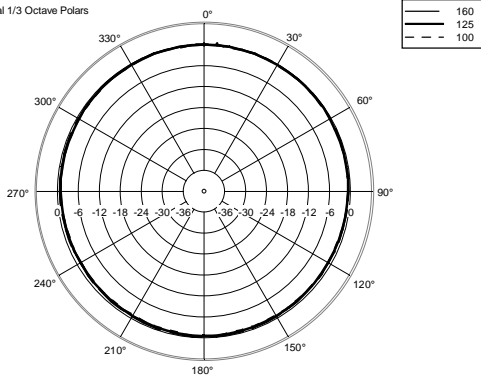

Horizontal 1/3 Octave Polars

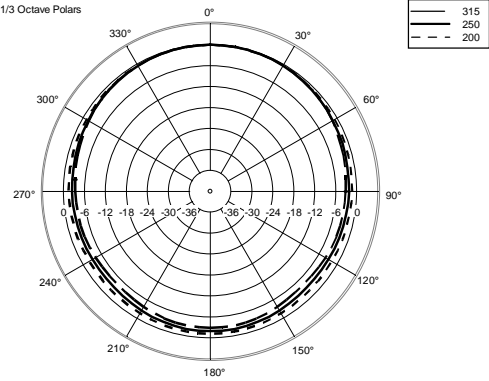

Horizontal 1/3 Octave Polars

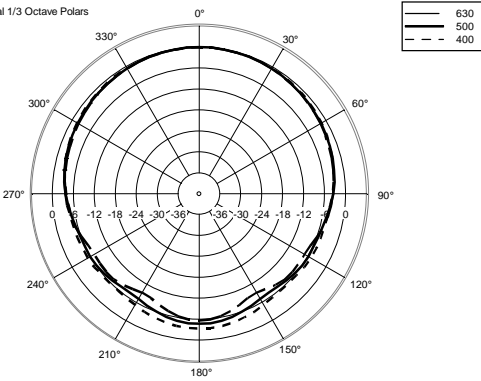

Horizontal 1/3 Octave Polars

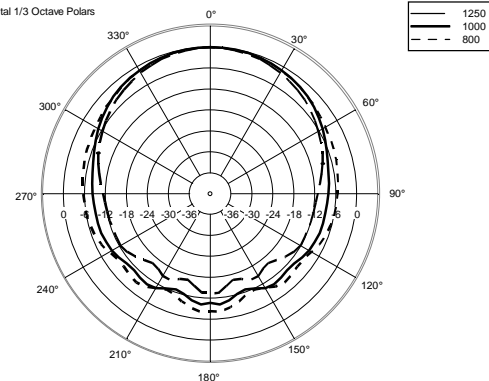

Horizontal 1/3 Octave Polars

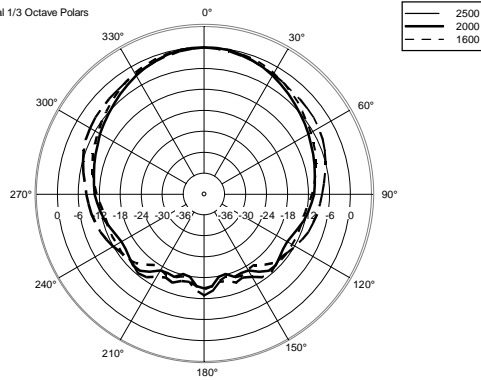

Horizontal 1/3 Octave Polars

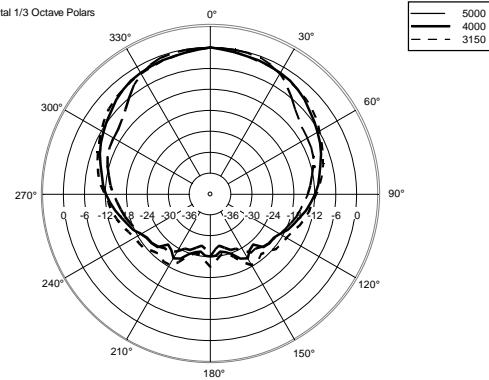

Horizontal 1/3 Octave Polars

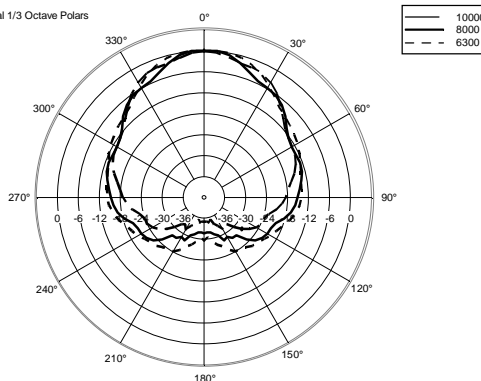

Horizontal One Octave Polars

