

COMPACT M 12

TWO-WAY PASSIVE SPEAKER

DESCRIPTION

COMPACT M 12 is a multipurpose two-way full-range speaker system, suitable for a wide range of applications. Its balanced sound is a big asset in near-field applications for the best intelligibility. The M 12 features high sensitivity, typical of professional audio cabinets thanks to the use of oversized magnets and a HI-FI sound quality, with smooth and wide frequency response, thanks to the wave-guided compression driver. The SPL level of low-distortion audio the M 12 can provide goes far beyond expectations of such a compact solution. The elegant and compact design with accurate finishing makes M 12 suitable for almost any environment, even with architectural constraints. Optional mounting accessories allow using M 12 on wall or ceiling installations.



FEATURES

- 300 W RMS power handling
- 129 dB max SPL
- 55 ÷ 20000 Hz frequency range
- 90° x 70° constant directivity coverage angle
- 1 x 12" high power woofer
- 1 x 1.4" voice coil compression driver
- High quality plywood cabinet
- Steel front grille with clothing
- Installation points available on rear, top and bottom panels
- 4 pole EUROBLOCK connector (audio input and parallel link output)

TECHNICAL SPECIFICATIONS

Acoustical specifications	Frequency Response (-10dB):	55 Hz ÷ 20000 Hz
	Max SPL @ 1m:	129 dB
	Horizontal coverage angle:	90°
	Vertical coverage angle:	70°
	Directivity index Q:	9
	System Sensitivity:	98 dB
Power section	Nominal Impedance (ohm):	8 ohm
	Power Handling:	300 W RMS
	Peak Power Handling:	1200 W PEAK
	Recommended Amplifier:	600 W
	Protections:	Dynamic active mosfet
	Crossover Frequencies:	1800 Hz
Transducers	Compression Driver:	1 x 1.0", 1.4" v.c
	Nominal Impedance (ohm):	8 ohm
	Input Power Rating:	25 W AES, 50 W PROGRAM POWER
	Sensitivity:	107 dB, 1W @ 1m
	Woofer:	12", 2.5" v.c
	Nominal Impedance (ohm):	8 ohm
	Input Power Rating:	300 W AES, 600 W PROGRAM POWER
	Sensitivity:	98 dB, 1W @ 1m
Input/Output section	Input connectors:	Euroblock
	Output connectors:	Euroblock
Standard compliance	CE marking:	Yes
Physical specifications	Cabinet/Case Material:	Plywood
	Hardware:	8 x M8, 8 x M10
	Grille:	Steel with clothing
	Color:	Black
Size	Height:	620 mm / 24.41 inches
	Width:	362 mm / 14.25 inches
	Depth:	404 mm / 15.91 inches
	Weight:	22 kg / 48.5 lbs
Shipping informations	Package Height:	655 mm / 25.79 inches
	Package Width:	442 mm / 17.4 inches
	Package Depth:	400 mm / 15.75 inches
	Package Weight:	25.5 kg / 56.22 lbs



PART NUMBER

- **13000596**
COMPACT M 12
Black
EAN 8024530017811

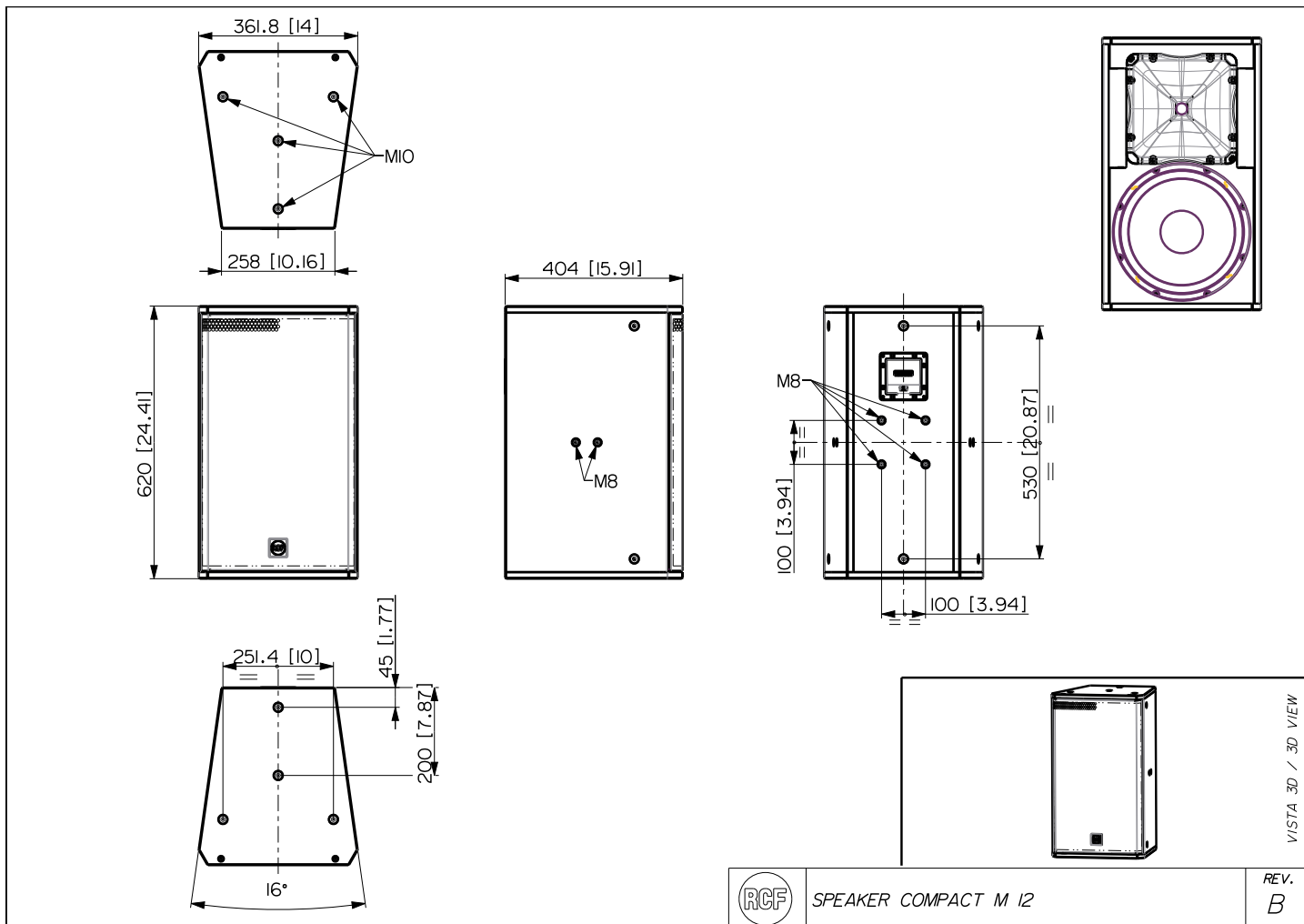

SPEAKER COMPACT M 12

REV.
B

VISTA 3D / 3D VIEW

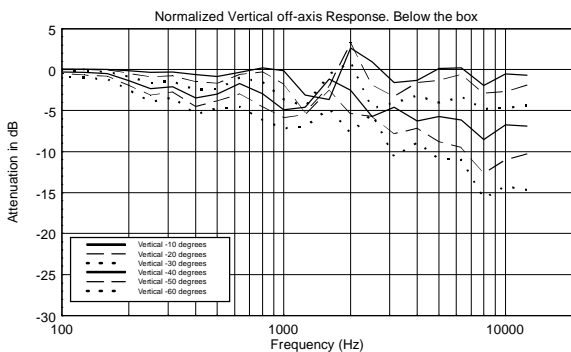
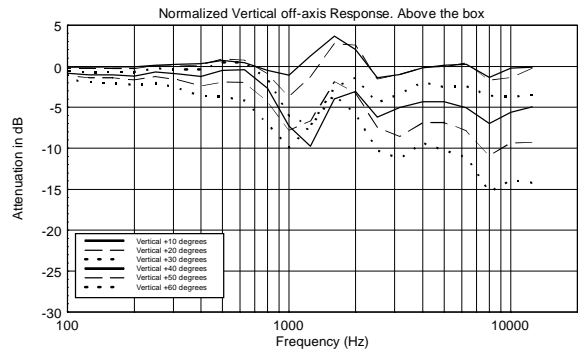
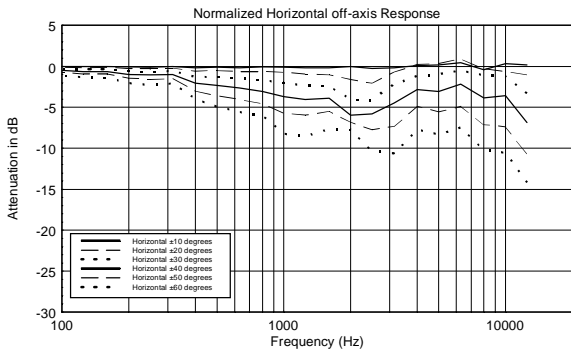
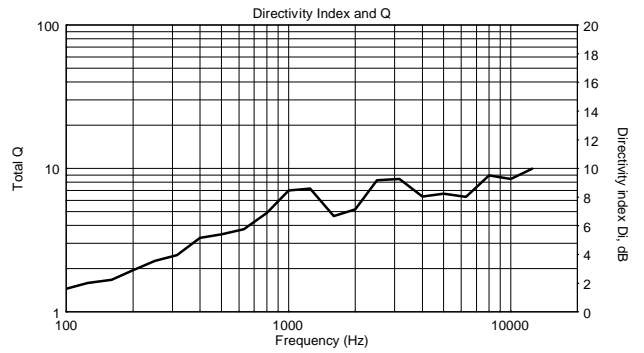
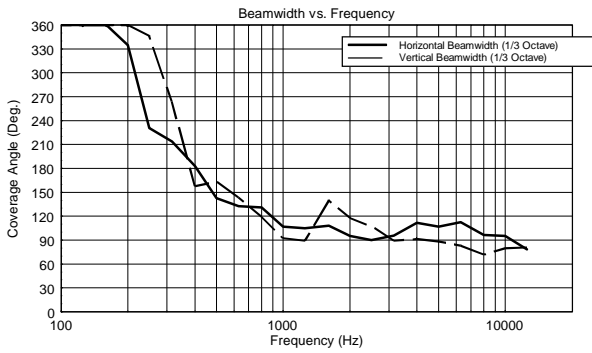
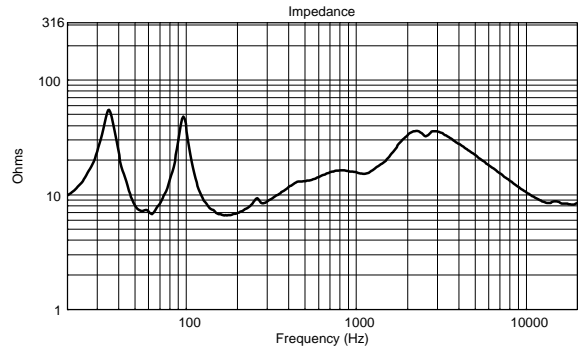
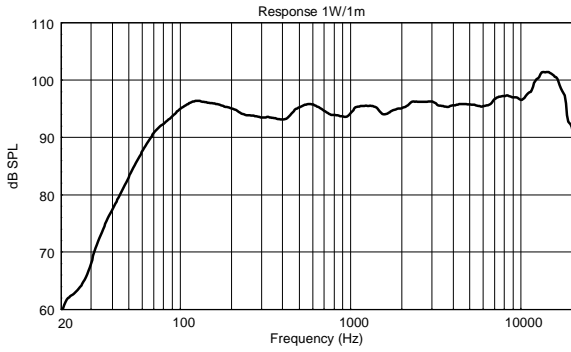

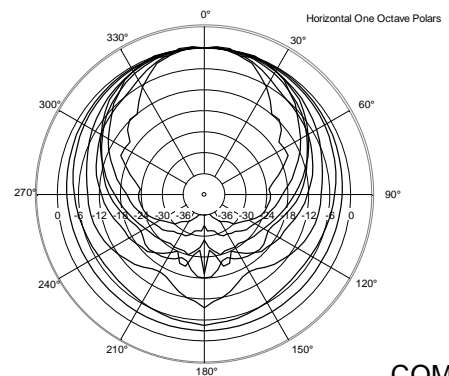
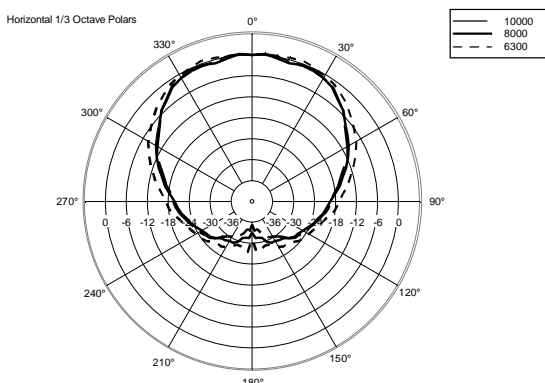
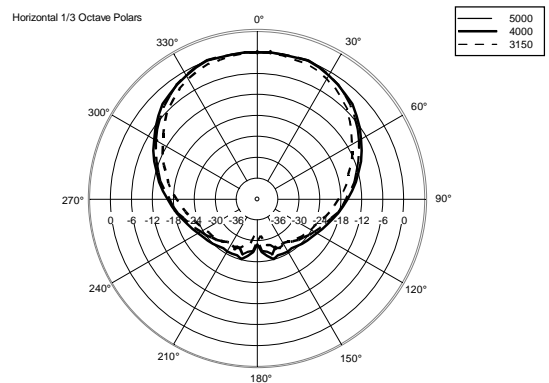
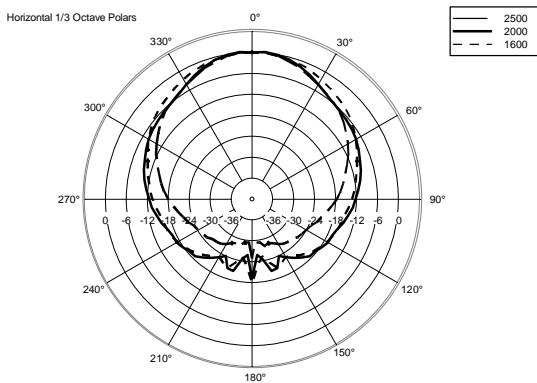
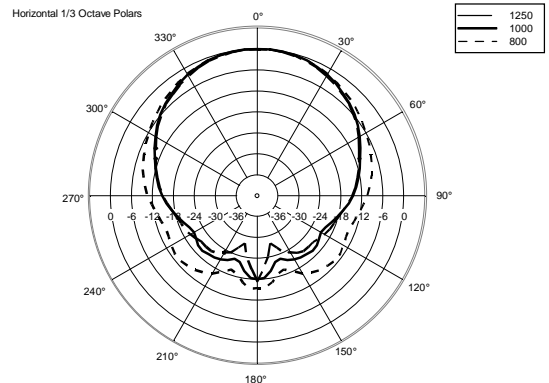
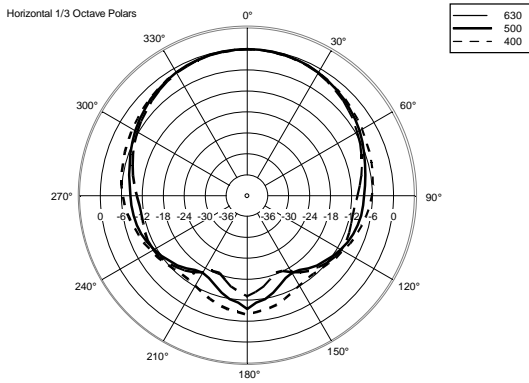
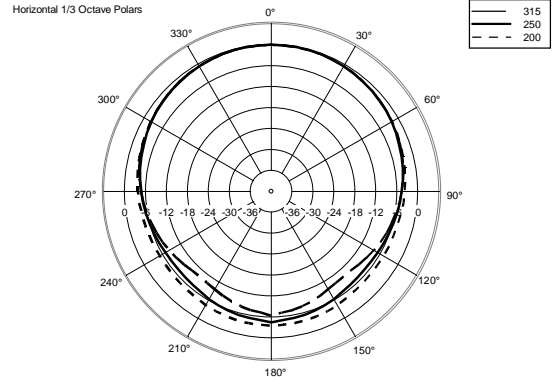
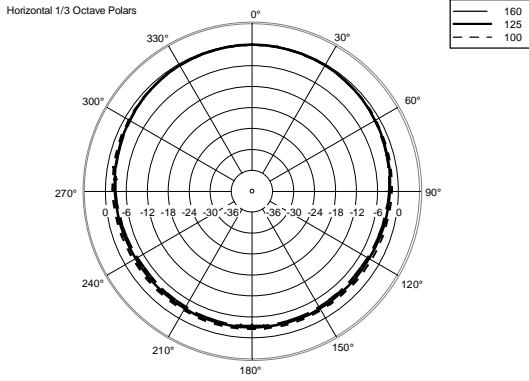

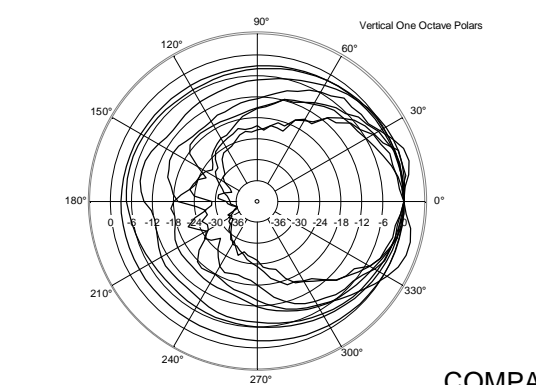
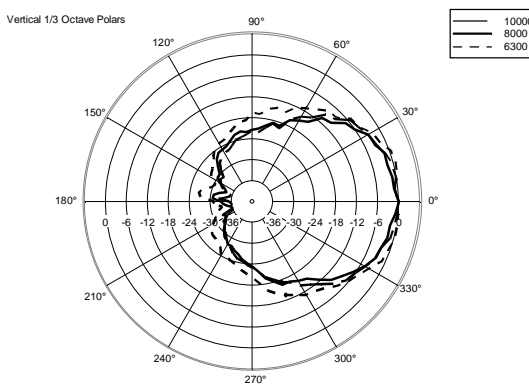
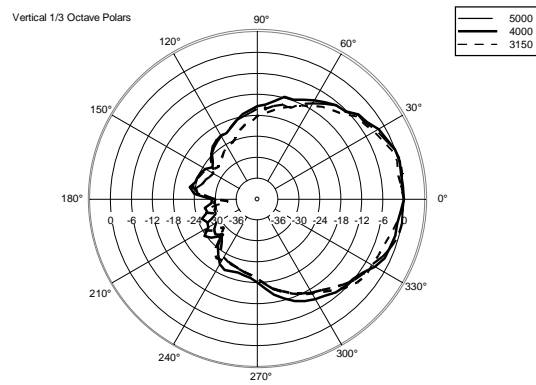
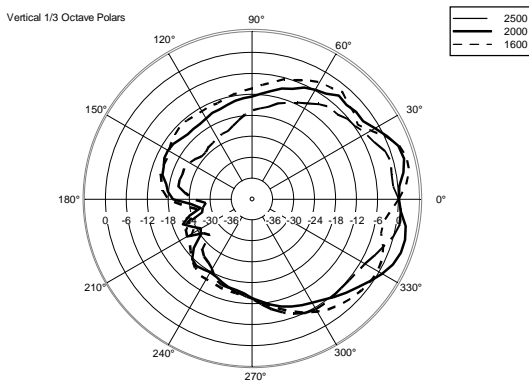
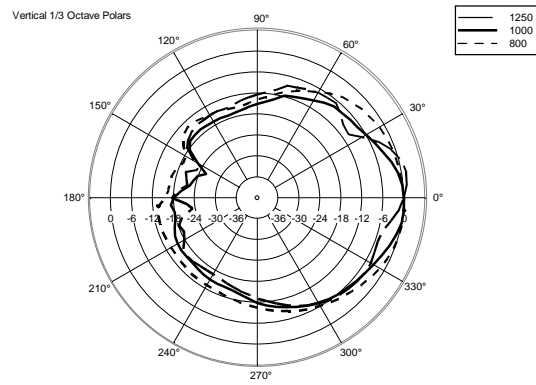
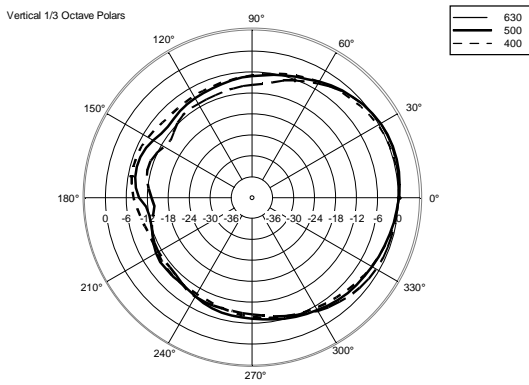
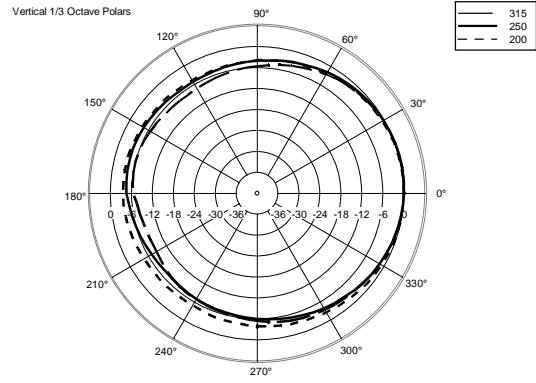
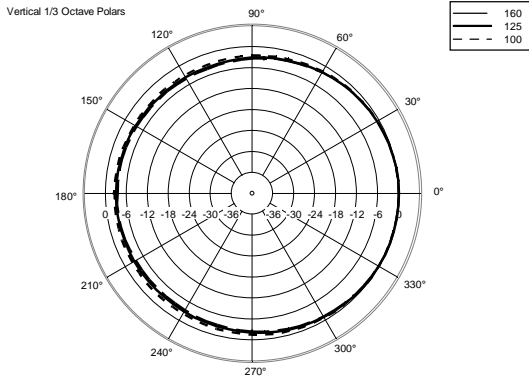

ACCESSORIES

AC WM-C WALL MOUNT FOR NEW COMPACT

PART NUMBER **13360199**
EAN: 8024530007355

HORIZONTAL BRACKET H-BR 2X COMPACT M 12

PART NUMBER **13360445**
EAN: 8024530018283

PANEL PNL IN-OUT SPEAKON

PART NUMBER **12399062**
EAN:

VERTICAL BRACKET V-BR 2X COMPACT M 12

PART NUMBER **13360448**
EAN: 8024530018313