

# ART 708-A MK4

## ACTIVE TWO-WAY SPEAKER

### DESCRIPTION

ART 708-A MK4 is a unique product in its category. The 1.0" compression driver offers unique vocal clarity and sound projection. The 8" woofer offers an extremely linear response and a precise, deep low frequency control. The transducers are produced using the most advanced assembly technologies. The amplifier delivers 800 watts and is controlled by a DSP that takes care of crossover, equalisation, phase control, soft limiting and speaker protections.



### FEATURES

- 127 dB Max SPL
- 800 WATT 2-way peak power
- 90 x 70, Wide dispersion constant directivity horn
- Innovative DSP Processing
- 1" Compression Driver, 1.0" v.c.
- 8" Woofer
- FiRPHASE Technology

## TECHNICAL SPECIFICATIONS

<b>Acoustical specifications</b>	Frequency Response:	60 Hz ÷ 20000 Hz
	Max SPL @ 1m:	127 dB
	Horizontal coverage angle:	90°
	Vertical coverage angle:	70°
<b>Transducers</b>	Compression Driver:	1 x 1.0", 1.0" v.c
	Woofers:	8", 2.0" v.c
<b>Input/Output section</b>	Input signal:	bal/unbal
	Input connectors:	XLR, Jack
	Output connectors:	XLR
	Input sensitivity:	-2 dBu/+4 dBu
	Mic. Input Sensitivity:	-32 dBu
<b>Processor section</b>	Crossover Frequencies:	1600 Hz
	Protections:	Thermal, RMS
	Limiter:	Soft Limiter
	Controls:	Volume, Boost, Mic/Line
<b>Power section</b>	Total Power:	800 W Peak, 400 W RMS
	High frequencies:	200 W Peak, 100 W RMS
	Low frequencies:	600 W Peak, 300 W RMS
	Cooling:	Convection
	Connections:	VDE
<b>Standard compliance</b>	CE marking:	Yes
<b>Physical specifications</b>	Cabinet/Case Material:	PP Composite
	Hardware:	2 x M10
	Handles:	1 Top
	Pole mount/Cap:	Yes
	Grille:	Steel
	Color:	Black
<b>Size</b>	Height:	480 mm / 18.9 inches
	Width:	291 mm / 11.46 inches
	Depth:	276 mm / 10.87 inches
	Weight:	10.4 kg / 22.93 lbs
<b>Shipping informations</b>	Package Height:	520 mm / 20.47 inches
	Package Width:	331 mm / 13.03 inches
	Package Depth:	346 mm / 13.62 inches
	Package Weight:	12.2 kg / 26.9 lbs



**PART NUMBER**

• **13000519**

ART 708-A MK4

115V

EAN 8024530015077

• **13000518**

ART 708-A MK4

220-240V

EAN 8024530014803

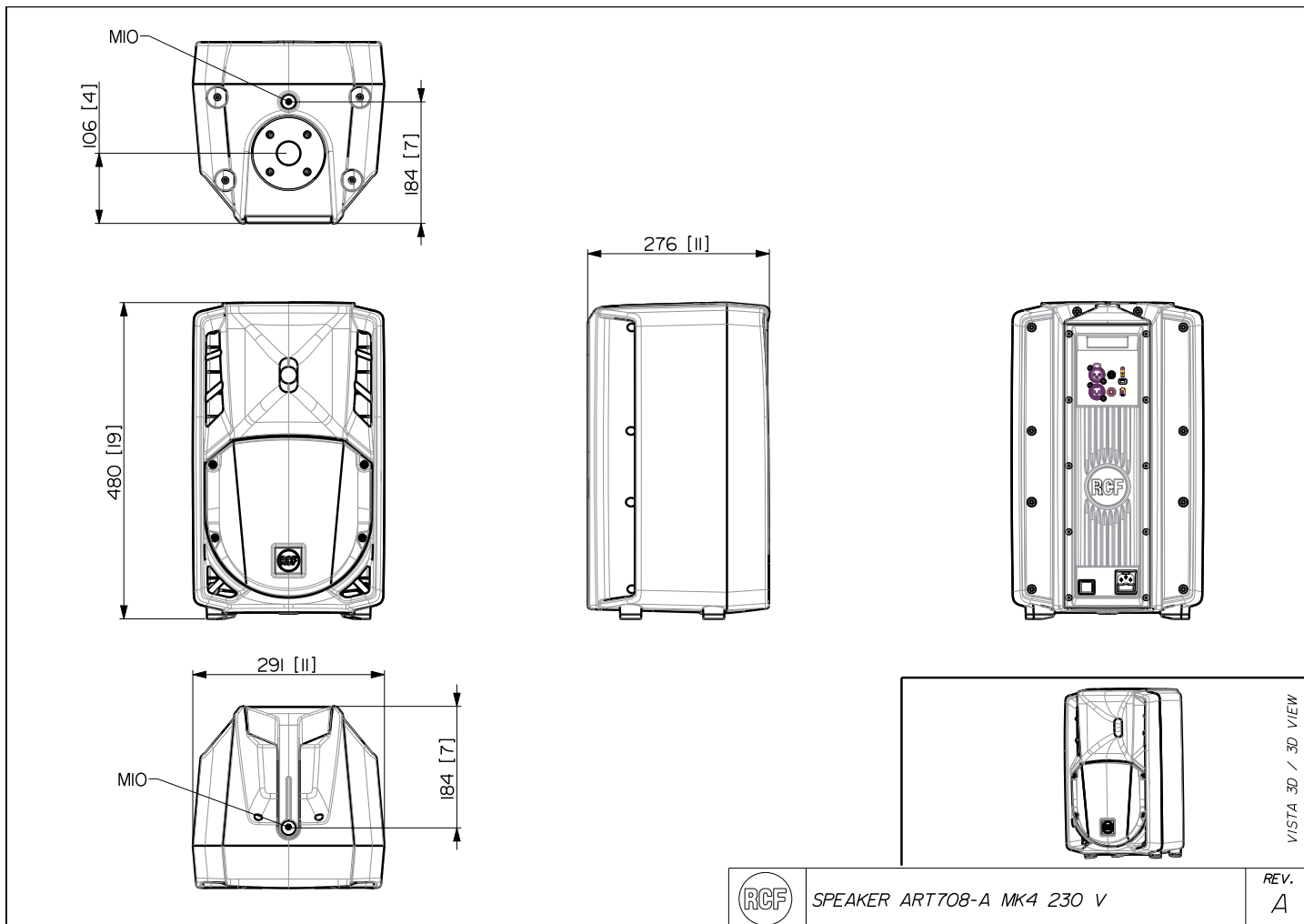

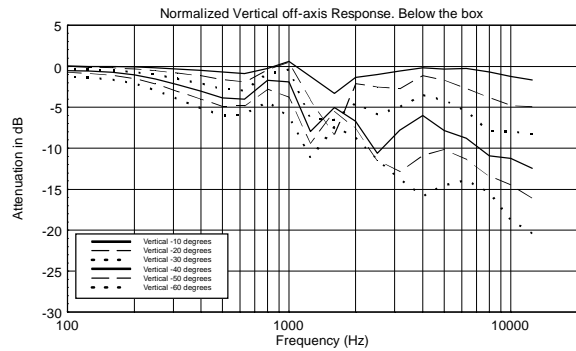
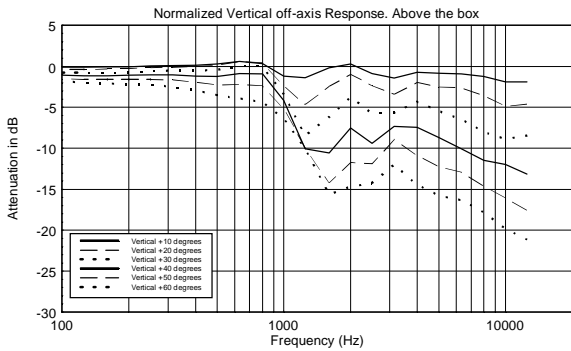
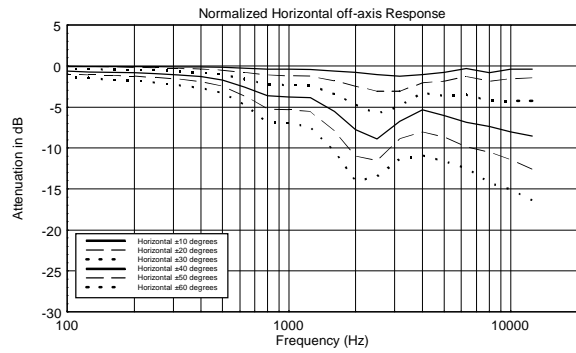
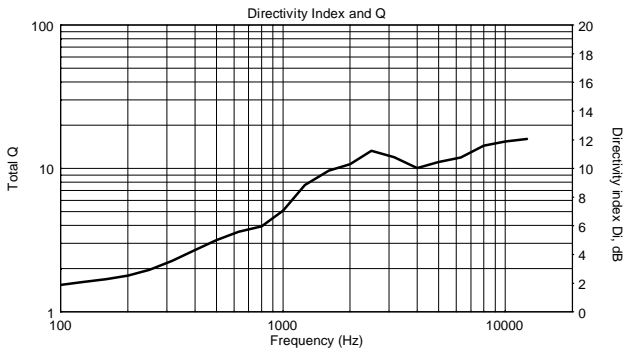
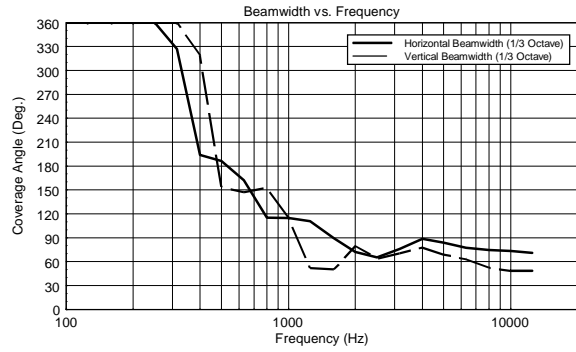
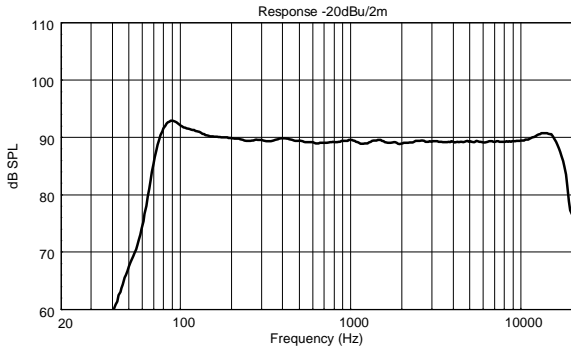

Horizontal 1/3 Octave Polars

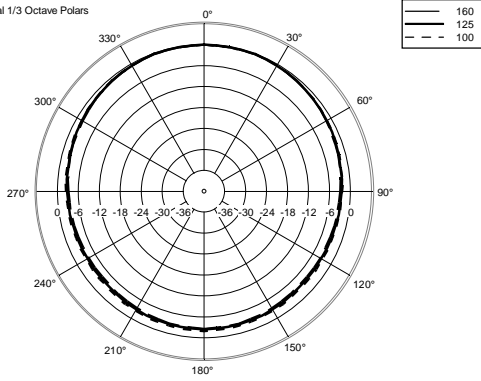

Horizontal 1/3 Octave Polars

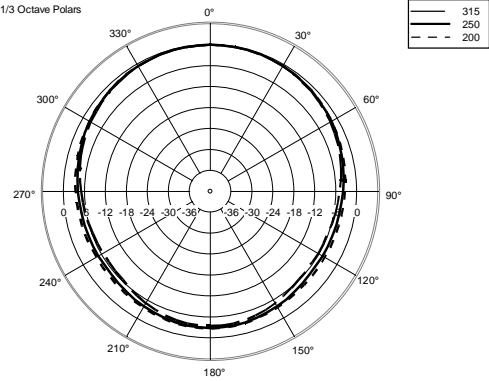

Horizontal 1/3 Octave Polars

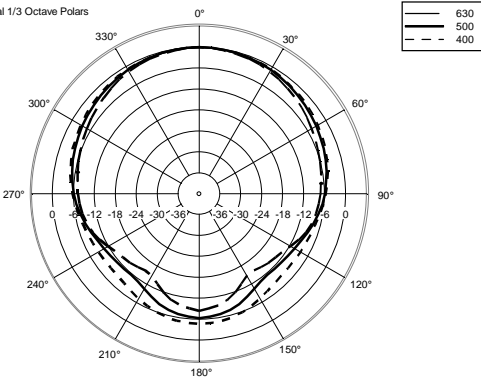

Horizontal 1/3 Octave Polars

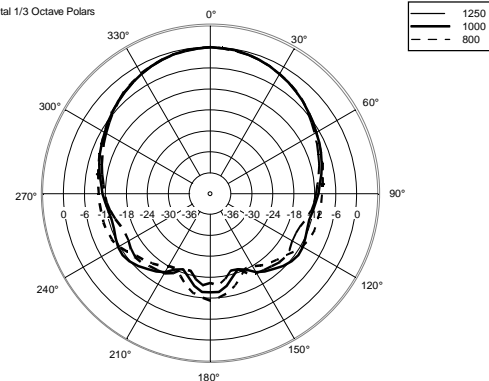

Horizontal 1/3 Octave Polars

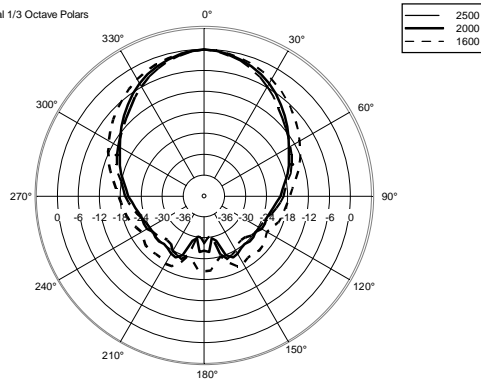

Horizontal 1/3 Octave Polars

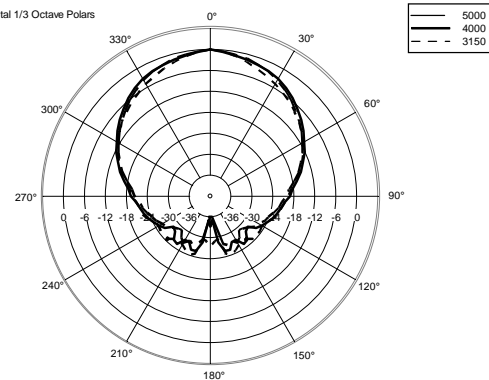

Horizontal 1/3 Octave Polars

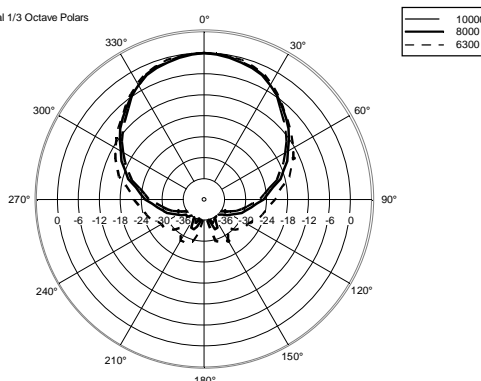

Horizontal One Octave Polars

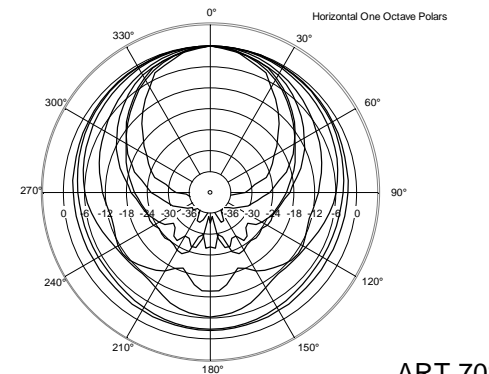

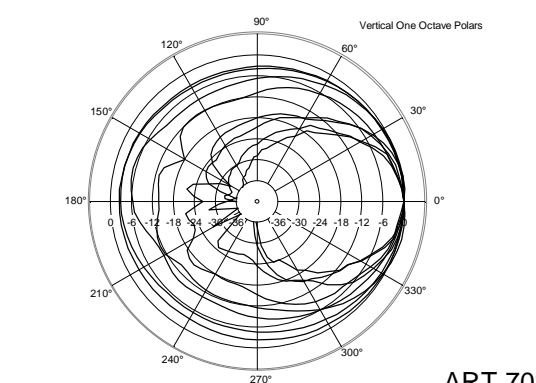
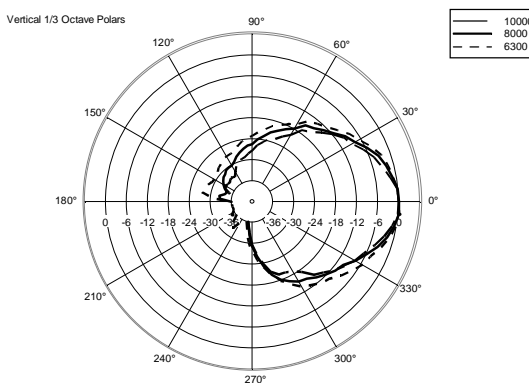
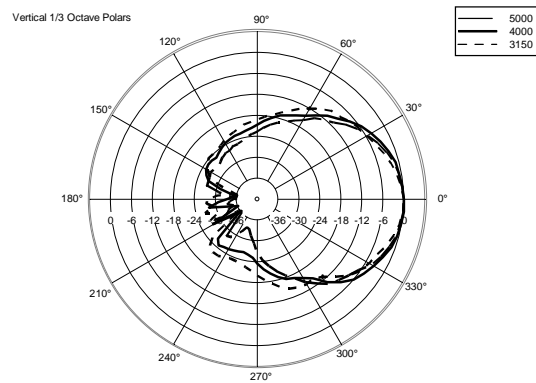
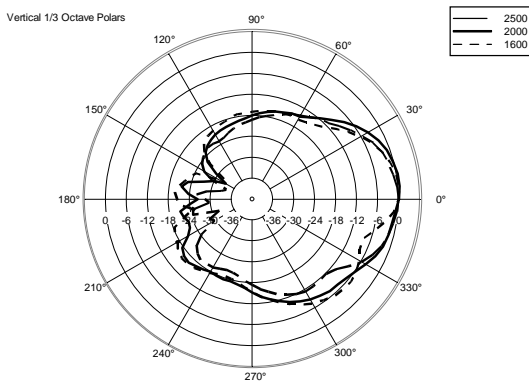
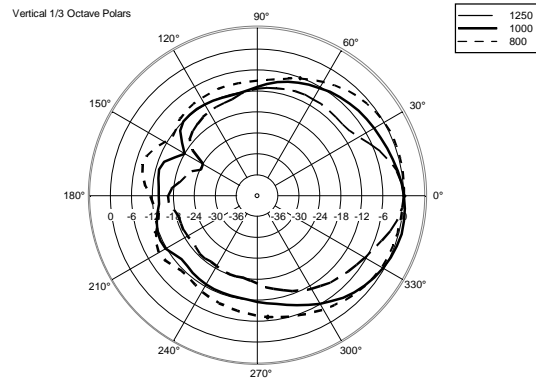
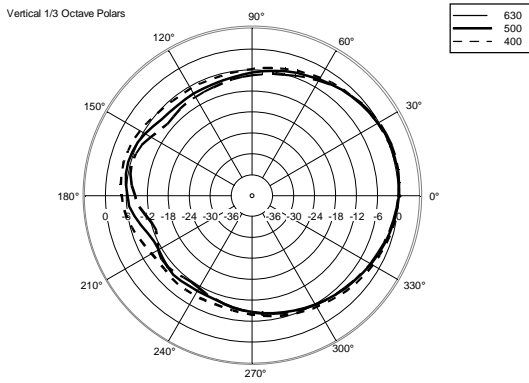
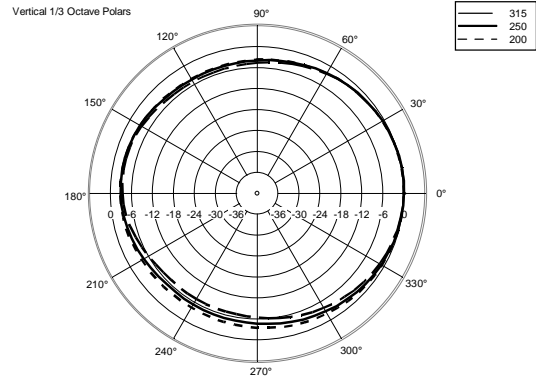
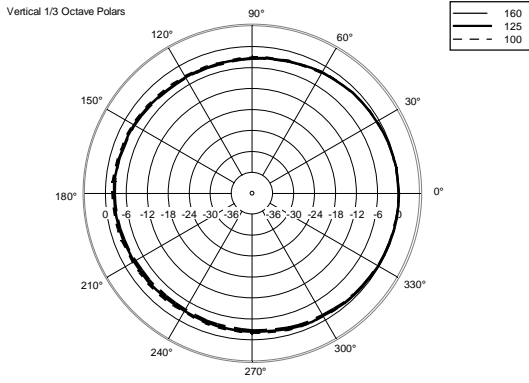

## ACCESSORIES

	AC PMA - POLE MOUNT	PART NUMBER EAN:	<b>13360034</b> 8024530007713
	AC PM-M20	PART NUMBER EAN:	<b>13360067</b> 8024530014599
	AC PMX POLE MOUNT M20	PART NUMBER EAN:	<b>13360232</b> 8024530010058
	AC PRO-FS PROFESS. LOCKING FLOOR STAND	PART NUMBER EAN:	<b>13360109</b> 8024530006471
	AC PRO-LF PROFESSIONAL LOCKING FLANGE	PART NUMBER EAN:	<b>13360111</b> 8024530006495
	AC PRO-PM PROFESS. LOCKING POLE MOUNT	PART NUMBER EAN:	<b>13360110</b> 8024530006488
	AC XLR-3M3F XLR CONN. 3MALE3FEMALEXCABLE	PART NUMBER EAN:	<b>13360102</b> 8024530006402
	COVER CVR ART 708	PART NUMBER EAN:	<b>13360166</b> 8024530010706
	SPEAKER CABINET FLOOR STAND-STEEL	PART NUMBER EAN:	<b>13360035</b> 8024530005030