



HiMaxx
Speaker Systems

ENGLISH

INDEX

<i>IMPORTANT SAFETY INSTRUCTIONS</i>	<i>1</i>
<i>GENERAL FEATURES</i>	<i>2</i>
<i>DIMENSIONS</i>	<i>3</i>
<i>CONNECTIONS</i>	<i>4</i>
<i>ACCESSORIES</i>	<i>5</i>
<i>WALL BRACKETS ASSEMBLY INSTRUCTIONS</i>	<i>6</i>
<i>POWER SUPPLY</i>	<i>7</i>
<i>CONTROLS AND FUNCTIONS</i>	<i>8-9-10-11</i>
<i>CONNECTION EXAMPLES</i>	<i>12-13-14-15</i>
<i>DIAGRAMS</i>	<i>16-17-18-19-20</i>
<i>BLOCK DIAGRAMS</i>	<i>21-22</i>
<i>TECHNICAL SPECIFICATIONS</i>	<i>23-24</i>



WARNING

RISK OF ELECTRIC SHOCK
DO NOT OPEN



**TO REDUCE THE RISK OF ELECTRIC SHOCK
DO NOT REMOVE COVER (OR BACK)
NO USER SERVICEABLE PARTS INSIDE
REFER SERVICING TO QUALIFIED SERVICE PERSONNEL**

**TO REDUCE THE RISK OF FIRE OR ELECTRIC SHOCK
DO NOT EXPOSE THIS EQUIPMENT TO RAIN OR MOISTURE**



WHERE MARKED, THIS SYMBOL INDICATES A DANGEROUS NON-ISOLATED VOLTAGE INSIDE THE LOUDSPEAKER:
SUCH VOLTAGE COULD BE SUFFICIENT TO RESULT IN THE RISK OF ELECTRIC SHOCK.



WHERE MARKED, THIS SYMBOL INDICATES IMPORTANT USAGE AND MAINTENANCE INSTRUCTIONS IN THE ENCLOSED DOCUMENTS. PLEASE REFER TO THE MANUAL.

IMPORTANT SAFETY INSTRUCTIONS

- 1) Read these instructions
- 2) Keep these instructions
- 3) Heed all warnings
- 4) Follow all instructions
- 5) Do not use this apparatus near water
- 6) Clean only with dry cloth
- 7) Do not block any ventilation openings. Install in accordance with the manufacturer's instructions.
- 8) Do not install near any heat sources, such as radiators, heat registers, stoves or other apparatus (including amplifiers) that produce heat
- 9) Do not defeat the safety purpose of the polarized or grounding-type plug. A polarized plug has two blades with one wider than the other. A grounding type plug has two blades and a third grounding prong. The wide blade or the third prong are provided for your safety. If the provided plug does not fit into your outlet, consult an electrician for replacement of the obsolete outlet.
- 10) Protect the power cord from being walked on or pinched particularly at plugs, convenience receptacles, and the point where they exit from the apparatus.
- 11) Only use attachments/accessories specified by the manufacturer.
- 12) Use only with the cart, stand, tripod, bracket, or table specified by the manufacturer or sold with the apparatus. When a cart is used, use caution when moving the cart/apparatus combination to avoid injury from tip-over.
- 13) Unplug this apparatus during lightning storms or when unused for long periods of time.
- 14) Refer all servicing to qualified service personnel. Servicing is required when the apparatus has been damaged in any way, such as power-supply cord or plug is damaged, liquid has been spilled or objects have fallen into the apparatus, the apparatus has been exposed to rain or moisture, does not operate normally, or has been dropped.



THE DEVICE MUST BE CONNECTED TO THE MAINS THROUGH A POWER OUTLET WITH A PROTECTIVE EARTH CONNECTION.

This device features a power outlet ; install the device so that the outlet for the power cord is easily accessible .

PRECAUTIONS

- For proper air ventilation please make sure to leave sufficient clearance (min 11 inc.) on all sides of the device.
- Please do not cover the ventilation slots with papers, table cloths, curtains, etc. in order not to prevent ventilation of the device.
- Please do not place any naked flame source, such as lighted candles, on the device.
- Please keep the device away from water springs and splashes and please do not place any objects containing liquids, such as vases, on the device.
- CAUTION:** To avoid the risk of injuries please secure the device to the wall following the enclosed instructions.

GENERAL FEATURES

With the new HiMaxX series, FBT establishes a reference point on the scenario of 12" and 15" enclosures in polypropylene for sound reinforcement, introducing performance and technical content of a standard unthinkable up until now.

FBT HiMaxX takes its place alongside the FBMaxX series, exalting all the technical features.

The study of a new cabinet in polypropylene, the use of a switch mode power supply and high efficiency power amplifiers and the redesign of the loudspeakers were the activities of the FBT R&D team aimed at maximizing the power weight ratio.

Compact and light weight, HiMaxX brilliantly solve all the most demanding requests from buffs, musicians and professionals looking for powerful, versatile and very high quality loudspeaker enclosures. Ideal for live and sound reinforcement applications requiring ease of transport, they are also suited to fixed installations, thanks to the cabinets' format and optional accessories.

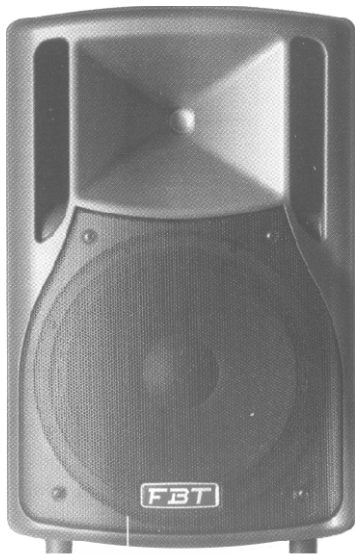

HiMaxX 40A

2-way bi-amplified

Sturdy cabinet in polypropylene
B&C custom designed 12" neod. woofer
500W RMS PWM LF power amplifier
150W RMS HF power amplifier
Switch mode power supply

HiMaxX 40

Sound reinforcement speaker
500W / 8 Ohm
Passive crossover filter

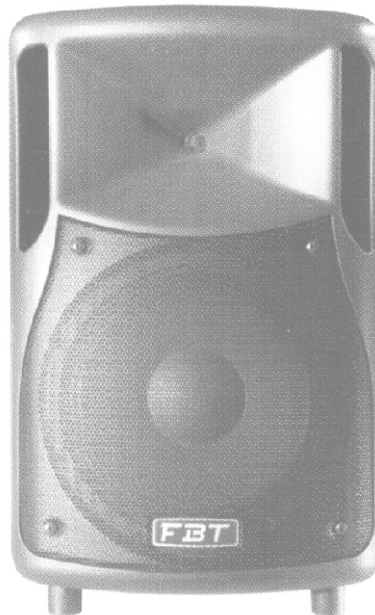

HiMaxX 60A

2-way bi-amplified

Sturdy cabinet in polypropylene
B&C custom designed 15" neod. woofer
700W RMS PWM LF power amplifier
200W RMS HF power amplifier
Switch mode power supply

HiMaxX 60

Sound reinforcement speaker
700W / 8 Ohm
Passive crossover filter



HiMaxX 100SA

Processed active subwoofer
0,7" birch plywood enclosure
18" custom neodymium B&C woofer
Built-in 1200W RMS PWM amplifier
Switch mode power supply

DIMENSIONS

HiMaxX 40A / 40

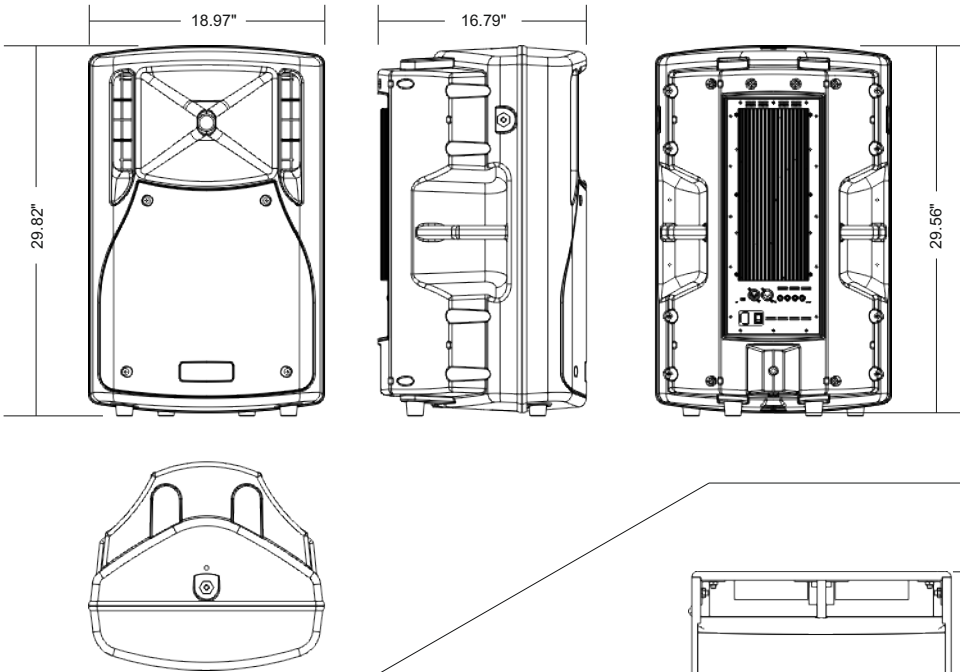
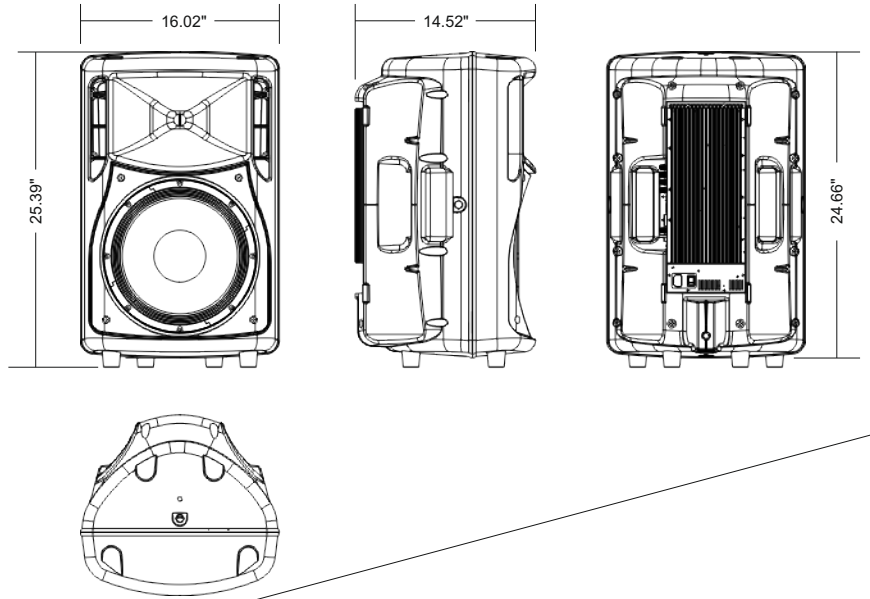

HiMaxX 60A / 60

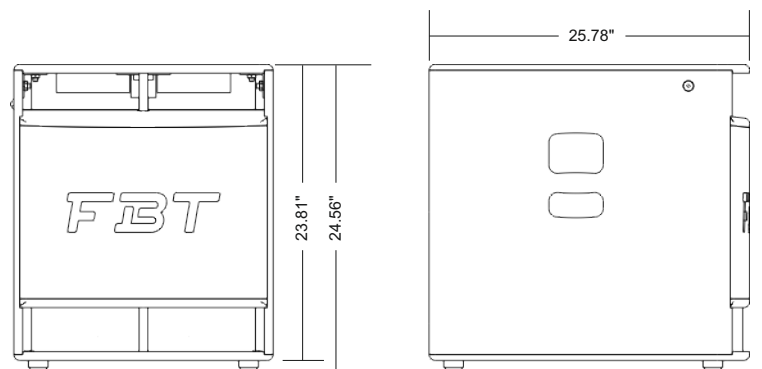

HiMaxX 100SA

CONNECTIONS

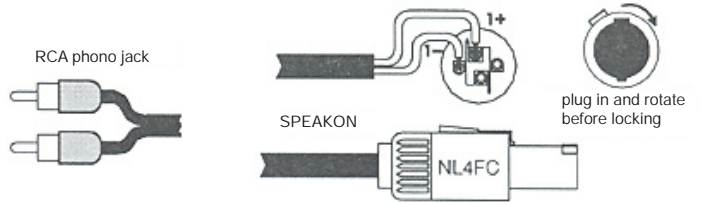
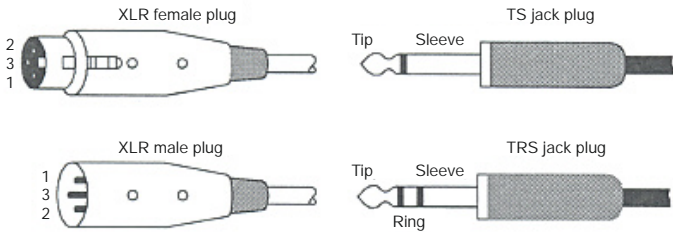

The 3-pole XLR connectors are almost always used for conducting mono-balanced signals; the three poles correspond respectively to ground (1), the positive signal (2) and the negative signal (3).

SPEAKON is a connector which is specially adapted for connecting power terminals to loudspeakers; when inserted in an appropriate socket, it locks so as to prevent accidental disconnection; moreover, it is equipped with protection against electrical shocks and guarantees the correct polarisation.

The RCA cannot be balanced as they have just two poles: signal (central point) and ground (perimeter); they are therefore unbalanced mono connectors.

The JACKS are typical connectors for the transporting of two separate signals through two channels, left and right, using a single connector and therefore they can be either mono or stereo. Mono jacks (TS), also known as unbalanced jacks, are recognisable from stereo or balanced jacks (TRS) by their composition. The point of the mono jacks is divided into two parts, tip and ground (Tip and Slave) to which the two poles are connected; the stereo or balanced jacks are divided in three parts, as they have a central ring (Ring) which is connected to a second wire, the third (negative) pole.

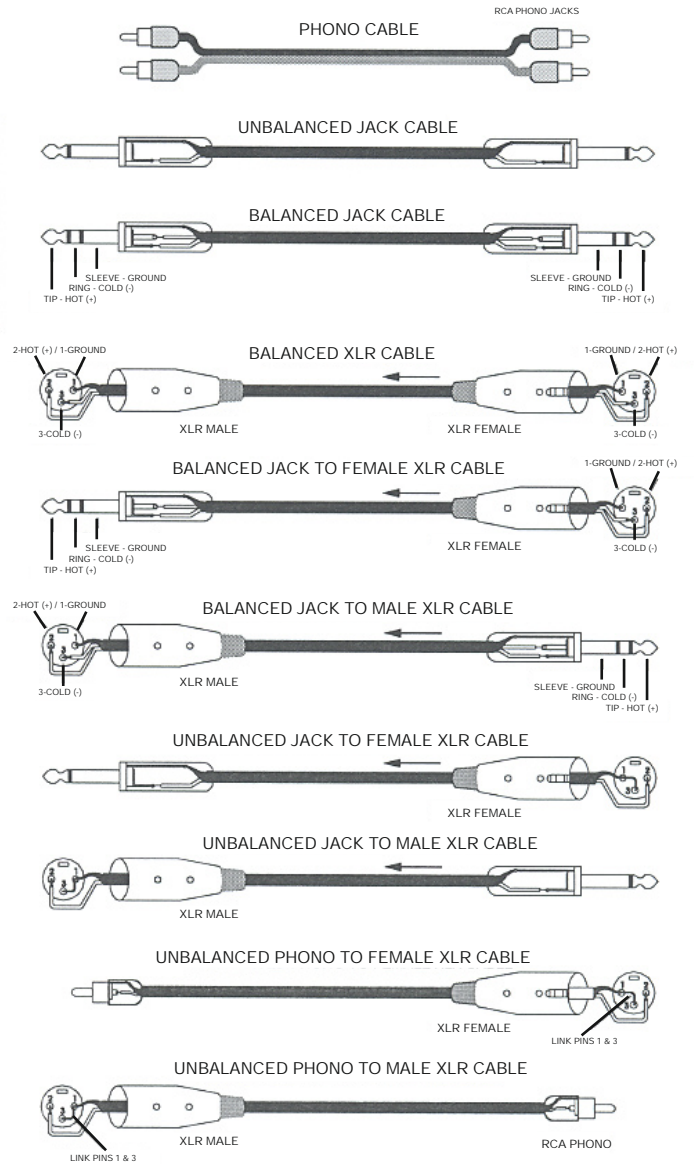

ACCESSORIES

CAUTION

The FBTHiMaxX speakers use only with mount for wall installation model BOX100 and BOX101. **Use with other mounts is capable of resulting in instability causing possible injury.**



For wall- or ceiling-mounting, use only the specially provided anchoring points and do not hang the speaker using elements that are not appropriate or suitable for this purpose. Furthermore, check the suitability of the supports (wall, ceiling, framework, etc.) and of the fixing components (plugs, screws, brackets not provided by FBT): they shall guarantee the safety for the people and for the installation, also considering, for instance, the mechanical vibrations normally generated by a transducer.

Mod. BOX100 (code 10187)
(HORIZONTAL)

HiMaxX40 / 40A

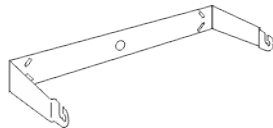

Mod. BOX101 (code 10188)
(VERTICAL)

HiMaxX40 / 40A

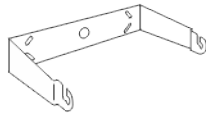

Mod. BOX104 (code 15771)
(HORIZONTAL)

HiMaxX60 / 60A

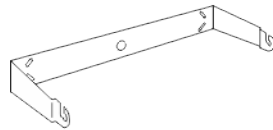

Mod. BOX105 (code 15772)
(VERTICAL)

HiMaxX60 / 60A

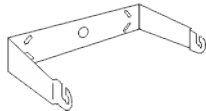

DO NOT STACK MORE THAN TWO SPEAKER SYSTEMS

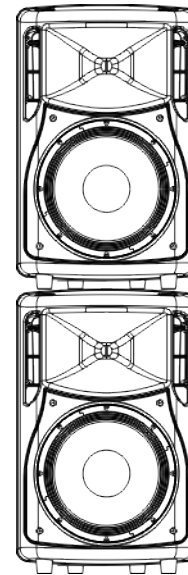

HiMaxX100SA

Preset for mounting 4 optional wheels (Ø 3.14")

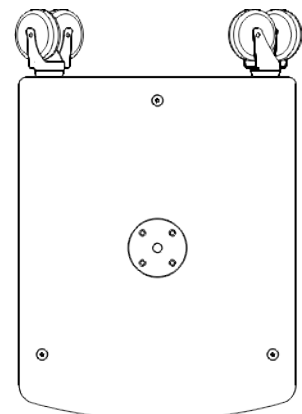
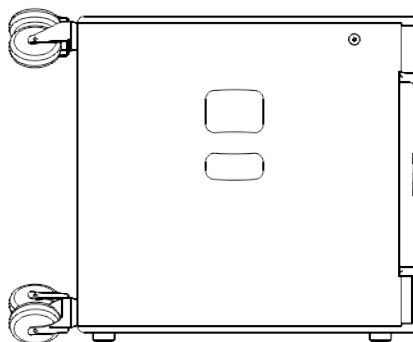
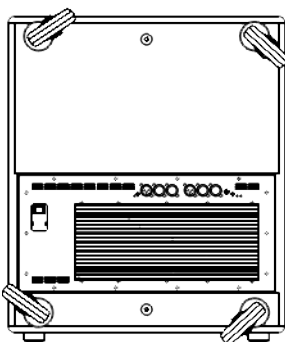

WALL BRACKET ASSEMBLY INSTRUCTIONS



TO AVOID DAMAGE OR PHYSICAL INJURY ALWAYS ENSURE THAT THE SYSTEM IS EQUIPPED WITH A SAFETY CHAIN WHEN THE BOX IS SECURED TO THE WALL

Mod. BOX100 (code 10187) (HORIZONTAL)

1. Take care when selecting the place of speaker installation; ensure the structure is adequate to withstand the weight of the box; fix the base of the bracket to the wall using suitable screws in all bracket fixing holes.
2. Position the speaker between the two bracket arms and secure by means of the two M10 threaded inserts
3. Rotate the speaker to the required position using the M6 threaded insert

Mod. BOX101 (code 10188) (VERTICAL)

1. Take care when selecting the place of speaker installation; ensure the structure is adequate to withstand the weight of the box; fix the base of the bracket to the wall using suitable screws in all bracket fixing holes.
2. Position the speaker between the two bracket arms and secure by means of the two M10 threaded inserts
3. Rotate the speaker to the required position. Using the chain as a safety device equipped with 2 snap hooks and 1 eyebolt (A) to be inserted in the relative anchor point.

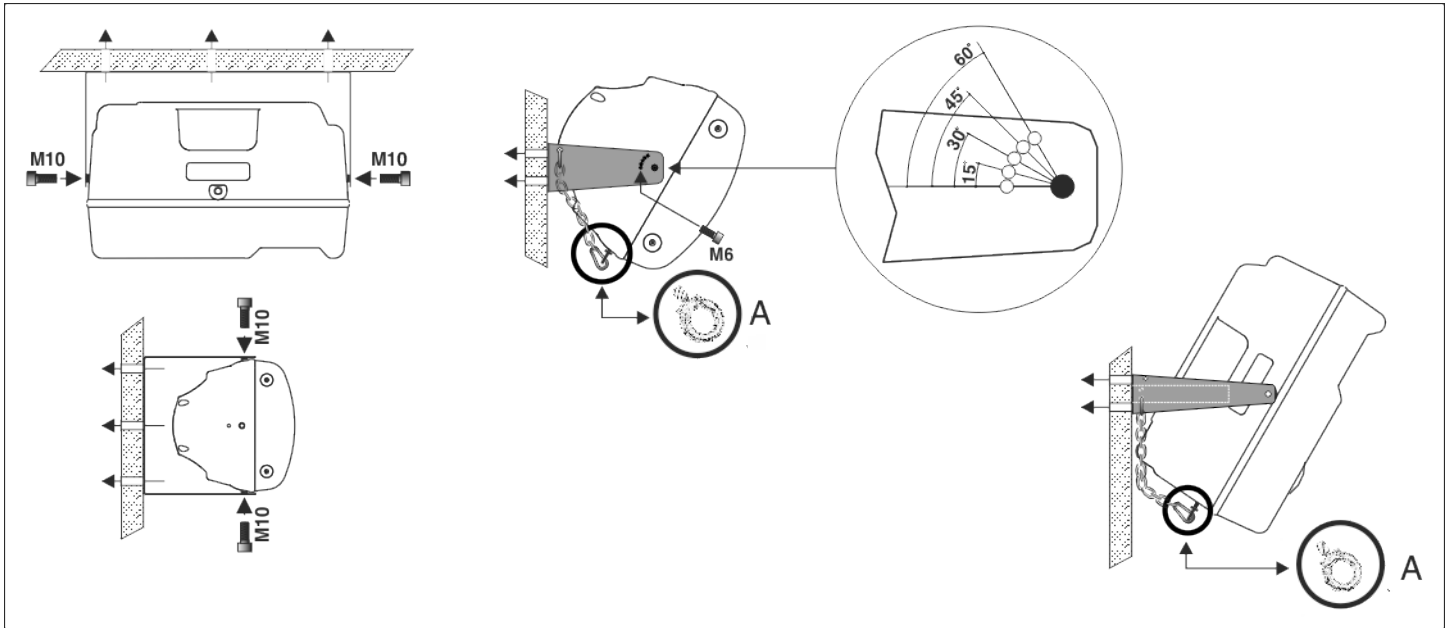

Mod. BOX104 (HORIZONTAL)

1. Take care when selecting the place of speaker installation; ensure the structure is adequate to withstand the weight of the box; fix the base of the bracket to the wall using suitable screws in all bracket fixing holes.
2. Position the speaker between the two bracket arms and secure by means of the two M10 threaded inserts
3. Rotate the speaker to the required position using the M6 threaded insert

Mod. BOX105 (VERTICAL)

1. Take care when selecting the place of speaker installation; ensure the structure is adequate to withstand the weight of the box; fix the base of the bracket to the wall using suitable screws in all bracket fixing holes.
2. Position the speaker between the two bracket arms and secure by means of the two M10 threaded inserts
3. Rotate the speaker to the required position using the M6 threaded insert

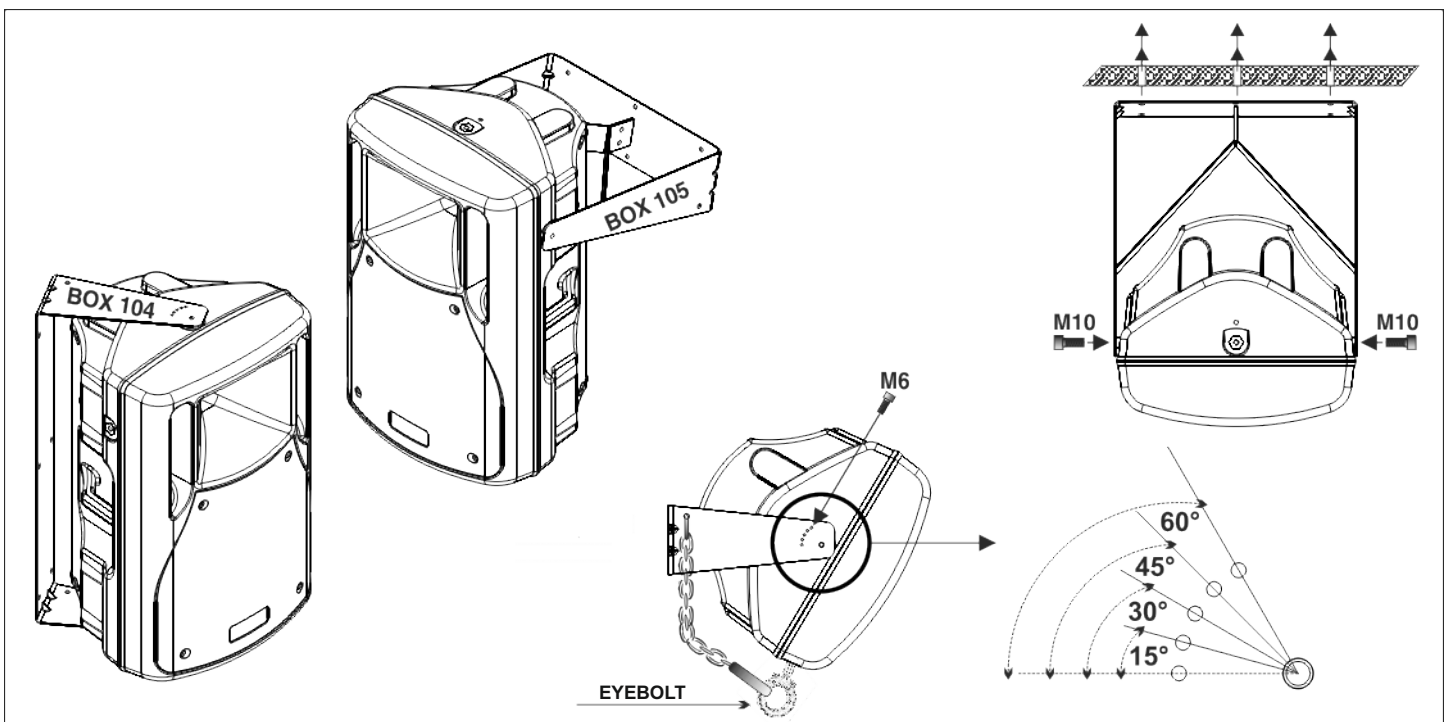

POWER SUPPLY

Before connecting the apparatus to the mains, make sure the supply voltage matches the one indicated on the back of the apparatus. The power socket also includes a fuse box. Faulty fuses shall be replaced only with fuses having the same electrical features and value.

HiMaxX 40 / 40A

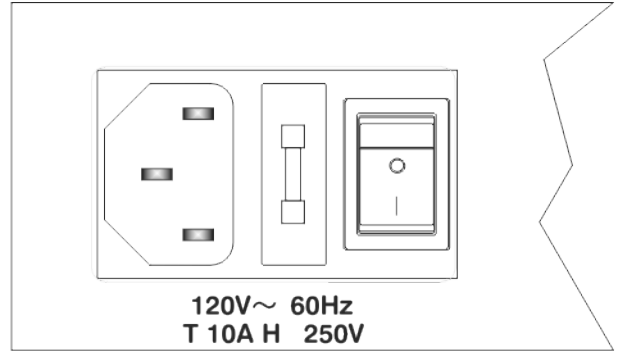
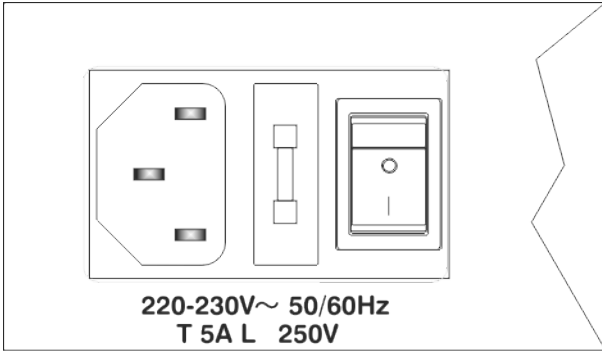

HiMaxX 60 / 60A

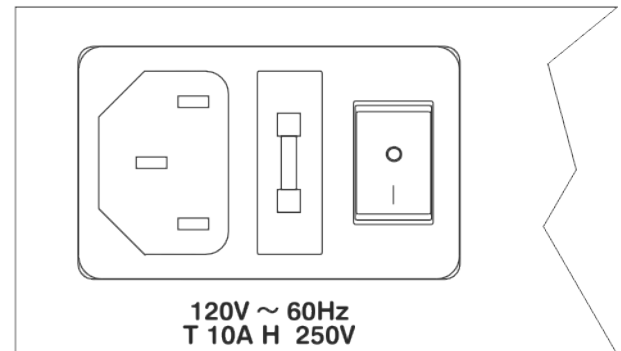
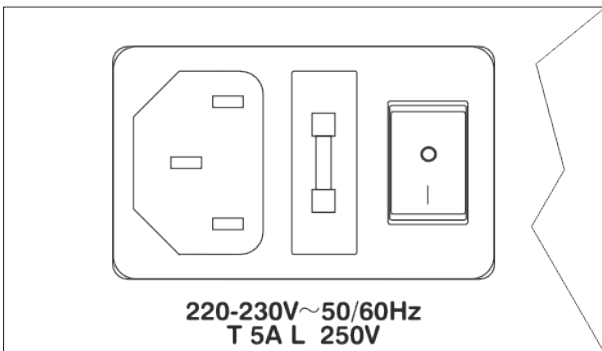

HiMaxX 100SA

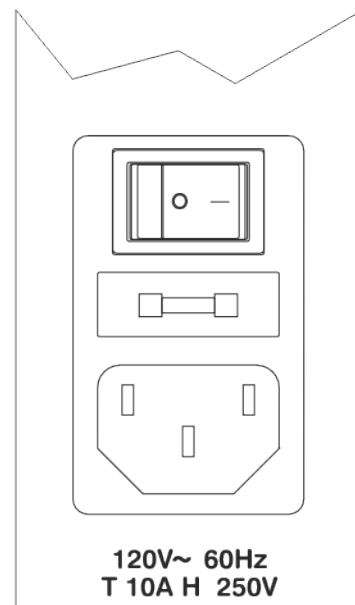
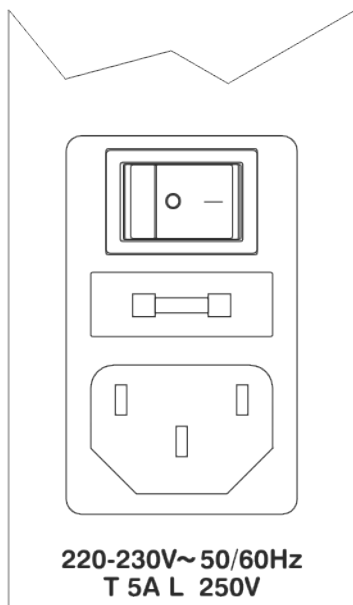

CONTROLS AND FUNCTIONS

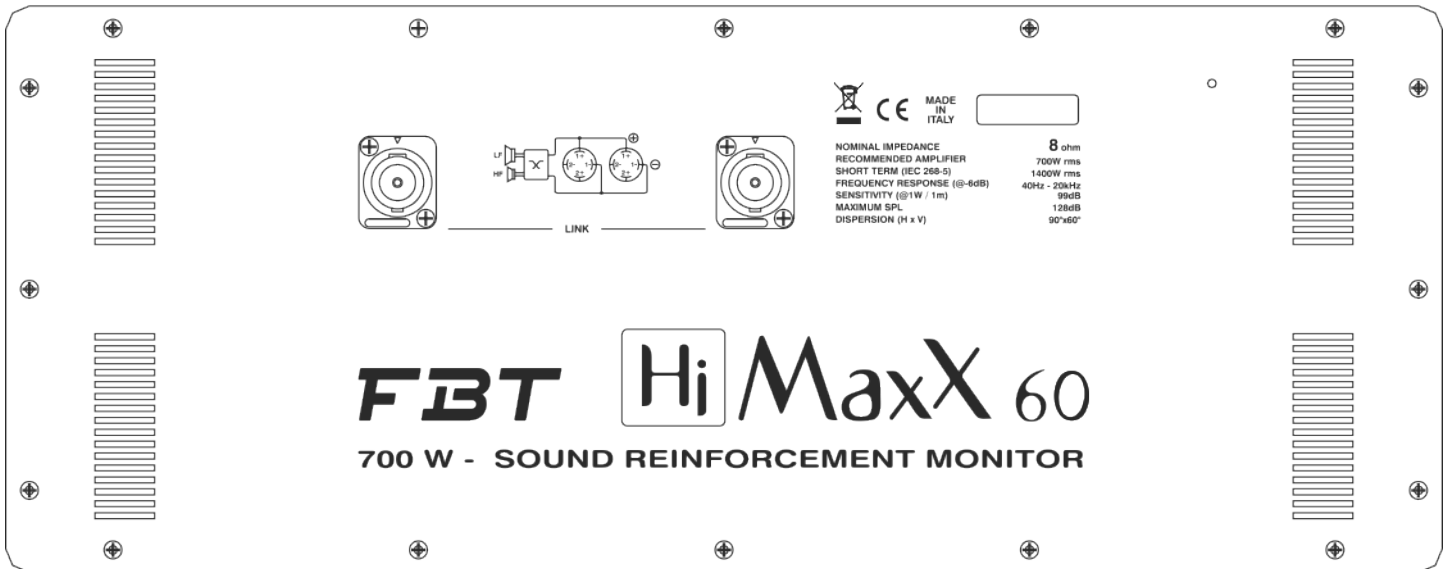
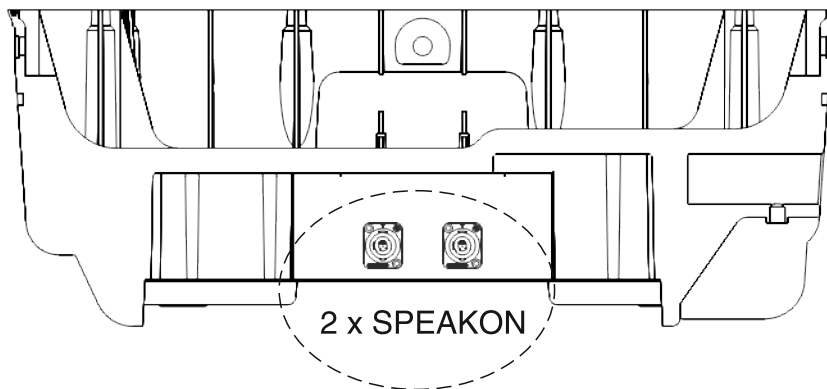
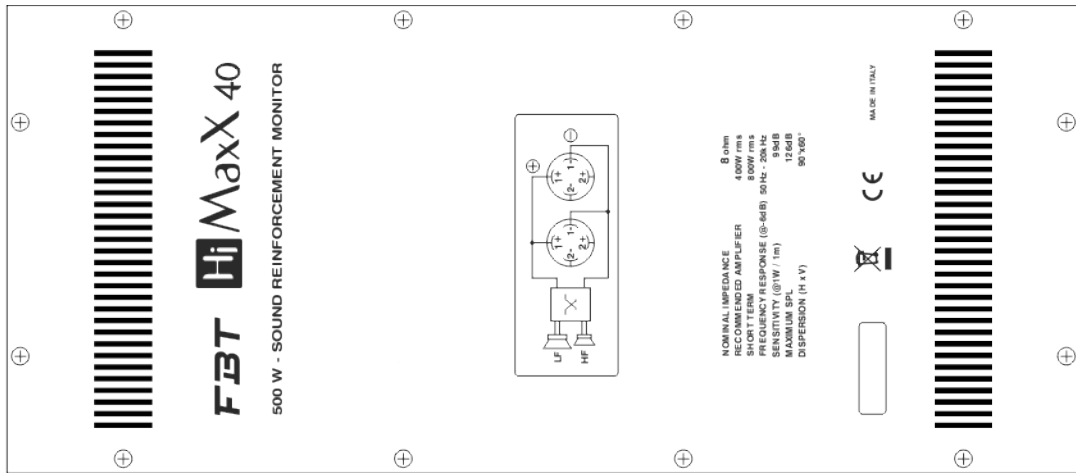

Speakon connectors connected in parallel mode. One connector can be used to connect the box to the output of a power amplifier; the other to connect to a second box.

Loudspeaker cables shall have the adequate diameter, depending on the overall length of the connection. The resistance introduced by an inadequate wiring towards the loudspeakers would reduce both the power output and the damping factor of the loudspeaker.

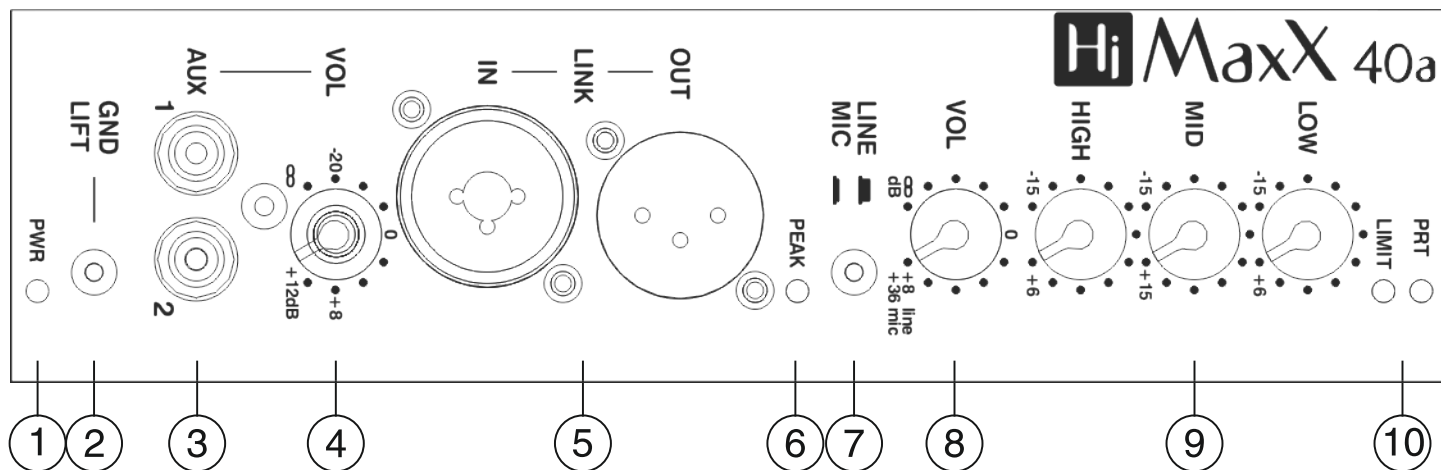

1) PWR: the LED illuminates to indicate that the system is switched on

2) GND LIFT: switch to isolate the chassis ground and the signal ground. With the switch held down, the input signal ground is electrically disconnected from the chassis ground (identified in the chassis); in the case where speaker hum should occur, this allows for the opening of “ground loops” which are often the cause of these problems. ONLY USE THE GROUND LIFT FOR BALANCED SIGNALS.

3) AUX 1/2: RCA socket for connecting with external signal sources (CD, tape recorder, dat, iPod, etc); channels 1 and 2 are added together and are sent to the relative volume control (4).

5) IN link OUT: electronically-balanced input and output connectors; the “IN” XLR-jack combo enables the connection of a microphone or a preamplified signal such as a mixer output; the “OUT” XLR is connected in parallel (link) with the “IN” input and enables the same signal to be relayed to several speakers.

6) PEAK: the LED illuminates to indicate the signal level is close to saturation; should this occur when a microphone source is connected, turn down the “HiMaxX” volume control; if a signal source with its own volume controls is connected (mixer, etc), turn down the volume of the signal using these controls.

7) LINE/MIC: position the switch to “MIC” if a microphone is connected; position to “LINE” when connecting a high level signal source.

8) VOL: regulates the general signal level. This control has priority over the AUX volume control. Also acts as a gain control so as to optimise the signal/noise relationship and the dynamic range of the pre-amp.

9) HIGH/MID/LOW: controls which allow the modification of the tone of the sound.

10) LIMIT/PRT: the LED illuminates when the system is being used at the limits of the average power tolerance of the loudspeakers; the signal is then gradually reduced until it is within the safety limits of the loudspeaker: it is advised to operate the system so that this LED illuminates only occasionally; the PRT LED illuminates when the internal temperature of the amplifier reaches the maximum limit: the signal is then automatically gradually reduced, until the temperature is once again within safety limits. The illumination of this LED may indicate a malfunction of the amplifier caused by a short circuit.

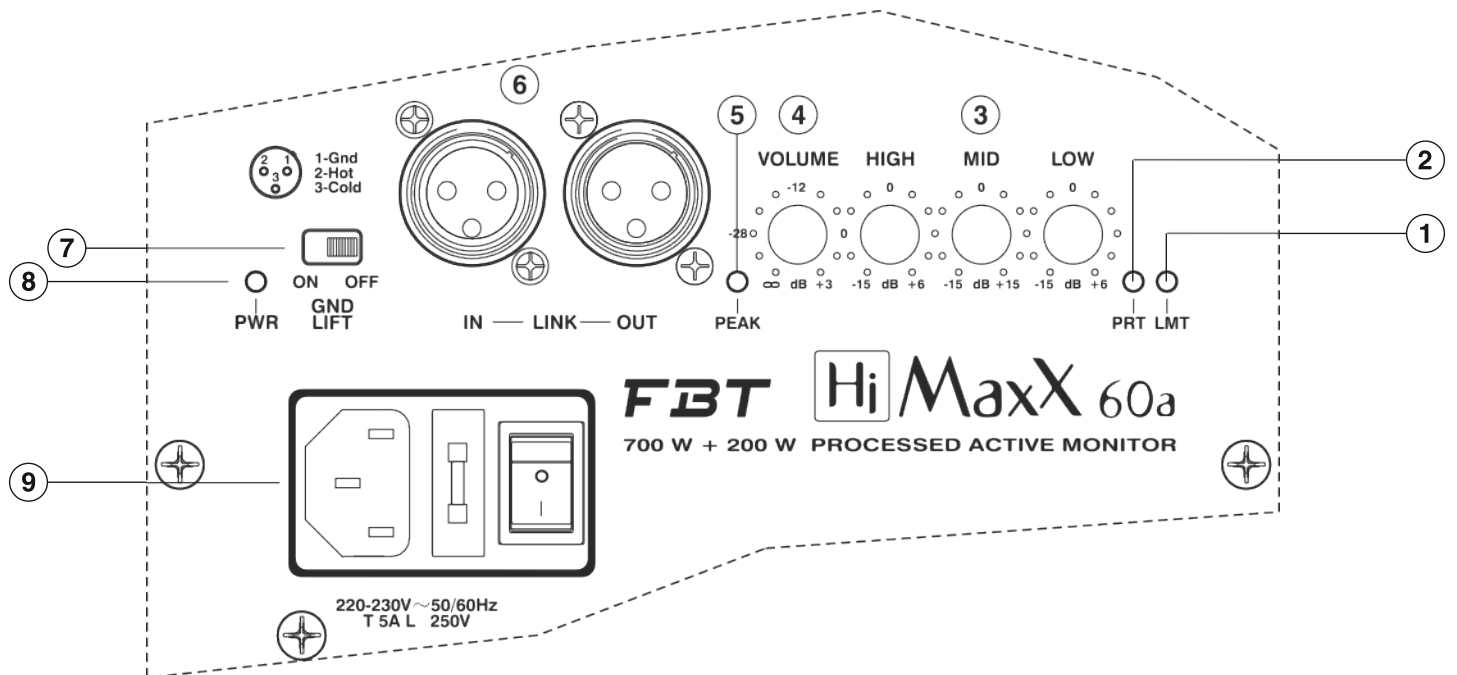

1) LIMITER: the LED illuminates when the system is being used at the limits of the average power tolerance of the loudspeakers; the signal is then gradually reduced until it is within the safety limits of the loudspeaker: it is advised to operate the system so that this LED illuminates only occasionally.

2) PRT: the PRT LED illuminates when the internal temperature of the amplifier reaches the maximum limit: the signal is then automatically gradually reduced, until the temperature is once again within safety limits. The illumination of this LED may indicate a malfunction of the amplifier caused by a short circuit.

3) HIGH/MID/LOW: controls which allow the modification of the tone of the sound.

4) VOL: regulates the general signal level.

5) PEAK: the LED illuminates to indicate the signal level is close to saturation; if a signal source having its own volume controls (mixer, etc.) is connected, use such controls to lower the volume of the signal and, then, use HiMaxX volume control.

6) IN link OUT: electronically-balanced input and output connectors; the "IN" XLR-jack combo enables the connection of a preamplified signal such as a mixer output; the "OUT" XLR is connected in parallel (link) with the "IN" input and enables the same signal to be relayed to several speakers.

7) GND LIFT: switch to isolate the chassis ground and the signal ground. With the switch held down, the input signal ground is electrically disconnected from the chassis ground (identified in the chassis); in the case where speaker hum should occur, this allows for the opening of "ground loops" which are often the cause of these problems. **ONLY USE THE GROUND LIFT FOR BALANCED SIGNALS.**

8) PWR: the LED illuminates to indicate that the system is switched on

9) POWER SOCKET: includes the system "power on" switch, the socket for connection to the power supply and the housing of the circuit breaker.

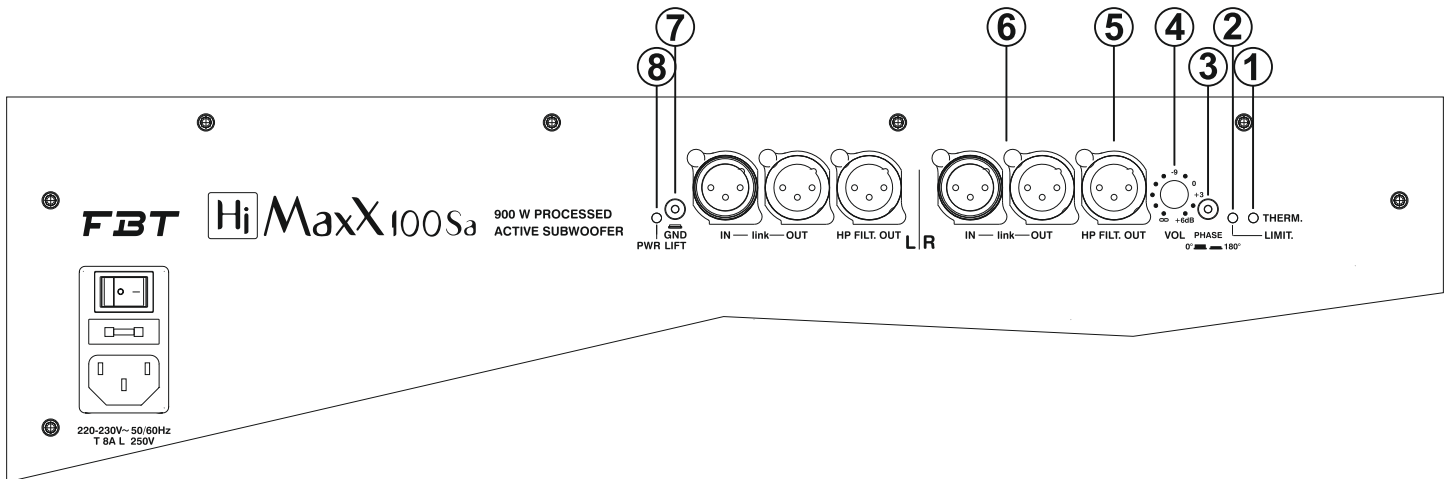

1) THERMAL: The THERM LED illuminates when the internal temperature of the amplifier reaches the maximum limit: the signal is then automatically gradually reduced, until the temperature is once again within safety limits.

2) LIMITER: The LED illuminates when the system is being used at the limits of the average power tolerance of the loudspeakers; the signal is then gradually reduced until it is within the safety limits of the loudspeaker: **it is advised to operate the system so that this LED illuminates only occasionally.**

3) PHASE: Switch which allows for the optimisation of phase alignment - that is, to obtain a uniform frequency response in the crossover zone between sub and satellite.

When it is set at 0°, the sound emission is in phase with the input signal; when it is set at 180° the sound emission is in counterphase with the input signal. Thanks to this control subwoofer adjustment will be even more flexible, thus improving its performance.

4) VOL: Volume control which regulates the general level of the signal

5) HP FILTERED OUT: Output for taking the filtered signal and sending it to an amplified satellite; this avoids having the two connected speakers operate within the same frequency interval, and thus obtains a complex response without interference.

6) IN link OUT: Electronically-balanced input and output connectors; the "IN" socket is for the connection of balanced or unbalanced preamplified signals (such as a mixer output); the "OUT" socket can be used for connecting in parallel with other subwoofers (connection with a satellite can only then be made using the "HP FILT. OUT" socket)

7) GND LIFT: switch to isolate the chassis ground and the signal ground. With the switch held down, the input signal ground is electrically disconnected from the chassis ground (identified in the chassis); in the case where speaker hum should occur, this allows for the opening of "ground loops" which are often the cause of these problems. **ONLY USE THE GROUND LIFT FOR BALANCED SIGNALS.**

8) PWR: the LED illuminates to indicate that the system is switched on

9) POWER SOCKET: includes the system "power on" switch, the socket for connection to the power supply and the housing of the circuit breaker.

CONNECTION EXAMPLES

Hi MaxX 40a

Hi MaxX 40a

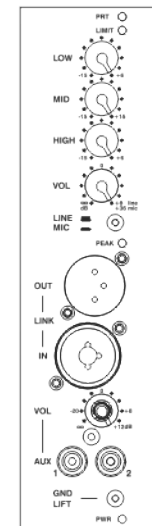
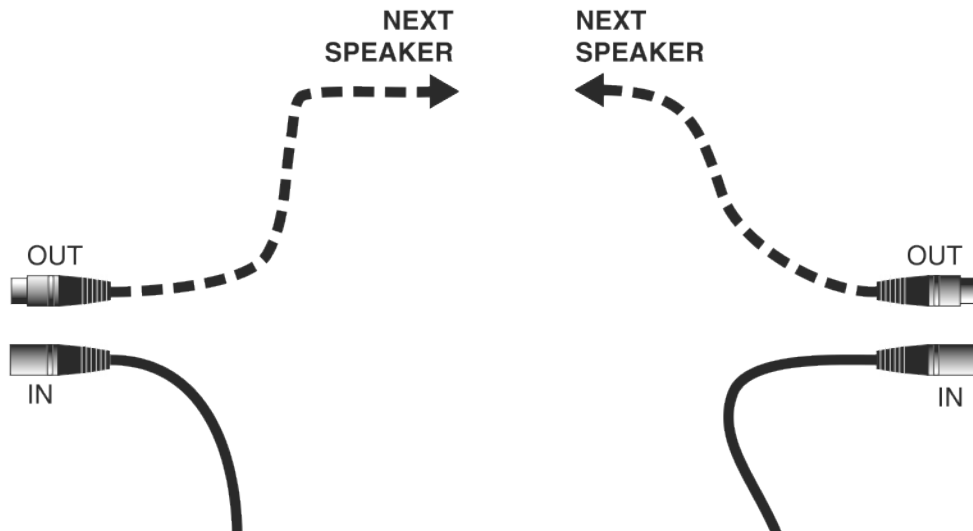
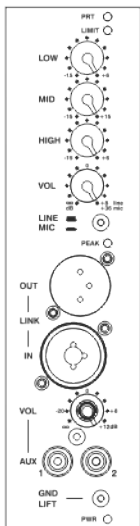
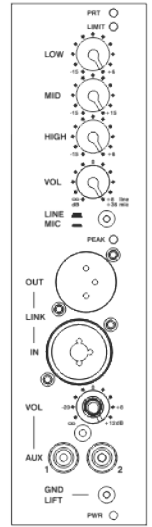
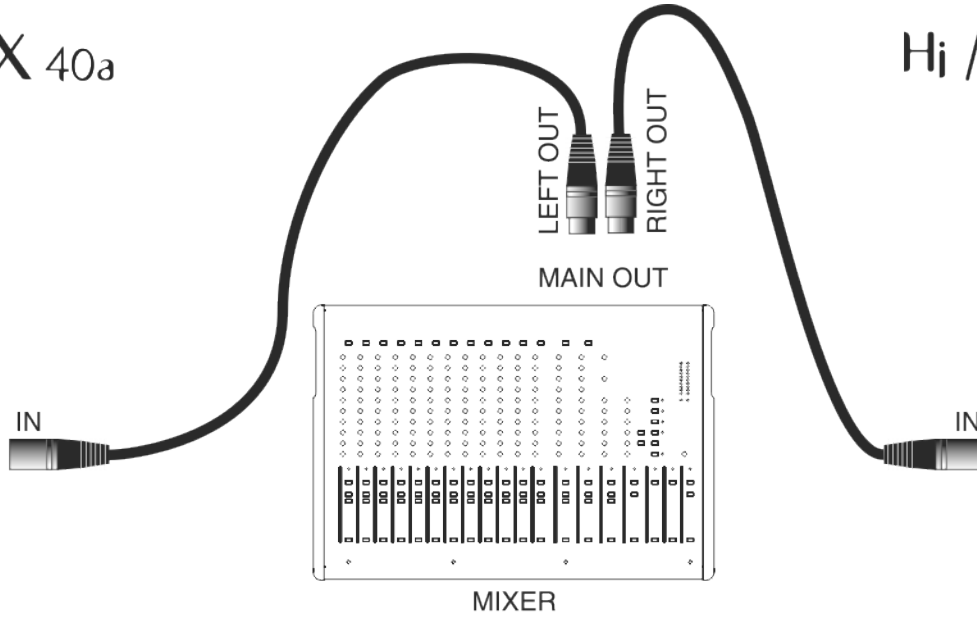
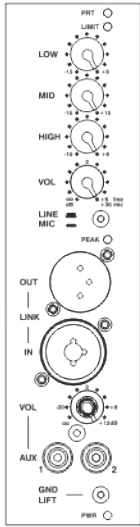

Hi MaxX 40a

Hi MaxX 40a

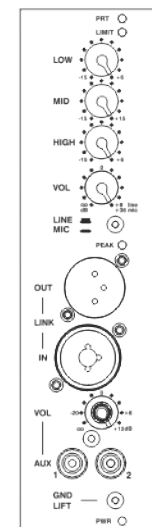
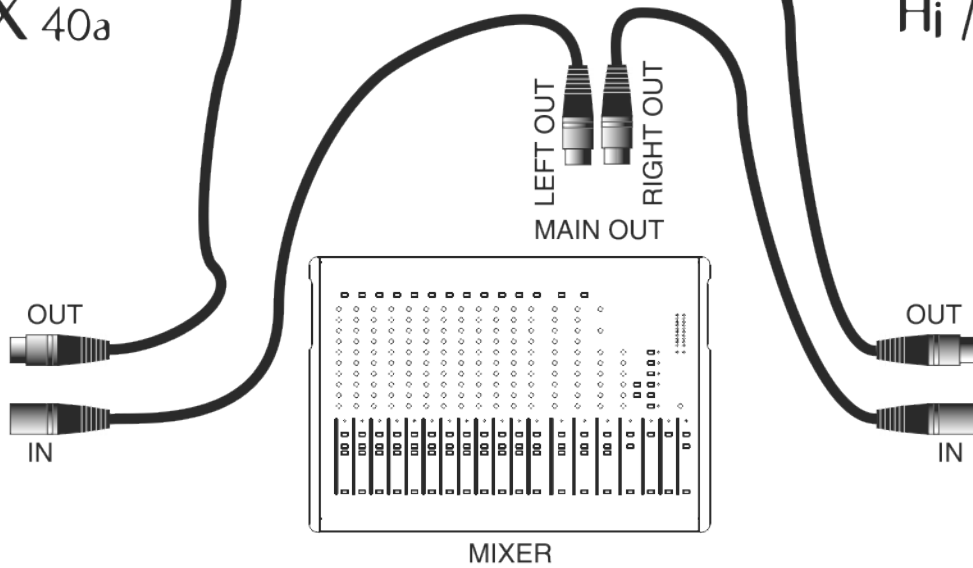
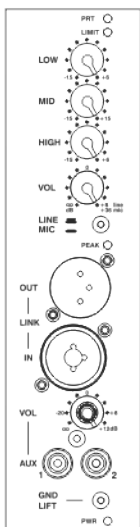

CONNECTION EXAMPLES

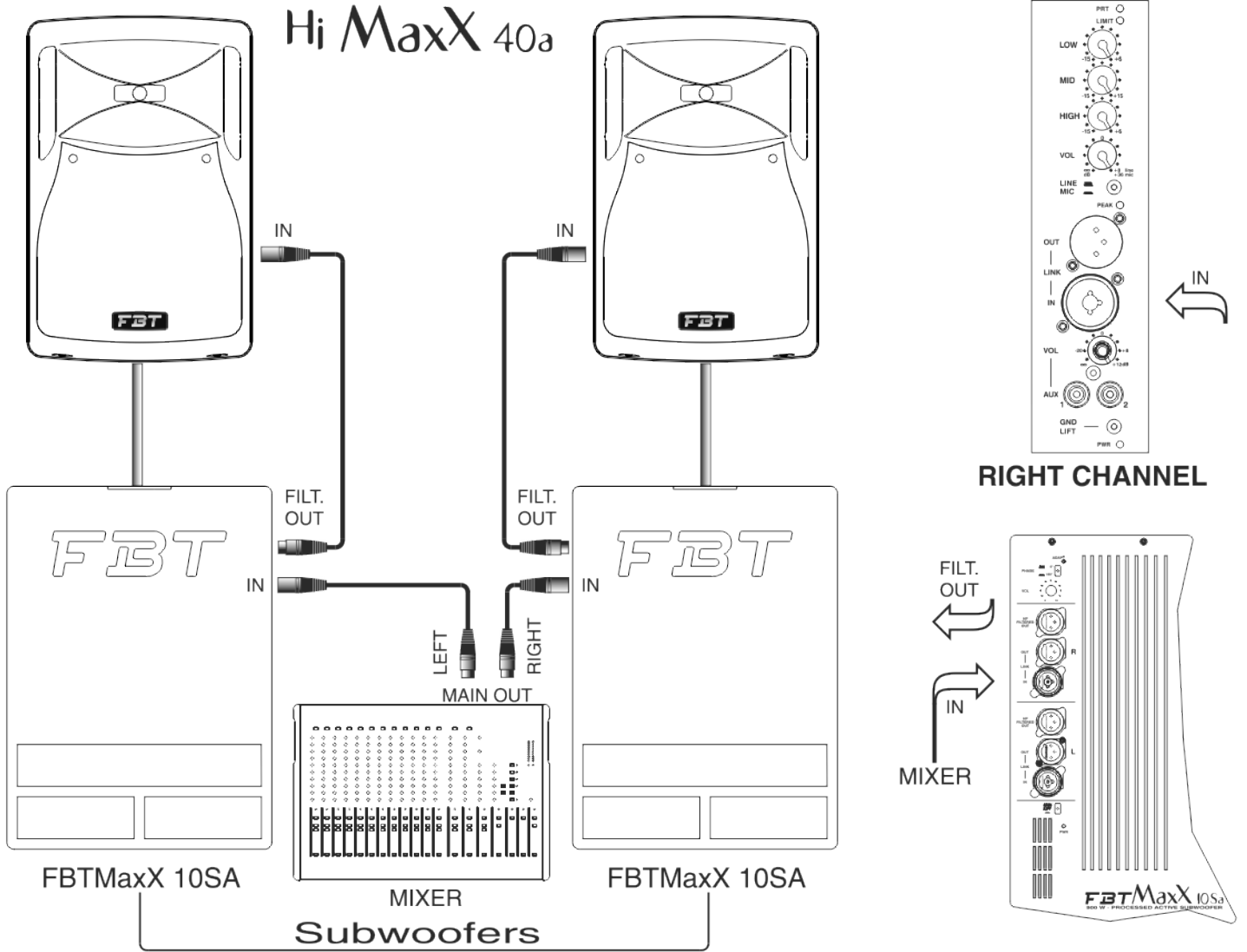

Hi MaxX 40a

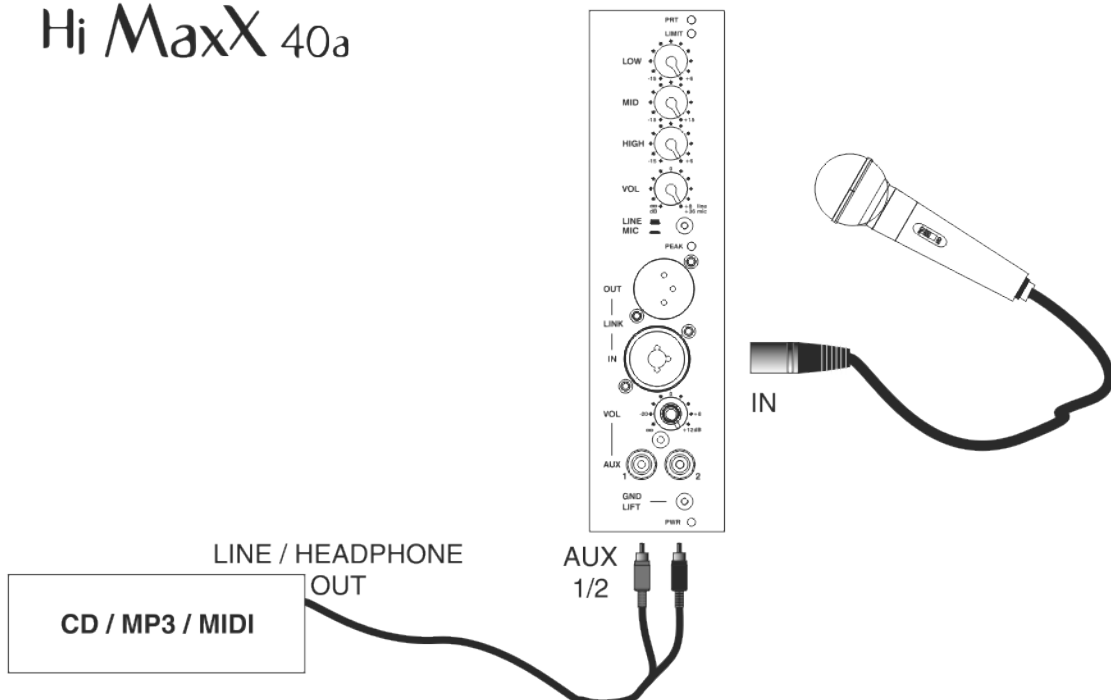

CONNECTION EXAMPLES

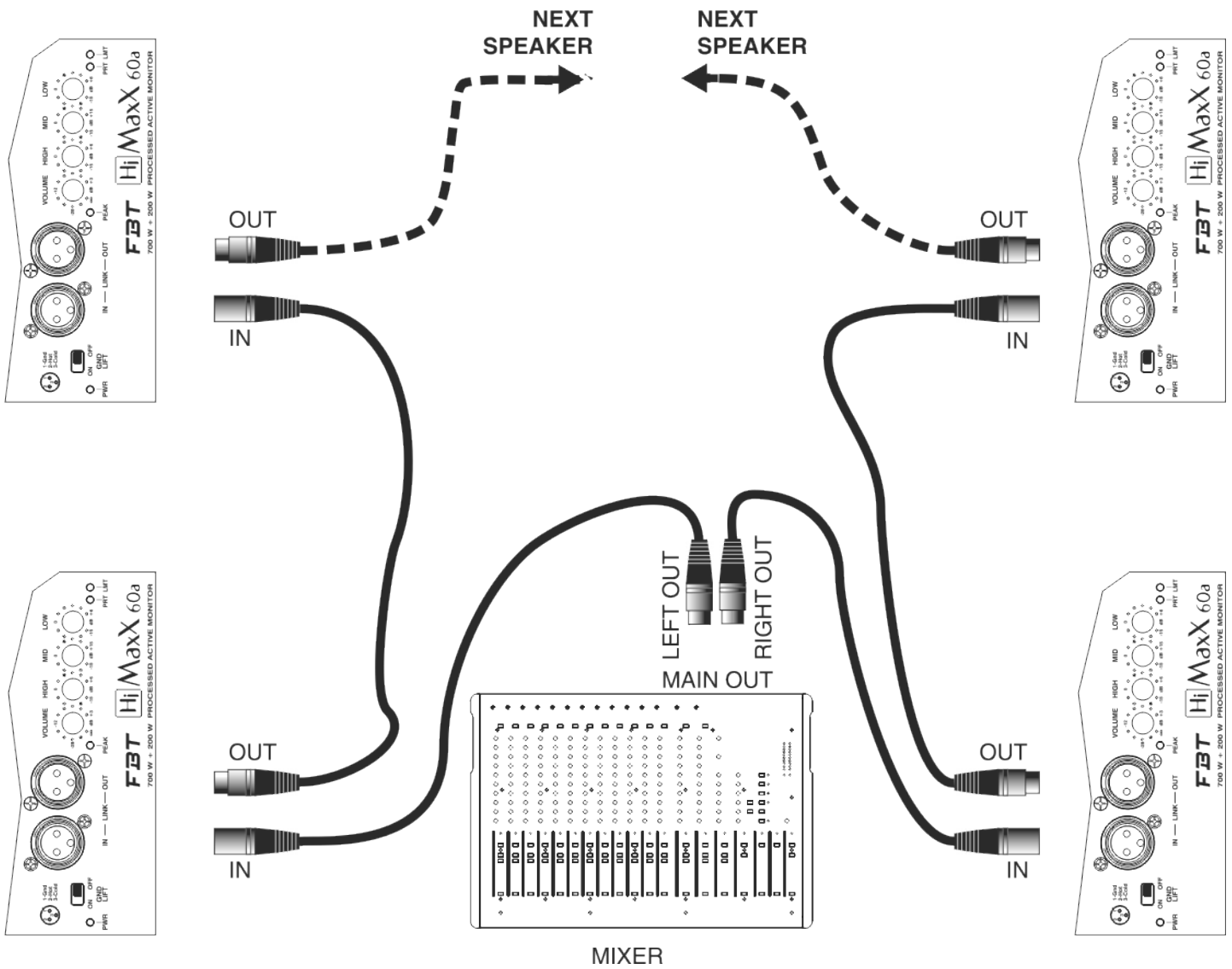
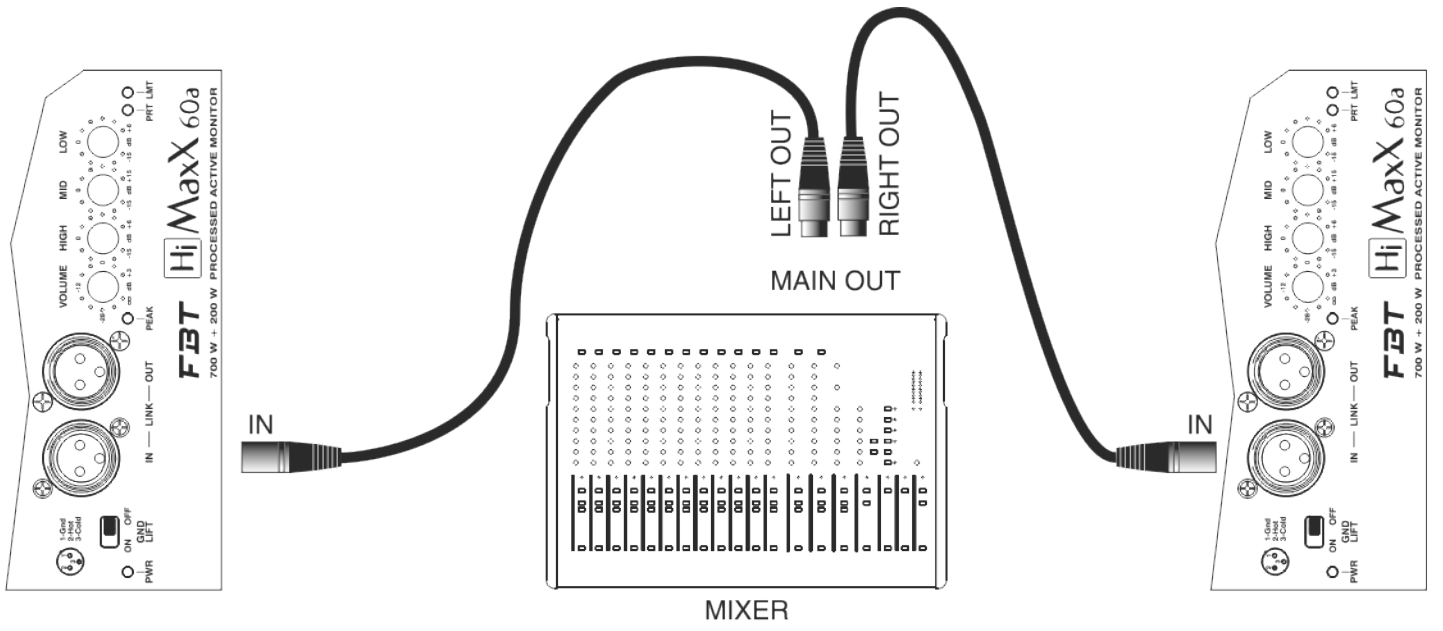

CONNECTION EXAMPLES

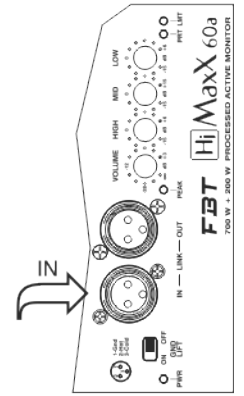
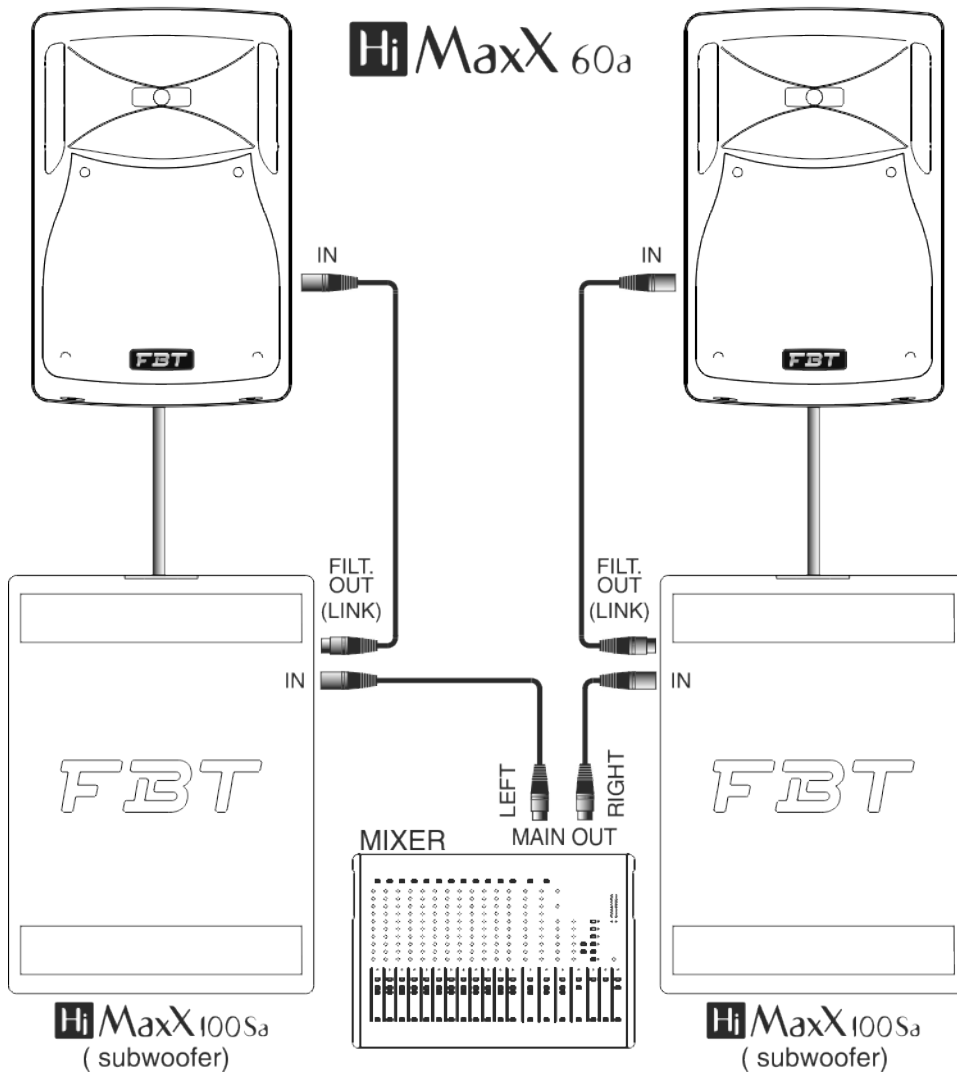

(RIGHT CHANNEL)

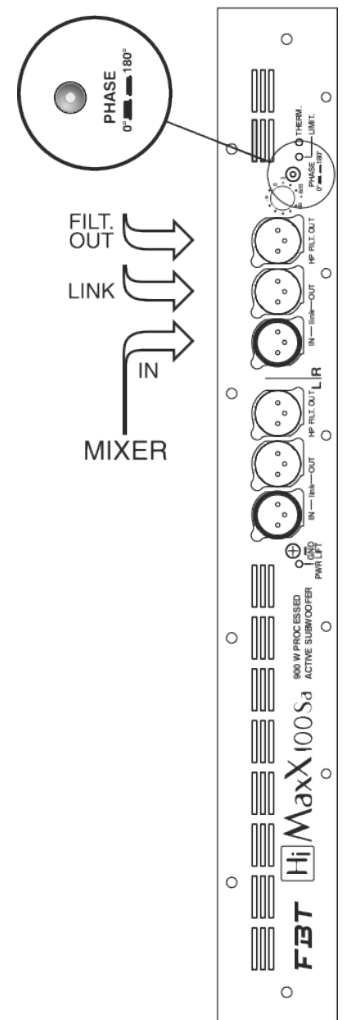

The sub **HiMaxX 100SA** and the satellite can be connected in two different ways: using either the **FILTERED OUT** output or the **LINK** socket of the Sub.

If the **FILTERED OUT** output is used, only the Sub reproduces the low frequencies and the maximum sound quality is achieved; in this case, set the **PHASE** switch at **180°**.

If the **LINK** output is used, the maximum **SPL** (Sound Pressure Level) is achieved for the low frequencies, that are reproduced by the satellite and the sub; in this case, set the **PHASE** switch at **0°**.

For any sub/satellite configuration, always use the **PHASE** control to achieve the maximum **SPL** at low frequencies.

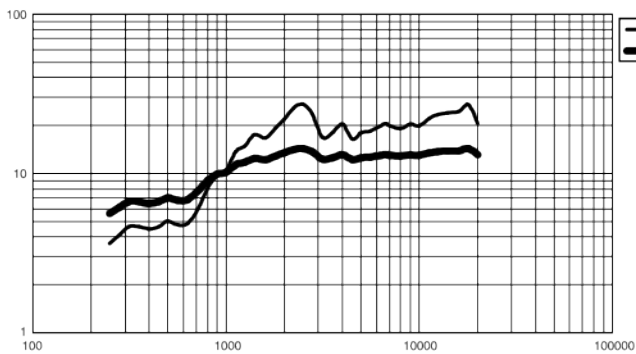
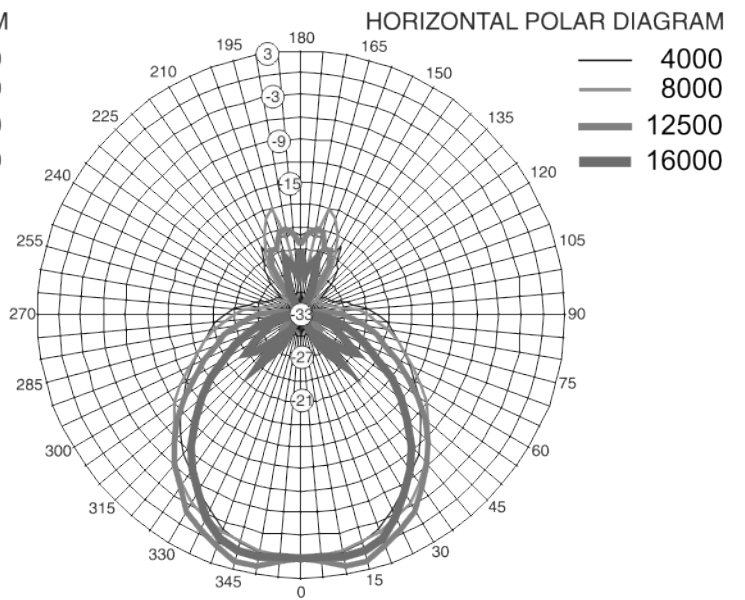
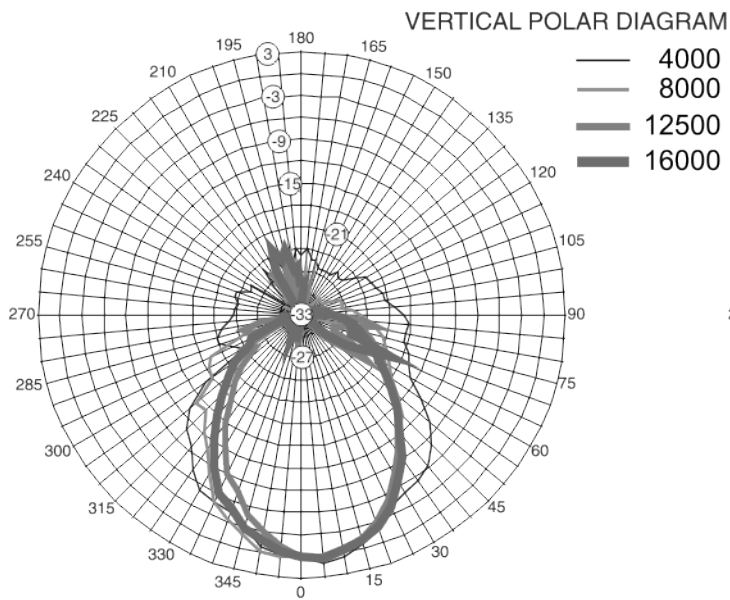
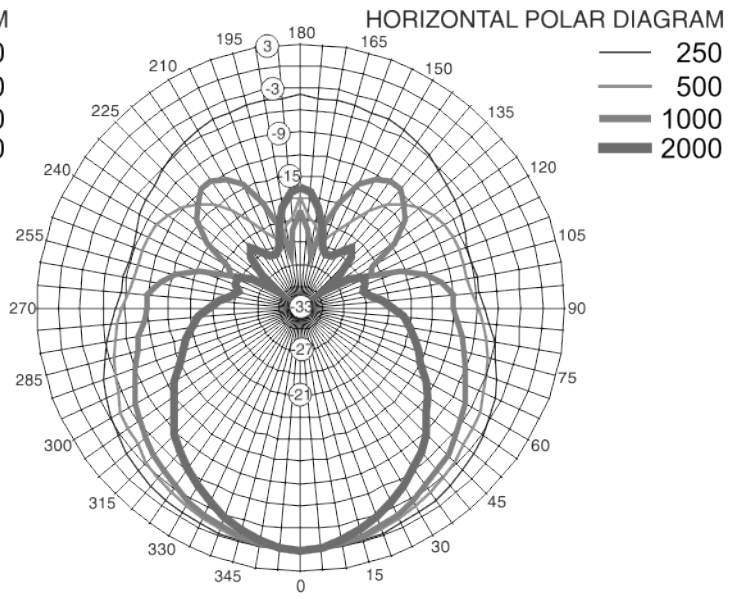
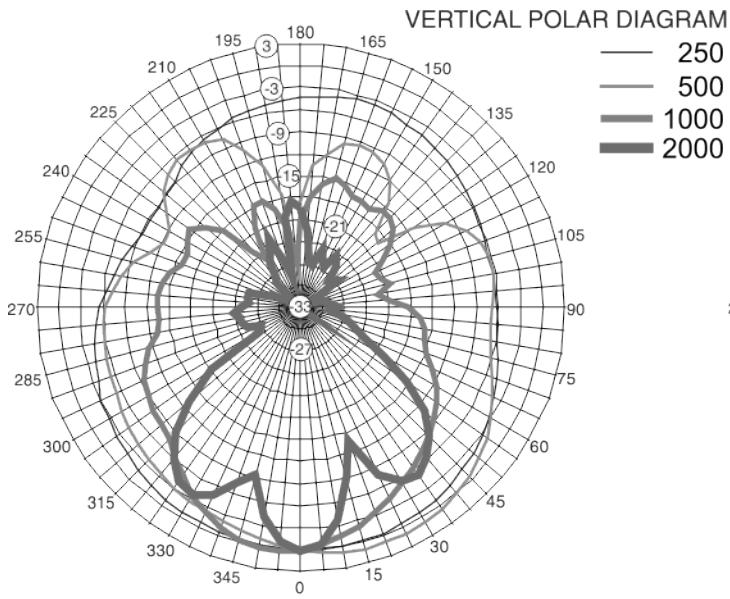

Q FACTOR & DIRECTIVITY INDEX (DI)

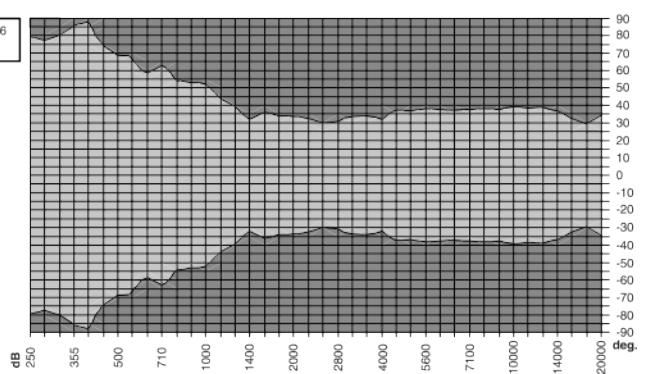

HORIZONTAL COVERAGE

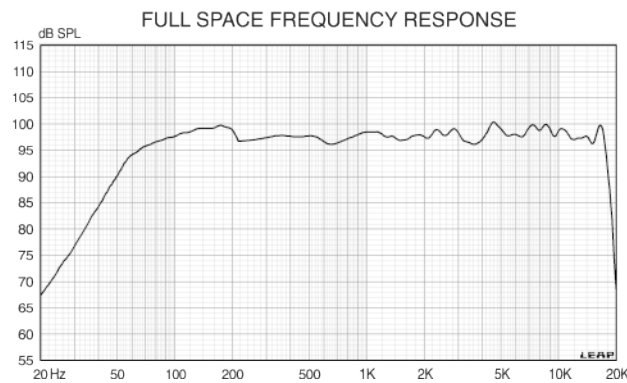

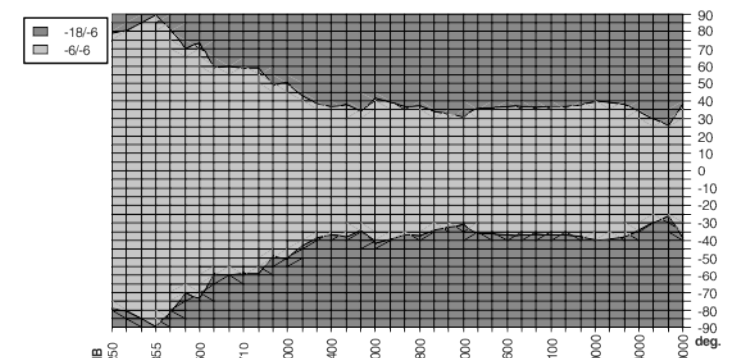
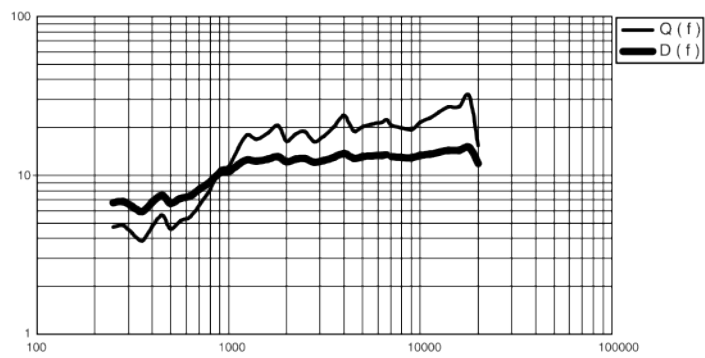
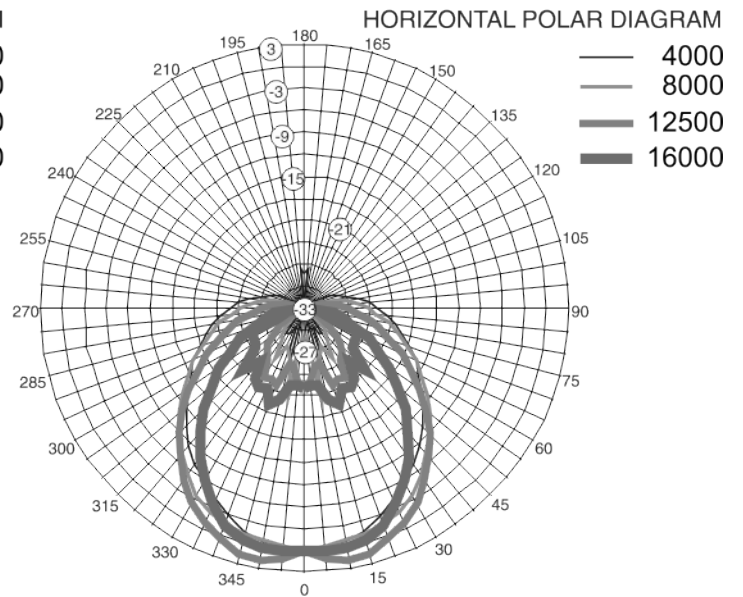
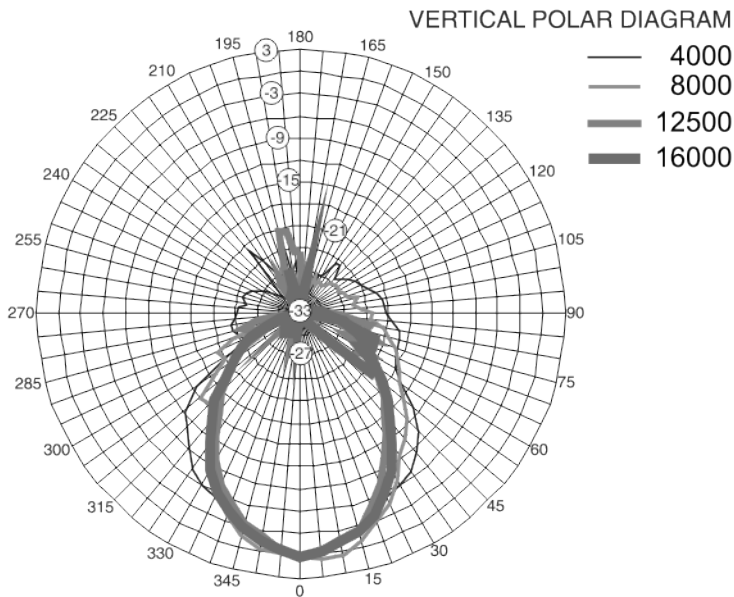
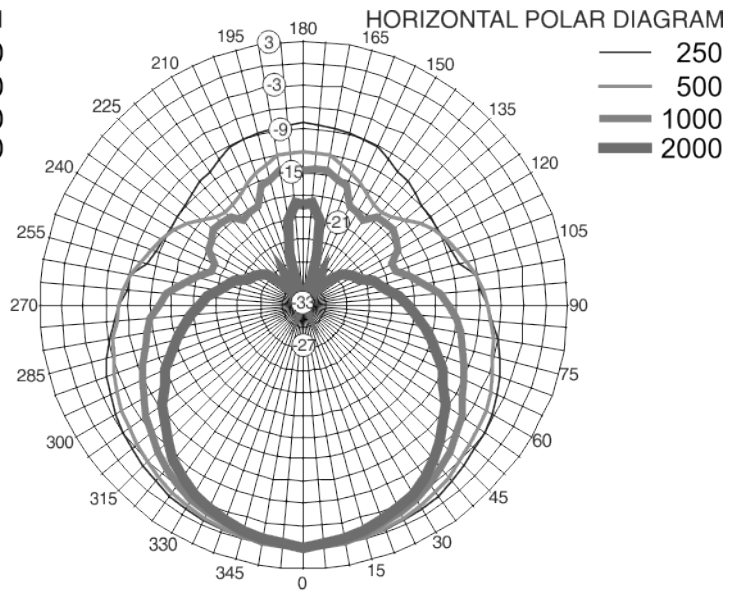
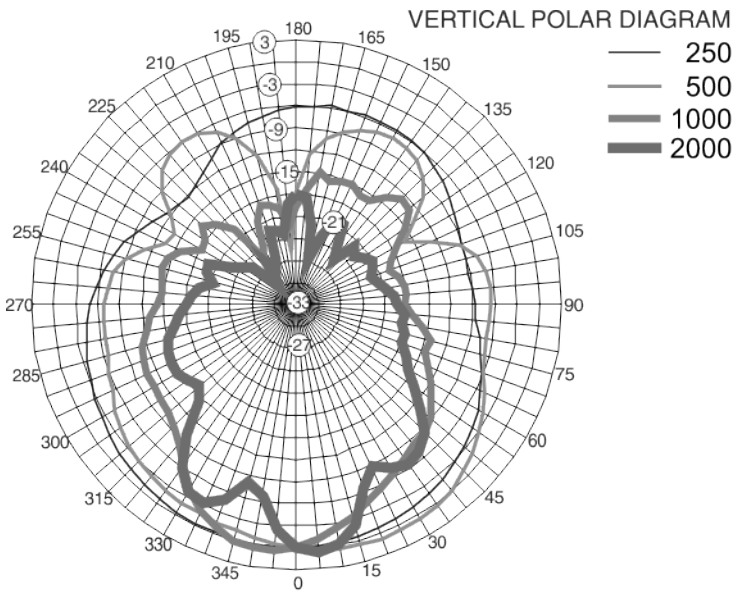

Q FACTOR & DIRECTIVITY INDEX (DI)

FULL SPACE FREQUENCY RESPONSE

HORIZONTAL COVERAGE

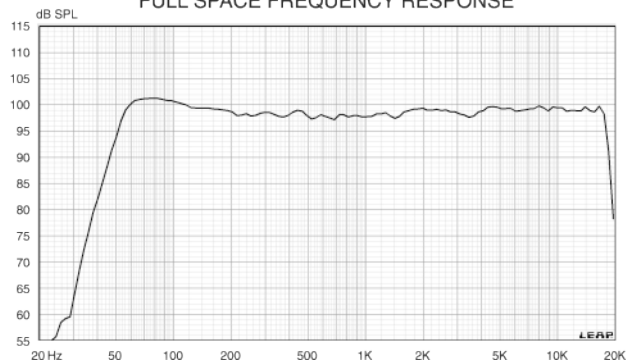

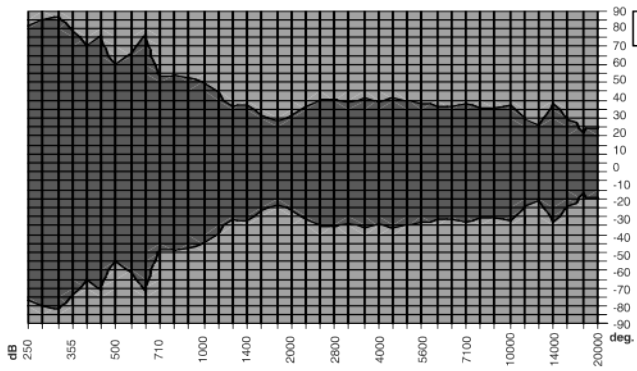
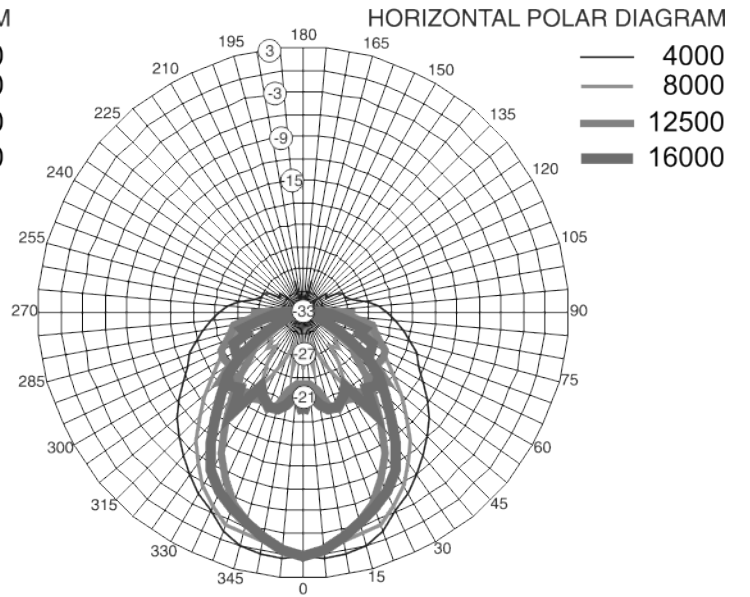
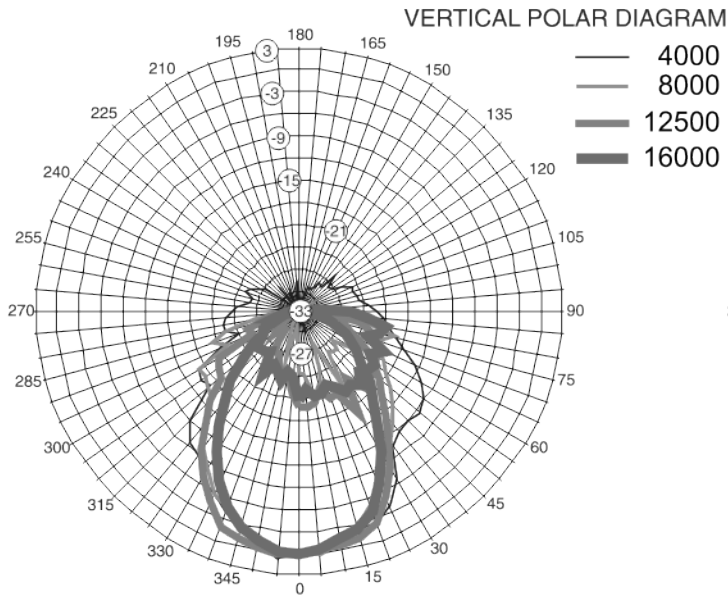
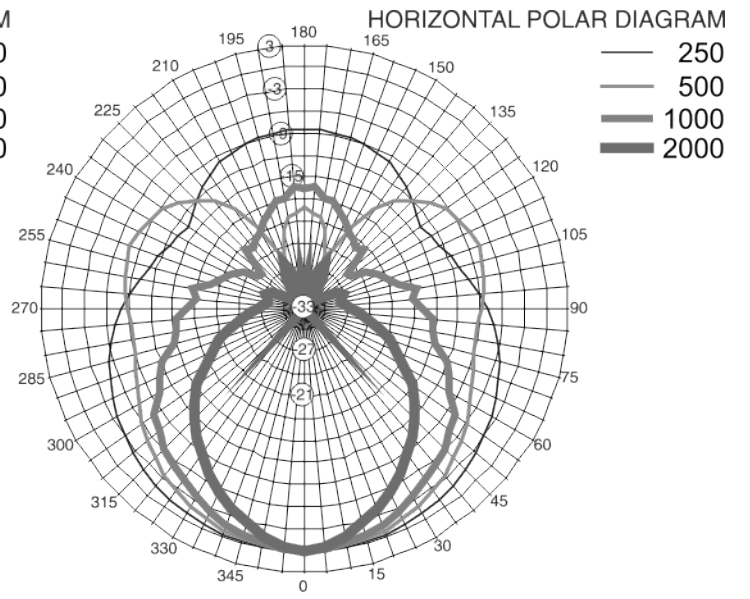
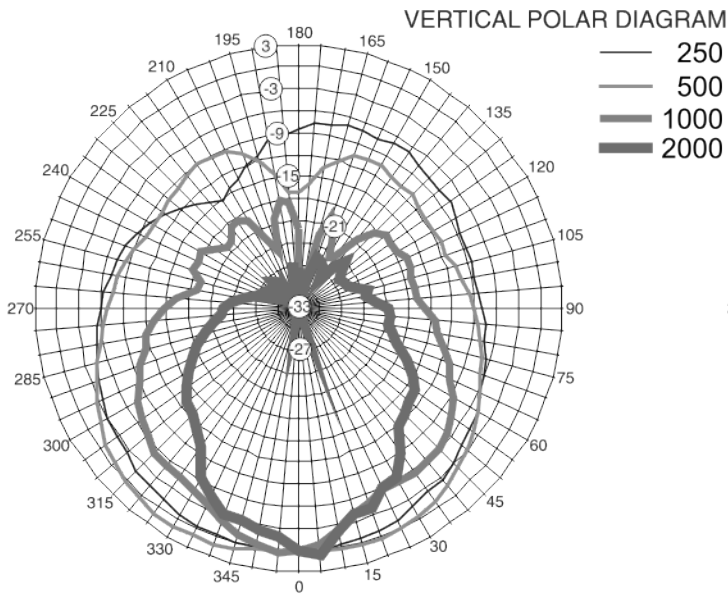

HORIZONTAL COVERAGE

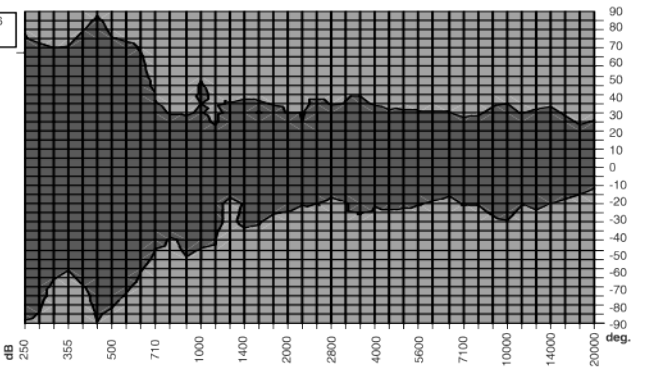

VERTICAL COVERAGE

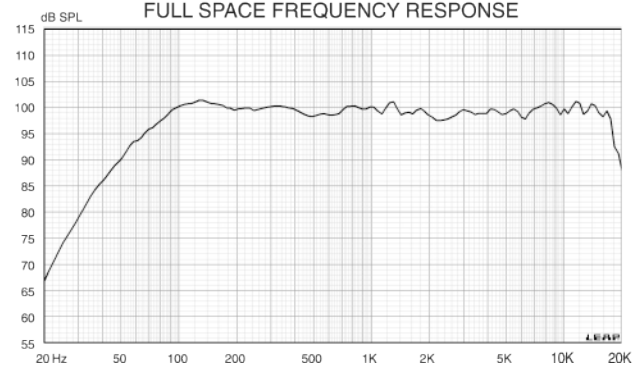

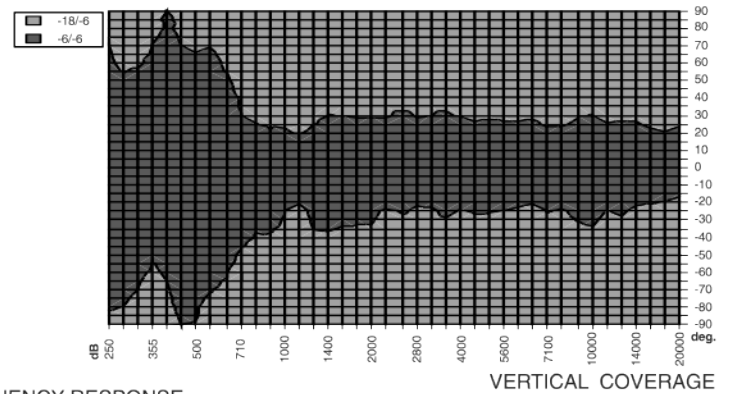
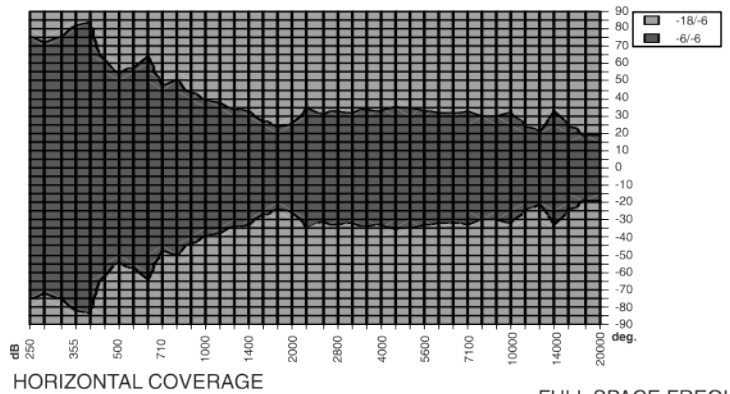
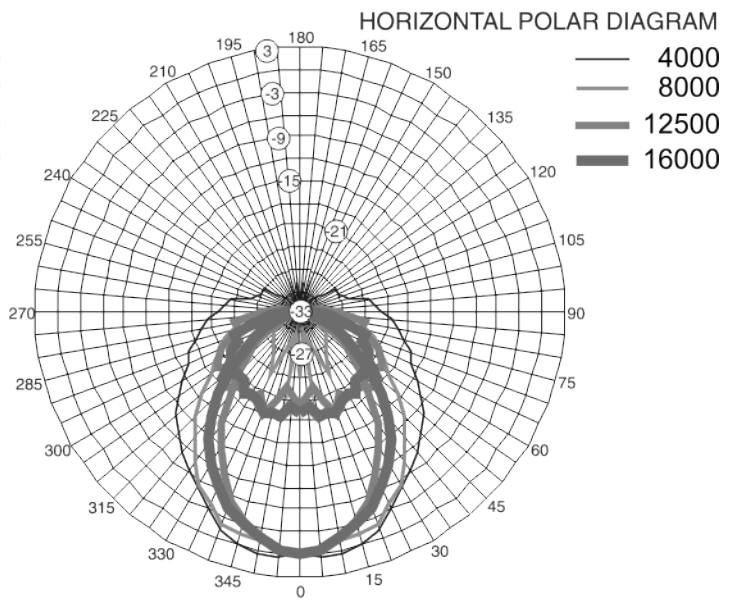
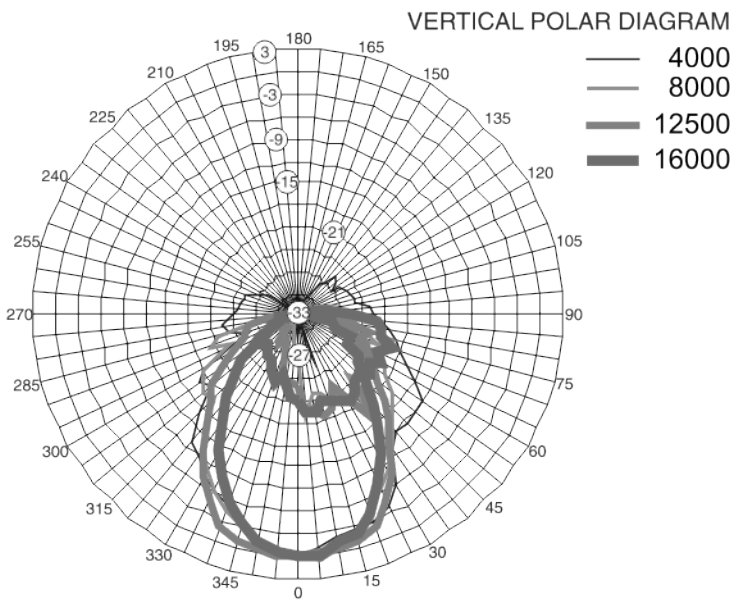
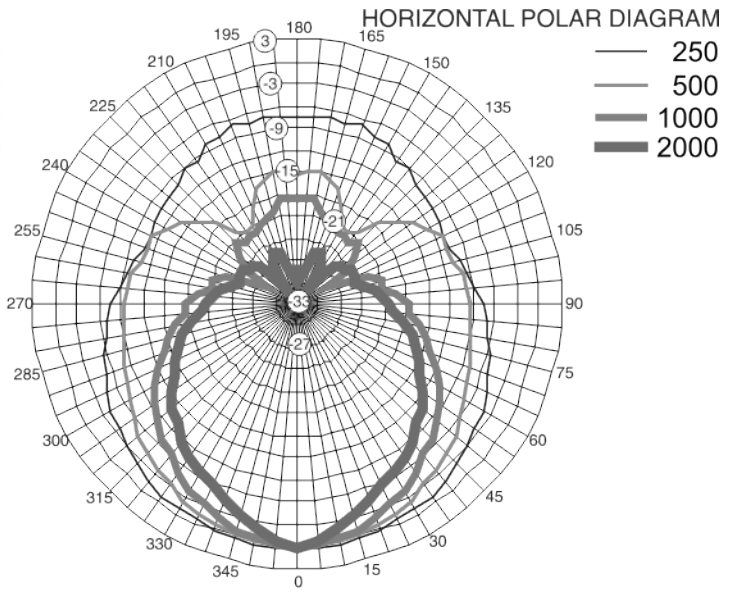
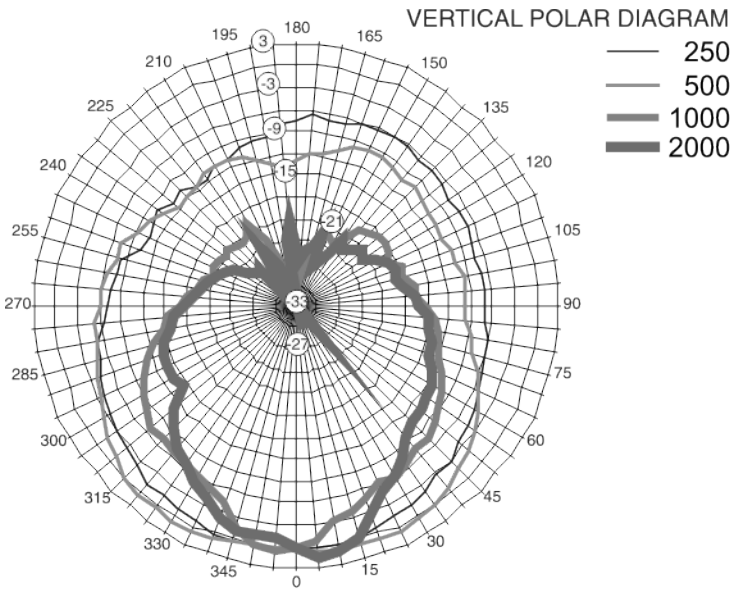

HORIZONTAL COVERAGE

VERTICAL COVERAGE

FULL SPACE FREQUENCY RESPONSE

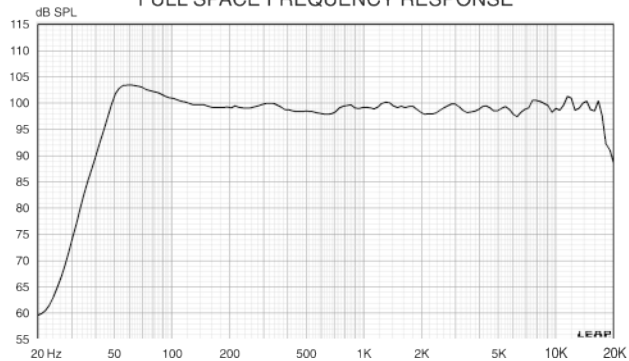

FREQUENCY RESPONSE

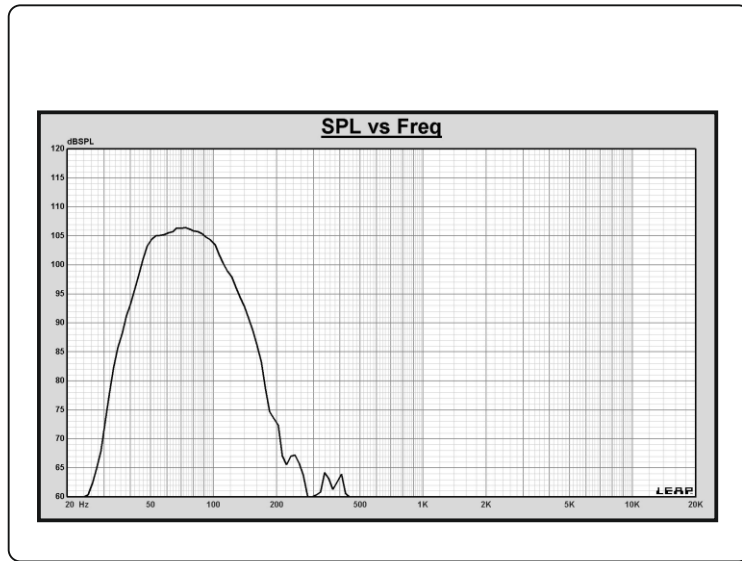

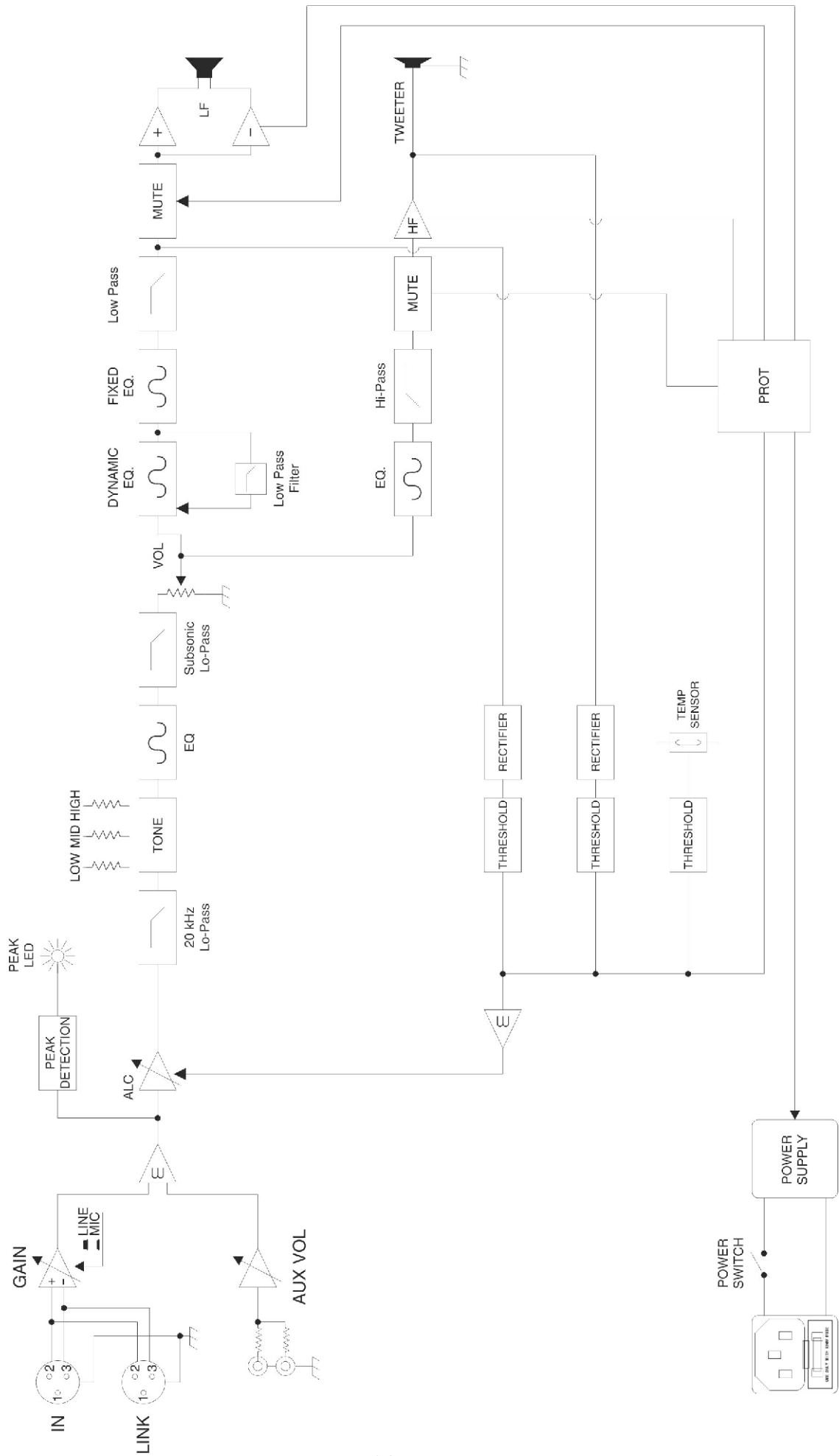

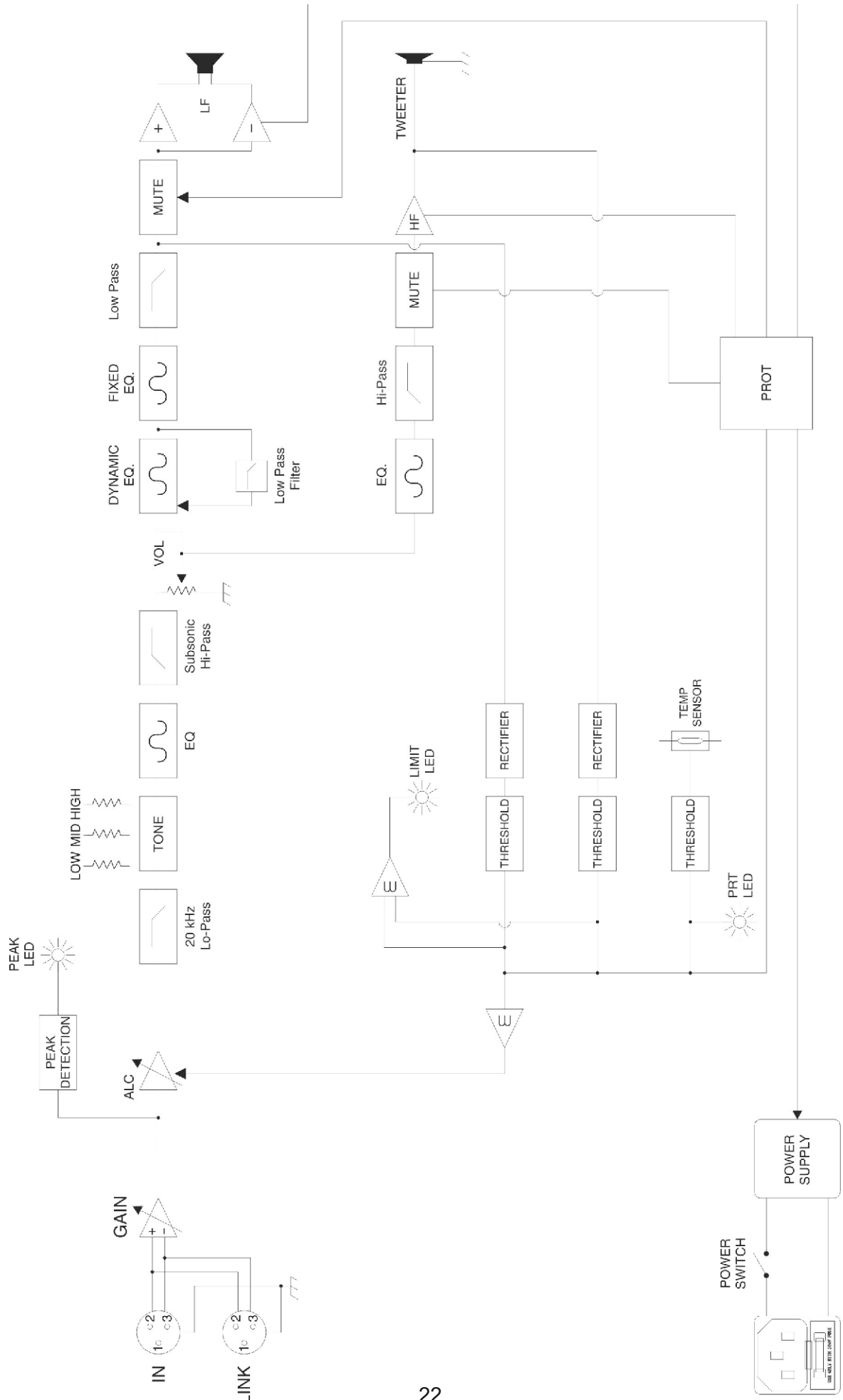

TECHNICAL SPECIFICATIONS

		Hi MaxX 40a	Hi MaxX 40
Type	Way	2	2
Nominal impedance	Ohm	•	8
Recommended amplifier	W rms	•	500
Built-in amplifier	W rms	500 + 150	•
Frequency response	@ -5dB	45Hz - 20kHz	50Hz - 20kHz
Short term (IEC268-5)	W rms	•	1000
Sensitivity @ 1W / 1 m	dB	99	99
Maximum SPL	dB	127	127
High frequency driver	inch	1 x 25.4	1 x 25.4
Low frequency woofer	inch	1 x 12"	1 x 12"
Dimensions (WxHxD)	inch	16 x 25 x 14.5	16 x 25 x 14.5
Weight	Lb.	39.46	35.27
Input connectors		XLR / RCA	2 x speakon

		Hi MaxX 60a	Hi MaxX 60
Configurazione	Way	2	2
Impedenza nominale	Ohm	•	8
Amplificatore raccomandato	W rms	•	700
Amplificatore interno	W rms	700 + 200	•
Risposta in frequenza	@ -5dB	40Hz - 20kHz	40Hz - 20kHz
Short term (IEC268-5)	W rms	•	1400
Sensibilità @ 1W / 1 m	dB	99	99
Massimo SPL	dB	129	128
Unità alte frequenze	inch	1 x 1,4"	1 x 1,4"
Unità basse frequenze	inch	1 x 15"	1 x 15"
Dimensioni	inch	19 x 29,8 x 16,8	19 x 29,8 x 16,8
Peso (LxAxP)	Lb.	62,4	57,3
Connettori di ingresso		XLR	2 x speakon

SPECIFICHE TECNICHE

Hi MaxX100Sa

<i>TYPE</i>	<i>way</i>	BANDPASS
<i>BUILT-IN AMPLIFIER</i>	W rms	900
<i>FREQUENCY RESPONSE</i>	@ -5dB	38Hz - 120Hz
<i>SENSITIVITY</i>	dB	102
<i>MAXIMUM SPL</i>	dB	133
<i>LOW FREQUENCY WOOFER</i>	<i>inc</i>	1 x 18"
<i>DIMENSIONS (W x H x D)</i>	<i>inc</i>	20.8" x 23.2" x 26.82
<i>WEIGHT (Lb)</i>	<i>Lb</i>	92.5
<i>INPUT CONNECTORS</i>		XLR with loop stereo
<i>POWER SUPPLY CABLE</i>	<i>inc</i>	196"



Important information for correct disposal of the product in accordance with EC Directive 2002/96/EC.

This product must not be disposed of as urban waste at the end of its working life. It must be taken to a special waste collection centre licensed by the local authorities or to a dealer providing this service. Separate disposal of electric and/or electronic equipment (WEEE) will avoid possible negative consequences for the environment and for health resulting from inappropriate disposal, and will enable the constituent materials to be recovered, with significant savings in energy and resources. As a reminder of the need to dispose of this equipment separately, the product is marked with a crossed-out wheeled dustbin.