

Soundweb™ London

BLU-50

Installation Guide

5040341-C



IMPORTANT SAFETY INSTRUCTIONS

	CAUTION RISK OF ELECTRIC SHOCK DO NOT OPEN	
ATTENTION: RISQUE DE CHOC ELECTRIQUE - NE PAS OUVRIR		
WARNING: TO REDUCE THE RISK OF FIRE OR ELECTRIC SHOCK DO NOT EXPOSE THIS EQUIPMENT TO RAIN OR MOISTURE		
ATTENTION: POUR RÉDUIRE LE RISQUE D'INCENDIE OU D'ÉLECTROCUTION N'EXPOSEZ PAS CET APPAREIL À LA PLUIE OU L'HUMIDITÉ		

The symbols shown above are internationally accepted symbols that warn of potential hazards with electrical products. The lightning flash with arrowpoint in an equilateral triangle means that there are dangerous voltages present within the unit. The exclamation point in an equilateral triangle indicates that it is necessary for the user to refer to the owner's manual.

These symbols warn that there are no user serviceable parts inside the unit. Do not open the unit. Do not attempt to service the unit yourself. Refer all servicing to qualified personnel. Opening the chassis for any reason will void the manufacturer's warranty. Do not get the unit wet. If liquid is spilled on the unit, shut it off immediately and take it to a dealer for service. Disconnect the unit during storms to prevent damage.

The following is indicative of low altitude use; do not use this product above 2000m.



U.K. MAINS PLUG WARNING

A molded mains plug that has been cut off from the cord is unsafe. Discard the mains plug at a suitable disposal facility.

NEVER UNDER ANY CIRCUMSTANCES SHOULD YOU INSERT A DAMAGED OR CUT MAINS PLUG INTO A 13 AMP POWER SOCKET.

Do not use the mains plug without the fuse cover in place. Replacement fuse covers can be obtained from your local retailer. Replacement fuses are 13 amps and **MUST** be ASTA approved to BS1362.



If you want to dispose this product, do not mix it with general household waste. There is a separate collection system for used electronic products in accordance with legislation that requires proper treatment, recovery and recycling.

Private households in the 25 member states of the EU, in Switzerland and Norway may return their used electronic products free of charge to designated collection facilities or to a retailer (if you purchase a similar new one).

For Countries not mentioned above, please contact your local authorities for a correct method of disposal.

By doing so you will ensure that your disposed product undergoes the necessary treatment, recovery and recycling and thus prevent potential negative effects on the environment and human health.

WARNING FOR YOUR PROTECTION READ THE FOLLOWING:

READ THESE INSTRUCTIONS.

KEEP THESE INSTRUCTIONS.

HEED ALL WARNINGS.

FOLLOW ALL INSTRUCTIONS.

DO NOT USE THIS APPARATUS NEAR WATER.

CLEAN ONLY WITH A DRY CLOTH.

FOR INDOOR USE ONLY.

DO NOT BLOCK ANY OF THE VENTILATION OPENINGS. INSTALL IN ACCORDANCE WITH THE MANUFACTURER'S INSTRUCTIONS.

DO NOT INSTALL NEAR ANY HEAT SOURCES SUCH AS RADIATORS, HEAT REGISTERS, STOVES, OR OTHER APPARATUS (INCLUDING AMPLIFIERS) THAT PRODUCE HEAT.

ONLY USE ATTACHMENTS/ACCESSORIES SPECIFIED BY THE MANUFACTURER.

UNPLUG THIS APPARATUS DURING LIGHTNING STORMS OR WHEN UNUSED FOR LONG PERIODS OF TIME.

Do not defeat the safety purpose of the polarized or grounding-type plug. A polarized plug has two blades with one wider than the other. A grounding type plug has two blades and a third grounding prong. The wide blade or third prong are provided for your safety. If the provided plug does not fit your outlet, consult an electrician for replacement of the obsolete outlet.

Protect the power cord from being walked on or pinched particularly at plugs, convenience receptacles, and the point where they exit from the apparatus.

Use only with the cart stand, tripod bracket, or table specified by the manufacture, or sold with the apparatus. When a cart is used, use caution when moving the cart/apparatus combination to avoid injury from tip-over.



Refer all servicing to qualified service personnel. Servicing is required when the apparatus has been damaged in any way, such as power-supply cord or plug is damaged, liquid has been spilled or objects have fallen into the apparatus, the apparatus has been exposed to rain or moisture, does not operate normally, or has been dropped.

POWER ON/OFF SWITCH: The Power switch used in this piece of equipment DOES NOT break the connection from the mains.

MAINS DISCONNECT: The plug shall remain readily operable. For rack-mount or installation where plug is not accessible, an all-pole mains switch with a contact separation of at least 3 mm in each pole shall be incorporated into the electrical installation of the rack or building.

If connected to 240V supply, a suitable CSA/UL certified power cord shall be used for this supply.

This equipment is intended for rack mount use only.

IMPORTANT SAFETY INSTRUCTIONS

ELECTROMAGNETIC COMPATIBILITY

This device complies with part 15 of the FCC Rules and the Product Specifications noted on the **Declaration of Conformity**. Operation is subject to the following two conditions:

- this device may not cause harmful interference, and
- this device must accept any interference received, including interference that may cause undesired operation.

Operation of this unit within significant electromagnetic fields should be avoided.

- use only shielded interconnecting cables.

SAFETY INSTRUCTIONS

NOTICE FOR CUSTOMERS IF YOUR UNIT IS EQUIPPED WITH A POWER CORD.

WARNING: THIS APPLIANCE SHALL BE CONNECTED TO A MAINS SOCKET OUTLET WITH A PROTECTIVE EARTHING CONNECTION.

THE CORES IN THE MAINS LEAD ARE COLOURED IN ACCORDANCE WITH THE FOLLOWING CODE:

GREEN AND YELLOW - EARTH BLUE - NEUTRAL BROWN - LIVE

AS COLOURS OF THE CORES IN THE MAINS LEAD OF THIS APPLIANCE MAY NOT CORRESPOND WITH THE COLOURED MARKINGS IDENTIFYING THE TERMINALS IN YOUR PLUG, PROCEED AS FOLLOWS:

- THE CORE WHICH IS COLOURED GREEN AND YELLOW MUST BE CONNECTED TO THE TERMINAL IN THE PLUG MARKED WITH THE LETTER E, OR WITH THE EARTH SYMBOL, OR COLOURED GREEN, OR GREEN AND YELLOW.
- THE CORE WHICH IS COLOURED BLUE MUST BE CONNECTED TO THE TERMINAL MARKED N OR COLOURED BLACK.
- THE CORE WHICH IS COLOURED BROWN MUST BE CONNECTED TO THE TERMINAL MARKED L OR COLOURED RED.

THIS EQUIPMENT MAY REQUIRE THE USE OF A DIFFERENT LINE CORD, ATTACHMENT PLUG, OR BOTH, DEPENDING ON THE AVAILABLE POWER SOURCE AT INSTALLATION. IF THE ATTACHMENT PLUG NEEDS TO BE CHANGED, REFER SERVICING TO QUALIFIED SERVICE PERSONNEL WHO SHOULD REFER TO THE TABLE BELOW. THE GREEN/YELLOW WIRE SHALL BE CONNECTED DIRECTLY TO THE UNITS CHASSIS.

CONDUCTOR		WIRE COLOR	
		Normal	Alt
L	LIVE	BROWN	BLACK
N	NEUTRAL	BLUE	WHITE
E	EARTH GND	GREEN/YEL	GREEN

WARNING: IF THE GROUND IS DEFEATED, CERTAIN FAULT CONDITIONS IN THE UNIT OR IN THE SYSTEM TO WHICH IT IS CONNECTED CAN RESULT IN FULL LINE VOLTAGE BETWEEN CHASSIS AND EARTH GROUND. SEVERE INJURY OR DEATH CAN THEN RESULT IF THE CHASSIS AND EARTH GROUND ARE TOUCHED SIMULTANEOUSLY.

WARNING:

- APPARATET MÅ TILKOPLES JORDET STIKKONTAKT.
- APPARATEN SKALL ANSLUTAS TILL JORDAT UTTAG.
- LAITE ON LIITETTÄVÄ SUOJAKOSKETTIMILLA VARUSTETTUUN PISTORASIAAN.
- APPARATET SKAL TILSLUTTES JORDET STIKKONTAKT.

DECLARATION OF CONFORMITY

Manufacturer's Name: BSS Audio
Manufacturer's Address: 10653 South River Front Parkway,
Suite 300
South Jordan, Utah 84095, USA

declares that the product:

Product name: BLU 50
Note: Product name may be suffixed by the EU.

Product option: None

conforms to the following Product Specifications:

Safety: IEC 60065 -01+Amd 2

EMC: EN 55022:2006
EN 55024:1998
FCC Part 15

Supplementary Information:

The product herewith complies with the requirements of the:
Low Voltage Directive 2006/95/EC
EMC Directive 2004/108/EC
RoHS Directive 2011/65/EC
WEEE Directive 2002/96/EC

With regard to Directive 2005/32/EC and EC Regulation 1275/2008 of 17 December 2008, this product is designed, produced, and classified as Professional Audio Equipment and thus is exempt from this Directive.

Rex C. Reed
Director, Engineering
Signal Processing
10653 South River Front Parkway,
Suite 300
South Jordan, Utah 84095, USA
Date: March 7, 2014

European Contact: Your local BSS Audio Sales and Service Office or:

Harman Signal Processing
10653 South River Front Parkway,
Suite 300
South Jordan, Utah 84095, USA
Ph: (801) 566-8800
Fax: (801) 568-7583

CONSIGNES DE SÉCURITÉ IMPORTANTES

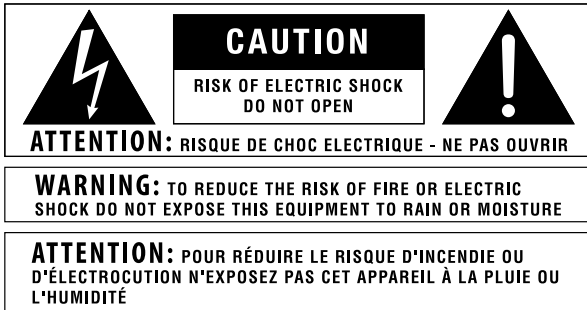

Les symboles illustrés ci-dessus sont des symboles acceptés internationalement qui avertissent des dangers potentiels relatifs à l'utilisation de produits électriques. Le voyant clignotant avec une flèche dans un triangle équilatéral signifie la présence de tensions dangereuses dans l'appareil. Le point d'exclamation dans un triangle équilatéral indique que l'utilisateur doit se référer au manuel d'utilisation.

Ces symboles indiquent qu'il n'y a aucune pièce utilisable par l'utilisateur à l'intérieur de l'appareil. Ne pas ouvrir l'appareil. Ne pas essayer de réparer soi-même l'appareil. Confier toute réparation à du personnel qualifié. Ouvrir la structure de l'appareil pour quelque raison que ce soit annulera la garantie du fabricant. Ne pas mouiller l'appareil. Si du liquide est renversé sur l'appareil, fermer immédiatement l'appareil et l'apporter chez un réparateur. Débrancher l'appareil pendant les tempêtes afin d'éviter des dommages.

Ce qui suit est représentatif d'une utilisation à basse altitude ; ne pas utiliser ce produit au-dessus de 2000 m.



AVERTISSEMENT CONCERNANT LA FICHE SECTEUR

Une fiche secteur moulée qui a été coupée du cordon est dangereuse. Jeter la fiche secteur dans un centre de déchets adapté.

VOUS NE DEVEZ EN AUCUNE CIRCONSTANCE INSÉRER UNE FICHE ENDOMMAGÉE OU COUPÉE DANS UNE PRISE SECTEUR 13 AMP.

Ne pas utiliser la fiche secteur si le couvercle du coffret à fusibles n'est pas bien en place. Vous pouvez vous procurer des capots de fusible de rechange auprès de votre détaillant local. Les fusibles de remplacement sont de 13 A et DOIVENT être approuvés ASTA, BS1362.



Ne pas jeter ce produit avec les ordures ménagères. Il existe un système de collecte sélective pour les produits électroniques usagés en conformité avec les lois en vigueur en matière de traitement, de récupération et de recyclage.

Dans les 25 États membres de l'UE, en Norvège et en Suisse, les ménages peuvent envoyer leurs produits électroniques usagés sans frais vers des centres de collecte sélective ou chez un distributeur (contre l'achat d'un nouveau produit).

Contactez les autorités locales pour connaître les procédures de traitement des déchets adaptées dans les pays non mentionnés ci-dessus.

Non seulement cette précaution vous permettra d'être sûr que votre produit est correctement traité, récupéré et recyclé, mais elle vous évitera également de nuire involontairement à l'environnement et à la santé humaine.

AVERTISSEMENT POUR VOTRE SÉCURITÉ LIRE ATTENTIVEMENT :

LIRE CES CONSIGNES.

CONSERVER CES CONSIGNES.

RESPECTER TOUS LES AVERTISSEMENTS.

SUIVRE TOUTES LES CONSIGNES.

NE PAS UTILISER CET APPAREIL PRÈS DE L'EAU.

NETTOYER UNIQUEMENT AVEC UN CHIFFON SEC.

POUR USAGE INTÉRIEUR UNIQUEMENT.

NE PAS OBSTRUER LES OUIËS D'AÉRATION. EFFECTUER L'INSTALLATION CONFORMÉMENT AUX INSTRUCTIONS DU FABRICANT.

NE PAS INSTALLER À PROXIMITÉ DE SOURCES DE CHALEUR TELLES QUE DES RADIATEURS, BOUCHES D'AÉRATION, PLAQUES CHAUFFANTES OU TOUT AUTRE APPAREIL (Y COMPRIS DES AMPLIFICATEURS) DÉGAGEANT DE LA CHALEUR.

UTILISER UNIQUEMENT LES PIÈCES/ACCESSOIRES MENTIONNÉS PAR LE FABRICANT.

DÉBRANCHER L'APPAREIL AU COURS DES ORAGES OU EN CAS DE NON-UTILISATION PENDANT UNE DURÉE PROLONGÉE.

Ne pas détériorer la sécurité de la fiche polarisée ou de la fiche de terre. Les fiches polarisées sont équipées de deux bornes de largeurs différentes. Les fiches de terre comportent deux lames et une troisième broche de mise à la terre. La broche la plus large ou troisième broche de mise à la terre est prévue pour votre sécurité. Si la fiche fournie ne correspond pas à votre installation électrique, faire appel à un électricien pour remplacer la prise hors normes.

Protéger le cordon d'alimentation contre les risques de piétinement ou de pincement, notamment au niveau des fiches, des prises de courant et du point d'attache avec le matériel.

Utiliser uniquement le chariot, le support, le trépied ou la table spécifié(e) par le fabricant ou vendu(e) avec le matériel. Si vous utilisez un chariot pour déplacer l'appareil, soyez suffisamment prudent pour éviter une éventuelle blessure consécutive au basculement du chariot et de sa charge.



Les réparations doivent être confiées à un technicien S.A.V. qualifié. Une réparation est nécessaire en cas de dommage quelconque et en particulier en cas d'endommagement du cordon d'alimentation ou de la fiche électrique, d'infiltration liquide, d'introduction involontaire d'un objet dans l'appareil, d'exposition de l'appareil à la pluie ou à un milieu humide, de fonctionnement anormal ou de chute de l'appareil.

INTERRUPTEUR MARCHÉ/ARRÊT : l'interrupteur d'alimentation de cet équipement NE coupe PAS la connexion secteur.

DÉBRANCHEMENT DE L'APPAREIL : la prise de courant doit rester facilement accessible. Pour un montage en rack ou une installation avec une prise inaccessible, un interrupteur omnipolaire à distance d'ouverture de contact d'au moins 3 mm doit être intégré à l'installation électrique du rack ou du local.

Si le matériel est relié à une alimentation de 240 V, utiliser impérativement un cordon d'alimentation adapté certifié CSA/UL pour ce branchement.

Cet équipement est exclusivement destiné à un montage en rack.

CONSIGNES DE SÉCURITÉ IMPORTANTES

COMPATIBILITÉ ÉLECTROMAGNÉTIQUE

Cet appareil est conforme au volet 15 des règles du FCC et aux spécifications techniques évoquées dans la **Déclaration de conformité**. Son fonctionnement est soumis aux deux conditions suivantes :

- cet appareil ne doit pas causer d'interférences nuisibles et
- cet appareil doit accepter les interférences captées, y compris les interférences susceptibles de nuire à son fonctionnement.

L'utilisation de cet appareil à proximité de champs électromagnétiques puissants n'est pas recommandée.

- utiliser exclusivement des câbles d'interconnexion blindés.

CONSIGNES DE SÉCURITÉ

NOTICE ADRESSÉE AUX CONSOMMATEURS ÉQUIPÉS D'UN MATÉRIEL AVEC CORDON D'ALIMENTATION FOURNI.

AVERTISSEMENT : CET APPAREIL DOIT ÊTRE BRANCHÉ SUR UNE PRISE SECTEUR DOTÉE D'UNE PROTECTION PAR MISE À LA TERRE.

LES COULEURS DES NOYAUX DANS LES FILS SECTEURS DOIVENT RESPECTER LES CODES SUIVANTS :

VERT ET JAUNE - TERRE BLEU - NEUTRE MARRON - PHASE

LES COULEURS DES NOYAUX DANS LES FILS SECTEURS DE CET APPAREIL PEUVENT NE PAS CORRESPONDRE AUX INSCRIPTIONS COLORÉES IDENTIFIANT LES TERMINAUX DANS VOTRE FICHE ; IL FAUT DONC PROCÉDER DE LA FAÇON SUIVANTE :

- LE NOYAU VERT ET JAUNE DOIT ÊTRE BRANCHÉ AU TERMINAL DE LA FICHE OÙ APPARAÎT LA LETTRE E OU LE SYMBOLE DE MISE À LA TERRE, OU AU TERMINAL VERT OU VERT ET JAUNE.
- LE NOYAU BLEU DOIT ÊTRE BRANCHÉ AU TERMINAL MARQUÉ D'UN N OU DE COULEUR NOIRE.
- LE NOYAU MARRON DOIT ÊTRE BRANCHÉ AU TERMINAL MARQUÉ D'UN L OU DE COULEUR ROUGE.

CE MATÉRIEL PEUT NéCESSITER L'UTILISATION D'UN CORDON D'ALIMENTATION DIFFÉRENT ET/OU D'UNE FICHE DE BRANCHEMENT DIFFÉRENTE SELON LA SOURCE D'ALIMENTATION DISPONIBLE À L'INSTALLATION. SI LA FICHE DE BRANCHEMENT DOIT ÊTRE CHANGÉE, FAIRE APPEL À UN TECHNICIEN QUALIFIÉ QUI DEVRA SE RÉFÉRER AU TABLEAU CI-DESSOUS. LE FIL VERT/JAUNE DOIT ÊTRE BRANCHÉ DIRECTEMENT AU CHÂSSIS DE L'APPAREIL.

CONNECTEURS		COULEUR DU FIL	
		Normal	Alt
L	PHASE	MARRON	NOIR
N	NEUTRE	BLEU	BLANC
E	TERRE	VERT/JAU	VERT

ATTENTION : UN DÉFAUT DE MISE À LA TERRE PEUT PROVOQUER CERTAINS DYSFONCTIONNEMENTS DE L'APPAREIL OU DU SYSTÈME AUQUEL IL EST RELIÉ, POUVANT SE TRADUIRE PAR UNE TENSION COMPOSÉE ENTRE LA MASSE ET LA PRISE DE TERRE. CELA PEUT PROVOQUER DES BLESSURES SÉRIEUSES OU FATALES SI LA MASSE ET LA PRISE DE TERRE SONT TOUCHÉES EN MÊME TEMPS.

ATTENTION :

- APPARATET MÅ TILKOPLES JORDET STIKKONTAKT.
- APPARATEN SKALL ANSLUTAS TILL JORDAT UTTAG.
- LAITE ON LIITETTÄVÄ SUOJAKOIKETTIMILLA VARUSTETTUUN PISTORASIAAN.
- APPARATET SKAL TILSLUTTES JORDET STIKKONTAKT.

DÉCLARATION DE CONFORMITÉ

Nom du fabricant : BSS Audio
Adresse du fabricant : 10653 South River Front Parkway,
Suite 300
South Jordan, Utah 84095, ÉTATS-UNIS

déclare que le produit :

Nom du produit : BLU 50
Remarque : Le nom du produit peut être suivi des lettres UE.

Option du produit : Aucune

est conforme aux spécifications suivantes :

Sécurité : CEI/IEC 60065:2001 + Amd 2

CEM : EN 55022:2006
EN 55024:1998
Partie 15 des FCC

Informations complémentaires :

Ce produit est conforme aux exigences suivantes :
Directive sur la basse tension 2006/95/CE
Directive 2004/108/CE
Directive RoHS 2011/65/UE
Directive DEEE 2002/96/CE

Ce produit appartenant à la catégorie Matériel audio professionnel, il n'est pas concerné par la directive 2005/32/CE ou par le règlement européen 1275/2008 du 17 décembre 2008.

Rex C. Reed
Directeur, Ingénierie
Traitement des signaux
10653 South River Front Parkway,
Suite 300
South Jordan, Utah 84095, ÉTATS-UNIS
Date : 7 mars 2014

Contact en Europe : votre revendeur BSS Audio local et le bureau d'assistance de :

Harman Signal Processing
10653 South River Front Parkway,
Suite 300
South Jordan, Utah 84095, ÉTATS-UNIS
Tél. : (801) 566-8800
Fax : (801) 568-7583

Table of Contents

- Regulatory Information..... 1**
- Product Registration/Warranty 1**
- Important User Information 1**
- Mechanical Installation..... 1**
- Mounting The BLU-50..... 2**
 - Rack Mounting 2
 - Under-Table Mounting..... 3
 - Wall Mounting..... 3
- Applying Power..... 4**
- Front Panel 5**
 - Input/Output Channel Monitoring 5
 - Clip..... 5
 - Signal..... 5
 - 48V..... 5
 - COM (Communications)..... 5
 - STAT (Status) 5
 - ERR (Error) 5
 - PWR (Power)..... 5
- Rear Panel 6**
 - 12-48VDC 25W [Power Connector] 6
 - Locate..... 6
 - RS232 6
 - PoE / Ethernet..... 6
 - BLU link 6
 - Analogue Input/Output Connections 6
- Audio Cable Wiring 7**
 - Audio Input and Output Wiring Convention..... 7
- Control Inputs..... 8**
 - 2-Wire Mode 8
 - 3-Wire Mode 8
- Logic Outputs 8**
- Opto Output..... 9**
- Technical Specifications..... 10**



Regulatory Information

An example of this equipment has been tested and found to comply with the following European and international Standards for Electromagnetic Compatibility and Electrical Safety:

Radiated Emissions (EU): EN55013 (2001+A1)
Immunity (EU): EN55020 (1998)
Electrical Safety (EU): IEC60065-01 + AMD1
Electrical Safety (USA): UL60065-06



Product Registration/Warranty

To register your product, please visit http://bssaudio.com/en-US/support/warranty_registration.
For warranty information, please visit http://bssaudio.com/en-US/support/warranty_policy.

Important User Information

Do not remove covers. No user serviceable parts inside, refer servicing to qualified service personnel. For continued compliance with international EMC regulations, it is important that all cables be screened, and connected as follows: Audio cable screens to their BLU-50 connector ground. Control cable screens to the ground screws adjacent to the connector. Network cables should be of type Cat 5, fitted with a clip-on ferrite sleeve (STEWART TYPE 28A2029-0A0) near the network socket end. This equipment must be earthed. It should not be necessary to remove any protective earth or signal cable shield connections to prevent ground loops. Any such disconnections are outside the recommended practice of BSS Audio, and will render the EMC or safety certificate void.

Mechanical Installation

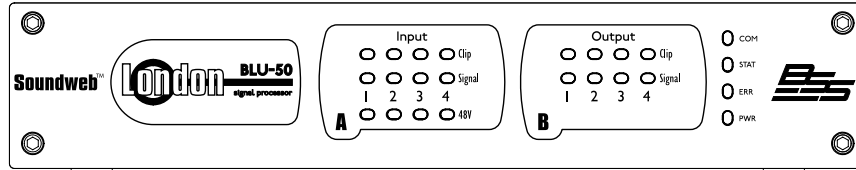

The BLU-50 must be installed according to the guidelines laid out in this document. Damage caused to the BLU-50 resulting from a failure to follow these guidelines is not covered by the warranty.



Mounting The BLU-50

Rack Mounting

To rack mount the BLU-50, first affix the rack ears (included) to both sides of the BLU-50 using two screws (included) per side. The BLU-50 can then be installed into a standard 1U rack space using four rack screws (included).

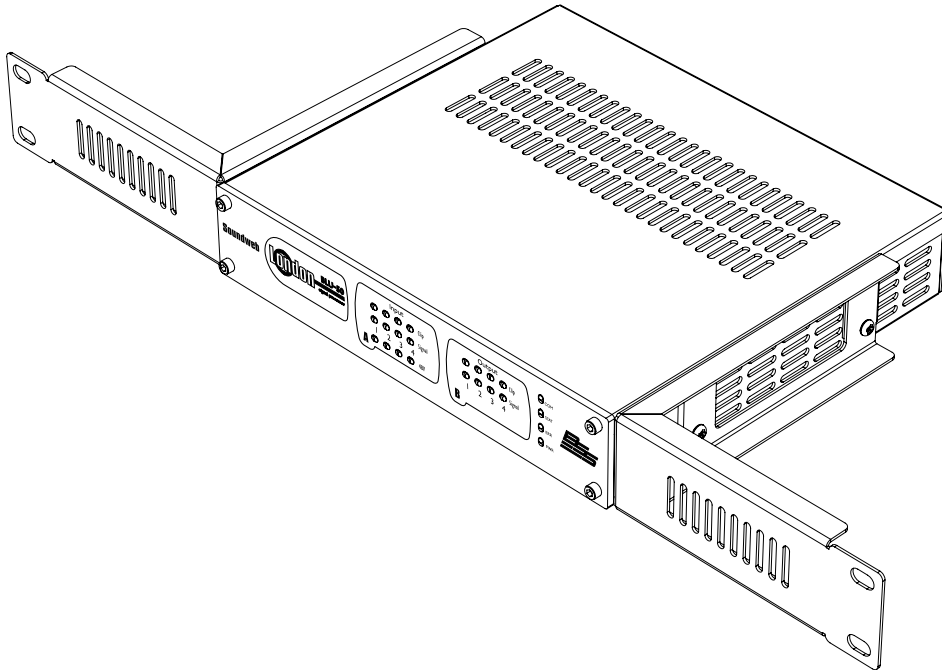

When installing the BLU-50 into a rack, it is recommended that one empty rack space is left above and below the device. This allows heat to safely dissipate. Furthermore, DO NOT attempt to install two BLU-50 devices side-by-side into the same 1U rack space – doing so will prevent heat from safely dissipating. See the below diagram for further clarification.

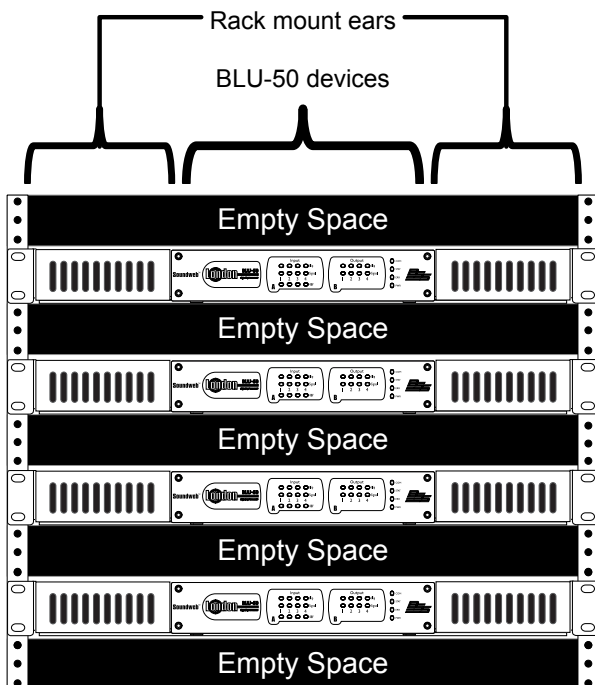

To prevent cosmetic damage to the finish on the rack mount ears, use protective plastic cups (provided) under the rack mounting screws (provided).

Under-Table Mounting

Additional Tools & Supplies Required

- Phillips screwdriver
- ½" minimum length #8 Phillips screws (quantity 4)

Step 1: Affix the mounting brackets (included) to both sides of the BLU-50 using two screws (included) per side.

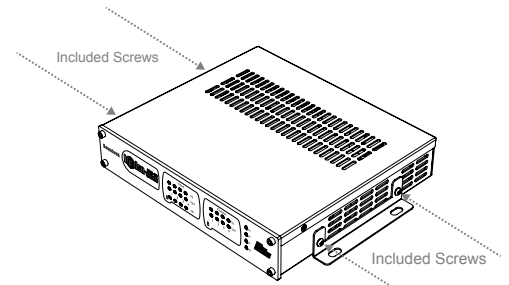

Step 2: Install the BLU-50 under the table upside down as shown, using four #8 screws with a minimum length of ½" (not included). When under-table mounting the BLU-50, you must:

- Mount the device so that the lid vents face away from the table.

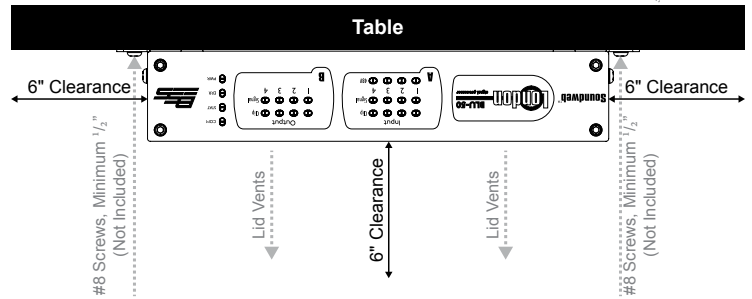

- Leave at least 6" of clearance on each side and the top of the device to allow for proper ventilation.
- Use four #8 wall-mounting screws of at least ½" in length.

Wall Mounting

Additional Tools & Supplies Required

- Phillips screwdriver
- 1½" minimum length #8 Phillips screws (quantity 4)
- Hollow wall anchors (quantity 2)

Step 1: Affix the mounting brackets (included) to both sides of the BLU-50 using two screws (included) per side.

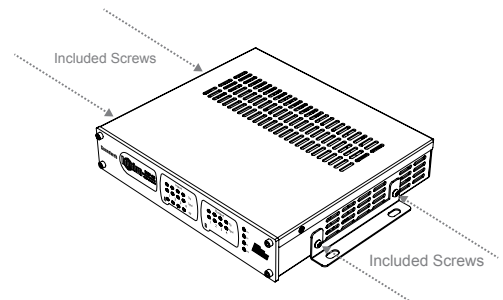

Step 2: Install the BLU-50 to the wall using four additional #8 screws with a minimum length of 1½" (not included). When wall mounting the BLU-50, you must:

- Mount the device so that the sides face up and down and the lid vents face away from the wall.
- Leave at least 6" of clearance on each side and the top of the device to allow for proper ventilation.
- Use four #8 wall-mounting screws of at least 1½" in length.
- Mount 2 of the wall-mounting screws into the wall studs.
- Use hollow wall anchors of suitable size and length for the two remaining wall-mounting screws.

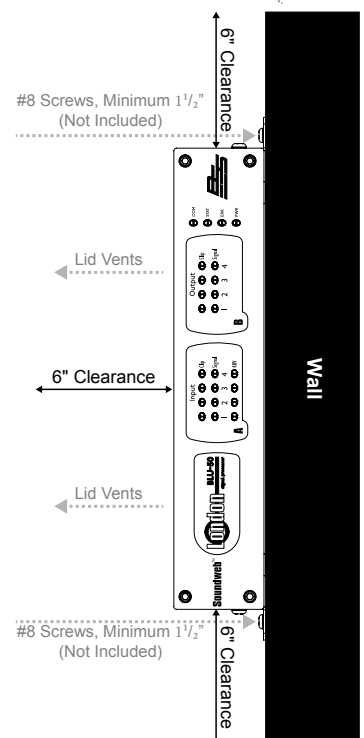

IMPORTANT!

Power Supply Wiring Instructions



ATTENTION! Please follow these power supply wiring instructions to prevent damage to the BLU-50 device. The white wire **MUST** be connected to the + terminal and the black wire **MUST** be connected to the - terminal using the provided Euroblock connector.

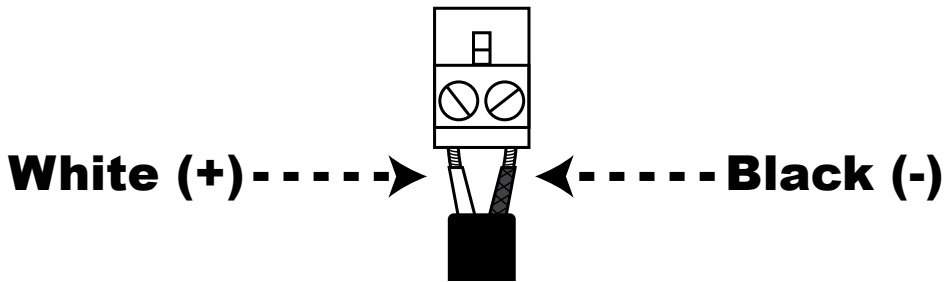
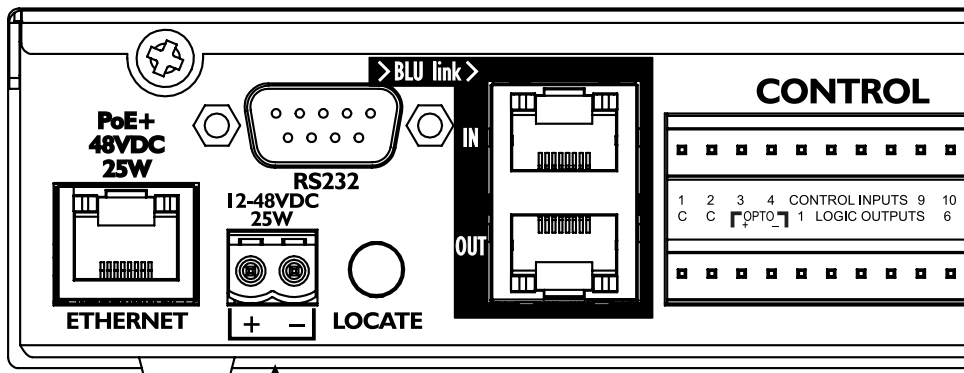

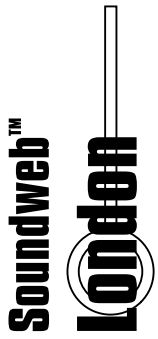

Front Panel

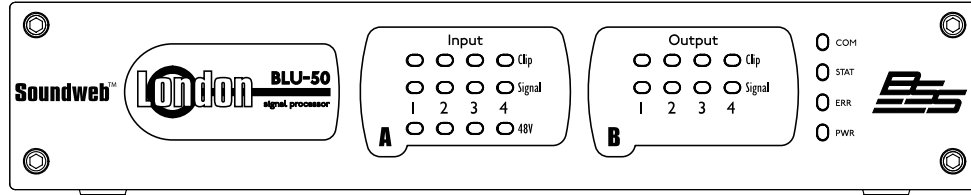

Input/Output Channel Monitoring

Each channel in the input section has the following LED indicators:

The output section has the same LEDs, without the 48V LED indicators.

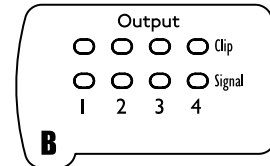
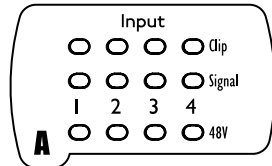

Clip

Indicates clipping in the analogue domain for each input or output channel. The LED will illuminate at +18.5dB.

Signal

The Signal LED will illuminate for each input or output channel when the signal reaches or exceeds the signal threshold of -20dB.

Input channels have a third indicator:

48V

(Input channels only) Illuminates to indicate +48V phantom power has been activated for the relevant input channel.

COM (Communications)

The COM LED turns green to indicate a normal linked condition. The COM LED blinks green if data is being transferred on the Ethernet or RS232 port. The LED turns yellow if a link is established but no IP address has been established.



STAT (Status)

The STAT LED turns green when a valid design file is loaded and running. The STAT LED turns yellow when the design is paused. The STAT LED turns red when the design is stopped.



ERR (Error)

The ERR LED is normally off. It turns red in the case of a critical or fatal error.



PWR (Power)

The PWR LED turns blue when the device is powered on. It blinks during locate operations (both when pressing the locate button on the rear of the device and also when locating the device from within the software).



Rear Panel

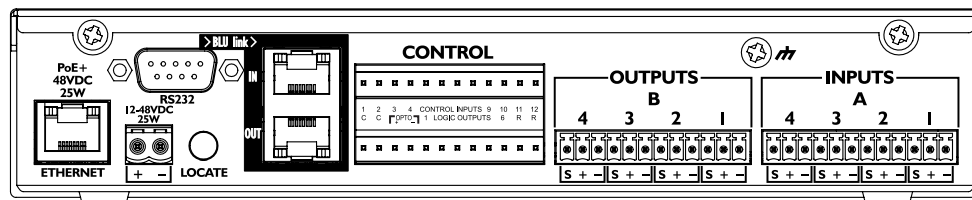

12-48VDC 25W [Power Connector]

The BLU-50 can be powered via either an external universal 12VDC power supply (included), 12-48VDC 30W supply, or via PoE+. Connect the 12VDC power supply here if not using PoE+.

This model shall be powered by a certified AC/DC power adapter with limited power source output rated 12V-48V, 30W maximum or a certified PoE+ adapter limited power source output rated 48VDC, 30W maximum. The unit may be supplied together with a certified AC/DC power adapter from FranMar International Inc., model FRA030E-S12-4, rated 100-240V~, 50-60Hz, 0.7A, Class I.

Locate

Pressing the Locate switch on the rear of the unit will illuminate the PWR LED on the front and identify the device within London Architect. Similarly the switch will illuminate if the device is located from within London Architect.

RS232

Serial port for connection of external control equipment.

PoE / Ethernet

If not using a 12VDC power supply, power the BLU-50 via PoE+ here. This can be accomplished by either using a PoE+ compliant network switch, or a PoE+ midspan injector. This is also the main connection for the proprietary system control network, and for third-party Ethernet control.

BLU link

London BLU link is a point-to-point digital audio bus with 256 audio channels at 48K sample rate or 128 audio channels at 96K sample rate. The BLU-50 allows access to channels 1-48 of this bus, at 48K sample rates. The physical connection is made with Cat 5e cable from the OUT port of one device to the IN port of another device. The devices are connected in a daisy chain fashion continuing with the OUT port of one device connected to the IN port of the next device. Redundancy can be provided by completing the loop and connecting the OUT port from the last device to the IN port of the first device in the chain. All devices connected in the London BLU link chain must be configured for the same audio sample rate.

Analogue Input/Output Connections

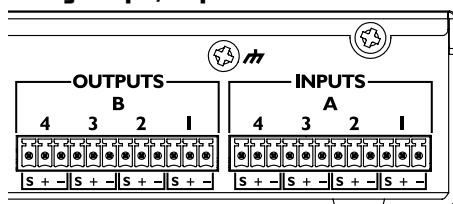

There are 4 analogue input connections and 4 analogue output connections. The analogue connections are balanced, on Phoenix/Combicon connectors.

Audio Cable Wiring

All audio and GPIO connections to the BLU-50 are via Klippon pluggable terminal block connectors (also known as BL, Phoenix or Combicon). 12-way female Klippon connectors are supplied for making these connections.

Audio Input and Output Wiring Convention

Soundweb products provide cable shielding 'back from the destination' to eliminate ground loop problems. This means that the shield (S) connection on an input is grounded, whereas the shield connection on an output is floating (although connected via an internal network to ground for EMC compliance).

Balanced Wiring

The convention for balanced wiring (2-core plus shield) is shown here:

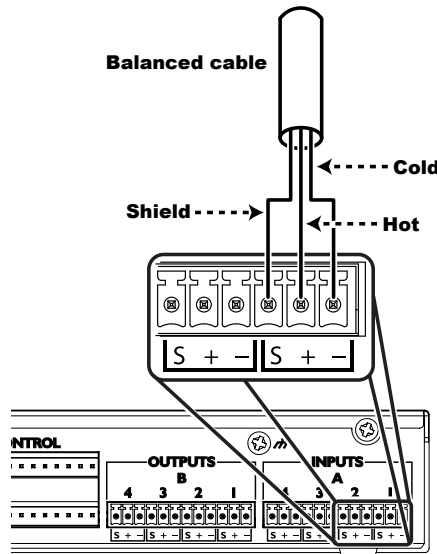

Unbalanced Wiring

The convention for unbalanced wiring to the inputs (1-core plus shield) is shown here:

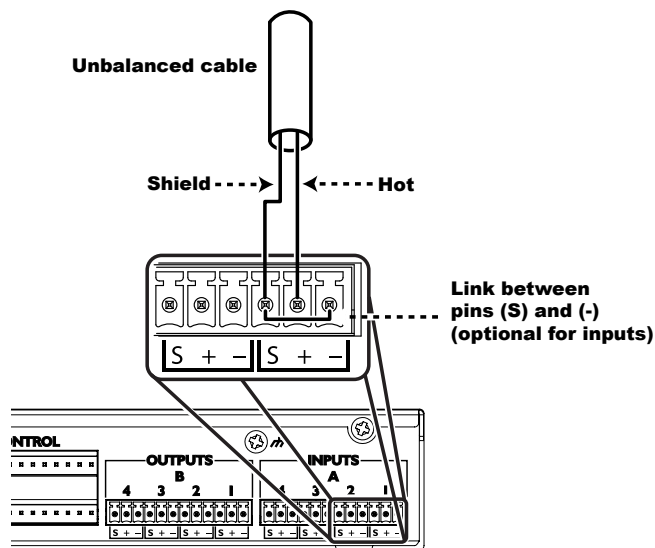

Control Inputs

CONTROL

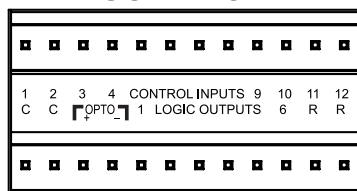

Used to connect switches or potentiometers, e.g. BLU-3 selector wallplate (Part no. Z-BLU-3). Looking at the control port connector (on the back of the unit), there are two common (ground) connections C to the left of the twelve CONTROL INPUTS and, two software assignable reference voltage outputs R to the right.

The control ports have two modes of operation: 2-wire and 3-wire.

2-Wire Mode

In this mode the twelve CONTROL INPUTS are internally 'pulled up' to +5V DC via a 4.7kOhm resistor. Therefore, no external voltage source is needed to create contact closure to ground for switches such as mute buttons or, resistance to ground (for other multi-state or continuous controls such as Parameter Presets or faders).

See the help file within HiQnet London Architect for a table of resistor values for use with Parameter Presets or source selectors.

Two 'common' ground connections are provided using the two C connectors to the left of the CONTROL INPUTS.

A 47kOhm-log potentiometer (Part no. DM10018) connected between a control input and common will allow parameters to be controlled linearly.

3-Wire Mode

This mode allows the use of linear pots or faders for continuous controls. A pot would be wired as a potential divider with the top of the track connected to the reference output R, the wiper to a control input and the bottom of the track to a common C. For good performance, pots with track resistance between 10K and 100KOhms are recommended.

Logic Outputs

Used to connect 'tally' indicator LED's or relays.

There are six standard LOGIC OUTPUTS which produce 0V or +5V DC via an internal 440 Ohm resistor and two internally connected common (ground) connections C.

An LED connected between one output (Anode, A) and common (Cathode, K) will illuminate when the LOGIC OUTPUT is activated, without requiring any external current limiting resistor.

A high sensitivity relay (such as a reed relay) may be driven by connecting four outputs in parallel. This arrangement will develop 4V across a 500-Ohm coil, providing that all four outputs are made logic 1 simultaneously.

Opto Output

In addition to the six standard LOGIC OUTPUTS, there is an isolated output, which fails safe (open circuit) if the unit becomes faulty.

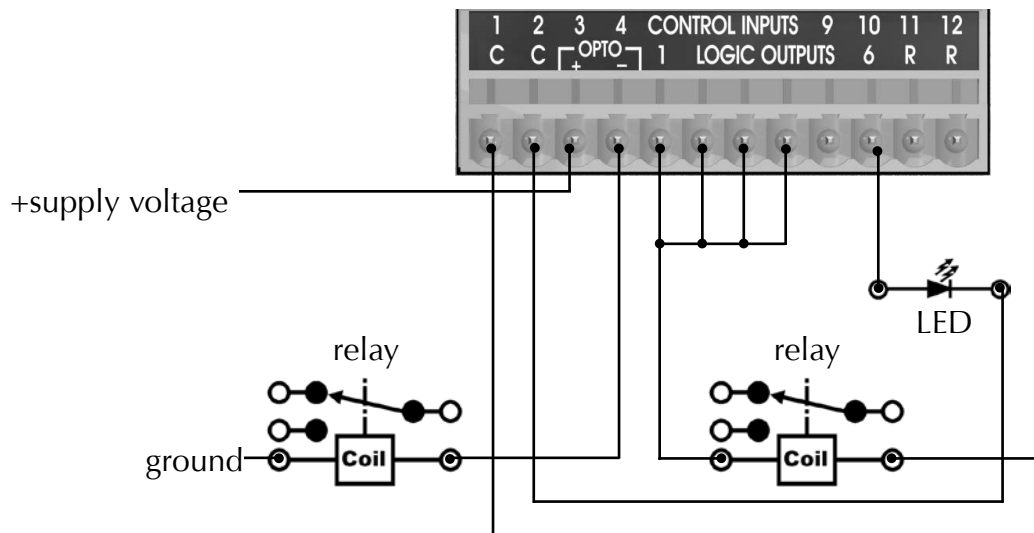
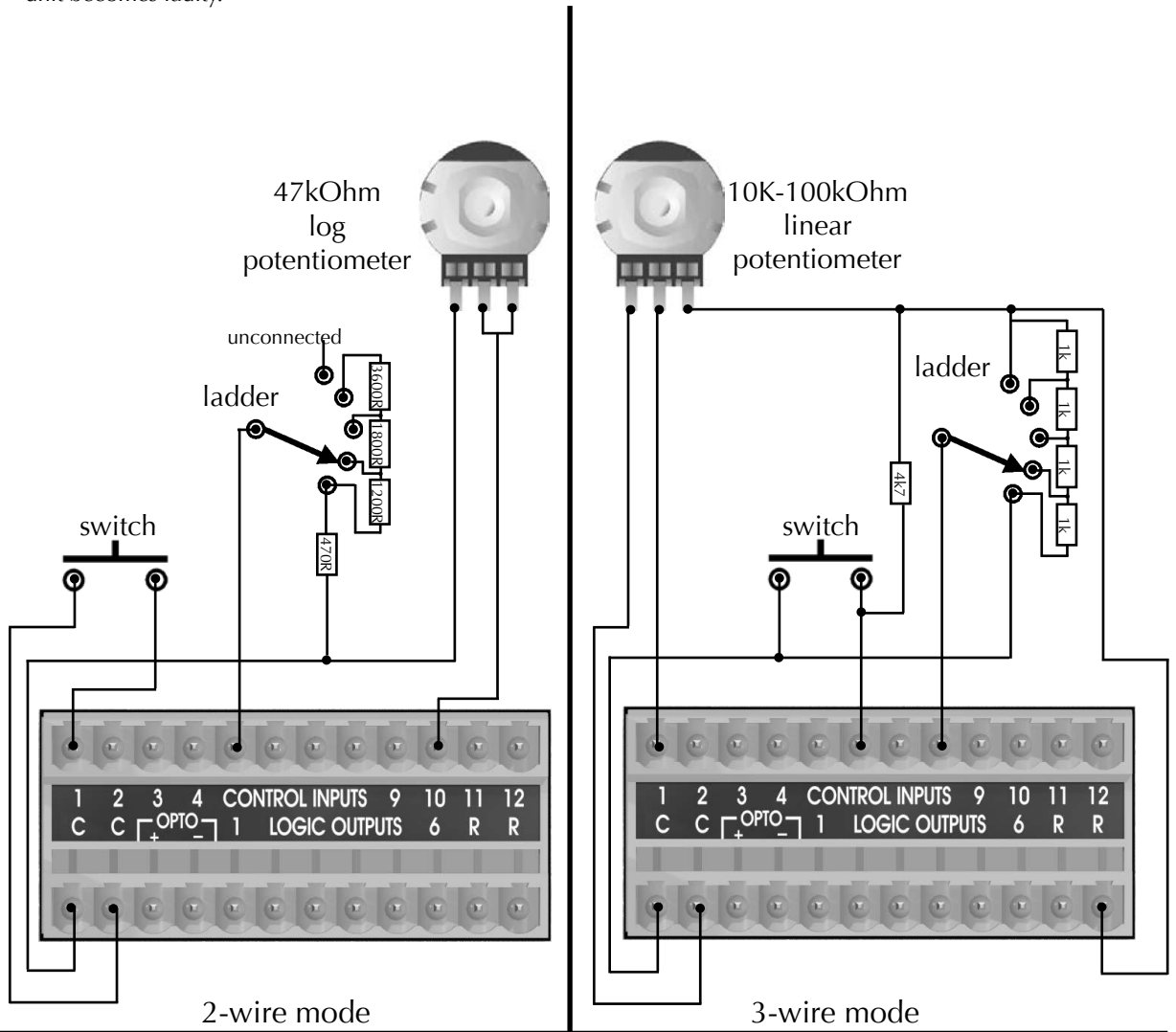

Technical Specifications

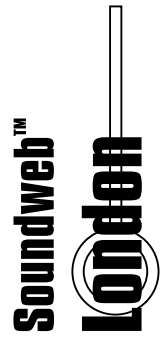

LED INDICATORS

Input/Output LED Indicators:	Signal Clip, Signal Present, 48V (input only)
Other LED Indicators:	Control link status and activity for Ethernet and RS-232 connections (COM) Device configuration status (STAT) Error (ERR) Power/Locate (PWR)

ANALOG INPUTS

Connectors:	4 electronically balanced on Phoenix/Combicon removable screw connectors
Mic/Line Inputs:	Nominal gain 0db, electronically switchable up to +48dB in +6dB steps
Equivalent Input Noise (E.I.N.):	<125dBu typical with 150Ω source
A/D Latency:	12.6/Fs (0.26mS @ 48k)
Input Impedance:	3.0kΩ
Maximum input level:	+20dBu with 0dB input gain, +8dBu with 12dB gain
CMRR:	>75dB at 1kHz
Phantom power:	48V nominal, selectable per input
Dynamic Range:	110dB A-weighted, >107dB unweighted
Sample Rate:	48kHz

ANALOG OUTPUTS

Connectors:	4 electronically balanced on Phoenix/Combicon removable screw connectors
Output Impedance:	120Ω
Maximum Output Level:	+19dBu
Frequency Response:	20Hz-20kHz (+0.5db/-1dB)
Dynamic Range:	>108dB typical (22Hz to 22kHz unweighted)
Crosstalk:	<-75dB
D/A Latency:	29/Fs (0.60ms) @ 48k)
Dynamic Range:	110dB A-weighted, 107dB unweighted
Sample Rate:	48kHz

SYSTEM PERFORMANCE

THD:	<0.01% (20Hz to 20kHz, +10dBu output)
Frequency Response:	20Hz – 20kHz, +/- 0.5 dB
Interchannel Crosstalk:	< -110dB, -120dB typical
Crosstalk input to output:	< -100dB

CONTROL PORTS

Inputs/Outputs:	12 inputs and 6 outputs
Control Input Voltage:	0 to 4.5V
Control Input Impedance:	4.7kΩ to +5V (2-wire mode), >1MΩ (3-wire mode)
Logic Output Voltage:	0 or +5V unloaded
Logic Output Impedance:	440Ω
Logic Output Current:	10mA source, 60mA sink





WATCHDOG OUTPUT

Type: Phoenix/Combicon connector for fail-safe control
Opto Output Current: 14mA maximum
Withstanding Voltage: 80V maximum (Off)
Series Impedance: 220Ω (Isolated)

CONTROL NETWORK

Connectors: RJ45 Ethernet connector
Maximum Cable Length: 100m/300ft on Category 5 cable between device and Ethernet switch

BLU LINK AUDIO NETWORK

Connectors: 2 x RJ45 Ethernet connectors
Maximum Cable Length: 100m/300ft on Category 5e cable between devices
Latency: 11/Fs [0.23ms@48k]
Pass Through Latency: 4/Fs [0.08ms@48k]
Maximum Number of Nodes: 60

POWER

Power Adapter: 12VDC, 30 watts, model part number PS1225DC/ST
(mains: 100-240VAC, 50/60Hz)
DC Input: 12-48V 30VA
BTU Rating: 85.3 BTU/hr
Operating Temperature Range: 0° to 45° C (32° to 113° F)

DIMENSIONS AND WEIGHT

Dimensions: 1.625" (41mm) X 8.63" (219mm) X 7.75" (197 mm)
Weight: 2.82lbs/1.28kg

BSS Audio incorporates high quality mechanical fans in some products. All mechanical fans have a limited life expectancy. We recommend annual inspection of fans for dust occlusion and excessive noise. Fan assemblies should be replaced after six to ten years of use. Environmental factors such as elevated temperature, dust, and smoke can adversely affect fan life. Systems exposed to these conditions should be inspected more frequently. Fan replacement can be performed either at the factory or by an experienced technician in the field. Please contact BSS Technical Support for more information on purchasing replacement parts or product service.

BSS Audio has a policy of continued product improvement and accordingly reserves the right to change features and specifications without prior notice.





Phone: (801) 566-8800

Website: bssaudio.com

Support: bssaudio.com/en-US/support

BSS Audio is a registered trademark of HARMAN

© 2016 HARMAN

All rights reserved

Printed in Malaysia