





HSC271, HSD271



SERVICE MANUAL / # 2955X00xxx / 01/17

HSC271 2955X00290
HSD271 2955X00270

Plates/Schilder

4812S00220 	4812S00210 
4812S00020 	4812S00010 
4812S00160 	

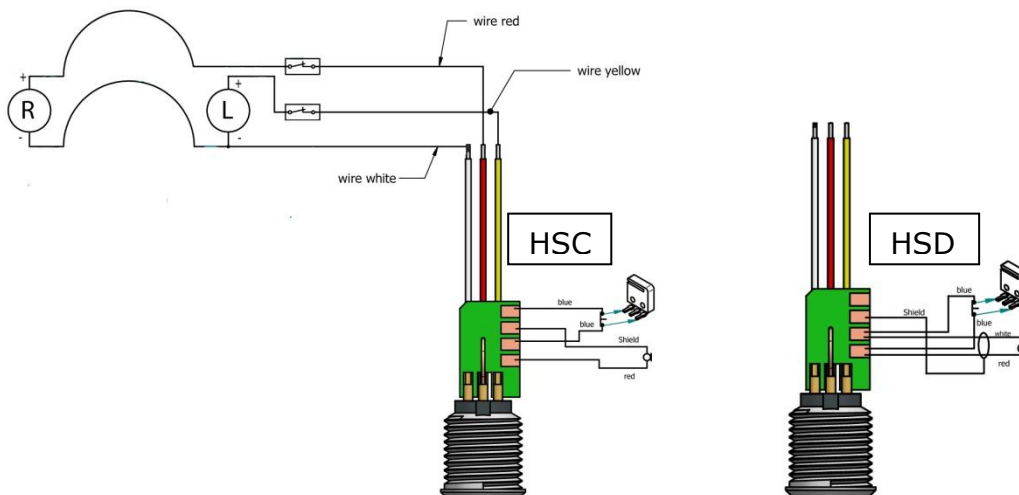
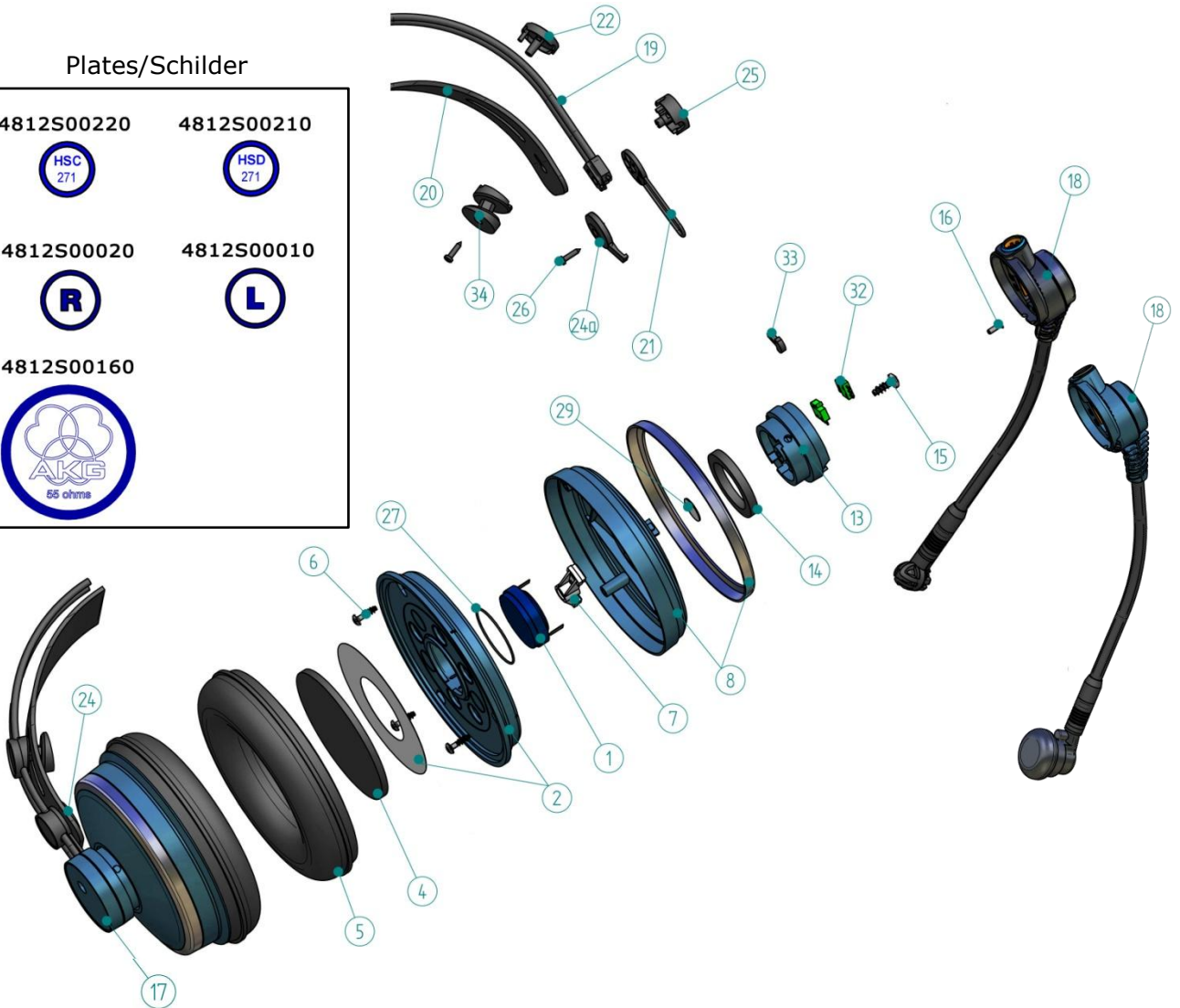

HSC Microphone boom assy. 2955M91120

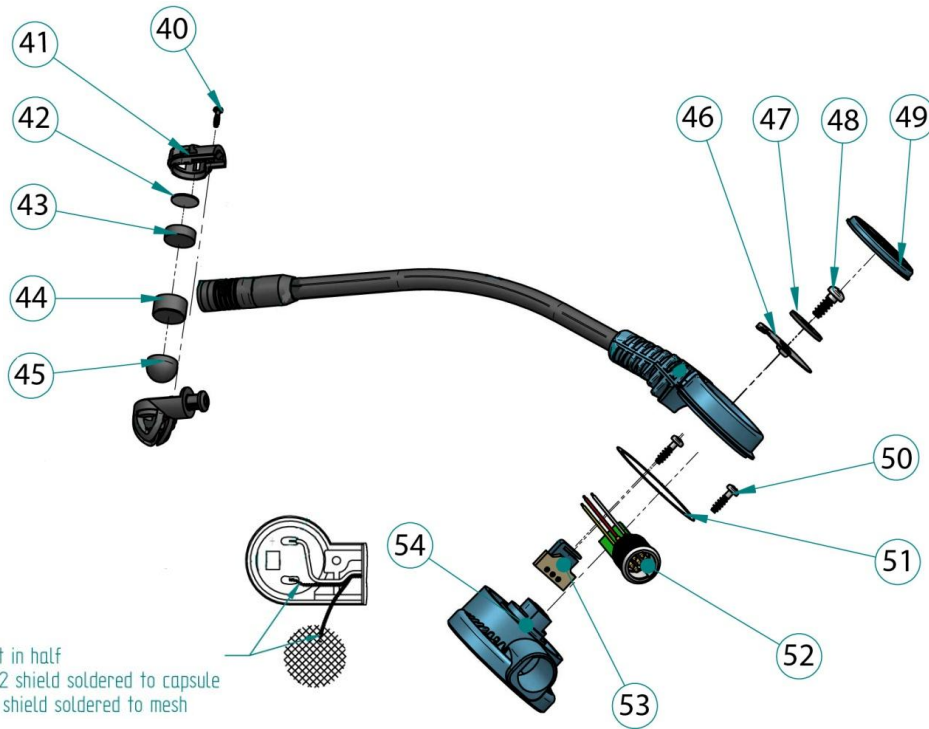

HSD Microphone boom assy. 2955M91110

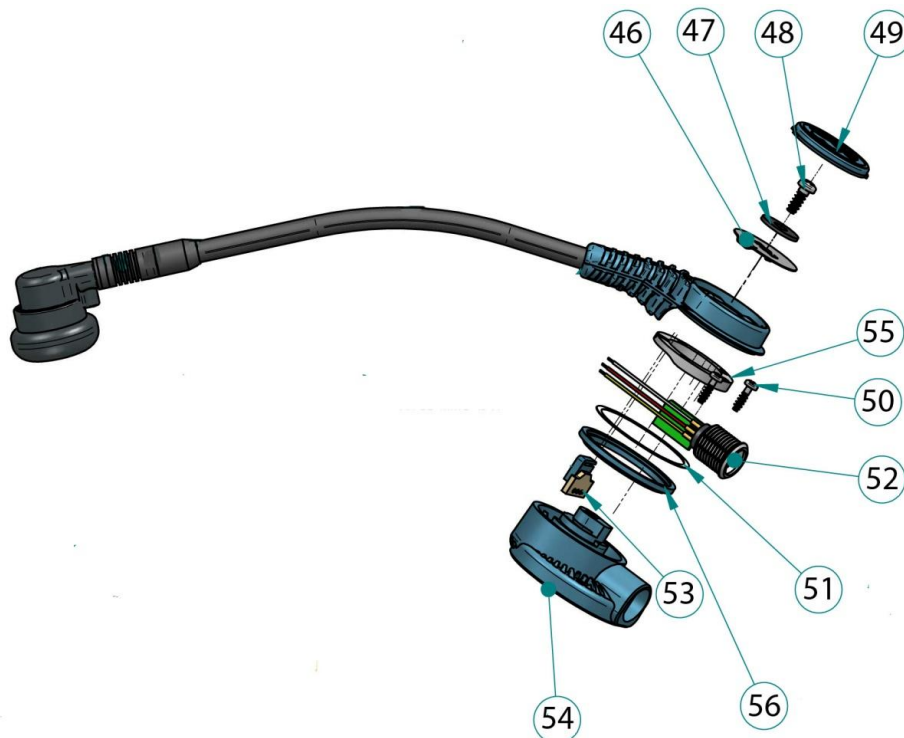

Parts list / Stückliste

Description	Pos.	Part number Bestellnummer	Quant./ Stück		Bezeichnung
			HSC271	HSD271	
Capsule XXL	1	2606B00050	2	2	Kapsel XXL
Capsule housing	2	2470M99020	2	2	Kapselgehäuse
Disk	4	2908Z12020	2	2	Scheibe
Cushion	5	2058Z10010	2	2	Ohrpolster
Cushion, velours	5	2955Z26010	(2)	(2)	Ohrpolster, Velour
Schraube Ejot 30x10	6	0099N30020	6	6	Schraube Ejot 30x10
Bass tube	7	2470Z21010	2	2	Baßrohr
Housing	8,29	2470M98020	2	2	Haube
Shell	13	2470Z20120	2	2	Topf
Foam strip	14	2123Z11010	2	2	Streifen
Screw Ejot 40x14	15	0099N40030	2	2	Schraube Ejot 40x14
Screw Ejot 22x8	16	0099N22130	2	2	Schraube Ejot 22x8
Cover right	17	2470Z19020	1	1	Deckel rechts
HSC Microphone boom	18	2955M91120	1	-	HSC Mikrofonarm
HSD Microphone boom	18	2955M91110	-	1	HSD Mikrofonarm
Outer headband	19	2040M02130	1	1	Bügel
Headband	20	2058Z35010	1	1	Bügelband
Rubber loop	21	2040M03030	2	2	Gummischlaufe
Cover	22	2040Z52010	2	2	Deckel
End disc right	24	2040Z18020	1	1	Scheibe rechts
End disc left	24a	2470Z06010	1	1	Scheibe links
Slider	25	2040Z17260	2	2	Führung
Screw Ejot 22x8	26	0099N22040	4	4	Schraube Ejot 22x8
Rubber ring	27	6000N00230	2	2	O-Ring 20x1
Switch	32	0040E01270	2	2	Schalter
Switch pin	33	2470Z07010	1	1	Schaltschieber
Wedge	34	2040Z36020	2	2	Führungskeil
Screw Ejot KB 15x5	40	0099N15000	1	-	Schraube Ejot KB 15x5
Capsule cover	41	2578Z13010	1	-	Kapselabdeckung
Screen	42	2656Z12010	1	-	Schirm
Windscreen rear	43	2578Z16030	1	-	Windschutz hinten
Capsule	44	0025E00470	1	-	Kapsel
Windscreen front	45	2578Z15030	1	-	Windschutz vorne
Locking disc	46	2955Z11010	1	1	Verriegelungsscheibe
Washer	47	9021D04300	1	1	Beilagscheibe
Screw Ejot KB 30x8	48	0099N30090	1	1	Schraube Ejot KB 30x8
Cover	49	2955Z13020	1	1	Abdeckung
Screw Ejot 22x8	50	0099N22040	2	2	Schraube Ejot 22x8
Slider ring	51	2955Z14010	1	1	Ring
XLR assy. HSD	52	2955L14020	-	1	XLR assy. HSD
XLR assy. HSC	52	2955L14030	1	-	XLR assy. HSC
Switch board	53	2955M03020	1	1	Schalter
Adapter HSC/HSD	54	2955Z15020	1	1	Adapter HSC/HSD
HSC/HSD disc	55	2955Z31010	1	1	HSC/HSD Scheibe
HSC/HSD ring	56	2955Z14010	1	1	HSC/HSD Ring